

ATOMIC STRUCTURE
• **AND**
SPECTRAL LINES

ATOMIC STRUCTURE AND SPECTRAL LINES

BY
ARNOLD SOMMERFELD

PROFESSOR OF THEORETICAL PHYSICS AT THE UNIVERSITY OF MUNICH

TRANSLATED FROM THE THIRD GERMAN EDITION BY

HENRY L. BROSE, M.A.

CHRIST CHURCH, OXFORD

WITH 125 FIGURES

METHUEN & CO. LTD.
36 ESSEX STREET W.C.
LONDON

This Translation First Published in 1923

PRINTED IN GREAT BRITAIN

PREFACE TO THE THIRD GERMAN EDITION

WHEREAS the second edition (September, 1920) differed essentially only in the mathematical notes from the first edition, the third edition is a complete revision.

My aim was, above all, to promote order in the general series spectra. In the earlier editions these, together with the hydrogen spectrum, received mention rather through incidental comparisons in the argument of the fourth chapter: now they have been set out in detail in Chapter VI. I attach particular importance to the introduction of the inner quantum numbers (Chap. VI, § 5), and to the systematic arrangement of the anomalous Zeeman effects (Chap. VI, § 7). The regularities that here obtain throughout are primarily of an empirical nature, but their integral character demands from the outset that they be clothed in the language of quanta. This mode of explanation, just like the regularities themselves, is fully established and is unique. Even at the present early stage it has shown itself in many respects to be fruitful and suggestive. Doubts can arise only with respect to the interpretation in terms of the models. This interpretation has been attempted in Chapter VI on the basis of Paschen's thesis that the term-multiplicities arise from an intra-atomic magnetic field. "The Law of Displacement" and "The Law of Exchange" or "Cross Law" (*these terms are used synonymously in the English text*) have been carried further in the new account (§ 6) than before. The explanation of the various series terms by means of the intra-atomic electric field (§ 2), of course, constitutes as before the foundation of the theory.

The band-spectra, too, which before were sketched only in the notes, are now treated, with due regard to their importance, in Chapter VII. Following on them are the continuous emission and absorption spectra (Chap. VII, § 7).

Fortunately the systematic structure of Röntgen spectra has recently been investigated both experimentally and theoretically so far that the possible energy levels and the rules of selection that govern them have been made quite clear. Various gaps and errors in the second edition have been removed. Here, too, the

account is developed along quantum lines, but it is essentially empirical and culminates in an attempt to sketch a complete table of all Röntgen terms (Chap. VIII, § 6) which would in a certain sense represent the consummation of practical Röntgen spectroscopy. As before, the general and the more simple questions are treated first in the third chapter, and the finer questions in §§ 5 and 6 of the eighth chapter. For the present, however, the interpretation of the Röntgen spectra on the basis of models has been left out almost entirely. Whatever the further researches of Bohr may reveal to us concerning the shell structure of the atom, I feel certain that nothing will be changed in the laws of Röntgen spectra here described.

The last chapter of the previous edition, "Wellentheorie und Quantentheorie," has now become the fifth chapter. This was done to make the rules of selection and polarisation available for the sequel, and in order to allow the use of the normal Zeeman effect of the Balmer lines as a model for the anomalous Zeeman effects of the doublet- and triplet-systems. The fine structure and its relativistic basis, which was formerly treated in Chapter V, has now been placed at the conclusion of the book to crown the whole.

Will the view-point of the classical wave theory adopted in Chapter V and the idea of the continuous spherical wave stand the test of time? It is possible that we are even now passing through a critical period in the history of the wave theory. Yet in this as in other scientific revolutions we shall certainly take much of the older view over into the new one.

The following changes of detail deserve special mention. In order not to introduce the quantum theory too late the photoelectric effect and Einstein's law for its maximum velocities have been included in the first chapter on introductory facts. Through this the chief doctrine of the quantum theory is first introduced purely empirically. In Chapter II the former discussions of molecular models and atomic volumes have been thoroughly pared down. To balance this, § 6 on nuclear physics and §§ 5 and 7 on isotopes and sub-atomic chemistry have been added. In Chapter III the crystal structures so far known have been tabulated. The last section of Chapter IV, which deals with spatial quantising, also broaches the still rather involved question of the magneton. In Chapter V we have added § 7 on the adiabatic hypothesis, its historical origin and its manifold applications. As the most direct confirmation of the general

foundations of Bohr's theory we have appended in § 3 of Chapter VI the method of electronic collision so far as present results take us. The manuscript of this part was kindly checked by Messrs. J. Franck and H. Rau. In Chapter VIII, § 4, in dealing with the pictures of the fine structure of $\lambda = 4686$, I am happily able to make known for the first time a curve obtained by photometry which still further strengthens the final conclusions here to be drawn. The mathematical addenda have in part been reduced and in part been reinforced (contact transformations, principle of correspondence, adiabatic invariance of phase integrals).

The object of the book remains the same as before, namely, to give a comprehensive account, not however too difficult, which will also allow the non-academic reader to enter into the new physics of the atom and to grasp the meaning of spectral lines. Hence inordinately abstract mathematical developments had to be avoided or left to the notes at the end. An endeavour has been made to render the account throughout as vivid as possible. I hope that the rather more systematic points of view developed by Bohr in latter years (degenerate systems, etc.) have not been pushed too far into the background.

All things considered, I have a somewhat easier conscience in presenting this edition than when the first appeared. At that time much still seemed unripe and uncertain. Even now the subject matter is still in a state of violent ferment, but in the course of the years that have elapsed since the first edition much has already separated out as a definite residue. In particular, the way in which the facts of Röntgen spectra, of term multiplicities, of Zeeman effects, have been put together, half empirically and half by means of the quantum theory, will presumably remain unaffected by later developments. Bohr's recent far-reaching ideas will, indeed, add much that is new, but will not throw doubts on what now appears to be established.

In this edition, too, my collaborators have rendered friendly and valuable assistance, A. Kratzer in the band spectra and in reading the proof sheets generally, W. Pauli in the mathematical addenda and in reading a great part of the manuscript, G. Wentzel in the Röntgen spectra, and in making the index. How much of their own ideas has passed over into my account is not manifest in the text. My hearty thanks are due to them for their help as well as to the publishers.

A. SOMMERFELD

MUNICH

January, 1922

EXTRACT FROM THE PREFACE TO THE FIRST GERMAN EDITION

AFTER the discovery of spectral-analysis no one trained in physics could doubt that the problem of the atom would be solved when physicists had learned to understand the language of spectra. So manifold was the enormous amount of material that had been accumulated in sixty years of spectroscopic research that it seemed at first beyond the possibility of disentanglement. An almost greater enlightenment has resulted from the seven years of Röntgen spectroscopy, inasmuch as it has attacked the problem of the atom at its very root, and illuminates the interior. What we are now^{ya}days hearing of the language of spectra is a true "music of the spheres" within the atom, chords of integral relationships, an order and harmony that becomes ever more perfect in spite of the manifold variety. The theory of spectral lines will bear the name of Bohr for all time. But yet another name will be permanently associated with it, that of Planck. All integral laws of spectral lines and of atomic theory spring originally from the quantum theory. It is the mysterious *organon* on which Nature plays her music of the spectra, and according to the rhythm of which she regulates the structure of the atoms and nuclei.

September, 1919

TRANSLATOR'S NOTE

THE English rendering of Professor Sommerfeld's book departs from the German original of the third edition only in minor details. It was the expressed wish of the author that the translation should not be too literal, and that omissions and alterations were to be left to the discretion of the translator. It is hoped that the exercise of this privilege has caused no change in sense whilst conferring freedom of idiom. I wish to take this opportunity of thanking Professor Sommerfeld for his repeated assistance and courtesy. No physicist can fail to be grateful to him for embodying the most important of recent developments in spectroscopy and atomic physics in this easily intelligible form. He, himself, and his collaborators have contributed no mean share to these results, indeed more than is outwardly apparent in this book.

Since the appearance of the last German edition—on which this translation is modelled—new important facts have been discovered tending to confirm certain ideas put forward here. Chief among these is the confirmation of the magnetic moment of the silver atom by Gerlach and Stern (*Zeitschrift für Physik*). It is strong evidence in favour of the theory in Chap. IV, § 7 concerning directional quantizing in the magnetic field, and opens up new regions of research which may lead to undreamed-of consequences. From their measurements Gerlach and Stern have deduced that, within the limits of error of their experiments, the magnetic moment of the normal silver atom in the gaseous state is one Bohr magneton (see page 249). In a recent issue of the *Zeitschrift für Physik* Einstein and Ehrenfest have discussed the important question as to how the magnetic atoms of silver can alter their directions at all under the influence of a magnetic field. Difficulties appear to arise akin to that of the "time of accumulation" of energy quanta for Röntgen rays (see page 44).

The experiment itself consisted in sending a stream of silver atoms in a high vacuum (10^{-4} to 10^{-5} mm. of Hg) very closely past

the edge of the wedge-shaped pole of an electro-magnet, that is, the silver atoms were made to pass through a very strong heterogeneous magnetic field. They were finally deposited as a thin invisible layer on a glass plate. This layer was developed photographically, and it was then found that the silver atoms were separated into two discrete rays, showing that some of the atoms had been attracted towards the pole and others repelled from it.

Another new result is the proof of the existence of N-radiation (see Coster, *Phil. Mag.*). Then there is the discovery of Hafnium (Atomic Number 72).

It is perhaps not inappropriate to add a few words about the English equivalents of certain German terms. In cases where a suitable English expression has not readily suggested itself, I have considered it advisable to quote the German original (both in the text and in the index). It was felt that this would be of service to those who wish to pursue the subject further in original papers. In doubtful or difficult cases I have conferred with other physicists and have adopted whatever was favoured by the consensus of opinion. Only in two instances have expressions been used synonymously and indiscriminately: (1) the Law of Exchange = the Cross Law (*Wechselsatz*), page 379 *et seq.*; (2) the zero line = the null line (*Null-linie*), page 419. It is hoped that confusion will be averted by mentioning them here specifically.

Much help in reading and correcting the proofs and in offering fruitful suggestions was rendered, above all, by Mr. H. O. Newbould, B.A. (Scholar of Balliol College), also by Mr. H. F. Biggs, M.A. (Trinity College), and Mr. V. A. Bailey, M.A., D.Phil. (Queen's College), to whom I here wish to tender warm thanks. No effort has been spared to make the text accurate, and it is hoped that there will at least be no errors such as would make the reading irksome.

HENRY L. BROSE

CHRIST CHURCH, OXFORD

March 25th, 1923

CONTENTS

	PAGE
PREFACE TO THE THIRD GERMAN EDITION	v
EXTRACT FROM PREFACE TO THE FIRST GERMAN EDITION	viii
TRANSLATOR'S NOTE	ix

CHAPTER I

INTRODUCTORY FACTS	1-55
§ 1. Retrospect of the Development of Electrodynamics	1
§ 2. The Atomicity of Electricity. Ions and Electrons	3
§ 3. Cathode Rays and Canal Rays	8
§ 4. α - and β -rays	15
§ 5. Röntgen Rays and γ -rays	23
§ 6. Photo-electric Effect and its Converse. Glimpses of the Quantum Hypothesis	35
§ 7. Radio-activity	45

CHAPTER II

THE NATURAL SYSTEM OF ELEMENTS	56-109
§ 1. Small and Great Periods. Atomic Weights and Atomic Numbers	56
§ 2. Nuclear Charge and Atomic Number. The Atom as a Planetary System	62
§ 3. The Simplest Examples of Atomic Models	66
§ 4. Auxiliary Mathematical Reflections. Molecular Models	73
§ 5. The Laws of Radioactive Displacement and the Theory of Isotopes	79
§ 6. Observations on Nuclear Physics	89
§ 7. Peripheral and Central Properties of the Atom. Visible and Röntgen Spectra. Configurations of the Inert Gases	98

CHAPTER III

RÖNTGEN OR X-RAY SPECTRA	110-177
§ 1. Laue's Discovery	110
§ 2. Results of Crystal Analysis	121
§ 3. Methods of Measuring Wave-lengths	127
§ 4. Survey of the K-, L-, and M-series and the Corresponding Limits of Excitation	140
§ 5. The K-series. Its Bearing on the Periodic System of Elements	147
§ 6. The L-series and the M-series. Doublet Relationships	158
§ 7. Excitation and Absorption Limits. Regularities of the Absorption Co-efficients	177

CHAPTER IV

	PAGE
HYDROGEN SPECTRUM	193-252
§ 1. Introduction to the Quantum Theory. Oscillator and Rotator	193
§ 2. Empirical Data about the Spectra of Hydrogen. The Principle of Combination	202
§ 3. Bohr's Theory of the Balmer Series	211
§ 4. Relative Motion of the Nucleus	218
§ 5. The $K\alpha$ -line of the Röntgen Spectra. The Model of the He-nucleus	225
§ 6. Elliptic Orbits in the Case of Hydrogen	232
§ 7. Quantising of the Spatial Position of Kepler Orbits. Theory of the Magnetron	242

CHAPTER V

WAVE THEORY AND QUANTUM THEORY	253-313
§ 1. The Spherical Wave and its Propagation. Conservation of Energy and Momentum	253
§ 2. The Principle of Selection and the Rule of Polarisation	264
§ 3. Emission in a Field of Force. The Principle of Correspondence	270
§ 4. The Orbits of Hydrogen in the Stark effect	276
§ 5. The Resolution of the Balmer Lines in the Stark Effect	285
§ 6. The Zeeman Effect	294
§ 7. The Adiabatic Hypothesis	304

CHAPTER VI

SERIES SPECTRA IN GENERAL	314-412
§ 1. Empirical Data of the Scheme of Series	314
§ 2. Quantum Theory of the Series Scheme. The Principle of Selection for the Azimuthal Quantum	325
§ 3. Testing the Series Scheme by the Method of Electronic Impact	337
§ 4. Continuous Transition from the Röntgen Series to the Visible Spectra	353
§ 5. The Permanency of the Multiplicities. Inner Quantum Numbers	358
§ 6. Spectroscopic Law of Displacement and Law of Exchange	372
§ 7. The Anomalous Zeeman Effect	384
Addendum on Doublets and Triplets	406

CHAPTER VII

BAND SPECTRA	413-451
§ 1. Historical and Empirical Preliminaries. Uniform View of Deslandres and Balmer Terms	413
§ 2. The Infra-red Absorption Bands. Rotation and Rotation-vibration Spectra	425
§ 3. Visible Bands. Meaning of the Head of the Band	425
§ 4. Law of the Edge of the Band. Band Systems	433
§ 5. Many Lines Spectrum	437
§ 6. Gyroscopic Motion of Molecules, Zeeman Effect of Band-spectra	441
§ 7. Continuous Spectra	447

CHAPTER VIII

	PAGE
THEORY OF THE FINE-STRUCTURE	452-531
§ 1. Preliminaries concerning the Theory of Relativity. Variability of Mass and Inertia of Energy	452
§ 2. Relativistic Kepler Motion	467
§ 3. General Inferences. Fine-Structure and the Relativity Correction	475
§ 4. Comparison with Experiment	481
§ 5. Regular and Irregular Doublets of the Röntgen Spectra	496
§ 6. General System of Röntgen Spectra	512
§ 7. Universal Spectroscopic Units. Spectroscopic Confirmation of the Theory of Relativity	525
 MATHEMATICAL NOTES AND ADDENDA	 532-617
1. Radiation of Energy according to Classical Electrodynamics	532
2. Scattering produced by Bound Electrons	533
3. Tables of the Crystal Structures Hitherto Investigated	537
4. Proof of the Invariance of Hamilton's Equations for Arbitrary Changes of Co-ordinates. Contact Transformations	541
5. Concerning the Ratio of the Kinetic to the Potential Energy in the Coulomb Field	547
6. Some Examples of Integration by Complex Variables	548
7. Hamilton's Partial Differential Equation and the Separation of Variables. The Moduli of Periodicity of the Function of Action as a whole Multiple of Planck's Quantum of Action	555
8. Quantising of Elliptic Motion by the Method of Separation of Variables	569
9. The Spherical Wave and its Moment of Momentum	572
10. Bohr's Principle of Correspondence	577
11. The Stark Effect treated according to the Hamilton-Jacobi Method	587
12. The Adiabatic Invariance of Phase Integrals	594
13. Concerning the Spectra of Atoms not of the Hydrogen Type. Effect of the Supplementary Atomic Field	496
14. The Original Bohr Models of He, H ₂ , and H ₂ ⁺ and their Ionisation Potentials	601
15. Hamilton's Theory in the Principle of Relativity	606
16. Quantising of Relativistic Elliptic Motion by the Method of Separation of Variables	608
17. Quantising of the Non-Harmonic Oscillator during Simultaneous Rotation	611
INDEX	617

ATOMIC STRUCTURE AND SPECTRAL LINES

CHAPTER I

INTRODUCTORY FACTS

§ 1. Retrospect of the Development of Electrodynamics

IN the first half of the nineteenth century Electrodynamics consisted of a series of disconnected elementary laws formed analogously to Newton's Laws of Gravitation; they asserted the existence of direct action at a distance, which, starting from the seat of an electric charge or of magnetism and leaping over the intervening space was supposed to act at the seat of a second electric or magnetic charge.

Opposed to this there arose in the second half of the nineteenth century a view which followed the course of the continuously extended electromagnetic field from point to point and moment to moment; it was called the "Field Theory" in contradistinction to the "Theory of Action at a Distance." It was propounded by Faraday, worked out by Maxwell, and completed by Heinrich Hertz. According to this view the electromagnetic field is represented by the course, in space and time, of the electric and magnetic lines of force. Maxwell's equations teach us how electric and magnetic lines of force are linked with one another, how magnetic changes at any point of the field call up electrical forces, and how electric currents are surrounded by magnetic forces. The intervening medium, even if non-conducting, is supposed to have a certain transparency (permeability) and receptivity (dielectric capacity) towards magnetic and electric lines of force; hence it acts at every point of space on the distribution of the electromagnetic field according to its constitution at each point.

The greatest triumph of this view occurred when Hertz succeeded in connecting *light*, the phenomenon of physical nature with which we are most familiar, with *electromagnetism*, which was at that time the most perplexing phenomenon. After Maxwell had already surmised that light was an alternating electromagnetic field (he succeeded in calculating the velocity of light from purely electrical measurements made by Kohl-

rausch), Hertz produced his "rays of electric force," which, just like light, are reflected, refracted, and brought to a focus by appropriate mirrors, and which are propagated in space with the velocity of light. The electric waves produced by Hertz had a wave-length of several metres. From them an almost unbroken chain of phenomena leads by way of heat rays and infra-red rays to the true light rays, whose wave-lengths are no more than fractions of μ . The greatest link in this chain came later as a direct result of Hertz's experiments, namely the waves of wireless telegraphy, whose wave-lengths have to be reckoned in kilometres. (Nauen sends out waves having a wave-length of 12 kilometres, or $7\frac{1}{2}$ miles); the smallest and most delicate link is added at the other end of the chain, as we shall see, in the form of Röntgen rays, and the still shorter γ -rays which are of a similar nature.

Hertz died on 1st Jan., 1894, at the age of thirty-seven years. It would be natural to conclude that the later years of his short life and the work of his followers were occupied with an elaboration of his wave experiments and of his theory of electromagnetic fields. But the last experimental work of Hertz, "Concerning the Passage of Cathode Rays through Thin Metallic Layers," already pointed in a new direction.

The field theory had diverted attention from the origin of lines of force, and had chiefly served to illuminate their general course in a regular distribution of the field. The next question was to study the *singularities* of the field, the charges. The best conditions for doing so are offered by *cathode ray tubes*, which have a very high vacuum exceeding that of the so-called Geissler tubes (which were investigated by Plücker and Hittorf). Here we have electricity in a pure form, unadulterated by ordinary matter, and, in addition, moving in a straight line at an extremely high speed; cathode rays are corpuscular rays of negative electricity. It was not, of course, Hertz himself but his eminent pupil Lenard, who was instrumental in getting this view of cathode rays accepted; but Hertz had recognised the important value of the investigation of cathode rays for the future. Thus he had in this way helped personally in attracting workers from the field of physical knowledge just opened up by him towards pioneer work in a new field. In the sequel, the greatest interest became centred not on the propagation of the lines of force but on the charges, as the origin of these lines of force. The original theory of Maxwell which had been perfected by Hertz retained its significance for phenomena on a large scale, such as in electrotechnics and wireless telegraphy, and gave an easy means of determining the mean values of the electrical *phase quantities* (i.e. quantities that define the state of the field). But to render possible deeper research leading to a knowledge of elementary phenomena, a deepened view became necessary. Maxwell's *Electrodynamics* had to give way to Lorentz's *Dynamics of the Electron*; the theory of the continuous field became replaced by the discontinuous theory, that of the

atomicity of electricity. So the theory of action at a distance and the theory of action through fields was succeeded by the atomistic view of electromagnetism, the theory of electrons, which still holds to-day.

§ 2. The Atomicity of Electricity. Ions and Electrons

The theory of the atomicity of matter has existed ever since there was a science of chemistry; it is indispensable if the fundamental chemical law, that of multiple proportions, is to be intelligible. Nevertheless there has been no lack of opponents to atomicity. Goethe was one of them. It was repugnant to him to destroy the beautiful appearance of phenomena by dismembering it and adding human elements. The eminent scientist and philosopher Ernst Mach regarded the "Atomic Hypothesis" as merely transitory. He favoured the description of events in terms of continuously distributed matter and continuously acting laws. The last opponent of atomic theory was the keen-witted author of works on Energetics, Wilhelm Ostwald (who has now been converted to a belief in atoms). Objections to the theory have died into silence in the face of its sweeping successes in all branches of physical knowledge. The perfect explanation of the Brownian molecular movements which confirms by ocular demonstration in the case of fluids the branch of atomic hypothesis concerned with the theory of heat has contributed much to this acceptance. No less impressive is the confirmation of the atomic structure of solid bodies which was given by Laue's discovery and which will be discussed in Chapter III.

A necessary consequence of the atomicity of matter is the atomicity of electricity. This was stated simultaneously by Helmholtz and Stoney. Helmholtz remarked in his Faraday Lecture* of 1881, as a result of the laws of electrolysis which Faraday discovered and expressed in figures: "If we assume atoms of chemical elements, we cannot escape from drawing the further inference that electricity, too, positive as well as negative, is divided into definite elementary quanta that behave like atoms of electricity. Each ion,† as long as it is moving in the liquid, must remain associated with an electrical equivalent for each of its valency units."

Faraday's Law of Electrolysis actually states: *One and the same quantity of electricity, in discharging through various electrolytes, always sets free chemically equivalent quantities of the dissociated products.* In the case of univalent elements quantities are called chemically equivalent when they are in the ratio of their corresponding atomic weights, thus

1 grm. of H	35.5 grms. of Cl	107.9 grms. of Ag.
-------------	------------------	--------------------

* Helmholtz, *Vorträge und Reden*, Bd. 2, S. 272. The parallel work of Stoney bears the title: "Physical Units of Nature," and appeared in February, 1881, in the Proceedings of the Dublin Phil. Soc., and in Vol. 11 of Phil. Mag.

† As is well known, ions are the "wandering" constituents of electrolytes during electrolysis, the cation being the positively charged constituent which moves in the direction of the positive current, "downwards," so to speak, the anion being the negatively charged constituent which moves "upwards."

To dissociate these quantities, we always require, according to Faraday's Law, to make the same quantity of electricity pass through the electrolytes, namely the **electrochemical equivalent** :

$$F = 96,494 \text{ coulombs}^* = 9649.4 \text{ c.g.s. units.}$$

The constant ratios of weight 1 grm. H, 35.5 grms. Cl, and 107.9 grms. Ag become intelligible to us on the supposition of the atomicity of matter : 1 grm. of H is composed of just as many atoms of H as 35.5 grms. of Cl contains Cl atoms, or 107.9 grms. Ag contains Ag atoms. The equivalent charge F which is the same for each then becomes clear to us in the same way if we accept the atomicity of electricity : the equivalent charge F consists of just as many atoms of electricity or "elementary charges e ," as 1 grm. of H contains H atoms, or 35.5 grms. of Cl contain Cl atoms, and so forth. There is associated with every univalent atom (or more generally with every univalent ion) an elementary charge e , whilst there are associated with every divalent atom or ion two elementary charges, and so forth for atoms of higher valency. Just as the atomicity of matter is a direct outcome of fundamental chemical facts, so the atomicity of electricity is a direct outcome of fundamental electrochemical facts.

For the sake of brevity of expression we shall define two further terms. Following Ostwald we shall take a *mol* to be that number of grammes which is given by the number expressing the molecular weight of the substance in question. Thus 1 mol of $H_2O = 18$ grms., and 1 mol of $H_2 = 2$ grms. (In the case of monatomic elements we use the term *grammatom* instead of *mol*, e.g. 1 grammatom of H = 1 grm.) Furthermore, **Loschmidt's number L** denotes the number of molecules (or atoms, respectively) contained in one mol (or grammatom, respectively) of the substance in question. For example, in the case of water, or dissociated hydrogen, this number will be defined by the equations :

$$18 \text{ grms.} = Lm_{H_2O}, \text{ and } 1 \text{ grm.} = Lm_H \text{ respectively,}$$

whereby m_H denotes the mass, measured in grammes, of a hydrogen atom, and m_{H_2O} denotes the mass, similarly measured, of a molecule of water. With regard to this term it must be mentioned that recently, in German physical literature, the expression "Avogadro's number" is often used in place of "Loschmidt's number," for the reason that it also plays a part in Avogadro's law of gases. But as Loschmidt was the first to determine this number successfully (by means of the kinetic theory of gases), it seems more in keeping with the facts to associate his name with it. The fact that he made his calculations for the cubic centimetre and not for the mol, is a mere matter of form. If necessary the number L as defined above could be called "**Loschmidt's number per mol.**"

The equivalent charge F contains, as we saw, just as many elementary

* A coulomb = $\frac{1}{10}$ of the so-called absolute unit of charge, that is the unit of charge defined in the c.g.s. system and measured electromagnetically.

charges e as 1 grm. of hydrogen contains atoms of m_H , or, as we may now say, the electrochemical equivalent contains L elementary charges e . We therefore write :

$$9649\cdot4 \text{ c.g.s. units} = Le \qquad 1 \text{ grm.} = Lm_H$$

whence
$$\frac{e}{m_H} = 9649\cdot4 \frac{\text{c.g.s. units}}{\text{grms.}} \qquad \frac{1 \text{ grm.}}{m_H} = L. \qquad (1)$$

The ratio of the charge to the mass is called the **specific charge** of the ion in question. In the case of the positive hydrogen ion, this specific charge is thus 9649·4, whereas for the divalent positive copper ion it is

$$\frac{2e}{m_{Cu}} = \frac{2 \cdot 9649\cdot4}{63\cdot6}$$

and for the univalent negative chlorine ion, it is

$$\frac{-e}{m_{Cl}} = -\frac{9649\cdot4}{35\cdot5} \text{ and so forth.}$$

Electrolysis shows, as Helmholtz pointed out, that positive as well as negative electricity is composed of elementary quanta $\pm e$. But there is a great difference between positive and negative electricity in a certain respect. We know positive electricity only as an ion, that is, associated indissolubly with ordinary matter: as we saw above, negative electricity also presents itself in electrolysis in the form of ions. But we also know the latter in its free state, dissociated from all ordinary matter, as abstract electricity, so to speak. This is an all-important result of the researches on cathode rays, to which we have already referred in the preceding paragraph, and to which we shall again refer in the next.

The special position occupied by negative electricity, its occurrence as pure atoms of electricity calls for a special name. Following the example of Stoney,* we shall call the negative atom of electricity **electron**.

In saying that the electron is not encumbered by ordinary matter, we do not imply that it is devoid of inertia. On the contrary, the mere presence of electric charges, or, generally, of energy of every kind, entails a certain mass effect. The mass which is associated with the electron in this way used to be called "electromagnetic" mass. This term is, however, as the newer developments of fundamental physical conceptions compel us to recognise, too narrow: not only electric charges produce a mass effect, but so does the cohesive energy (gravitational energy?) that keeps the charge together and prevents it, in a way as yet unknown to us, from exploding. Therefore we nowadays prefer to speak outright of the *electronic mass* m , and to regard it as a fact presented by our experiments with cathode rays.

A great gap divides the electronic mass, as regards its magnitude, from the ordinary masses of atoms and ions. The electronic mass m is

* Cf. Trans. Dublin Phil. Soc., Bd. 4, 1891. In the mathematical development of the theory of electrons by H. A. Lorentz (*An Attempt at a Theory of Electrical and Optical Phenomena in Moving Bodies*, Leiden, 1895) the word electron does not occur: Lorentz retains the word ion in this essay.

about 1800 times as small as the mass m_H of the lightest atom. Accordingly, the *specific charge of the electron*, the ratio of the elementary charge e to the electronic mass m , is in the same proportion greater than the specific charge of the hydrogen atom. The most exact value* of this ratio at present known, is

$$\frac{e}{m} = 1.769 \cdot 10^7 \quad . \quad . \quad . \quad (2)$$

But it is not the researches on cathode rays that have led to a knowledge of this value of $\frac{e}{m}$. A more accurate value of the ratio was derived from optical experiments, measurements of spectral lines, to which we shall return in Chapter IV, and of spectral lines separated by magnetic fields, to which we shall return in Chapter V. (The value given above is taken from spectroscopic measurements made by Paschen.†) The general course of the refraction of light in passing through transparent bodies (solids and gases), as calculated on Drude's Theory of Dispersion, gives us values of $\frac{e}{m}$ of the same order of magnitude. But in the conduction of currents along metals, we see electrons at work, as also in radioactive processes, in the production of Röntgen rays (X-rays), in the photo-electric effect, and so forth. From this we conclude: *the electron is a universal element of structure of all matter.* * Whether it is flowing along slowly in an electric current, or hastening through space at an extremely high rate as a cathode ray, whether it is emitted in radioactive disruption or in a photo-electric process, whether it is vibrating in our lamps (or, as we should nowadays prefer to express it, "jumping" in our lamps), whether it effects the course of light in telescopes, it is always the same physical unit, proving its identity by exhibiting the same charge and the same mass,‡ in particular by keeping the ratio of charge to mass constant.

If we now wish to form a picture of the electron in accordance with the foregoing statements, only scant material offers itself. An electron is, like every negative charge, essentially nothing more than a place at which the electric lines of force from all directions end. In the case of an

* In electromagnetic c.g.s. units. The power of 10 that is added denotes, as we know, by how many places the decimal point is to be shifted to the right; in the case of a negative index the decimal point is to be shifted by so many places to the left, as is indicated by the index number. This method of representation is to be recommended not only for its brevity, but also because, without it, we should be compelled to add after the number given four zeros which would not be founded on experience and which would violate the physicist's respect for truth.

† In general, it must be remarked that in the following pages the data of experiments will be given to just that degree of accuracy which is known to be justified. We do this for the purpose of keeping before the notice of the reader that even in the boldest speculations of modern theory, we are concerned with things that have an exact numerical counterpart in experience.

‡ Cf. I. Flamm, *Physikal. Zeitschr.*, **19**, 518 (1917).

§ The "same mass" is more correctly expressed by the "same statical mass," i.e. mass which is not moving with respect to the system of reference, cf. § 4, equation (2) of this chapter.

electron at rest, these lines of forces are straight lines that come in uniformly from all directions. But the same picture holds, according to the ideas of the theory of relativity, for an electron moving in any way whatsoever, as long as the picture of the lines of force is regarded as being conceived by an observer moving with the electron, that is if the lines of force are drawn in a space that participates in the motion of the electron. In other cases, when the electron moves with regard to the observer who is mapping out its field, the electric lines of force would still, indeed, be straight lines, but would become compressed towards the central plane which is perpendicular to the direction of motion, and, moreover, would be accompanied by magnetic lines of force.

From the point of view of our present ideas, it is better to refrain from endeavouring to give the electron a definite volume or size. This could be calculated only on the assumption that the whole mass effect is electro-

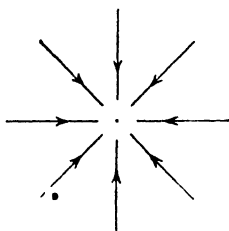

FIG. 1A.

Electron.

$$\frac{e}{m} = 1.769 \cdot 10^7$$

$$e = 1.591 \cdot 10^{-20}$$

$$m = 0.899 \cdot 10^{-27}$$

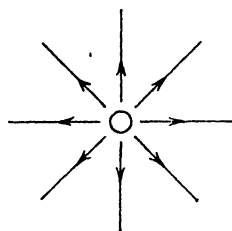

FIG. 1B.

H-ion.

$$\frac{e}{m_H} = 96,494$$

$$e = 1.591 \cdot 10^{-20}$$

$$m_H = 1.649 \cdot 10^{-24}$$

$$L = \frac{1}{m_H} = 0.606 \cdot 10^{24}$$

magnetic in origin, and this assumption is, on account of the necessity for a cohesive energy (*vide* above), not justified. Moreover, we should be compelled in this case to make the arbitrary assumption that the electronic charge e occupies uniformly, either the volume or the surface of a sphere, for which there is no support in our experience. Nevertheless it is worthy of remark that in whatever way the detailed calculation is carried out we arrive at a sub-atomic value for the extent of the electron, an extent that is about 10^{-5} times as small as that of an ordinary atom.

The picture of an ion, for example, of the positive hydrogen ion, shows itself to be quite similar to that of the electron. As the lines of force start out from positive charges, they are to be furnished with arrows in the reverse direction to that for electrons; they are likewise rectilinear and uniformly distributed, if we here also suppose the observer to be at rest relatively to the ion. In contradistinction to the electron, shown in

Fig. 1A, the ion has, in general, a definite size, which is indicated in Fig. 1B. It happens that in the special case of the hydrogen ion, which is reduced to a mere nucleus (cf. Chap. II, § 3, No. 2), this size becomes illusory and, as in the case of the electron, assumes sub-atomic dimensions. The subscription of Fig. 1B refers to the hydrogen ion, but the figure itself has been drawn for any arbitrary spatially extended ion.

We have furnished our drawings with the characteristic values of the *specific charge*, as well as with the values of the *absolute charge* and the *mass*, so that they may serve as a reference note for the properties of the electron and of the ion. The origin of these numbers will be explained in part in the next paragraph.

§ 3. Cathode Rays and Canal Rays

The cathode of a vacuum tube is, according to the terminology that we explained in connexion with the word cation (cf. note on p. 3), the electrode to which the positive current flows, that is from which the negative current emerges. The fact that the cathode rays start from the cathode is already an indication that we are dealing with a flow of negative electricity. In the case of a high vacuum and a sufficiently high potential difference, this flow does not follow the form of the tube as in the case of the ordinary Geissler tubes, but spreads out rectilinearly from the cathode along the normals of the latter. Assuming the results of the decades of research* on cathode rays ranging from Hittorf to J. J. Thomson and Lenard, we shall speak of **cathode ray particles**, or rather, of **cathode ray electrons**. These electrons owe their velocity to the potential gradient at the cathode, so that the kinetic energy of the electron is equal to the work that the drop in potential does on the electron. Inasmuch as the kinetic energy is proportional to the electronic mass m , and the amount of work is proportional to the electronic charge e , we see that the velocity v of the electron is determined by its specific charge $\frac{e}{m}$ and by the voltage drop of the vacuum tube † V (volts multiplied by 10^6). The formula (which is nothing more than the law of the conservation of energy) is:

$$\frac{mv^2}{2} = eV, \quad v = \sqrt{\frac{2e}{m}V} \quad . \quad . \quad . \quad . \quad . \quad (1)$$

It is justifiable to say that the experiments with cathode rays are the simplest and most perfect confirmations of the principles of mechanics, more perfect than experiments with projected stones, and simpler than the motion of heavenly bodies. As we shall later have to apply the principles of mechanics frequently to the electronic motions in the atom,

* Details may be found in the excellent account by Kaufmann, Müller-Pouillet, Vol. 4, fifth book; a still more elaborate description is contained in the work of Lenard: *Quantitative über Kathodenstrahlen aller Geschwindigkeiten*, Heidelberg, Verlag Winter, 1918.

† The potential difference expressed in volts is converted into absolute electromagnetic c.g.s. units by multiplying by 10^6 .

we shall do well to convince ourselves, at this stage, of their validity in the cathode ray tube.

A good apparatus for our experiments is a Wehnelt tube (potential difference 110 volts, pressure about 0.1 mm. of mercury, cathode furnished with a spot of CaO, which, at a red heat, assists the emission of electrons). The phenomena of illumination in the tube, which are very striking, are due only indirectly, as we must mention at the outset, to the cathode ray electrons, and arise from the impact of the latter with

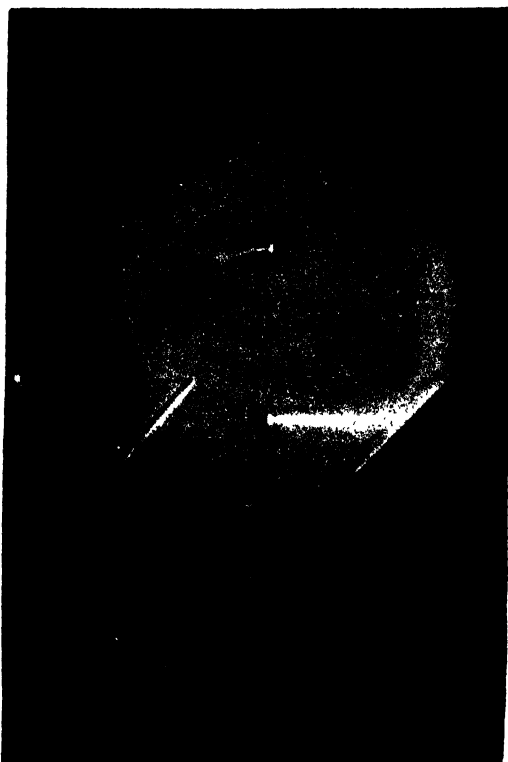

FIG. 2A.

the remains of the gaseous content. By means of our tube we now confirm the following mechanical laws:—

1. *In the absence of external forces a body describes a straight line with constant velocity.* Corresponding to this law we see in Fig. 2A how the beam of cathode rays are emitted perpendicularly to the cathode K, and disappear into the anti-cathode AK. (Above the beam of cathode rays we see in this and in the following picture a bright image that is formed by reflection from the glass sides.) The anti-cathode is not in general connected with the source of voltage, and is to be distinguished

from the anode A. The fact that the beam of cathode rays diverges (becomes "scattered") as its distance from its source increases, is due to the influence of the remaining gas molecules on the paths of the electrons. The high value of the velocities of the electrons compared with the relatively small voltage of 110 volts is worthy of notice. From (1) it follows, that, in round figures,

$$v = 6 \cdot 10^8 \text{ cms. per sec.} = \frac{1}{50}c,$$

where $c = 3 \cdot 10^{10}$ cms. per sec. = velocity of light.



FIG. 2B.

2. *Under the influence of a centripetal force, that is, one which is everywhere perpendicular to the orbit, a body describes a circle at a constant rate.* The centripetal force is equal to the inertial resistance which is directed perpendicularly to the orbit and is called the "centrifugal force." We shall produce the centripetal force that is necessary for the experiment by a magnetic field, which arises from an ordinary bar-magnet MM. A magnetic field acts on moving charges ("current-elements") with a force that is perpendicular to the magnetic lines of force and to

the direction of motion. In Fig. 2b. the magnetic lines of force run from the front to the back, so that the centripetal force in question lies in the plane of the page. We see the beam of cathode rays become curved under its influence into a circle (or into a spiral, if the initial direction of the cathode rays and the direction of the magnetic field are not exactly perpendicular to one another: in our case we should then get a curve of variable curvature because the magnetic field is not homogeneous). It is pretty to see how the circle increases or decreases as the magnet moves away or approaches. Expressing this in a formula we find that if H denotes the intensity of the magnetic field, ρ the radius of the circle (more generally the radius of curvature of the curve), then

$$evH = m \frac{v^2}{\rho} \quad (2)$$

On the left is the centripetal force due to the magnetic field, on the right is the inertial resistance of the electron, or, expressed shortly, the centrifugal force. In this case, too, as we see, the ratio $\frac{e}{m}$ occurs as a determining factor. From (2) we get

$$v = \frac{e}{m} \rho H \quad (2a)$$

3. In a homogeneous and parallel field of force, as, for example, is represented by gravity on the earth's surface, a body describes a parabola, the form of which depends on the value g of the acceleration in falling, or, more generally, on the acceleration in the field of force in question. In our tube we generate the necessary field of force as an electric field by charging the anti-cathode negatively, as by connecting it with the cathode by hand. The field that results in this way is confined to the neighbourhood of the anti-cathode, and is tolerably homogeneous there. The cathode rays that previously disappeared at the anti-cathode are now bent backwards into a parabolic shape (cf. Fig. 2c, p. 12). (Above the anti-cathode there is a kind of dark space that somewhat disturbs the regularity of the parabola.) If F is the field intensity, then we get for the accelerative force that acts in this case:

$$g = \frac{e}{m} F \quad (3)$$

These and similar experiments clearly lead to determinations of $\frac{e}{m}$ by various methods. We may, for example, combine (1) and (2a), eliminate v , and determinate $\frac{e}{m}$ from the three measurable quantities ρ , H , V . This value, when it was first discovered, led to the discovery of the electron. For as it was almost 2000 times greater than the value of $\frac{e}{m}$ that was derived from experiments in electrolysis, it pointed to the

existence of a micro-mass which is almost 2000 times smaller than the mass of the hydrogen atom.

Certain results connected with the absorption of cathode rays are of particular interest for questions of atomic structure. Lenard was the first to lead the cathode rays out of their capacity in the tube by allowing them to enter into the air through extremely thin metal folia (so-called Lenard windows). Although they here also soon came to a dead stop owing to repeated obstruction by air molecules, nevertheless they clearly

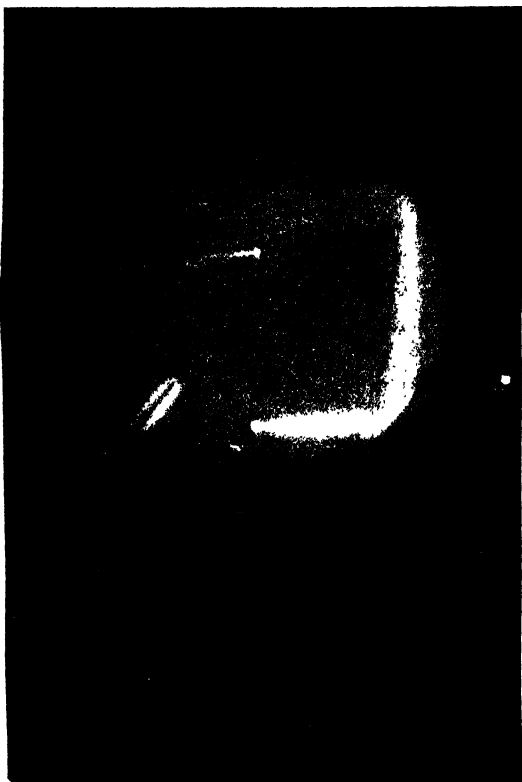

FIG. 2c.

exhibited their corpuscular existence independently of the producing tube. Systematic experiments on absorption now showed that the absorption, i.e. the arresting (bringing to a stop) of an electron depends solely on the mass of the atoms of the absorbing substance, not on its physical state or its chemical composition. On the other hand, according to the kinetic theory the mean sum (average) of the atoms would be the decisive factor in the collisions and hence in the stoppage of a cathode ray. The comparison of the actual circumstances with those of the kinetic theory led Lenard to form the following picture of the structure of matter: Only a

vanishingly small fraction of the space apparently occupied by matter is really impenetrable (at least for rapid cathode rays); the electrons can fly without obstruction through the whole intervening space. The impenetrable centres are called **dynamides** by Lenard.* They are regarded as electric fields of force and exercise an attraction on the electrons, which are no longer effective for great velocities at a moderate distance from the centres of force. In the case of small velocities the range of action of the attraction increases up to the extent of the range of action given by the kinetic theory of gases. Lenard has to set the number of dynamides per atom proportional to the mass of the atom, that is to the atomic weight, to get the law of absorption for rapid cathode rays.

The whole method of representation developed by Lenard as early as 1903 coincides strikingly with the nuclear theory that Rutherford built up in 1913 from a totally different set of facts (*vide* Chap. II, § 2). We need only replace **dynamide** by **nucleus**, and **number of dynamides per atom** by **nuclear charge**, to translate Lenard's results into the language now in use. In addition, the sub-atomic size of the dynamides, as calculated by Lenard, is in approximate agreement with the order of magnitude of the nuclei, as deduced by Rutherford. Proportionality of the number of dynamides with the mass of the atom then denotes proportionality of the nuclear charge with the atomic weight (cf. Chap. II, § 2). A difference which is essential for the fruitfulness of the picture consists in the circumstance that, in the case of an element whose atomic number is Z (and which, in some cases, then has the atomic weight $2Z$), Lenard assumes Z individual dynamides, generally separated in space, whereas Rutherford assumes a single nucleus carrying a charge Z . For the rest, our comparison of these two sets of ideas merely confirms the observation, which often forces itself on us, that important scientific facts, when once ripe for discovery, present themselves to various investigators independently.

The antithesis **electron** and **positive ion** is analogous to that of **cathode rays** and **canal rays**.† The canal rays also obtain their velocity as a result of the potential drop at the cathode, but they run backwards in the direction opposite to that of the cathode rays (Goldstein, 1886). They are thus oppositely charged to the particles of the cathode rays; they are accordingly **positive rays**. To enable them to pursue their paths backwards from the cathode, the latter has to be pierced with holes ("canals"). The canal rays, like the cathode rays, follow rectilinear paths. They are likewise deflected by magnetic or electric fields, but in a direction opposite to that of cathode rays, corresponding to their reversed charge. Besides this, the deflection is considerably less than in the case of cathode rays. For if these deflection experiments are used to determine the specific

* Ann. d. Physik., **12**, 714 (1903).

† A comprehensive account is to be found in *Handbuch der Radiologie*, Bd. 4. Leipzig, 1917, W. Wien.

charge of the particles in the canal rays, we find a value having the order of magnitude of the electrochemical equivalent, and indeed we get the exact value $\frac{e}{m_H}$, as given in § 2, Fig. 1B, in the case of canal rays of hydrogen, that is when the tube is filled with hydrogen; we get a value 200 times as small in the case of canal rays of mercury (atomic weight of mercury = 200), that is when the tube contains mercury, and so forth. It may be mentioned that in the latter case, we also get multiples of this value, a fact that points to a multiple charge of the mercury atom (to the number of eight elementary quanta, according to J. J. Thomson). In the former case we observe in addition to the full equivalent charge, also half of this quantity, and this points to the formation of positively charged hydrogen molecules (mol-ions as contrasted with atom-ions).

Altogether, the conditions in the case of canal rays are not so typically simple and easy to grasp as in the case of cathode rays. This is due to the frequent transference of charges among the ions of the cathode rays (W. Wien). They become neutralised after a short distance by taking up electrons, and become positively charged again through the loss of one or more electrons in subsequent collisions (sometimes they become negatively charged owing to the absorption of electrons). For this reason the phenomena in the case of canal rays are, on the other hand, much more manifold and instructive, inasmuch as the canal rays, as ions, possess the power of emitting light of their own (J. Stark). The luminescent phenomena of canal rays (cf. Chap. V, the Stark effect) have furnished modern physics with invaluable material in just the province that concerns us here.

The opposite character possessed by ions and electrons manifests itself, too, in the velocities of canal rays and cathode rays. The relatively large mass of the ions of canal rays, for a constant voltage of the tube, assumes a much smaller velocity than the small mass of the electron of cathode rays. The corresponding velocities are theoretically in the ratio of the square roots of the masses of the electrons and the ions, since equation (1) remains valid for velocities that are imparted to the ions of canal rays. In the case of cathode rays we get for a tension of 30,000 volts, for example, a velocity of 10^{10} cms. per sec. = $\frac{c}{3}$; in the case of canal rays we scarcely get beyond $2 \cdot 10^8$ cms. per sec. = $\frac{c}{150}$.

So far, in the case of both the ion and the electron, we have been concerned only with the measurement of the *specific* charge. On the other hand, we also mentioned the *absolute* value of the elementary charge e at the end of the preceding section as being an equal, invariable, and universal quantity for ions and electrons. We must therefore complete our account by stating how the elementary charge itself may be determined. It is obvious that if we know the absolute charge then (by

comparing it with the specific charge) we can also find the electronic mass m and the absolute mass of the hydrogen atom m_H , as well as the Loschmidt number $\frac{1}{m_H}$ and the mass of all other atoms. The values of m , m_H , and L found in this way are also noted at the end of the preceding section.

There are many ways of deriving the elementary charge e . From our discussions about the theory of spectral lines we shall get a spectroscopic determination of e which promises to give us the most accurate values (cf. the final paragraph of Chap. VIII.). At present, however, the surest road seems to be that which has been followed with particular success by Millikan.*

A macro-ion, that is a charged particle of matter composed of many atoms, preferably a drop of oil, on account of its shape, is kept suspended by balancing an electric field against its weight, or it is allowed to drop slowly by altering the field or its own charge. By means of radiation from radioactive bodies or Röntgen rays (X-rays) the charge may be varied to the extent of one or several units of charge e . By noting the times taken to fall in the case of one and the same particle, we get the data necessary for calculating both the size of the particle and also its charge. The result of measurements repeated by Millikan over a span of several years is:

$$e = (4.774 \pm .004)10^{-10} \quad (4)$$

In (4) the elementary charge is given in so-called **electrostatic units** (E.S.U.). We may express its value in **electromagnetic units** (E.M.U.), which are usual in the case of the specific charge, by dividing the above value by $c = 3 \cdot 10^{10}$:

$$e = (1.591 \pm .001)10^{-20} \text{ E.M.U.} \quad (5)$$

This was the value noted at the end of the preceding section.

§ 4. α - and β -rays

Not only are canal rays and cathode rays produced artificially, but they also occur naturally, being emitted during the disintegration of radioactive elements.† **The positively charged α -rays correspond to the canal rays, and the negatively charged β -rays correspond to the cathode rays.** These natural corpuscular rays are much more violent and tempestuous than those produced artificially. In this way they testify directly to the immense stores of energy available in the interior of the atom, with which even those released in our modern evacuated bulbs are ridiculous in comparison. As the fields of force in the interior of the atom are

* Phil. Mag. (6), **34**, 1 (1917).

† For general information on radioactive radiations *vide* St. Meyer and E. V. Schweidler, *Radioaktivität*, Leipzig, 1916, and E. Rutherford, *Radioactive Substances and their Radiations*, Camb. Univ. Press.

later to be subjected to a special investigation, it will be good to get at this early stage an idea of their elemental power.

The velocity of the α -rays of radium C amounts to $2 \cdot 10^9$ cms. per sec. It is about ten times as great as the velocity attained by canal rays. It follows from equation (1) of the preceding section that the energy that is necessary to produce this ten times greater velocity is 100 times greater than, or, if we take into account the carriers of the α -rays (*vide* below), even 400 times greater than the canal rays of hydrogen. Hence, whereas we work a canal ray tube by means of a potential difference of 30,000 volts, i.e. 30 kilo-volts (KV), we should require a voltage of about 12,000 KV to produce the energy of α -rays. A comparison of cathode rays with β -rays gives similar results. We may produce artificial cathode rays having a velocity ranging from $\frac{c}{3}$ to $\frac{c}{2}$, whereas natural β -rays are known whose velocities differ by only 1 per cent and less from c . Since, as we shall see later, the velocity of light, c , represents an unsurpassable limit for every velocity of material particles, a limit which may be approximated to only when the energy applied is increased without limits, we see that to a velocity which approaches to within 1 per cent of c , there corresponds a voltage of the same order of magnitude as was just given for α -rays.

For cases in which the velocities of the β -rays approximate so closely to the velocity of light, it is clearly convenient to express these velocities by giving their ratio to c instead of giving their absolute values v in cms. per second. This ratio, which is always a proper fraction, is usually denoted by the letter β , thus :

$$\beta = \frac{v}{c}, \quad 0 < \beta < 1. \quad . \quad . \quad . \quad . \quad (1)$$

From experiments on the deflection of α - and β -rays the specific charge has been found to be *half* the value of the *equivalent charge* $\frac{e}{m_H}$ in the case of α -rays, and considerably greater in the case of β -rays, namely, of the *order of magnitude* of the *specific charge of the electron*, $\frac{e}{m}$.

The latter discovery confirms our above statement that β -rays are particularly rapid cathode rays. But the former discovery set physicists before a triple choice from which experiments on deflection offered an escape only after the effect of each single α -particle could be successfully demonstrated, that is, after a means of counting α -particles had been discovered. A decision had to be pronounced in favour of one of the three following possibilities, all of which were compatible with the value of the specific charge of the α -rays particle :—

1. $\frac{e}{m_{H_2}}$, i.e. the α -particles, are singly charged hydrogen molecules (that is molecules, each of which carry a unit charge).

2. $\frac{e}{m_x}$, i.e. the α -particles are singly charged atoms of an element x , hitherto unknown, and having the atomic weight 2.

3. $\frac{2e}{m_{\text{He}}}$, i.e. the α -particles are doubly charged helium atoms (atomic weight of He is 4.00).

The experimental researches mentioned have demonstrated the truth of the third suggestion. This means that the *radioactive elements are able to produce from within themselves doubly charged positive helium atoms*. By demonstrating the presence of the He spectrum physicists succeeded in confirming this conclusion by direct observation.

In consequence of this we now understand the difference between the general properties of α - and β -rays. On account of their great mass ($4m_{\text{H}}$), the α -rays pursue their paths with great persistency. They shatter

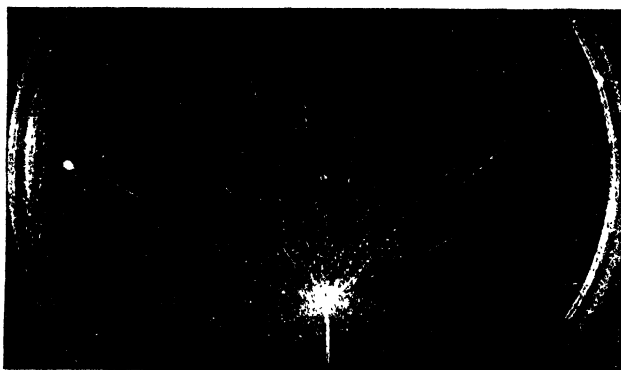

FIG. 3A.

the obstacles which they encounter in the form of air molecules. The latter thereby become ionised, that is, they become split up into positively and negatively charged ions. And, indeed, the α -rays in their passage through atmospheric air form several thousand ions in every millimeter of their paths. The β -rays, on the other hand, being of extremely small mass are much more easily deflected from their paths. They exert a comparatively small influence on the air molecules with which they come into contact and form ions only now and then (5 or 10 per mm. according to their velocities).

These properties of α - and β -rays were exhibited in a striking way by some beautiful photographs of C. T. R. Wilson,* which have often been reproduced and which we must consider here also. His method consisted in bringing a radio-active substance into the vicinity of a vessel

* C. T. R. Wilson, Phil. Trans., **193**, p. 289, 1899.

which contained super-saturated water vapour; by this means, α - and β -rays were introduced into the closed chamber. The gaseous ions which are formed by these rays serve, just as in the case of the gaseous ions or particles of dust that are instrumental in the production of rain in the atmosphere, as nuclei about which the super-saturated water vapour may condense when the moist air is suddenly allowed to expand. The drops of water which thus form and collect rapidly are what we see on the photographs.

The path of an α -particle is characterised on the plates as a dense, apparently continuous, mark (indicative of strong ionisation), but, in



FIG. 3B.

reality, it consists of individual drops of condensed vapour. In general, its course is a straight line (due to its great mass). Fig. 3A shows a sheaf of α -rays which start out from the end of a wire which has been made radioactive, like the divergent rays of the sun at dawn. Fig. 3B was produced by α -rays that originate at a point of convergence outside the picture. Several of them show, towards the ends of their paths, where their speeds have already been weakened, pronounced hooks (sudden bends). We here call particular attention to this apparently subsidiary phenomenon for the reason that, as we shall see later (Chap. II, § 2), far-reaching consequences arise through it.

On the other hand, the path of a β -particle is deflected much more

often and much more easily (on account of its small mass) and is punctuated only rarely with drops of water vapour, as is manifest on the photographic negative (this indicates feeble ionisation). In Fig. 4 we see in particular, besides diffusely scattered drops of water, the paths of two such β -rays, of which one is strongly curved several times. In Fig. 5 we see, in addition to the thick (highly magnified) path of an α -particle (with a pronounced hook towards the end), several traces of the paths of β -rays.

To shed further light on the nature of β -rays we shall enlist the aid of another scientific document, one of the deflection-pictures obtained in the famous experiments on β -rays by Kaufmann*: it is here reproduced

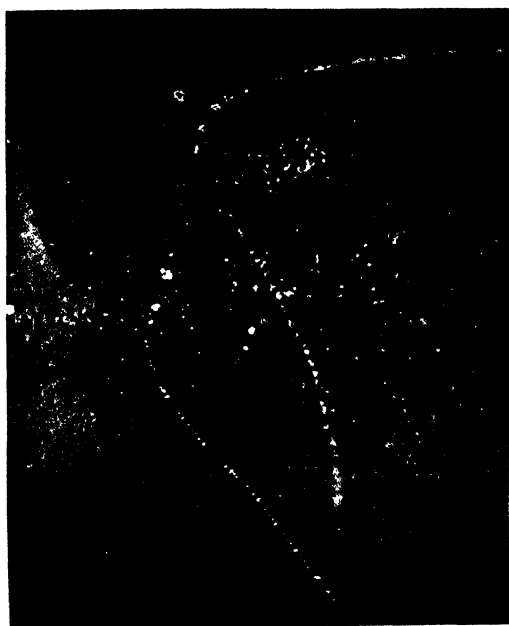

FIG. 4.

about six times magnified. The sheaf of β -rays emitted by a radium salt and singled out by means of a series of fine apertures is exposed to the simultaneous action of a magnetic and an electric field. The lines of force of both fields are parallel to one another and to the photographic plate. The electric lines of force divert the β -ray electrons from their ordinary paths, to the right in our figure, to the left when the field is reversed by commutation. The magnetic lines of force cause a deflection at right angles to themselves, in Fig. 6 this is upwards. Both deflections depend on the velocity. The greater the velocity, the smaller the

* W. Kaufmann performed these experiments in the period 1901-1906: a résumé of them is given in *Ann. d. Phys.*, **19**, 487 (1906).

deflection. For each velocity of the β -electron, therefore, a different "deflected point" or, if we commute, too, each time, a different deflected point-pair will be recorded on the plate to the right and left.

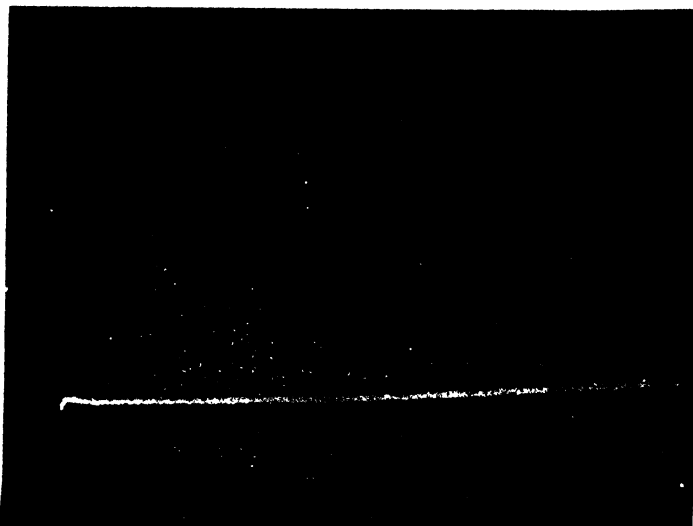

FIG. 5.

Now since this beam of β -rays may contain all possible velocities reaching almost to the velocity of light, a continuous section of line marked by the points of deflection will be produced, or, rather, two branches of a curve are produced that converge towards the point of departure on the path of the undeflected beam. The latter path is also recorded on the plate thanks to the photographic action of the undeflected γ -rays (cf. § 5). From formulæ (2) and (3) of the preceding section we can easily verify that the branches of the curve would have to be two parabolas that touch, having a common vertical tangent at the last undeflected point if the electronic mass m were constant, that is, the same for all velocities. As an experimental fact the two branches do not touch (cf. the tangents t and t' which have been sketched into Fig. 6), but run into one another, inclined at a certain angle. From this it is to be inferred that *the electronic mass depends on the velocity and that it increases beyond all limits as it (the velocity of the electron) approaches that of light.*

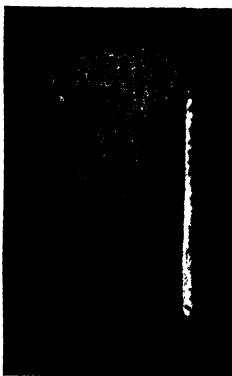

FIG. 6.

This result excited great astonishment, as is easy to understand, for

it shattered the time-honoured dogma that mass is constant. But Kaufmann wished to read still more from his negatives. He wished to learn from them the law according to which the mass of the electron alters with the velocity. In this connexion there were two opposing theories which led to different forms for this law, namely, the older theory of the absolute ether (the original theory of Lorentz, elaborated in particular by Abraham for the questions here under consideration), and its younger rival, the theory of the relativity of motions (founded by Einstein). The latter theory gives rise to a particularly simple form of the law governing the change of mass with motion, namely to the formula :

$$m = \frac{m_0}{\sqrt{1 - \beta^2}} \quad . \quad . \quad . \quad . \quad . \quad . \quad (2)$$

In it β is the velocity, as explained in equation (1), expressed in terms of the velocity of light c ; m_0 is the mass at rest or "statical mass," corresponding to the velocity $\beta = 0$; m is the mass of the moving electron. The theory of relativity asserts that this is true not only for the electronic mass m , but also for any arbitrary mass of matter. This means that every arbitrary mass must increase as β increases and must become infinitely great when $\beta = 1$. From this the thesis, stated right at the beginning of this section, that the velocity of light represents for all velocities of material bodies a limit that cannot be exceeded, i.e. that the velocity of light can only be approached asymptotically but never passed, would already follow as a natural consequence.

It can easily be grasped from this that the deflection experiments of β -rays were regarded for a long time as the *experimentum crucis* which was to decide for or against the doctrine of the relativity of motions, and that they were thus to determine our fundamental views of space, time, motion, and the ether. As far as Kaufmann's experiments are concerned, it has been proved that they were not sufficiently accurate to give a decisive answer. Later experiments have established more and more definitely the correctness of the relativistic formula for mass (2). In our spectroscopic discussions later we shall likewise arrive at a confirmation of this formula by a method that far exceeds all others in accuracy (see the final paragraph of Chap. VIII).

We might well close our brief survey of corpuscular rays here, were it not that we have still to discuss several general questions dealing with the nature of electricity. Are we to regard electricity as unitary or dualistic? Is it made of matter or of energy, of substance or of force?

The question as to whether it is of one kind or of two kinds has been proposed long ago particularly with reference to Voltaic currents. Does only one type of electricity or do two contrary types, in opposite directions, move along a conducting wire? The battle resolved into one of words, as no decisive experiments on this point could be suggested. Even nowadays we have really advanced no further in this question as

far as *current* electricity is concerned, but by adducing other evidence about electrons we are justified in asserting that what flows in a conducting wire can only be negative electricity; and that even a current of electricity in metals is a current of electrons. In this field our view is thus unitary.

In the realm of atomic physics, however, we are inclined to take the dualistic view. A positive charge signifies more than the absence of a negative charge. *Positive electricity is always associated with ordinary matter.* We have thus to deal with two types of electricity that differ not only in sign but also in nature. As representatives of negative and positive electricity we have the electron and the positively charged H-atom.

There is no reason why we should not claim these two representatives as *negative* and *positive electrons*, respectively. Just as all negative electricity consists of the ordinary negative electrons, so all matter, according to the old hypothesis of Prout and the newest results of Aston (cf. § 5 of the next chapter), very probably resolves into positive hydrogen ions. Hence, as the fundamental elementary constituent of matter and of positive electricity, the positive hydrogen ion deserves the name of positive electron. In using the term "positive and negative electron," we have already adopted the dualistic view, even if not the dualism of two elements of a like type, but of two that differ radically in respect of mass.

In the following respect, too, there is a difference of type between negative and positive electricity. We can picture an atom (or a body) as highly charged negatively as we like, that is, we can add to it any number of negative electrons. But we can increase the positive charge only to a certain maximum amount so long as we do not considerably alter the mass. For we can abstract from the atom only just as many electrons as it possesses from the outset. In the case of the He-atom, as we shall see, this maximum limit is already reached when it has two positive charges, in the case of the H-ion when it has only one. A further increase in the positive charge could be effected only by simultaneously increasing the mass, that is, by adding positively charged matter.

This really furnishes us at the same time with the answer to the second question, as to whether we are to imagine electricity as a substance. To us nowadays negative electricity certainly denotes a substance. It is one of two universal and fundamental substances of which positively charged matter is the other; both are equally entitled to being called such. If we regard an unalterable constitution as the characteristic of substance, then the charge (positive as well as negative) is more truly a substance than matter (electronic mass or ordinary mass). As a matter of fact we saw, as an inference from Kaufmann's experiments, that every mass varies according to its state of motion at the time under consideration

(more correctly, according to the state of motion relative to the observer in question). In the case of the theory of relativity, too, no change in the electric charge enters into question. *In consequence of its absolute immutability the charge, in contradistinction to the mass, proves itself to be true substance. The charge and the mass are hereby indissolubly associated with one another, the negative charge with the electronic mass, the positive charge with the hydrogen mass.*

§ 5. Röntgen Rays and γ -rays

Röntgen's discovery was made in the year 1895. He was working with a highly evacuated cathode ray tube and observed the presence of penetrating rays that started out from the part of the tube at which the cathode rays struck the glass wall. These rays propagate themselves in all directions in straight lines from their source and are not deflected by a magnet.* For this reason Röntgen himself had looked on his "X-rays" as wave-radiation. At first it remained undetermined whether they were longitudinal or transverse in character. As we know, improvements in the construction of X-ray tubes have brought it about that the X-rays are no longer produced at the glass wall but at an *anti-cathode* placed in the path of the beam of cathode rays: it is found preferable to make the anti-cathode of a metal with a high melting-point (e.g. platinum, tungsten, molybdenum, etc.). The cathode rays that strike it are thus brought to rest. By giving the cathode the shape of a soup-plate the focal point of the beam of cathode rays is made as small as possible.

The question whether the rays were longitudinal or transverse was decided by Barkla ten years after Röntgen's discovery. Even in the original researches of Röntgen it had been ascertained that all bodies, especially metals, on which X-rays impinge, serve as sources of new ("secondary") X-rays. In the same way *secondary* X-rays generate *tertiary* X-rays. Now, Barkla discovered that *primary* X-rays are *partially polarised*, *secondary* X-rays are *wholly polarised* in certain directions. He succeeded in proving this with the help of tertiary X-rays, that is with the help of the secondary rays produced by secondary rays. For reasons to be given later, Barkla used as the generator of secondary rays not metals, but substances that are composed only of light atoms (charcoal, paraffin, paper). We must parenthetically mention another product of the action of impinging X-rays, namely *secondary cathode rays* which were discovered in 1900 by Dorn. They occur simultaneously with secondary X-rays and are similar in velocity to the primary cathode rays that produced these X-rays.

Polarisation signifies that a ray favours a certain plane passing through it more than the one perpendicular to this plane. In the case

* The older developments of the work with which we are concerned in this section have been collected together by R. Pohl, *Die Physik der Röntgenstrahlen*, Braunschweig, 1912 (Sammlung Wissenschaft).

of longitudinal vibrations, that is, vibrations that occur in the direction of the ray, there is symmetry about the ray and no such preference can be imagined. Longitudinal radiation must therefore be unpolarised. In the case of transversal vibrations, however, a favoured plane (including, of course, all parallel planes) is determined by the direction of vibration and the direction of the ray. It is only when no direction of vibration is favoured that a ray composed of transverse vibrations can be unpolarised. We here interpret the direction of vibration not as being the direction of a motion or of matter, but only of the electric force which participates in the wave-radiation. With this electric force is associated a perpendicular magnetic force.

Let us first discuss in a general sense the production of electromagnetic waves. In doing so, we shall adopt the standpoint of classical electrodynamics and of the theory of electrons. The fact that the newest developments have led to the partial rejection of this view is not to disturb us for the present.

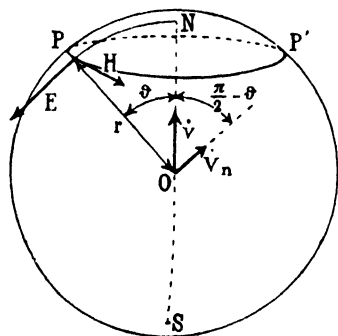

FIG. 7.

A charge e which moves non-uniformly radiates energy, for it generates an electromagnetic field which propagates itself with the velocity of light. (A charge moving with uniform motion, such as a cathode ray particle, carries its electromagnetic field along with it, and hence does not radiate.) Consequently the intensity of the radiated field is in general proportional to the acceleration $\dot{\mathbf{v}}$ of the charge; in particular, in the direction

$r = OP$ (cf. Fig. 7, in which O is the position of the charge, P that of the observer, briefly called the initial point) it is proportional to the component of acceleration $\dot{\mathbf{v}}_n$, which lies in the plane through $\dot{\mathbf{v}}$ and r , and which is perpendicular to r . We describe a sphere through P , about O as centre, with the radius r , and mark as its north and south poles N and S , the two points at which the acceleration vector, when produced, meets the sphere. Let us fix the position of P on the sphere by means of the angle θ (complement of the geographical latitude). Then

$$\dot{\mathbf{v}}_n = \dot{v} \sin \theta.$$

The electric force lies in the meridian plane ONP , the magnetic force is the tangent to the small circle PP' . These forces are of equal magnitude

* Following Newton, we indicate the increase with respect to time by a dot thus :

$$\dot{\mathbf{v}} = \frac{d\mathbf{v}}{dt};$$

in the case here considered in which the velocity is supposed to have a constant direction, \dot{v} denotes the value of $\dot{\mathbf{v}}$ when the direction is disregarded.

if, as is natural, we measure \mathbf{E} in the electric ("electrostatic") system and \mathbf{H} in the magnetic ("electromagnetic") system, namely

$$\mathbf{E} = \mathbf{H} = \frac{e\dot{\mathbf{v}}}{c^2 r} \quad (1)$$

(the charge e is measured in electrostatic units, just like \mathbf{E}). The dependence of these quantities on r , as expressed in the equation, may easily be seen *a priori*. During the process of emission of radiation, the same flux of energy passes through each spherical shell. Since the surface of each increases proportionately to r^2 , the specific flux of energy \mathbf{S} , the so-called Poynting vector, must decrease as r^2 increases. But, if

we disregard the factor $\frac{1}{4\pi}$ which depends on the system of measurement, \mathbf{S} is equal to the product of \mathbf{E} and \mathbf{H} (at least, when \mathbf{E} and \mathbf{H} are perpendicular to one another; cf. Note 1 at the end of the book), thus in our case:

$$\mathbf{S} = \frac{c}{4\pi} \mathbf{E}\mathbf{H} = \frac{e^2 \dot{\mathbf{v}}^2}{4\pi c^3 r^2} = \frac{e^2 \dot{v}^2}{4\pi c^3 r^2} \cdot \sin^2 \theta \quad (2)$$

From this (by integrating over the surface of the sphere, cf. also Note 1) we get for the total flux of energy

$$\mathbf{S} = \frac{2}{3} \frac{e^2 \dot{v}^2}{c^3} \quad (3)$$

Our representation (1) of the field is a necessary consequence of the established principles of electrodynamics. It shows the *transversal character of the field* (\mathbf{E} and \mathbf{H} are perpendicular to r , that is, to the direction of the ray \mathbf{S}). In addition, it shows that *in the longitudinal direction, that is, in the direction of the acceleration $\dot{\mathbf{v}}$, the emission of radiation becomes zero* ($\sin \theta = 0$). This fact is used practically in wireless telegraphy: in the direction of the antenna (that is, of the alternating current, corresponding to our $\dot{\mathbf{v}}$) the emission is zero: it is a maximum in the direction at right angles to the antenna. The position of \mathbf{H} , too, corresponds to the well-known circumstances that attend the passage of alternating currents through a wire: the lines of magnetic force are circles around the wire (corresponding to our small circle PP' in Fig. 7).

After these preliminary remarks, we have now to imagine secondary X-rays to be produced as follows: Every body, whether solid, liquid, or gaseous, is built up of electrons and positively charged matter. In Fig. 8, let 1 be the direction of the primary beam from R (Röntgen, or X-ray, bulb) to K (the scattering body). We assume that at the outset the primary ray is unpolarised and that it consists of transversal vibrations (the possibility of longitudinal vibrations is already excluded owing to the mere fact of polarisation). Let us then resolve the electric force, as shown at the bottom of the figure on the left, along the two perpendicular directions 2 and 3, which are perpendicular to 1; we get two equally intense component forces along 2 and 3. When the component 3 has arrived at the surface of K, it sets the electrons in motion along the direction 3.

These electrons thus become the source of a new radiation. This radiation gives us, as we saw, no intensity along 3, but maximum radiation in the direction 2. In the same way the component force 2 sets the electrons of K into motion. The radiation thus produced gives no intensity in the direction (2), but maximum radiation in the direction 3. From this it follows that the secondary radiations s , which are propagated in the direction 2, are derived from electronic vibrations in the direction 3 and likewise vibrate in this direction. *They are thus completely polarised.* The same is true of the secondary rays that are propagated in the direction of 3 and which vibrate in the direction 2; and it is true of all secondary rays that are propagated at right angles to the primary direction 1. (The secondary rays that are obliquely inclined to 1 are partially polarised.)

But how can we recognise the complete polarisation of the secondary ray s in the absence of a Nicol for X-rays? By repeating the process,

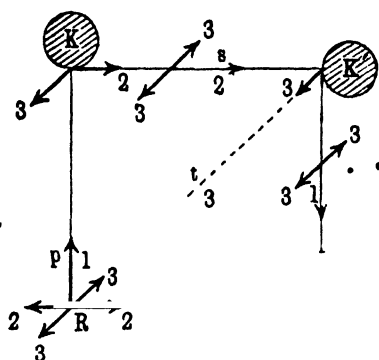

FIG. 8.

we place a second scattering body K' in the path of the secondary ray s and measure the tertiary X-rays. These are produced by electronic vibrations that take place exclusively in the direction 3. They emit maximum radiation in the direction K'1, and none at all in the direction K'3. *The perpendicular set of lines pst in the directions 1, 2, 3 proves by the vanishing of the intensity of the tertiary rays K'3 both the complete polarisation of the secondary rays and the transversal nature of the primary rays.*

In Barkla's experiments the scattering bodies K and K' consisted of charcoal. The intensity of the tertiary rays was measured electroscopically by their ionising action on the air space of a condenser (ionisation chamber), which is very sensitive towards X-rays and which had already been perfected and used in the original experiments of Röntgen. Provided that the primary radiation was fully unpolarised, K2 and K3 would have to show the same degree of intensity under similar conditions of measurement. In reality, as Barkla, and later Bassler, found, the secondary rays already show differences of intensity with direction. *They thus indicate a partial polarisation of the primary radiation.*

The latter circumstance leads us still more deeply into the process of production of the primary X-rays. In Fig. 9 let K be the plate-shaped cathode and AA the anti-cathode. When the cathode rays strike the anti-cathode, they are arrested; their average direction of retardation is represented in the figure by the arrow \dot{v} . This change of velocity causes

radiation to be produced, which is the shorter in wave-length and the more intense, the greater the change of velocity. *This radiation is to be regarded as the reason (or better, a reason) for the occurrence of X-rays.* The resultant field is described by the earlier Fig. 7. In it the direction SN is now represented by the direction KA of the cathode rays. The electric force lies in the meridian planes, that is, now, in the plane KAR through the cathode ray and the X-ray. The process of formation of X-rays thus points directly at a favoured plane for the electric force. *The observations (of Barkla and others) have confirmed this position of the plane of polarisation.*

According to our argument we should actually expect a complete polarisation of the primary X-rays. What is the cause of the incomplete character of the polarisation? A reason that immediately suggests itself is that there are changes in the direction of the impinging cathode rays before and after they have been stopped by the material of the anti-cathode. Through them the direction of the arrow \dot{v} and hence also of the direction of polarisation becomes blurred. But there is a still deeper reason.

Barkla has discovered that every material substance when bombarded with cathode rays emits a radiation characteristic of the substance (called "**characteristic radiation,**" *Eigenstrahlung*). Whereas we may compare the radiation considered just above ("**impulse radiation,**" *Bremsstrahlung*) with the forced vibrations

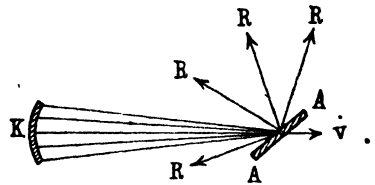

FIG. 9.

that occur in mechanics—as a necessary consequence of the sudden stoppage—this characteristic vibration corresponds to the free or natural vibrations of mechanics. Through the agency of the cathode rays the electrons of the material of the anti-cathode are thrown out of their positions of rest (or out of their stable orbits) and tend to return to these. In doing so they emit the frequencies natural to, or characteristic of, the material of which the anti-cathode is composed. This circumstance gives the process a resemblance to optical fluorescence, in which, likewise, a frequency of vibration occurs which is characteristic of the fluorescent material but differs from the frequency of the incident radiation. The phenomenon occurs freely, being excited by the cathode ray but, especially in regard to direction, is not subject to conditions. *Thus the characteristic radiation is unpolarised, and the total radiation (impulse radiation + characteristic radiation) is only partially polarised.*

As a result of the polarisation experiments above discussed, there is no doubt that the radiation of X-rays is of the transverse wave type.

Nowadays we speak of Röntgen light or X-ray light and distinguish it from visible light only by its greater hardness (penetrative power).

This general character of Röntgen light is shown very strikingly in a photograph, here reproduced in Fig. 10, by C. T. R. Wilson (cf. § 4, p. 17). In contrast with the former photographs (Figs. 3, 4, 5), we see here no rectilinear nor curved corpuscular paths, but a thick bundle of rays that traverse the space of the condensation chamber in a horizontal direction. This bundle of rays is made visible to us photographically not *directly* but *indirectly* by the secondary cathode rays (see p. 23), that is, by the electrons that have been set free from air molecules and molecules of water vapour by the X-rays, and which fly out laterally and irregularly, and cause the water vapour to condense.

The *hardness* of Röntgen light represents what we usually call colour in the case of ordinary light. Great hardness denotes great frequency of vibration or small wave-length. Moderate hardness or greater "softness" denotes smaller frequency and greater wave-length. This terminology introduces no difficulty in the case of characteristic radiation. We called



FIG. 10.

this free vibration and are tempted to ascribe to it a period (or a series of periods) of vibration characteristic of the material of the anti-cathode. This we may actually do, for experimental researches have fully confirmed this conclusion. The characteristic radiation is not only "characteristic" but also "homogeneous." It consists of a few sharply defined kinds of vibration, each of which corresponds to a homogeneous monochromatic type of light. When we have become acquainted with the spectral resolution of X-rays (Chap. III), we shall see that the characteristic radiation assumes the form of a line-spectrum.

To supplement our earlier statements we must add the following: As the atomic weight of the body emitting the characteristic radiation increases, so does the hardness and the intensity of the characteristic radiation. Anti-cathodes of heavy metals produce copious and hard characteristic vibrations, whereas charcoal, paraffin, etc., produce only scant characteristic vibration, which is soft, being absorbed after traversing only a few centimetres of ordinary atmospheric air, and which, therefore,

hardly deserves the name of Röntgen radiation. Hence we understand why Barkla, to prevent being disturbed by the characteristic radiation of the scattering body, had to use bodies of small atomic weight for his experiments on polarisation. On the other hand, makers of X-ray appliances had to resort to heavy metals for their anti-cathodes so as to make use of characteristic vibration as well as the impulse radiation.

Our explanation of hardness does not seem to be so readily applicable to the case of impulse radiation. The process of impulse radiation is a single event; that is to say, it is non-periodic. Consequently the conceptions of period of oscillation and wave-length here seem out of place. During the time required in coming to a stop (length of impulse) a single shock emanates from the anti-cathode; an electromagnetic impulse is emitted out into space; its field is contained between two spheres that are described about the place at which the retardation or stoppage is effected, and that widen out with the speed of light. The distance between the two spherical shells gives the measure of the width of the zone of disturbance; it is the "width of the impulse." Thus instead of wave-length, width of impulse was formerly the term used in speaking of Röntgen radiation.

Now, it is a simple mathematical truth that a single unperiodic occurrence may be represented as composed of a number of purely periodic occurrences superposed on one another.* For example, the crack of a gun may be represented by a continuous series of musical tones, if these are chosen of the proper intensity and phase (Fourier's integral representation of an arbitrary function). The physical realisation of this mathematical mode of representation is called the *spectrum* of the occurrence in question. From the moment that the spectrum of such an event can be specified, the spectral picture will be preferred on account of its fixed quantitative character. This moment had arrived, in the case of X-rays, when Laue made his discovery. Since then, we speak of the spectrum, wave-length, and frequency of vibration in the case of impulse radiation too. Instead of *one* width of impulse we have then a *continuous series* of wave-lengths, to each of which there corresponds a purely periodic vibration of definite intensity. Accordingly the spectrum is not as in the case of the characteristic radiation a line-spectrum but a *continuous spectrum*. It resembles the spectrum of white light and is therefore occasionally called the *white Röntgen spectrum*. The difference between the white Röntgen spectrum and that of white light, for example, is only in the order of magnitude of the dominant region of wave-lengths, of the region of maximum intensity. The mean wave-length of this region is in the case of X-ray spectra 10,000 times smaller than in that of the solar spectrum.

As we saw, the hardness of the characteristic radiation depends on the atomic weight of the emissive material of the anti-cathode. On the other hand, the hardness of *impulse radiation depends essentially on the voltage of the X-ray bulb*, or on what is the same, according to equation

(1) of § 3, the velocity of the impinging cathode rays; as is well known, the hardness increases with the voltage of the bulb. In the language of spectra this means that the *region of wave-lengths of greatest intensity in the continuous spectrum shifts towards the smaller wave-lengths as the voltage increases*. We shall pursue this fundamental law further in the next paragraph. To do so, we must discard the view-point of classical electrodynamics here adopted, and must build up on the basis of the modern quantum theory.

For our special purpose—atomic structure and spectral lines—the characteristic radiation with its line-spectrum, which is characteristic of the emitting atom, will of course be more important than the impulse radiation with its continuous spectrum essentially conditioned by the voltage of the tube. But firstly we have yet to call attention to various observations about the latter that are intelligible on the basis of classical electrodynamics and mechanics.

We inquire into the total *scattered secondary radiation* that is emitted per unit of time by a body (radiator) struck by primary X-rays. The scattered secondary radiation, in contrast with the simultaneous secondary characteristic radiation of the radiator, has the same hardness, or in more precise terms, the same continuous spectrum as the primary radiation. Its intensity, calculated for a single emitting electron, is given by equation (3). We shall write it down here for the unit volume δ of the radiator and take n as the number of atoms per unit volume, Z the number of electrons per atom. (The radiator is assumed to be a chemical *element*; in the case of a compound the various atoms would have to be differentiated.) We then obtain from (3)

$$S = \frac{2}{3} \frac{c^2 \dot{\mathbf{v}}^2}{c^3} nZ \quad . \quad . \quad . \quad . \quad . \quad . \quad . \quad (4)$$

This implies the assumption that the quantities of energy emitted by the individual electrons of the atom become simply superposed, an assumption which no longer holds for white light (cf. Note 2) and which even in the case of excitation by X-rays is not true for all directions of the scattered radiation (cf. again Note 2).

The acceleration $\dot{\mathbf{v}}$ of the individual electron is closely connected with the electric intensity of field \mathbf{E}_p (of the primary X-ray which impinges on it) by the equation

$$m\dot{\mathbf{v}} = -e\mathbf{E}_p \quad . \quad . \quad . \quad . \quad . \quad . \quad . \quad (5)$$

In (5) we have assumed the electron to be free. If it is bound to a position of rest, the restoring force has to be added. In the case of sufficiently hard X-rays, we may discard this force; in the case of optical frequencies it must be taken into account (cf. Note 2). By inserting (5) into (4) we get

$$S = \frac{2}{3} \frac{e^4}{m^2 c^3} \mathbf{E}_p^2 nZ \quad . \quad . \quad . \quad . \quad . \quad . \quad . \quad (6)$$

Again, we determine the energy P of the primary radiation that falls per unit of time on the unit of area of the radiator and excites secondary radiations in it. We get (cf. eqn. (2), in which $\mathbf{H} = \mathbf{E} = \mathbf{E}_p$)

$$P = \frac{c}{4\pi} \mathbf{E}_p^2 \quad . \quad . \quad . \quad . \quad . \quad (7)$$

From (6) and (7) we get

$$\frac{S}{P} = \frac{8\pi}{3} \frac{e^4}{m^2 c}$$

The energy S is produced at the expense of the energy P and hence causes a decrease in the latter, an "absorption through scattering." The ratio $\frac{S}{P}$ is called the "absorption coefficient due to scattering" and is designated by s .

From it we pass on to the absorption coefficient of mass $\frac{s}{\rho}$ by dividing by the density ρ . Whereas s is a measure of the scattering per unit of volume, $\frac{s}{\rho}$ is a measure of the scattering per unit of mass. Now

$$\rho = nm_H M = n \frac{M}{L} \quad . \quad . \quad . \quad . \quad . \quad (9)$$

in which M is the atomic weight of hydrogen, $= 1$, and thus $m_H M$ is the mass of a single atom; and $nm_H M$ is the mass of the atoms contained in unit volume, i.e. it denotes the density ρ ; $L = \frac{1}{m_H}$ is (see p. 4) "Loschmidt's number per mol."

From (8) and (9) we get

$$\frac{s}{\rho} = \frac{8\pi}{3} \frac{e^4 L}{m^2 c^4} \frac{Z}{M} = K \cdot \frac{Z}{M} \quad . \quad . \quad . \quad . \quad (10)$$

The factor K is a universal quantity independent of the nature of the radiator. Its value may be calculated according to the data at the end of § 2 in Figs. 1A and 1B. In doing this, it must be observed that we have here reckoned e in electrostatic units, and hence according to the remark at the end of § 3 we must divide it by c to reduce it to electromagnetic units. We then obtain

$$\frac{e}{mc} = 1.77 \cdot 10^{-7}, \quad \frac{eL}{c} = 9.65 \cdot 10^3, \quad \frac{c}{c} = 1.59 \cdot 10^{-20}$$

hence

$$K = 0.40 \quad . \quad . \quad . \quad . \quad . \quad (11)$$

From this we can determine the ratio $\frac{Z}{M}$ from (10) if the absorption coefficient of mass is found by observation. Such observations have been made by Barkla (for air) and by Barkla and Sadler (for C, Al, Cu, Ag). In the case of air, C and Al, the value attained (in cms. and grms.) is

$$\frac{s}{\rho} = 0.2 \quad . \quad . \quad . \quad . \quad . \quad (12)$$

For Cu and Ag, greater values (0.4 and 0.5) were found, but in their cases we are no longer dealing with pure scattering, for secondary characteristic radiations occur, as well scattered secondary rays, and these increase the demand for primary radiation and hence increase the absorption coefficient of mass. Taking this into consideration we may say: *for small atomic weights measurements lead to the uniform value 0.2 for $\frac{\kappa}{\rho}$, whereas for greater atomic weights the values obtained do not contradict the assumption that the same value holds generally to a certain degree of approximation so long as we are concerned only with the absorption due to scattering.* Now, from (10), (11), and (12) the remarkable result follows

$$\frac{Z}{M} = \frac{0.2}{0.40} = \frac{1}{2} \quad \dots \quad (13)$$

The number of electrons per atom is half as great as the atomic weight (proved for atomic weights smaller than 27; extrapolated for higher atomic weights, and in their case, as we shall see later, this rule is only approximately true).

For the sake of completeness we must emphasise that the law contained in (12) is subject to a very noteworthy exception in the case of *extremely hard X-rays*. We get for them values of $\frac{\kappa}{\rho}$ that continuously and systematically fall below 0.2 as the wave-length decreases. For further details we refer to Note 2 and merely remark here that the occurrence of this exception for just the shortest wave-lengths is very surprising. In the case of long waves for which the distances of the electrons from one another in the atom compared with the wave-lengths can no longer be regarded as great, the vibrations emitted by the individual electrons would interfere with one another, analogously to what happens in optics, so that in their case we should be able to understand a departure from (12), since it takes no account of such an interference but assumes a simple superposition of energy. Nevertheless in the case of short wave-lengths this departure must be due to another reason. Presumably it hints again at the limits of validity of the classical theory and the necessity of supplementing it by the quantum theory.

From the secondary rays we return once more to the primary ray and inquire whether their mode of generation (sudden stoppage of cathode rays at the anti-cathode) can be proved in greater detail by observations. To answer this we must first generalise formulæ (1) a little. These formulæ related to the radiation that was emitted by a single electron that was subjected to an acceleration $\dot{\mathbf{v}}$, but that possesses no velocity comparable with c . They cannot, therefore, be applied to rather rapid cathode rays $\left(\beta = \frac{v}{c} = \frac{1}{3}(\text{say})\right)$ without some modification.

They must be replaced, if β is not very small, by (see Note 1)—

$$\mathbf{E} = \mathbf{H} = \frac{e\dot{\mathbf{v}}_n}{c^2 r (1 - \beta \cos \theta)^3} = \frac{e\dot{v}}{c^2 r} \frac{\sin \theta}{(1 - \beta \cos \theta)^3} \quad (14)$$

in which θ denotes, as in Fig. 7, the angle between the direction of the X-ray under consideration and the direction of $\dot{\mathbf{v}}$ (being the same as the direction of the generating cathode ray). In place of (2) we then get for the energy radiation \mathbf{S} at the angle θ and measured per unit of time and surface :

$$\mathbf{S} = \frac{e^2 \dot{v}^2}{4\pi c^3 r^2} \frac{\sin^2 \theta}{(1 - \beta \cos \theta)^6} \quad (15)$$

This is the radiation emitted during any arbitrary moment of the process of stopping: β denotes the velocity still left at this moment, divided by c . To arrive at the total radiation $\bar{\mathbf{S}}$ emitted during the whole process of stopping, we must sum all the amounts \mathbf{S} (i.e. integrate over the time). We get (cf. Note 1), if we keep \dot{v} constant,

$$\bar{\mathbf{S}} = \frac{e^2 \dot{v}}{16\pi c^2 r^2} \cdot \frac{\sin^2 \theta}{\cos \theta} \left(\frac{1}{(1 - \beta \cos \theta)^4} - 1 \right) \quad (16)$$

In contradistinction to (15) β here denotes the initial velocity of the cathode ray, which becomes reduced to zero through the stoppage. For values of β that are much less than 1 (slow cathode rays) we get from (16)

$$\bar{\mathbf{S}}_0 = \frac{e^2 \dot{v} \beta}{4\pi c^2 r^2} \sin^2 \theta \quad (17)$$

The result of this calculation is depicted in Fig. 11. The curve $\frac{1}{10}$ represents the emission of radiation for $\beta = \frac{1}{10} \ll 1^*$, according to equation (17), for every angle θ between 0° and 180° . It exhibits a maximum for $\theta = 90^\circ$, as we ascertained earlier in the case of scattered secondary radiation, and a symmetrical decrease on both sides of $\theta = 90^\circ$. Of course, the figure must be imagined three-dimensional by supposing it rotated about the direction of the cathode ray. The curve $\frac{1}{2}$ has been drawn for $\beta = \frac{1}{2}$. The maximum is here displaced in the direction of smaller θ 's, and is indicated by a small circle: it is still further displaced in the outermost curve which holds for $\beta = \frac{1}{3}$. For $\beta \cong 1 \dagger$ we should get a pear-shaped figure for the curve of emission, with a maximum near $\theta = 0$. For $\theta = 0^\circ$ itself, as for $\theta = 180^\circ$, the emitted radiation, on account of the factor $\sin^2 \theta$, is necessarily zero under all circumstances, as has already been mentioned above in the discussion on secondary radiation. Concerning the size relationships of the figure, it is to be remarked that all three curves have been drawn for the same v .

This progressive *advance of the maximum* was derived by the author theoretically as long ago as 1909 \ddagger and has been confirmed by observation

* \ll signifies considerably less than, \gg signifies considerably greater than.

$\dagger \sim$ signifies is of the order.

\ddagger Physik. Zeitschr., 10, 969 (1909).

several times, with the greatest accuracy in a work by W. Löbe.* In the experimental observations the differences of intensity are not so pronounced as in our figure, because in this case there is superposed on the impulse radiation the unpolarised radiation, particularly the characteristic radiation of the anti-cathode, which is equally intense in all directions. Besides the *differences of intensity* primary X-ray radiation exhibits *differences in hardness*. The hardness increases uniformly from $\theta = 180^\circ$ to $\theta = 0^\circ$ as we may prove by a simple geometrical consideration involving Doppler's Principle.† These differences in hardness have also been actually observed.

It is hoped that the latter reflections will help to give the reader a picture of how successful and how trustworthy in detail are the classical methods of calculating radiation. That, notwithstanding this, they have

yet to be refined by the introduction of the quantum theory is no longer open to doubt.

The radioactive γ -rays bear the same relation to X-rays as α - and β -rays bear to the canal and cathode rays. Like X-rays they are a wave radiation; likewise they cannot be deflected by electric or magnetic fields. We have already encountered them in Kaufmann's Fig. 6 of the previous paragraph (at the point of non-deflection on these). The γ -rays, too, may be resolved spectrally. The result has been a line-spectrum of γ -radiation

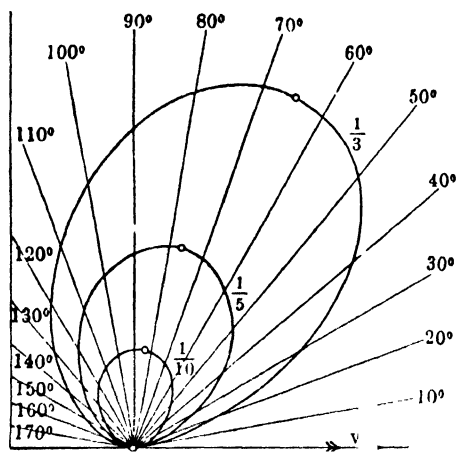

FIG. 11.

which links up continuously with the hardest characteristic X-rays and extends towards the region of decreasing wave-lengths to waves about twenty times smaller. It is possible that there exists considerably harder γ -rays than those hitherto known. In any case it may be stated that the difference in hardness between X-rays and γ -rays is by no means as great as that between visible light and X-rays (the ratio of the wave-lengths is in the latter case given by a factor of about 10^{-4}). Whether, in addition to the line-spectrum, there is also a *continuous background in the γ -spectrum* has not yet been decided. Experiments carried out by Edgar Meyer ‡ seem to favour of a one-sidedness in the emission of γ -rays, similar to that which occurs in the case of Röntgen rays, but, in conformity with

* Ann. d. Phys., **44**, 1033 (1914).

† Physik. Zeitschr., **10**, 969 (1909).

‡ Ann. d. Phys., **37**, 700 (1912); cf. also E. Buchwald, *idem*, **39**, 41 (1912).

the greater hardness, this characteristic is correspondingly more strongly pronounced. The γ -rays, too, produce scattered secondary radiation and secondary β -radiation. In radio-therapy, γ -radiation alone is effective: it is surmised that its effectiveness is due solely to the secondary β -radiation generated in the diseased tissues, which thereby causes their disintegration (cf. Fig. 10, in which the corresponding process is exhibited for the case of air that is traversed by X-rays). In particular, it is the γ -rays of RaC and MsTh2 (cf. Table 1 of § 7 in this chapter) that are applied in medical practice.

All things considered, there is no doubt about the similarity of nature between γ -rays and X-rays.

§ 6. The Photo-electric Effect and its Reversal. Glimpses of the Quantum Hypothesis

Just like the modern development of the doctrine of cathode rays (cf. § 2), so the knowledge of the photo-electric effect* is to be traced back to a paper by H. Hertz (*Concerning an Effect of Ultra-violet Light on Electric Discharge*, 1887). Following in Hertz's footsteps, Hallwachs showed that when a metal plate is exposed to short wave radiation, it becomes positively charged; and again, as in the case of cathode rays phenomena, it was Lenard† who recognised that the true cause of this whole category of phenomena was to be sought in the corpuscular negative rays, the photo-electric cathode rays. Their specific charge $\frac{e}{m}$ was found to be equal to that of ordinary cathode rays, but their velocity was found to be only a fraction of the latter. Whereas in the Wehnelt tube we met with particularly slow cathode rays excited by a voltage of 110 volts, the photo-electric cathode rays, when reduced in the same way to an imagined excitation voltage, correspond to only one or two volts (according to equation (1), p. 8). They thus have a velocity that is ten times smaller than the already "low" velocity (amounting to only six million cms. per second) in the Wehnelt tube (cf. p. 10).

The following discoveries of Lenard are of very great importance.‡

* For further details see Pohl and Pringsheim, *Die lichtelektrischen Erscheinungen*, Sammlung Vieweg, Nr. 1, Braunschweig, 1914. This also contains a description of the interesting "selective photo-electric effect" which originated in researches of Elster and Geitel and which was further investigated by Pohl and Pringsheim. They show that there is an increase in the number but not in the velocity of the escaping electrons when the plate is exposed to wave-lengths that lie in the neighbourhood of a certain favoured or resonance wave-length, especially when the plane of polarisation is perpendicular to the plane of incidence. In the text we restrict ourselves to the so-called "normal photo-electric effect," which is independent of the polarisation of the exciting light. An exhaustive discussion of the literature as far as 1912 is to be found in Hallwachs, "Handbuch der Radiologie," Bd. 3. See also Pringsheim, *Fluorescenz und Phosphorescenz im Lichte der neueren Atomtheorie*, Springer, Berlin, 1921.

† P. Lenard, *Erzeugung von Kathodenstrahlen durch ultraviolettes Licht*, Wiener Akademie, 108, 1649 (1899).

‡ P. Lenard, *Über die lichtelektrische Wirkung*, Ann. d. Phys., 8, 149 (1902).

The *intensity* of the exciting light has *no* influence on the *velocity* of the excited photo-electric cathode rays; the intensity determines only the *number* of electrons emitted, which is exactly proportional to the intensity. The velocity of the escaping electrons depends primarily on the *colour* of the exciting light. Ultra-violet light produces the quickest photo-electrons, and that is why its photo-electric activity was discovered first (by Hertz). Red light endows the photo-electrons with so small a velocity that in the case of most *metals* (it is difficult to prove the photo-electric effect in the case of non-conductors) they remain embedded in the surface. The *alkalies* alone form an exception in this respect for reasons that are connected with their chemical behaviour in other directions (with their electropositive character).

A still greater degree of photo-electric activity than that of ultra-violet light is possessed by X-rays.

To bring into prominence the essential peculiarity of these discoveries we shall refer to the well-known conceptions of thermodynamics in this connexion. Thermodynamics investigates the conditions that govern the transformation of heat into work and, in particular, then, the production of kinetic energy. It teaches us to recognise temperature as the measure of the work-value of heat. Heat of higher temperature is richer, is capable of doing more work, than heat of lower temperature. Work may be regarded as heat of an infinitely high temperature, as unconditionally available heat.

In the case of the photo-electric effect, too, we are dealing with the production of kinetic energy which is drawn from the energy supply of the incident radiation (the fraction that is absorbed). We should expect more intense light to produce a greater photo-electric effect, than less intense light. But this, as we saw, is not true. The power of the light is not determined by its *intensity* but by its *frequency*. Blue light has great power, red light but little. The intensity determines only the quantity, but not the quality of the photo-electric action. These facts are very strange and depart greatly from the usual theoretical conceptions: they could not be explained on the basis of classical mechanics and optics. The key to them was furnished by the modern *theory of quanta*.

The quantum theory is a product of the twentieth century. It came to life on 14th December, 1900, when Max Planck gave the *Deutsche Physikalische Gesellschaft* a method of deriving the law of black body radiation, discovered by him shortly before, on the basis of a novel physical idea. As is well known, we apply the term **black body radiation** to that condition of equilibrium of heat radiation which comes about in a space enclosed by bodies of any kind, but at the same steady temperature. The term itself is due to the fact that radiation of just this intensity and spectral composition is also emitted by a black body, that is, a non-reflecting body at the same temperature.

The problem of radiation is rooted, on the one hand, then, in thermo-

dynamics, in the laws of the equilibrium of heat ; on the other hand, in electro-dynamics, in the laws according to which light- and heat-vibrations are excited, propagated, and absorbed. Planck spent years of consistently planned work in seeking to penetrate into the realm of electro-dynamics with thermodynamic principles. To retain agreement with observation and experiment he finally saw himself compelled to take a bold step leading away from the main road of our usual wave theory and to propound his *hypothesis of energy-quanta*. He postulated that *energy of radiation of any frequency ν whatsoever can be emitted and absorbed only in whole multiples of an elementary quantum of energy,*

$$\epsilon = h\nu \quad \dots \quad (1)$$

h is Planck's **quantum of action**. From measurements of radiation Planck soon succeeded in determining the value of his constant

$$h = 6.55 \cdot 10^{-27} \text{ erg secs.} \quad \dots \quad (2)$$

(Its dimensions are : energy \times time, the same as those of the mechanical "action" that occurs in the *Principle of Least Action*.)

This postulate does indeed upset our usual ideas of the wave theory. If wave energy is propagated continuously in space and becomes dispersed, how can it then condense at individual places so as to be absorbed in quanta of finite size? Moreover, how can it be emitted in finite quanta if, according to the laws of classical electro-dynamics (cf. for example, equation (2) of p. 25), every change of motion of the centre of vibration, which emits radiation, is accompanied by an instantaneous emission of radiation?

The hypothesis of energy-quanta, however, also affects classical statistics, that is, the method by which, for example, in the kinetic theory of gases we calculate the average result of many individual events which are not known to us separately. Like every problem of heat, so the problem of the equilibrium of radiation is ultimately a statistical question. The radiation that we observe is composed of an immense number of separate rays and separate events that occur in the emitting body. Now, Planck's investigations showed that classical mechanics could never lead to Planck's law of radiation, which has been verified by observation so excellently, and that, on the contrary, it would lead to a spectrum of heat radiation that would be in irreconcilable contradiction to the facts of experience.

It was just this statistical aspect of radiation that engaged the special attention of the discoverer of the quantum theory. He purposely brought the elementary atomistic phenomena which lie at the basis of radiation under one scheme, by operating with a "harmonic oscillator," a configuration that emits and absorbs radiation in a manner different from that of the real atoms. Einstein (and also Stark) maintained the opinion that the quantum conception must be valid not only in the statistical

equilibrium of radiation, but also in the elementary atomic phenomena. Einstein * called his extension of the principles of the quantum idea "a heuristic view-point concerning the production and transformation of light."

Disregarding for the present all obstacles we shall follow Einstein and describe the photo-electric effect thus. The radiation that is active photo-electrically is absorbed in energy-quanta $h\nu$ according to equation (1), and in a manner depending on its vibration number ν , it may generate an amount of kinetic energy $h\nu$ in the electrons dislodged from the metal. In this process the kinetic energy that we measure in our observations is less than that originally absorbed since the electron, in passing through the surface of the metal, has to perform work to get away. This work of escape P keeps the free electrons back in the metal if there is no photo-electric excitation, and it is different for different conductors. The difference in the values of P for two different metals finds expression in Volta's series of contact potentials, and is equal to the difference between the two contact potentials. Accordingly, we get for the velocity of escape v of the electrons, if m denotes the electronic mass :

$$\frac{mv^2}{2} = h\nu - P. \quad . \quad . \quad . \quad . \quad . \quad (3)$$

We shall leave unanswered the question whether P is a measure of only the work of escape from the surface of the metal or whether it is simultaneously a measure of the velocity of escape out of the atom (the so-called work of ionisation). If there are really free electrons in metals, then the latter work would be zero, and P would be a direct measure of the work of escape out of the metal; otherwise, P would be the sum of both amounts of work.

At the time that Einstein set up the relation (3), only qualitative evidence was available on which it could be based: the velocity of electrons emitted photo-electrically increased with increasing frequency of the exciting light (greater $h\nu$) and with the increasing electropositive character of metals (small P): ultra-violet light had been found to be more effective than red light; potassium, which is situated at the extreme end of the electropositive metals, was more sensitive than copper and silver. Quantitatively, Einstein could confirm the law only as far as order of magnitude was concerned. The wave-length of blue light is

$$\lambda = 0.4\mu = 4 \cdot 10^{-5} \text{ cms.}$$

The vibration number (frequency, or number of vibrations per second) corresponding to it is

$$\nu = \frac{c}{\lambda} = \frac{3}{4} \cdot 10^{15} \text{ sec}^{-1}$$

* Ann. d. Phys., **17**, 132 (1905); cf. *idem.*, **20**, 199 (1906) *Zur Theorie der Lichterzeugung und Absorption.*

and the corresponding energy-quantum according to equation (1) is

$$h\nu = 6.55 \cdot 10^{-27} \cdot \frac{4}{3} \cdot 10^{16} = 5 \cdot 10^{-12} \text{ ergs.}$$

According to (3) the kinetic energy of the escaping electrons is just as great, provided that we disregard the work of escape P for the present. Now, if we calculate the potential V which a cathode ray tube would have to possess to produce the same kinetic energy $\frac{1}{2}mv^2$ in a cathode ray tube, we also get

$$eV = 5 \cdot 10^{-12}.$$

If we take for e its value in the electromagnetic system, that is,

$$e = 1.6 \cdot 10^{-20} \text{ (see p. 15),}$$

we get

$$V = 3 \cdot 10^8 \text{ electromagnetic C.G.S. units} = 3 \text{ volts.}$$

The same order of magnitude, namely 1 to 2 volts, characterises the contact difference of potential between two somewhat distant metals of the Voltaic series, and hence also our work of escape P (which is, so to speak, the difference of contact potential of the metal relative to a vacuum). For the kinetic energy of the escaping electrons there then remains, according to (3), if we take P into account in our calculation, likewise an amount of 1 or 2 volts, corresponding to the above-mentioned order of magnitude of the results of observation.

The order of magnitude changes if we pass from visible light to Röntgen light (X-rays). The wave-length of the latter is, as we mentioned in the preceding paragraph, about 10^4 times smaller, and hence their vibration frequencies about 10^4 times greater, than the corresponding quantities in the visible region. If we carry out the same calculations for X-rays as made just above for blue light, we get for the kinetic energy of X-ray photo-electric cathode rays, or for the potential corresponding to this energy, in place of 3 volts, 30 kilovolts, that is, a voltage such as is usual for working a moderately hard X-ray tube. Clearly, the work of escape P , being only of a few volts, is to be neglected in comparison with a voltage of this magnitude. We thus arrive at an amount of energy that corresponds to that of the secondary cathode rays mentioned on page 23, of which we said that it is equal to that of the corresponding primary rays. This shows that the secondary cathode rays are to be regarded as a photo-electric effect of the primary X-rays and that their energy, too, is expressed by Einstein's formula as far as the order of magnitude is concerned.

Ten years after Einstein had proposed his law, it became clear that it was not only true in order of magnitude but that it gives the exact, quantitative expression for the photo-electric effect. This was shown in particular by Millikan* for the case of the sharply defined greatest energy

* R. A. Millikan, *A Direct Photo-electric Determination of Planck's "h,"* Phys. Rev., 7, 356 (1916).

which monochromatic light (light corresponding to a definite spectral line) is capable of generating. For if we plot the greatest energies that are obtained by using various spectral lines in a diagram, in which we plot the energies as ordinates and the vibration frequencies of the spectral lines used to produce them as abscissæ, the line connecting the points plotted exhibits a linear increase, the magnitude of which is given by the constant h .

That there is a maximum value of the energy generated and that just this and not some mean value of the energy follows Einstein's law is, in fact, to be expected according to quantum ideas. For the energy-quantum $h\nu$ denotes the energy which the incident radiation initially puts at the disposal of the electron for the purpose of photo-electric emission. This energy can, indeed, be reduced through secondary losses of energy in the metal, but it can never be exceeded. We have, there-

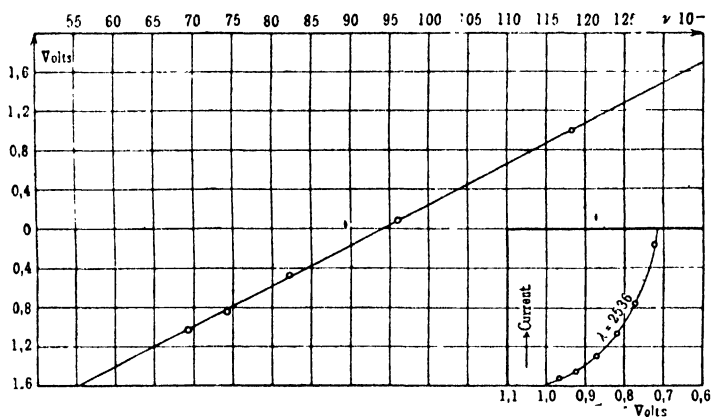

FIG. 12.

fore, to regard the photo-electric maximum* of energy as being primarily given and determined by the theory of quanta. It appears that this maximum of energy obeys Einstein's law very accurately.

We demonstrate this in the following picture (Fig. 12) by Millikan, which has been obtained for the case of lithium; the result for sodium looks quite similar. Millikan used as a source of light five mercury lines in succession. The corresponding five points of observation are indicated in the figure by small circles. The frequency number of the line

* About the same time as Millikan, Ramsauer investigated the photo-electric law of distribution, that is, how often, relatively, the various values of the kinetic energy, for light of a given frequency ν , are represented in the photo-electric emission. He found the distribution to follow a universal form, independent of the nature of the metal used and of the light used. The energy that occurs most often (corresponding to the maximum of the curve of distribution) follows, according to Ramsauer, a law that expresses linear dependence on the exciting frequency ν , which is of the kind given by Einstein and Millikan for the maximum energy. Cf. Ann. d. Phys., 45, 1121, (1914).

corresponding to the shortest wave-length, the so-called resonance-line of mercury $\lambda = 2536\text{\AA}$ ($\text{\AA} = \text{\AA}ngstr\ddot{o}m \text{ unit} = 10^{-8} \text{ cms.} = \frac{1}{10} \mu\mu$) is $\nu = 1.18 \cdot 10^{15}$; the frequencies of the others can be read off from the figure along the x -axis. Opposite the Li-plate is a so-called Faraday cage, carefully sheltered from electrostatic influences, which is connected with the electrometer: the plate gives up the photo-electric cathode rays, released by incident radiation, to this Faraday cage. The plate and the cage are kept in a vacuum. If the plate is now charged positively, the ejected electrons experience a restoring force. A certain intensity of charge just suffices to turn back all electrons, including those that are emitted perpendicularly to the plate with the maximum velocity. The reversing potential, in volts, corresponding to this charge is at the same time, according to the law of energy, a measure of the maximum kinetic energy of the incident light. Corresponding to every vibration frequency of the incident light there is a different photo-electric maximum of energy, that is, a different voltage of the reversing potential. Millikan next proceeds, by means of an auxiliary figure (see Fig. 12, the right-hand bottom corner), to determine graphically the voltage of the reversing potential for which the photo-electric current becomes just equal to zero.*

In the main part of Fig. 12 this voltage number is mapped out as the ordinate and the same is done in the case of the other four frequencies. The points obtained lie beautifully on a straight line (departing from it by less than 0.5 per cent). The inclination of the line, expressed in C.G.S. units, is:

$$h = 6.58 \cdot 10^{-27} \text{ erg secs. in the case of Li}$$

$$\text{and } h = 6.57 \cdot 10^{-27} \text{ erg secs. in the case of Na}$$

agreeing fully with Planck's value of h in equation (2).

In the realm of X-rays, too, we may regard Einstein's law as an *exact* expression of the facts and not only as being correct in order of magnitude: here we may state it in the simplified form in which the work of escape P is omitted (cf. p 38). Thus we write

$$eV = \frac{mv^2}{2} = h\nu \quad . \quad . \quad . \quad . \quad . \quad (4)$$

If we read this equation from right to left, it represents the process of generating secondary cathode rays by primary X-rays: it determines from the frequency ν of a monochromatic Röntgen radiation the maximum velocity v of the cathode rays which this radiation is able to release when it impinges on any arbitrary material substance, and it likewise determines the corresponding voltage that is equivalent to the

* The particular advance made by Millikan beyond his predecessors consisted in the accuracy with which he determined this reversing potential. This is expressed in the circumstance that the curve of our auxiliary figure cuts the x -axis in a well-defined point at an angle that is not excessively acute.

maximum velocity generated in the cathode rays. We have, as in the photo-electric effect, *the transformation of wave-radiation into corpuscular radiation*. The same equation, however, represents *the transformation of corpuscular radiation into wave radiation*. For if we read it *from left to right*, V denotes the voltage of the X-ray tube. This produces the primary cathode rays of velocity v : when the latter strike the anti-cathode, they produce X-rays, characteristic radiation, and impact radiation. The spectrum of the impulse radiation is, as we saw in the previous paragraph, continuous. This spectrum stretches from a small v (soft X-rays) up to a *sharply defined limit in the region of short frequencies*, which corresponds with the hardest X-rays that can be produced by the voltage V ; the frequency corresponding to this limit is given by equation (4). So, here too, *the relation between the voltage V of the tube and the limiting frequency ν is expressed by Einstein's linear law*. As V increases, the short wave limit of the continuous spectrum moves to higher frequencies. The frequency of the greatest intensity, as also the average hardness of the radiation, becomes displaced in the same sense. The well-known law (cf. p. 30), that the hardness increases with the voltage of the tube is thus likewise a consequence of Einstein's law; it is, in a sense, a more sketchy form of it.

In particular, we get as a direct result of the double reading of Einstein's law the equality, emphasised above (p. 23), between the velocity of primary and secondary cathode rays. The production of secondary cathode rays from primary X-rays seems a direct reversal of the phenomenon of the production of primary X-rays from primary cathode rays.

The existence of the short wave limit of the continuous spectrum is a main feature in the complete picture of X-ray phenomena. There seems no possibility of success in attempting to explain it from the point of view of the classical theory of radiation. However we may care to picture the details of the phenomenon of impulse radiation, the resolution of the radiation emitted into Fourier terms would, according to classical electrodynamics, lead to a spectrum that would stretch to infinity on the side of higher frequencies. Thus the existence of the short wave limit is an unmistakable hint that we must go further than the classical theory of radiation and work out a quantum theory. Einstein's law formulates this fact as compactly and precisely as can be desired. That it is quantitatively correct will be seen in Chapter III, § 7. Just as in the case of the photo-electric effect, the measurement of the short wave limit of the continuous X-ray spectrum may be elaborated so as to lead to a precise determination of the constant of radiation h .

We shall now at once go a step further to the extreme end of the scale of frequencies—to the γ -rays—and we shall discuss their connexion with β -rays. Concerning this connexion there are particularly convincing researches,* by Rutherford, Robinson, and Rawlinson, undertaken in the

* Phil. Mag., 26, 717 (1913), and 28, 281 (1914).

years 1913 and 1914, which give quantitative evidence. The β -rays of certain radium preparations (RaB and RaC, cf. the following section) have velocities which, over a certain region, approach the velocity of light, but within this region of velocity they, in the main, assemble at individual, discrete points. By means of magnetic deflection they can be resolved into a "velocity-spectrum." This velocity-spectrum is then observed once, at the beginning, with a wire brushed with the radium preparation, and then, after the wire has been surrounded by a lead envelope that absorbs the β -rays, the spectrum of the secondary rays is observed. In the latter case the primary β -rays remain imprisoned in the absorbing layer. But they absorb secondary γ -rays, for which the layer is transparent. What we observe when we apply magnetic deflection are the secondary β -rays produced in their turn by the γ -rays—in particular, those β -rays that are produced near the surface of the absorbing envelope and which escape without any considerable reduction of velocity. A comparison of the primary with the secondary spectrum shows that they are exactly identical (except for a certain broadening in the region of lesser velocities). This proves that the transition

$$\beta\text{-rays} \rightleftharpoons \gamma\text{-rays}$$

is a reversible phenomenon that is regulated accurately by the $h\nu$ -relation.

We have now to take only one step further to arrive from Einstein's law to one of the main pillars of Bohr's theory of spectral lines.

We have seen how energy of monochromatic frequency $h\nu$ is taken up by a metal atom and how it reappears as kinetic energy of a photo-electric electron. If we now suppose that the absorbed energy of vibration does not suffice to release the electron from the atom, then it will only effect a re-adjustment in the atom, in which the atom passes from a lower to a higher step of energy. We can imagine this transition to be similar to that of a weight which is lifted from a lower initial position to a higher final position. If W_a and W_e ($> W_a$) are the initial and final energies of the atom, respectively, then we get, as a counterpart to Einstein's photo-electric equation, *Bohr's fundamental equation for a phenomenon of optical absorption* :

$$h\nu = W_e - W_a \quad . \quad . \quad . \quad . \quad (5)$$

We saw, on the other hand, that an initially given amount of energy of cathode rays or its equivalent volt-number produces Röntgen radiation, the maximum $h\nu$ of which is equal to the initial energy. This maximum $h\nu$ is not reached in every elementary process because in general a fraction of the available cathode ray energy W_a is transformed into wave radiation and another (indefinite) fraction W_e remains in the form of cathode-ray energy. If we now suppose that the primary energy originates in the change of configuration of the atom, of which the initial energy is W_a and the final energy $W_e < W_a$, so we may here too, expect a radiation to appear thus

$$h\nu = W_a - W_e \quad . \quad . \quad . \quad . \quad (6)$$

This radiation is now strictly *monochromatic*, because in this case W_e , as well as W_a , is fixed as a discontinuous quantity by the configuration of the atom. In equation (6) we have *Bohr's fundamental equation for the phenomenon of optical emission*.

Just like Einstein's law, this extension of it by Bohr claims to be valid with absolute accuracy in the entire spectral region from the slowest heat rays to the most rapid X-rays and γ -rays. Thus this quantum law regulates in the same way as Einstein's law the transition of wave radiation into corpuscular radiation as well as the reverse process; it governs the phenomena of absorption as well as those of emission, in optical regions as well as in the region of high frequencies. There is no doubt that we are here dealing with one of the most mysterious of physical laws.

The photo-electric phenomena and the other phenomena of absorption in optical and X-ray regions certainly give the impression that wave energy as well as the energy of corpuscular radiation is concentrated at certain points. This brings us to the extreme view that light consists of "light-quanta" that leave the centre of emission with the speed of light. Particularly the facts of the production of secondary cathode rays by X-rays seems to admit of no other interpretation. In phenomena of optical absorption we see the same transformation of radiation energy $h\nu$ into mechanical work exerted on the electron take place in the interior of the atom. How is this transformation to be interpreted if the wave energy is not concentrated in the form of light-quanta, and is not available all at once?

There has been no dearth of attempts to reduce the contradiction between the "quantum" and the "classical" view of energy transference. In conjunction with Debye the author has put forward a view of photo-electric phenomena and a method of deriving Einstein's law,* which does not deprive radiation of the character demanded of it by the wave theory, that is, which does not require the use of compact elements of energy of amount $h\nu$ and which, instead, ascribes to the atom the property of being able to pile up energy of radiation to a limiting amount determined by the constant h . As soon as this limit is reached, the electron is supposed to be released from the atom and to escape with the energy which it has collected. Under certain conditions (chosen in rather an artificial manner) Einstein's law for the energy of the escaping electrons may be deduced. At the same time the "time of accumulation" that is necessary for the heaping-up of the energy $h\nu$ may be calculated. If a powerful source of light is assumed, then this time in the case of the photo-electric effect comes out fairly small (fraction of a second), but when the calculation is made for the conditions of the X-ray photo-electric effect, for which the energy-element $h\nu$ is much greater and the intensity of radiation is, in general, much smaller, impossible "accumulation times" come out, times of the order of magnitude of years! Yet experiment shows that, in

* Ann. d. Phys., 41, 873 (1913).

the case of X-rays as well as in that of ordinary light, the emission of electrons commences immediately, as soon as the exposure to the incident light begins, and ceases the moment the exposure is stopped. From the point of view of the wave theory the source of the great energy of emission remains incomprehensible. The phenomena actually occur as if in light of frequency ν there are ν energy-elements of the magnitude $h\nu$, which are ready at any moment to become transformed, according to Einstein's law (in atoms that are appropriate), into kinetic energy of electrons. Later, when we come to speak of the absorption and excitation of spectral lines, we shall find ourselves compelled to adopt this standpoint of "light-quanta."

On the other hand the continuous propagation of wave-energy is so firmly established for phenomena of interference and diffraction (also in the region of X-rays, owing to the Laue effect, cf. Chap. III) that it makes the idea of light-quanta appear quite out of the question. Modern physics is thus for the present confronted with irreconcilable contradictions and must frankly confess its "non liquet."

§ 7. Radioactivity.

Hitherto we have considered only the physical manifestations of radioactive processes. A few remarks about the chemical carriers involved must now be added.*

A characteristic feature of radioactivity is that it occurs essentially only in the case of the elements of greatest atomic weight. Uranium (*Ur-ahn* = original ancestor of the radium family) is the heaviest element, having an atomic weight 238.2. Thorium, the parent substance of the thorium family, is the second heaviest of the elements that were known before radioactivity (as its atomic weight = 232.15). It is therefore allowable to regard atoms that are too heavily loaded with matter as hypertrophic, configurations that are unstable and disintegrate into simpler forms.

We shall take for granted the sum-total of radio-chemical research in the form of the genealogical tree given in Table 1. How it became possible to set up these lines of descent will be made clear below (in the theory of disintegration), and also partly in the next chapter (§ 5, "Laws of Displacement"). It need only be remarked here that without this theory as a kind of Ariadne's thread it would have been impossible to find a means of locating the members of this manifold series of new elements. On the other hand we must mention that it is only the extraordinary sensitiveness of electroscopic observations of radioactivity, a sensitiveness which far exceeds that of the balance, that has enabled us to prove the existence of the products of disintegration, for these are often present in only very minute quantities.

* Cf., besides the comprehensive works mentioned in § 3, the résumé of Fajans in *Jahrg. 16 der Physik. Zeitschr.*, 1915: *Das periodische System der Elemente, die radioaktiven Umwandlungen und die Struktur der Atome*. Cf. also *Radioaktivität und die neueste Entwicklung der Lehre von den chemischen Elementen*. 3. Aufl., 1921, by the same author in *Sammlung Vieweg*.

Formerly, three radioactive families were distinguished, the Uranium-radium Group, the Actinium Group, and the Thorium Group. It was, however, conjectured that the actinium series was a branch of the uranium series. This has been confirmed by Hahn and Meitner's discovery of protactinium; the exact point at which the branching commences is not quite certain (it is at Uranium II in our table). Thus there remain only two families: the Uranium family and the Thorium family (*vide* Table 1 on the following page).

The upper rows of our genealogical tree shows the stages of development from the two parent substances U and Th as far as the three emanations (the inert gases). The subsequent development, which runs parallel in the three, now distinct, families, is shown in the lower rows. In each case they end with an element having the character of lead. The actinium series ends with AcD (actinium lead), and the thorium series ends with ThD (thorium lead), but we are not yet certain whether these are really permanent final products or only intermediate products that disintegrate exceedingly slowly and whose further disintegration is yet unknown. In the radium series the analogous substance RaD is certainly *not* a final product: to it there is linked the series RaE, RaF = polonium, and RaG = radium lead. The similarity of the three trees of descent between the emanations and the D-products is shown not only in the number of products of disintegration and their position in the natural series of elements (cf. Table 4 in Chap. II, § 5) but also in the mode of disintegration (denoted in our table by the letters α and β printed above the arrow used to signify transformation; γ denotes that γ -rays are present). At corresponding positions in the genealogical trees the disintegration is effected either by an α -transformation (emission of helium) or a β -transformation (electron emission), or by a simultaneous α - and β -transformation. The notation here adopted takes due account of this parallelism of disintegration. It has been suggested by Stefan Meyer and Schweidler and differs from that formerly in use (which arose historically and which is thus less systematic) in the names given to the C- and D-products.

Below the symbol of each element we have recorded the "**half-value time**"; this is the time which has elapsed when half the body is disintegrated. It is proportional to the "mean duration of life" of the element. We shall explain later how it is determined. The abbreviations a, d, h, m, s, denote: year (*annus*), day, hour, minute, second. We thus have long lived elements with spans of life stretching over millions of years (U has a half-value time of $5 \cdot 10^9$ years, and Th has one twice as long) and short-lived elements which live only for seconds or fractions of a second. The elements whose lives are shortest are to be found among those designated by C' :

RaC' has 10^{-6} seconds, AcC' $5 \cdot 10^{-3}$ s, ThC' 10^{-11} s.

TABLE I*

UI $\xrightarrow{\alpha}$ 4.5.10 ⁸ a	UX ₁ $\xrightarrow{\beta\gamma}$ 23.8 d	UX ₂ $\xrightarrow{\beta\gamma}$ 1.15 m	U II $\xrightarrow{\alpha}$ (2.10 ⁶ a)	Io $\xrightarrow{\alpha}$ 9.10 ⁴ a	Ra $\xrightarrow{\alpha}$ 1580 a	Ra-Em $\xrightarrow{\alpha}$ 3.85 d
	UY $\xrightarrow{\beta}$ 24.6 h			Pa $\xrightarrow{\alpha}$ 12,000 a	Ac $\xrightarrow{\beta}$ (20 a)	RdAc $\xrightarrow{\alpha}$ 18.9 d
						AcX $\xrightarrow{\alpha}$ 11.2 d
						Ac-Em $\xrightarrow{\alpha}$ 3.92 s
Th $\xrightarrow{\alpha}$ 22.10 ¹⁰ a	MsTh1 $\xrightarrow{(\beta)}$ 6.7 a	MsTh2 $\xrightarrow{\beta\gamma}$ 6.2 h	RdTh $\xrightarrow{\alpha}$ 1.90 a	LoX $\xrightarrow{\alpha}$ 3.64 d	Th-Em $\xrightarrow{\alpha}$ 54.5 s	
Ra-Em $\xrightarrow{\alpha}$ 3.85 d	RaA $\xrightarrow{\alpha}$ 3.05 m	RaB $\xrightarrow{\beta\gamma}$ 26.8 m	RaC $\xrightarrow{\beta\gamma}$ 19.5 m	RaC' $\xrightarrow{\alpha}$ (10 ⁻⁶ s)	RaE $\xrightarrow{\beta\gamma}$ 4.85 d	RaF $\xrightarrow{\alpha}$ (Polonium) 136.5 d
				RaC'' $\xrightarrow{(\beta\gamma)}$ 1.32 m	RaD $\xrightarrow{\beta\gamma}$ 16 a	RaG $\xrightarrow{\alpha}$ (Radium lead) ∞
Ac-Em $\xrightarrow{\alpha}$ 3.92 s	AcA $\xrightarrow{\alpha}$ 2.10 ⁻³ s	AcB $\xrightarrow{\beta\gamma}$ 36.1 m	AcC $\xrightarrow{\beta}$ 2.16 m	AcC' $\xrightarrow{\alpha}$ (5.10 ⁻⁶ s)		
				AcC'' $\xrightarrow{\beta\gamma}$ 4.76 m	AcD $\xrightarrow{\alpha}$ ∞	
Th-Em $\xrightarrow{\alpha}$ 54.5 s	ThA $\xrightarrow{\alpha}$ 0.14 s	ThB $\xrightarrow{\beta\gamma}$ 10.6 h	ThC $\xrightarrow{\beta}$ 60.8 m	ThC' $\xrightarrow{\alpha}$ (10 ⁻¹¹ s)	ThD $\xrightarrow{\beta\gamma}$ 3.20 m	(Thorium lead) ∞

* The abbreviations denote: U = Uranium, Ra = Radium, Io = Ionium, Em = Emanation, Th = Thorium, Ac = Actinium, Ms = Meso, Rd = Radio, Pa = Protactinium. The numbers have been taken from St. Meyer, "Radioaktive Konstanten nach dem Stande von 1920," Jahrbuch der Radioaktivität, 17, 80 (1920).

These numbers like all the bracketed half-value times have been found, not from observation, but from calculation. Within the region above mentioned (from the emanation to the lead group) there is also a certain parallelism between the half-value times of the three families.

The branching between RaC and RaD over RaC' and RaC'', and the exactly corresponding branching of the Th- and Ac-tree is of special interest. The fact that RaC is transformed into different products (RaC' and RaC'') according as it disintegrates by a β - or an α -transformation, is intelligible. But the fact that these products, when subjected to the same transformations but interchanged (i.e. by an α - and a β -transformation respectively), resolve into the same element RaD will be made plausible by the displacement laws of Chap. II, § 5, but it is not empirically certain. In addition to these ramifications we have in our table also the (at present hypothetical) branch at UII which is supposed to consist of a double α -radiation. The branch product UZ (half-value time 6.7 hours), which emits β -radiation and was discovered by O. Hahn,* has not been included in our table as the point at which it branches off (UX₁?) and its further development are not known with certainty.

We thus see that in virtue of these ramifications there are represented in our genealogical tree not only children and grand-children but also brothers and cousins of the first degree as well as of higher degrees.

Our next step is to give a short note on the laws of radioactive disintegration. These laws arise directly and are of an extraordinarily simple type. Being fully independent of temperature and pressure, they thus differ fundamentally from the laws that govern ordinary chemical transformations. Nor are they dependent on whether the active substance is present as an element or a salt, whether it is pure or mixed with other substances. Everything seems to support the view that we are not dealing with an action of one atom on another but rather with some inner atomic process.

In Fig. 13 we consider a particularly simple case. We are dealing with the disintegration from U into UX, or, more exactly, from UI into UX₁, that is, with the process that stands at the head of our table. Let us take the β -ray activity as an indicator. That is we shall suppose the α -rays to be eliminated by absorption for the sake of our present argument.† Only the β - and γ -rays penetrate into the electroscope, ionise the air, and produce a charge which flows into the leaves of the electroscope and which serves as a measure of the number of ions formed. But since γ -rays are ineffective in forming ions, as compared with β -rays, we need here regard the activity as referring solely to β -ray activity; "inactive" means "producing" no β -rays.

The preparation with which we start is not pure uranium but already contains a certain very small percentage of UX. It is possible to

* Ber. d. Deutsch. Chem. Ges., 54, 1131 (1921); Naturwissenschaften, 1921, p. 84.
 † $\frac{5}{100}$ mm. of Al are sufficient to absorb the most rapid α -rays almost entirely.

precipitate the latter from the uranium by repeated application of barium sulphate. The UX thus isolated carries away the whole activity of the preparation with it, and the U itself is left behind entirely inactive at first. In the figure we have thus set the initial activity of U equal to zero, and that of UX equal to 1. From these initial states onwards the activity of the UX diminishes regularly to zero, whereas that of U simultaneously recovers and increases from 0 to 1. By comparing the two curves we see that their ordinates at each corresponding point add up to 1. If $J_1(t)$ is the activity of UX at the time t , and $J_2(t)$ that of U at the same moment, then we have:

$$J_2(t) = 1 - J_1(t) \quad . \quad . \quad . \quad . \quad (1)$$

Hence although these products are distinct from one another (chemically, and, for example, separated by a considerable distance in space) they yet continue to act in full accord with one another: the

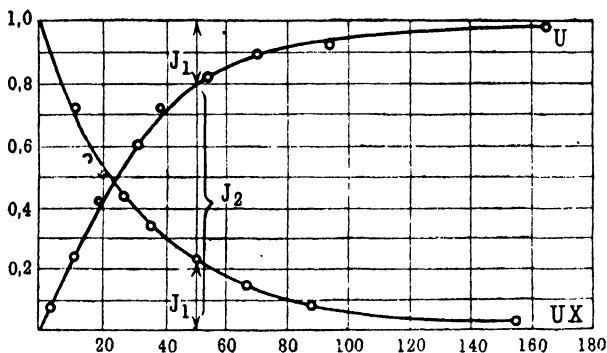

FIG. 13.

activity lost by the one is gained by the other; the sum of their activities is constant just as would have been the case if we had not separated them chemically.

According to the disintegration theory of Rutherford and Soddy, the explanation is as follows. The constitution of the atom, and this alone, invests any arbitrarily chosen atom with a certain *probability* that it will disintegrate in an arbitrarily chosen unit of time. This probability is called the **radioactive constant** (or decay constant) of the atom. From this there follows the essential principle of the theory of disintegration: **The number of atoms that decay per unit of time is equal to the radioactive constant multiplied by the number of atoms still present** (namely, equal to the probability of decay of an atom multiplied by the number of atoms). On the other hand the activity of the prepared substance is, except for a constant depending on the apparatus, equal to the number of atoms that decay per unit of time (in our case the atoms disintegrated

by the β -transformation). In conjunction with the above principle, this leads to :

$$J(t) = C\lambda n \quad \dots \quad (2)$$

where J = activity at the time t , C = the apparatus constant, λ = the radioactive constant, and n = the number of radioactive atoms at the time t .

We next apply this principle to the two curves of Fig. 13.

I. In the case of UX isolated from its parent substance, the number of atoms n is changed only through the decay of the atoms present. Therefore the number of atoms that decay in time dt is $-dn$. From this, and from the principle of the disintegration theory we get the following differential equation for the disintegration of UX :

$$-dn = \lambda n dt \quad \dots \quad (3)$$

Thence it follows that if n_0 denotes the initial number of atoms of UX, and if e is the base of natural logarithms,

$$n = n_0 e^{-\lambda t} \quad \dots \quad (4)$$

and, by (2),

$$J(t) = C\lambda n_0 e^{-\lambda t} \quad \dots \quad (5)$$

In our figure we chose our unit so that $J(0) = 1$. Hence we must set

$$C\lambda n_0 = 1 \quad \dots \quad (6)$$

and thus get

$$J_1(t) = e^{-\lambda t} \quad \dots \quad (7)$$

The curve in Fig. 13, which was obtained from direct observation, agrees exactly with this exponential law. Its rate of decline allows us to determine the decay or radioactive constant λ .

II. In the case of the U that has been purified of UX, let N be the number of uranium atoms at the time t , N_0 the initial number, Λ the radioactive constant of uranium. The decay again takes place according to the law (3), which now assumes the form :

$$-dN = \Lambda N dt, \quad N = N_0 e^{-\Lambda t} \quad \dots \quad (8)$$

Now, the radioactive constant Λ of the uranium is extremely small compared with the radioactive constant λ of the UX, i.e.

$$\Lambda \ll \lambda \quad \dots \quad (9)$$

Hence, within a period of observation that is not reckoned in millions of years, we may reasonably set :

$$\Lambda t = 0, \quad e^{-\Lambda t} = 1 \quad \dots \quad (10)$$

and hence, by (8),

$$N = N_0, \quad -\frac{dN}{dt} = \Lambda N_0 \quad \dots \quad (11)$$

Measurement of the activity in this case discloses nothing of this change, since it is an α -transformation. For this measurement depends only on the β -transformation of the UX. Now a UX-atom arises from each U-atom. If the latter were not to decay, we should have simply $dn = -dN$ and, by (11),

$$\frac{dn}{dt} = \Lambda N_0, \quad n = \Lambda N_0 t. \quad . \quad . \quad . \quad (12)$$

The number n of UX-atoms and therefore also the activity $J(t)$ of UX would thus increase uniformly with the time, and would thus be represented by a straight line in Fig. 13, namely the initial tangent of the curve there shown as $J_2(t)$. But the increase does not continue indefinitely, for the UX-atoms decay in their turn: a state of equilibrium is gradually reached, in which just as many UX-atoms decay as are formed. If n_0 is the number when equilibrium is reached, then the number of UX-atoms which decay per unit of time is, according to (3), λn_0 , the number of those being formed is equal to the U-atoms that are decaying, and $= \Lambda N_0$, by (11). Hence, in radioactive equilibrium:

$$\lambda n_0 = \Lambda N_0 \quad . \quad . \quad . \quad . \quad (13)$$

In the state of radioactive equilibrium, the number of atoms of parent substance and child product are in the inverse ratio of the corresponding radioactive constants.

This state of equilibrium existed during the initial separation of the U and the UX. The equilibrium number n_0 just calculated is thus identical with the initial number of atoms n_0 of UX in equation (4). In the state of equilibrium the activity of UX will be, according to (2) and (6),

$$J_2 = C\lambda n_0 = I.$$

Our curve $J_2(t)$ which was originally an oblique straight line thus curves round into a horizontal straight line, which is at unit distance from the time axis.

If, further, we wish to find the law of curvature, we must complete (12) thus:

$$\frac{dn}{dt} = \Lambda N_0 - \lambda n$$

by taking account not only of the production of the UX-atoms but also of their decay. As a result of (13) this equation may be written:

$$\frac{dn}{dt} + \lambda n = \lambda n_0$$

and may be integrated by simple mathematical rules, if we take into consideration the initial conditions $n = 0$, $t = 0$, thus:

$$n = n_0(1 - e^{-\lambda t}).$$

By multiplying this by $C\lambda$ we get the activity $J_2(t) = C\lambda n$. From (6) we get for the latter:

$$J_2(t) = 1 - e^{-\lambda t} \quad . \quad . \quad . \quad (14)$$

Thus $J_2(t)$ increases according to the same exponential law as that by which $J_1(t)$ decreases. $J_2(t)$ and $J_1(t)$ sum up to unity.

This is the full explanation of Fig. 13. The same diagram gives us the semi-decay time of UX. For it, the relation holds:

$$e^{-\lambda t} = 1 - e^{-\lambda t} \text{ or } e^{-\lambda t} = \frac{1}{2} \quad . \quad . \quad . \quad (15)$$

The abscissa of the point of intersection is thus the time which has elapsed when the exponential function has diminished to a half of its initial value, i.e. at the time $t = 0$. In our case the curve tells us that the half-value (or semi-decay) time t_{11} is equal to 23.8 days.

In addition to the half-value time we also arrive at the radioactive constant. For from (15) it follows that

$$\lambda t_{11} = \log_e 2 = .693 \quad . \quad . \quad . \quad (16)$$

The radioactive constants are in the inverse ratio of their half-value times. The values of these times are given in Table 1.

Closely related to the conception of half-value time we have the conception of *mean length of life* or *average life*. If we denote the latter by t_L , we get in place of (16),

$$\lambda t_L = 1 \quad . \quad . \quad . \quad . \quad (17)$$

For, as in social statistics, we define the mean length of life by first multiplying each age by the relative number of the individuals that just attain this age but do not exceed it and then summing all these products of age and relative number. In our case, as we see from (3) and (4), $-dn$ is the number of atoms which at the time t decay within the time-interval dt , and n_0 the total number of atoms initially present, thus

$$\frac{-dn}{n_0} = \lambda e^{-\lambda t} dt$$

signifies the relative number with which we are here concerned. By multiplying it with the corresponding t and summing for all t 's, we get the required average length of life:

$$t_L = \int_0^{\infty} t \left(\frac{-dn}{n_0} \right) = \int_0^{\infty} t \lambda e^{-\lambda t} dt \quad . \quad . \quad . \quad (18)$$

Equation (17) follows simply from this definition if we multiply both sides of (18) by λ and introduce $x = \lambda t$ as a new variable of integration:

$$\lambda t_L = \int_0^{\infty} x e^{-x} dx = 1.$$

By comparing (16) with (17) we see that we get the average lengths of life of the radioactive elements by dividing the numbers of Table 1 by $\cdot 693$.

In general, conditions are not as simple as in the example we have so far discussed. This simplicity was due in the first place to the fact that the life of UI is very long compared with that of UX_1 . We made use of the resultant simplification ($\Lambda \ll \lambda$) in passing from equation (8) to equation (11). But then the further fact comes into consideration that the life of UX_2 ($t_H = 1.15$ minutes) is very short compared with the life of UX_1 (cf. Table 1), and that the life of UII is again extraordinarily long ($t_H = 2.10^6$ years). The result is that immediately following on the disintegration of each UX_1 -atom, i.e. at intervals of probably about a minute, the decay of the new-born UX_2 -atom and the transition to the UII-atom takes place. The decay is accompanied by β - and γ -radiation, and therefore increases the ionisation produced by the decay of UX_1 . In fact, on account of the greater hardness of the β -radiation of UX_2 , it forms the main part of the entire ionisation that is observed. The addition of the decay of UX_2 does not, however, bring about to any appreciable extent a delay in the rate at which the activity dies down, or a change in the exponential law given by the curve. This allowed us to use the short term "UX," as referring to a uniform product, in our explanation of Fig. 13, thus treating the two elements UX_1 and UX_2 conjointly as was the practice formerly before these two elements had been separated. Nor does the activity of UII, which remains after the decay of UX_1 and UX_2 , cause a change in the course of the activity curve, since, being an α -activity, it evades measurement.

We get a complete picture of the great possibilities of the theory of decay only when we consider the course of the activity in a case in which several products of approximately the same length of life participate. The classical example is given by the precipitate which is produced by radium emanation. This precipitate consists of a mixture of RaA, RaB, RaC, which becomes transformed into the long-lived RaD. The short-lived products RaC' and RaC'' are included here under the symbol RaC. The α -activity curve of this mixture is shown in Fig. 14. Since RaB emits only β - and γ -rays (cf. Table 1), it does not come into account for the measurement of α -activity, except in so far as it becomes changed into RaC. At the beginning of the measurement the products A, B, and C are in equilibrium. By (13) we then have

$$\lambda_A \cdot N_A = \lambda_B \cdot N_B = \lambda_C \cdot N_C$$

if N_A , N_B , N_C , denote the amounts of these products present (properly the numbers of atoms of each). These amounts are different. By (2), however, the activities of RaA and RaC, which we shall denote briefly by A and C, are equal when in radioactive equilibrium, as long as the apparatus constant that comes into question may be regarded as constant. In the case of RaB, which has no α -activity,

this constant is equal to zero. In Fig. 14 we therefore make the curves A and C start with the same co-ordinate, whilst B starts with the ordinate zero. The curve B, which represents the indirect contribution of RaB to the α -radioactivity (this contribution asserts itself gradually), ascends by degrees, like the curve for J_2 in Fig. 13, in proportion as RaB produces RaC, but not to a constant value, as did $J_2(t)$ earlier, but to a maximum (on account of the limited life of RaB), and then gradually drops to 0 again. The sum of the ordinates of B and C has been plotted as the curve $L = B + C$ and shows the activity of the whole RaC that is present (namely that which is originally present and gradually dissociates, and the RaC which is developed from RaB). In actual measurement we get the curve $L + A = A + B + C$ for the whole activity. Its quick descent at the beginning betrays the presence of the comparatively short-

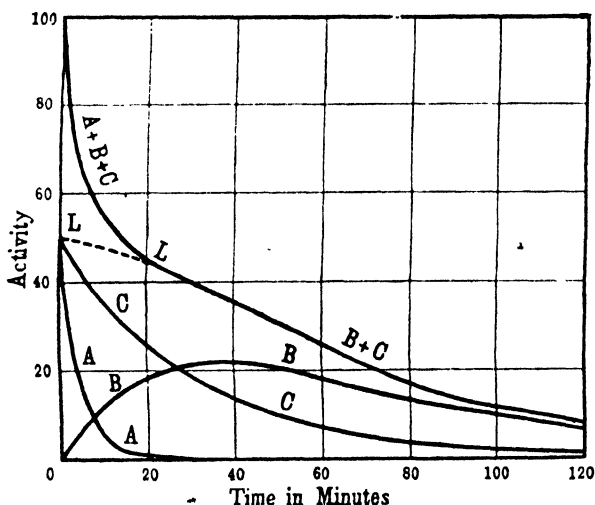

FIG. 14.

lived component A (half-value time 3 minutes). Its later more gradual descent points to components whose lives are longer (half-value time of RaB is 27 minutes, of RaC is 19.5 minutes). The theory of decay gives us as the theoretical representation of this curve, $A + B + C$, the sum of three exponential functions whose exponents are $-\lambda_A t$, $-\lambda_B t$, $-\lambda_C t$ and whose coefficients depend only on λ_A , λ_B , λ_C . We must use analysis to find these three unknowns λ_A , λ_B , λ_C . The fact that this analysis is possible, that is, that the results of observation may be represented accurately by superposing three exponential curves with appropriately chosen exponents and coefficients, proves that only three components whose lives are of the same order of length have contributed to the activity that has been measured. It may be remarked that in the preceding case a direct separation of the products A, B, and C is also possible by physical and chemical methods.

These few examples of the observations furnished by radioactive researches conclude our note on the radioactive series of transformations. It is hoped that they will have given the reader on the one hand a picture of the simplicity and capabilities of the theory of decay, on the other hand an idea of the methods that have led to the genetic relationships recorded in Table 1. We have now only to touch on two points of more general significance.

Our first question is whether radioactivity is a peculiarity of the heavy metals uranium and thorium or whether it is a general property of matter. The only certain fact that can be stated is that potassium and rubidium both exhibit a feeble β -activity. So that even if a high atomic weight doubtless favours radioactive decay, it is not the deciding factor for this activity. The assumption, that there are also genetic relationships between other elements and that they can be proved by the existence of radioactive transformations, is at any rate supported by the examples of K and Rb. It receives weight from the regular connexion between the atomic weights of the periodic system, to which we shall turn our attention in the next chapter.

Then there is the second question: Whence does the energy of radioactive actions come? At the beginning of §3 we saw that the energy of the α - and β -rays is many times more than that which any of our present technical means will allow us to produce in the case of canal and cathode rays. When the rays are kept back in the prepared substance, they produce and maintain an increase in the temperature of the substance, which is several degrees higher than that of the surrounding air. The heat energy generated by 1 gm. of radium amounts to about 100 calories per hour. A familiar problem of long standing asks how the energy which the sun loses by radiation is continually replaced. In this case, too, reference has been made to the apparently inexhaustible supplies of energy derived from radioactive processes. Whence does all this energy come? The answer is: from the interior of the atom, or, more precisely, from the innermost part of the atom, from the "nucleus" of the atom. We thus indicate the rôle which has to be assigned to radioactivity in our theory of the atom. The sources of energy which thus make their entrance into the outer world are of an order of magnitude quite different from the energies of other physical or chemical changes. They bear witness to the powerful forces that are active in the interior of the atoms (in the nuclei). This inner world of the atom is generally quite shut off from the outer world. It is not influenced by the temperature or pressure conditions that exist outside. It is governed by the law of probability, the law of spontaneous decay that can in no wise be influenced. Only as an exception is a door left open which leads from the inner world of the atom into the outer world. The α - and β -rays that are hereby emitted are emissaries from a world otherwise closed.

CHAPTER II

THE NATURAL SYSTEM OF ELEMENTS

§ 1. Small and Great Periods. Atomic Weights and Atomic Numbers

IN the face of the manifold of elements which were brought to light by the alchemists of the Middle Ages and by the research chemists of the eighteenth and nineteenth centuries the human intellect has never quite lost the view that unity and order exist among them. The old postulate of natural philosophy that there must be a common basic substance in all matter recurred again and again, particularly in the form of Prout's hypothesis (1815), because only the fulfilment of this condition could give us hope that we should succeed in understanding fully chemical action.

This goal has assumed a more definite shape since the discovery of the natural or periodic system of the elements by Lothar Meyer and Mendeleef about 1870. In this system, as is well known, the elements are written down in the order of increasing atomic weights, the series being broken off at appropriate points. Chemically related elements are written in the same vertical column, e.g. the alkalis, Li, Na, K, Rb, Cs, in the first column; the halogens, F, Cl, Br, I, in Column VII; since 1895 (Rayleigh and Ramsay) the inert gases, He, Ne, A, Kr, X, Em, have become added as Column VIII (cf. Table 2).

In general, the number of the column is the same as the oxygen-valency of the elements contained in it. The valency increases by one for every step from left to right in the periodic system. On the other hand, a different kind of valency, the hydrogen-valency, increases in the periodic system from right to left; this is particularly pronounced in the columns from VII to IV. As the oxygen-valency increases the electro-positive character (basic nature) becomes stronger and passes over into the electronegative character (acidity).

In this mode of tabulation the system of elements seems, externally at least, to be built up of periods of eight. Before the discovery of the inert gases they were true "octaves" in the musical sense, i.e. periods of seven (Newlands, 1864). The structure in periods of eight is, however, only apparent, for the periodic system has not so simple a periodicity. At the beginning, for example, there is a period of only two elements (H and He). Then there follow two periods of eight, the two "small" periods of eight exactly corresponding elements. They are succeeded by two "great" periods of eighteen elements, which can be forced into the

TABLE 2

	I	II	III	IV	V	VI	VII	VIII
1	1 H 1.008							2 He 4.00
2	3 Li 6.94	4 Be 9.01	5 B 10.82	6 C 12.00	7 N 14.01	8 O 16.00	9 F 19.0	10 Ne 20.2
3	11 Na 23.00	12 Mg 24.32	13 Al 27.1	14 Si 28.3	15 P 31.04	16 S 32.06	17 Cl 35.46	18 A 39.88 ←
→	19 K 39.10	20 Ca 40.07	21 Sc 45.1	22 Ti 48.1	23 V 51.0	24 Cr 52.0	25 Mn 54.93	26 Fe 27 Co 55.84 58.97 ↔ 58.68
4	29 Cu 63.57	30 Zn 65.37	31 Ga 69.9	32 Ge 72.5	33 As 74.96	34 Se 79.2	35 Br 79.92	36 Kr 82.92
	37 Rb 85.45	38 Sr 87.63	39 Y 88.7	40 Zr 90.6	41 Nb 93.5	42 Mo 96.0	43* 96.9	44 Ru 45 Rh 101.7 102.9
5	47 Ag 107.88	48 Cd 112.40	49 In 114.8	50 Sn 118.7	51 Sb 120.2	52 Te 127.5	53 J 126.92	54 X 130.2
	55 Cs 132.91	56 Ba 137.37	Rare earths	57 La 139.0	58 Ce 140.25	59 Pr 140.9	60 Nd 144.3	61 Eu 152.0
6	79 Au 197.2	80 Hg 200.6	81 Tl 204.4	82 Pb 207.20	83 Bi 209.00	84 Po (210.0)	85* (210.0)	76 Os 77 Ir 190.9 193.1
7	87* (222.0)	88 Ra 226.0	89 Ac (226)	90 Th 232.12	91 Pa (231)	92 U 238.02	78 Pt 195.2	86 Em (222.0)

Rare	57 La	58 Ce	59 Pr	60 Nd	61*	62 Sm	63 Eu	64 Gd
	139.0	140.25	140.9	144.3	152.0	157.3	162.5	173.0
Earths:	65 Tb	66 Dy	67 Ho	68 Er	69 Tm I	70 Yb	71 Lu	72 Tm II
	159.2	162.5	163.5	167.7	168.5	173.5	175.0	(178)

The numbers preceding the symbols of the elements denote the "atomic numbers"; the numbers below them denote the atomic weights.

scheme of series of eight only by somewhat artificial reasoning. As a matter of fact the alkalis, halogens, inert gases, and altogether the elements which exhibit exactly corresponding chemical behaviour follow one another after a further eighteen steps and are thus separated in our scheme by an intermediate series. By writing the terms on the right or left side of the individual spaces we succeed in making only those elements that correspond exactly lie in a vertical line. The fact that H, strictly speaking, belongs neither to the series of the alkalis nor to that of the precious metals, Cu, Ag, Au, is indicated by placing H in the middle of the space. Likewise C and Si are placed in the middle between the two sub-groups of Column IV. It is to be noted, however, that the elements that lie consecutively in the same vertical column but are not written in an exact vertical line, are related in certain ways. For example, Cu and Ag are univalent just like the alkalis in the same column; Zn and Cd are divalent like the alkaline earths, and so forth. This "secondary" relationship becomes weaker at the end of the horizontal series, particularly in Column VIII, in which we group with the inert gases the triads, Fe, Co, Ni, and Ru, Rh, Pd, constellations of elements that are interrelated among themselves, but are absolutely dissimilar from the inert gases. It is only by uniting these triads in one column that the number 18 of the great period can be adapted to fit the double number 2 . 8 of the small periods.

The great periods are then followed by a very great period of thirty-two elements which begins in the regular fashion with an alkali (Cs) and ends with an inert gas (Em). It, too, has its representative in Column VIII, a triad Os, Ir, Pt. But the whole series of rare earths (stretching from La to Tu_{II}), sixteen in number, will admit no periodicity and can in no way be inserted in the Columns I to VIII. As we are dealing, in their case as well as in that of the triads, with elements that are closely related chemically, we may group them together into a "hexadecade" (a group of sixteen), for which there are two empty spaces in the Columns III and IV. If it were possible to print them so, we should insert this hexadecade in Columns III and IV; instead of this, however, they had to be printed separately below. Written in this way the period of thirty-two elements also appears distributed among the spaces of two horizontal series, whereby exactly corresponding elements, separated by a horizontal row lie below the corresponding elements of the period of 18, thus W lies under Cr and Mo, Au under Ag and so forth.

This greatest period is followed by a series of only six elements which end with the heaviest element uranium. But it is quite admissible to imagine this series continued, say to the number of thirty-two terms, and to assume that it is only due to reasons of instability that the later elements no longer exist. The facts of radioactive decay (cf. Chap. I, § 7), indeed encourage the view that elements heavier than uranium are possible in themselves although they cannot exist under the conditions of our earth.

The periodic numbers 2, 8, 18, 32, with which we are thus left may finally be written in the following somewhat cabalistic form suggested by Rydberg:

$$2 = 2 \cdot 1^2, \quad 8 = 2 \cdot 2^2, \quad 18 = 2 \cdot 3^2, \quad 32 = 2 \cdot 4^2.$$

The newest reflections of Bohr, as expressed in his letter, "Atomic Structure," in *Nature* (24th March, 1921), seem to show the way in which this series of numbers is to be interpreted. To make their physical meaning clear he has written the right-hand factors in the following form:

$$2 = 1 \cdot 2, \quad 8 = 2 \cdot 4, \quad 18 = 3 \cdot 6, \quad 32 = 4 \cdot 8.$$

When we write down the natural system of the elements in the order of increasing atomic weights; we find that at four points the natural order is transgressed. There is no doubt that we must write the inert gas A before the alkali K, although the atomic weight of the former is greater than that of the latter. Furthermore, Co must come before Ni and Te before J, in spite of the order of atomic weights. After the recent discovery of protactinium we have the fourth exception, for we must set the series Th and Pa in the reverse order of their atomic weights. These necessary reversals of order have been indicated in the table by a double arrow. The method of X-ray analysis will remove these blemishes in the system and will restore the natural order of the elements. This method will show that the atomic weight is not the true regulative principle in the natural system, but that it is only a complicated and as yet unexplained function of the true "**atomic number**" (*Ordnungszahl*).

The true atomic (or series) number is simply the number which gives the position of the element in the natural system when due account is taken of chemical relationships in deciding the order of each element. In our table this number is printed directly before each element.

By arguing on the basis of the periodic system it was possible some time ago to predict unknown elements and to discover them subsequently. These are the elements bearing the national names, Gallium (1875, Lecoq de Boisbaudran), Scandium (1879, Nilson), Germanium (1886, Winkler), Polonium (1898, Madame Curie). The former three had been predicted by Mendeleef and their properties had been accurately described. Nowadays we can give the exact number, five, of the still existing gaps in the system by means of the method of X-ray spectroscopy. These have been marked in the table by a star. In conformity with the position of the missing elements, they should be called eka-manganese, eka-eka-manganese, eka-iodine, and eka-caesium; the fifth unknown element is situated in the group of rare earths.

The atomic weights, with a regularity far exceeding the bounds set by the laws of probability, are integral numbers or very nearly so when referred to oxygen = 16. This integral property agrees with Prout's hypothesis (that elements are composed of hydrogen atoms). There are

certain exceptions (e.g. Cl = 35.46, and Cu = 63.57), but they are rare.

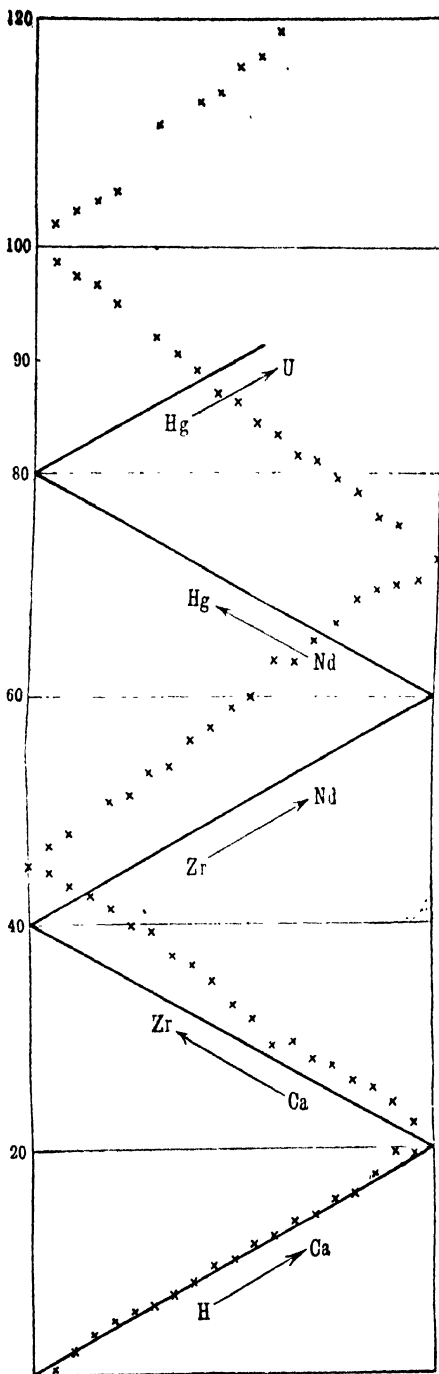

FIG. 15.

We shall revert to these exceptions and to their elimination by F. W. Aston in the fifth section of this chapter. Whole numbers of the form, $4n$ and $4n + 3$, are particularly frequent, the former generally in even spaces, the latter in places where the atomic number is odd.

Thus, if we compare an element with the next but one element, we get for the difference of their atomic weights as a rule approximately four. Hence the average increase in the atomic weight as we pass from element to element is not one but two. Or, in other words, *the atomic number of the element does not on the average coincide with the atomic weight, but with the half of the atomic weight.* This rule certainly holds only at the beginning of the system (as far as Ca); thence onwards systematic deviations occur in the sense that the semi-atomic weight increases more rapidly than the atomic number and exhibits a greater and greater difference. As this rule will be of importance in the following section we shall impress it on our minds by means of Fig. 15.

For the sake of economising space we have marked off the atomic numbers (the abscissa) alternately to the right and to the left after

every twenty steps, so that the first branch of the line corresponds to the elements from H to Ca, the second to those from Ca to Zr, and so forth. The ordinates represent for the one part the atomic numbers themselves (continuous line), for the other part half the atomic weights (crosses). We see that the latter, in the mean, increase to the same extent as the atomic numbers, but that with the exception of the lowest branch they lie above the corresponding points of the atomic numbers, the difference increasing as the atomic number increases. Thus our diagram gives us a picture of the above-mentioned complicated relationship between atomic weight and atomic number.

Concerning the arrangement of the periodic system in our table, it cannot fail to be recognised that it is in many ways arbitrary. We have already pointed out the arbitrary nature of the eight columns into which we could insert the great periods only by force, as it were. A further arbitrary adjustment consists in having placed the eighth column on the right, next to the seventh column. As is often done, we may place it as the 0th column in front of the first on the left. The 0th column would then contain the elements of "valency zero," that is the chemically inert gases (at the same time, however, it would contain the triads, which have in a certain sense a high valency, unless we renounce the grouping of the triads and inert gases in one column; but then this grouping seems very plausible, inasmuch as the one row fits so well into the gaps of the other and thus completes the whole structure of the periodic system). By some physicists the inert gases have been placed into the middle column of the table; this has the advantage that electropositive elements are on the right and electronegative elements link up on the left. As is self-evident from the cyclic character of the system, the table may be split at any vertical row and then joined at the former edges.

To dispose of this arbitrariness, the table is often imagined written, not on a plane, but on a cylinder (Chancourtois, Lothar Meyer, Harkins),* whereby the secondary relationships within the great periods and the departure of the rare earths from periodicity is exhibited very well by passing from the surface into the interior of the cylinder at appropriate points. Representations in which plane spirals are used have also been suggested. It must be clearly understood that the arbitrariness concerns the type of description but not the essence of the matter. In spite of the manifold nature of the elements, the relations between them follow in logical sequence.

The general doctrine, however, that we derive from our consideration of the natural system is that which we stated at the beginning of this chapter.

The atoms of the various elements are not different by nature but, in virtue of the uniform connexions which exist between them, they must be

* William D. Harkins and R. E. Hall, American Chemical Society, **38** (1916), or *Zeitschr. f. anorgan. Chemie*, **97**, 175 (1916).

similarly constituted and must be built up of identical units. This gives the lie to the name atom, which signifies indivisible. We now seek to penetrate into the interior of the atom.

§ 2. Nuclear Charge and Atomic Number. The Atom as a Planetary System

The absorption of cathode rays and the dependence of the absorption on the velocity suggested to Lenard, as we remarked above (Chap. I, § 3), as early as 1903, that matter has a perforated structure and that only a vanishingly small part of the space occupied by it is impenetrable by rapid cathode rays, whereas the whole remaining space allows them to pass freely. (We shall call this the **Nuclear Theory of Matter**; Lenard called it the *Dynamide Theory*.)

Ten years later Rutherford was led to the same conclusion, expressed in a quantitative form, by experiments on the scattering of α -rays. In passing through thin metal leaves a bundle of α -rays at first undergoes a general scattering, which is distributed in conformity with the laws of chance. Just as the shots from a gun at a target, so the points of impact of α -particles cluster about a mean position of greatest probability, the elongation of the incident beam of α -particles, and occur less and less frequently in all other directions as we move outwards from this mean position. A fluorescent screen, such as is used in spinthariscopes, allows us to observe the impact of individual particles owing to the scintillation produced. But there are occasional departures from the incident direction, which amount to as much as 150° , and which seem contrary to the laws of chance. They are few in number (e.g. in the case when platinum is the scattering leaf and α -rays from radium C are used for the scattered radiation, they amount to 1 in 8000 of the incident particles), but this number is much greater than is to be expected according to the law of scatter-

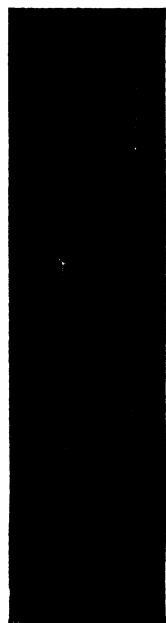

FIG. 16.

ing for small angles. Rutherford* and his collaborators, Geiger and Marsden,† made an accurate investigation of the distribution of these abnormal deflections among the various angular segments for a series of metal laminæ, using α -rays of various velocities. We have met with corresponding abnormal deflections in Wilson's photographs, in the form of hooks at the end of the paths of the α -rays produced, not by atoms of metal, but by air molecules. We reproduce in Fig. 16 the picture of a particularly striking case (this is an enlargement of a portion of our former picture, Fig. 3b).

* Phil. Mag., 21, 669 (1911).

† *Ibid.*, 25, 604 (1913).

What has happened to the α -particle at this bend? Rutherford traces the effect back to very intense electric fields that start out from a very small element of space, the "nucleus." Since the magnitude of the abnormal deflections increases with the atomic weight of the deflecting element, the intensity of the deflecting field must also increase with the atomic weight. If we consider the field produced by a point-charge concentrated in the nucleus, and if we suppose this charge to act according to Coulomb's law, we can calculate the magnitude of the charge that is necessary to account for the observed deflections. At the suggestion of Rutherford, Chadwick* has made very careful measurements of the deflections caused by thin laminae of Pt, Ag, and Cu, and has succeeded in determining with an accuracy which allows an error of about 1 per cent the charges that must be assumed in the corresponding nuclei. He gets the numbers 77.4, 46.3, and 29.3 for Pt, Ag, and Cu respectively, these numbers giving multiples of the elementary charge e . These numbers agree, within the limits of error, with the position of the corresponding element in the periodic system, namely, with the atomic numbers 78, 47, and 29. Thus we follow Rutherford in enunciating the fundamental thesis: *The nuclear charge is equal to the atomic number numerically.* If in the general case we designate the atomic number by Z , then the nuclear charge of each element is Ze , the nuclear number being Z .

The nuclear charge, in itself, might just as well be negative as positive, that is, the deflections might be regarded just as well as due to attractions instead of to repulsions. But our general observations about ions and electrons lead us to decide in favour of the positive sign for the nuclear charges. For the nucleus must possess not only a considerable charge but also a high resistivity, that is, must have a great mass in order to bring about the great deflections of the α -particles. Now it was the positive charge (cf. p. 5) that was, by nature, associated with gravitational matter, whereas the negative charge was a property of the light and mobile electron. Electrons, as centres of negative charges, may be adduced to explain the small deflection in the regular scattering, whereas we must fall back on the heavy positive nucleus to explain the abnormal deflections.

We thus arrive at the following summarised statement. *The positively charged α -particle is repelled by the positively charged nucleus, if it passes exceptionally close to the latter. In the neighbourhood of the nucleus there is an atmosphere of negative charges, electrons, by which the α -particle is attracted.* These attractions, which are superposed according to the laws of chance, explain the regular scattering of slight angular deflection, whilst repulsions explain the comparatively rare bends of great angle.

Observations of α -rays also allow us to make deductions about the

* Phil. Mag., 40, 734 (1920).

size of the nuclei. The distribution of the deflections among various angles was calculated by Rutherford and Chadwick on the assumption that the nuclear charge is concentrated at a point. So far as the observed deflections agree with those calculated, they thus show that the size of the nucleus did not interfere with the paths of the particles. The greatest deflections that have been observed thus give us an upper limit for the possible size of the nucleus. In the case of gold, Darwin* has obtained a value $3 \cdot 10^{-12}$ cms.; in that of water he obtained $2 \cdot 10^{-13}$ cms. This estimate by no means precludes the nucleus from being actually smaller, but it cannot be larger if a disagreement with the observations of α -rays is to be avoided. We may thus at least affirm with certainty that *the nucleus (as also the electron, see p. 12) can be at most of sub-atomic size.*

On the whole, atoms must be electrically neutral. Consequently the number of electrons† per atom must equal the number of elementary positive charges concentrated in the nucleus. Hence we get our second thesis. *The atomic number is equal to the nuclear charge (numerically), and both are equal to the number of electrons around the nucleus.*

This thesis is supported by a result arising from the theory as well as from the measurement of Röntgen radiation: this result is the value found for the amount of scattered radiation per atom. As we saw earlier (Chap. I, § 5, eqn. (13)), this amount led us to conclude that the number of excited electrons per atom that emit scattered radiation is equal to half the atomic weight. Whereas in the case of optical waves only the outside or loosely bound electrons (so called dispersion or valency electrons) are perceptibly excited—the inner electrons are too rigidly fixed to be affected by the optical excitation to which they are exposed—the X-rays which are of high frequency, affect the inner electrons (those nearer the nucleus). The above result about the scattered radiation was interpreted earlier as follows. *The total number of electrons in the atom is approximately equal to half the atomic weight* and is exactly equal to the atomic number of the element; this accords with Fig. 15 of the previous paragraph in which we saw that the atomic number is approximately equal to half the atomic weight.

So far our theses are supported by comparatively meagre observations. In the next chapter the facts given by the X-ray spectra will furnish us with much stronger evidence. Assuming these results for the moment, we affirm: *for each step forward in the periodic system of the elements the*

* C. G. Darwin, Phil. Mag., **27**, 506 (1914); cf. Rutherford, *ibid.*, 494 (1914).

† In more accurate language, we mean the number of electrons present in the atom *outside the nucleus*. For, later, the facts of radioactivity will compel us to assume that there are also electrons in the interior of the nucleus. In determining the nuclear charge these are subtracted from the positive charge present. Hence "nuclear charge" denotes, not the positive charge of the nucleus, but *the algebraic sum of the positive charge of the nuclear matter and the negative charge of the electrons contained in the nucleus*. For further remarks see § 6 of this chapter.

nuclear charge grows by one unit and the nuclear mass becomes increased by approximately two units. For since the electrons contribute only a vanishingly small amount to the atomic weight, the latter must be represented essentially by the mass of the nucleus. And further: each element in the periodic system contains one electron more than the preceding element (we do not here take into consideration the nuclear electrons mentioned in the last foot-note).

The question arises: how can the electrons of the atom maintain themselves in opposition to the attractive action of the nuclear charge? Will this action not cause them to fall into the nucleus? The answer—a possible one which is particularly simple and satisfactory—is furnished by the conditions of the solar system. The earth fails to fall into the sun for the reason that it develops centrifugal forces owing to its motion in its own orbit, and these forces are in equilibrium with the sun's attraction. If we transpose these ideas to our atomic model we arrive at the following view. **The atom is a planetary system in which the planets are electrons. They circulate about the central body, the nucleus.** The atom of which the atomic number is Z is composed of Z planets each charged with a single negative charge, and of a sun charged with Z positive units. The

gravitational attraction, as expressed in Newton's law, is represented by the electrical attraction as given by Coulomb's law; these laws are alike in form. There is a difference in that the planets repel one another in our atomic microcosm—likewise according to Coulomb's law—whereas, in the case of the solar macrocosm they undergo attraction not only from the sun but also from themselves. The fact that the dynamical laws—

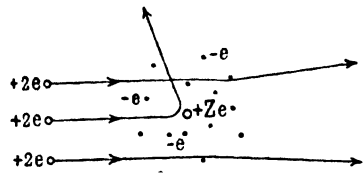

FIG. 17.

we just now introduced them in using the popular expression, centrifugal force—hold in our microcosm just as exactly as in the astronomical macrocosm, will be fully exhibited in all our later discussion.

Bearing in mind the picture of the planetary system, let us once again consider the phenomenon of α -ray deflection. We shoot an α -particle, a comet, through our planetary system. In general it pursues a rectilinear path (as is shown in the top and bottom paths of Fig. 17) and is attracted (scattered) only slightly by the nearest small planets. But if it strikes the sun directly or passes near by (central path of Fig. 17), it undergoes a comparatively great and immediate repulsion. It then describes a hyperbolic orbit, in the focus of which is the nucleus; the angle of deflection is equal to the angle between the two asymptotes of the hyperbola.

This astronomical description of the phenomenon hints, too, at the method of calculation, and Rutherford was the first to apply it in the discussion of the measurements of α -ray deflections and on it he founded

his nuclear theory. The historical remark must be added that van den Broek* was the first clearly to formulate the idea of a nuclear charge increasing with the atomic number and of the electronic number, and he substantiated these ideas with chemical facts.

§ 3. The Simplest Examples of Atomic Models.

1. *The hydrogen atom* (Niels Bohr,† 1913). The simplest atom is the hydrogen atom; for this, $Z = 1$. It consists of a nucleus with one positive charge, and of an electron that revolves about this nucleus. In Fig. 18 we have designated by * the nucleus as the centre of the lines of force. Three circles have been drawn as examples of the path of the revolving electron. The sense of revolution is of course arbitrary, as is also the position of the plane of the orbit in space. It seems at first as if the size of the circles is arbitrary. For we may make the electron run along a circle of any radius whatsoever as long as we give it a velocity such that the centrifugal force due to the revolution exactly balances the attraction

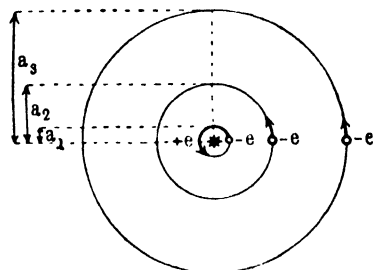

FIG. 18.

due to the nucleus. Nevertheless, we affirm that actually only certain discrete values of the radii of the orbits may occur when the atom is in a stable condition. We indicate this in the figure by marking the radii a_1 , a_2 , a_3 , which are to be regarded as of definite lengths given by a certain law. (This will be discussed in the following section.) At any rate the motion must encounter no resistance if stationary orbits are to be possible; in our

case, this means that *no radiation may take place*.

We observed in Chapter I, § 5, that the accelerated electron radiates energy of an amount depending on its acceleration. Uniform rotation is an accelerated motion (since the direction of the velocity is altering continually, although its magnitude remains unaltered). So that according to classical electrodynamics a rotating electron must also be radiating energy. Hence our atomic models deliberately contradict ordinary electrodynamics, as far as the radiation of energy is concerned.

These two postulates that the orbits be discrete and free from radiation, not only in the case of the hydrogen atom but also in all others, seem at first rather bizarre. But they are quite indispensable and are supported by two fundamental facts: the *discreteness and sharpness of the spectral lines* on the one hand, the *existence and permanence of the atoms* on

* Physik. Zeitschr., 14, 32 (1913).

† The writings of Bohr that laid the foundation to this theory appeared under the title: "On the Constitution of Atoms and Molecules," 1913, in Phil. Mag., 26, 1, 467, 857.

the other. We postpone the discussion of all scruples against these postulates till later when we deal with the ideas of the quantum theory.

In § 6, Chapter I, we sketched one branch of the quantum theory; the general introduction will be given in § 1, Chapter IV. Whereas in Chapter I we limit ourselves to the phenomena of radiation, we shall in the fourth chapter apply the quantum theory to any mechanical motions whatsoever, setting up definite rules according to which certain orbits will possess a unique character among all possible ones. According to the nature of the motion these rules will be concerned with the energy or with the moment of momentum, with the form or with the position of the orbit. In the first case they make the energy, in the second the moment of momentum, and so forth, consist of an integral number of elementary quanta of the corresponding quantity. According as we set this number, which we may call the **quantum number**, equal to 1, 2, 3, . . . , we obtain a discrete series of **quantum paths or orbits**, which thus correspond in turn to the discrete series of whole numbers or integers. The quantum theory asserts that all these quantum orbits are stationary states of motion, that is that they are traversed without radiation being emitted.

In the matter of discrete orbits our planetary system of atomic dimensions differs decidedly from the solar system.* In other respects, however, the analogy may be carried further, as follows. Just as in the solar system the general motion of the electron about the nucleus is an ellipse, at a focus of which the nucleus is situated; but these "Kepler ellipses," further, form a discrete series, the members of which are characterised arithmetically by quite determinate eccentricities and major axes in conformity with quantum conditions. But these are details of the model, the existence of which we shall only be able to demonstrate much later (in the last chapter, when dealing with the hydrogen doublets). For the present it is sufficient to imagine exclusively circular paths as depicted in Fig. 18.

Concerning the appearance of these various circular orbits we may already here remark the following. The innermost orbit (radius a_1 in the figure) is the most stable; as a rule the hydrogen electron is to be found in this orbit. By excitation from without (heat motion, electric fields, collisions) the electron is occasionally removed into one of the outer orbits (radii a_2, a_3, \dots in the figure), which it also traverses as a stationary orbit, but with less stability. When left to itself it falls earlier or later back into the innermost orbit or, more generally, into one that is situated further inside. It is only during these transitions that energy is radiated out, namely the difference of energy in the initial and the final path of the electron.

* In drawing this comparison we feel compelled to mention the well-known rule of Titius Bode, which asserts that the radii of the planetary orbits are approximately connected by a simply arithmetical relation. We decline to regard this as a result of the quantum theory or to compare this rule with our laws which give discrete atomic orbits.

The hydrogen atom is the prototype of all further atomic models, and the whole theory of spectral lines has been developed from it. The reason is easy to grasp. Only in the case of the hydrogen atom are we dealing with the simple case of the *problem of two bodies*; in the case of all other atoms we meet with the notoriously difficult problem of three bodies or more.

2. *The hydrogen ion.* Still simpler than the hydrogen atom we find the hydrogen ion, which bears a single positive charge. It is so simple that we appropriately dispense with a pictorial representation of it. After it has lost its only electron it consists solely of a *solitary nucleus of vanishingly small spatial dimensions as compared with atomic dimensions.*

We might find a connexion between this special constitution of the hydrogen ion and its unusual mobility in electrolysis, and with its activity in acids—we could well do this, were it not that there are several other ions, e.g. the hydroxyl (OH), that likewise possess unusually great mobility, ions which undoubtedly have a more extended constitution. Moreover, it is known that the electrolytic ions are loaded with multiple water molecules (or, more generally, with molecules of the solvent). Hence the real hydrogen ion, as it occurs in electrolytes, is by no means of sub-atomic dimensions but is an extended complex.

On the other hand, another inference that may be drawn from the constitution of the hydrogen ion is well founded: *it is impossible to picture as a physical reality a hydrogen ion carrying two positive charges.* If a chemist should ever succeed in producing such a one, we should be compelled to declare all that follows in this book to be false. In his analysis of canal rays, J. J. Thomson* has actually never found doubly positively charged hydrogen atoms (just as little as trebly positive helium atoms), whereas in the case of mercury positive charges up to eight units occurred (cf. Chap. I, § 3). The impossibility of having a hydrogen atom with a double positive charge is connected with the general difference between positive and negative charges, which was emphasised at the end of Chapter I, § 4: a negative charge may be increased to any extent, a positive charge only to a certain limit, namely, to that at which all electrons have been removed from the atom.

3. **The neutral helium atom.** "*Hier stock' ich schon, wer hilft mir weiter fort,*" says Faust. This atom would have to consist of a doubly charged positive nucleus, the "helium nucleus," four times as heavy as the hydrogen nucleus, and two electrons. But how do the electrons rotate around the nucleus? Here we stumble over the three-body problem.

* Sir J. J. Thomson, *Rays of Positive Electricity*, Longmans, Green & Co., 1921. Thomson emphasises the certainty of this statement by the following words on p. 53 of this book: "No hydrogen atom with more than one charge has ever been observed, though as the hydrogen lines occur practically on every plate more observations have been made on the hydrogen lines than on those of any other element." The non-existence of H^{++} was first proved by W. Nammer, contrary to Sir J. J. Thomson's assertion (Ann. d. Phys., 43, 686, 1914), and was only later taken over by the latter.

Niels Bohr, directly extending his hydrogen model, has suggested for the He-atom the model represented in Fig. 19. Two electrons are to rotate at opposite ends of a diameter about the nucleus on the same circle, and hence at the same speed. Unfortunately, for various reasons, this picture may no longer be regarded as true. It would behave paramagnetically in a magnetic field, whereas real helium is diamagnetic. If we calculate the work that is necessary to detach one of the two electrons, the so-called "**work of ionisation**" or **ionisation potential** (if it is measured in volts), it comes out to be too great (28.8 volts instead of the observed value of 25.4 volts, cf. Chap. VI, § 3). As regards dynamical behaviour, our model is unstable with respect to certain perturbations, and is unable to continue existing when subjected to certain comparatively minor influences, and so forth. It seems rather that, according to the optical behaviour of He gas, as has been observed during ordinary refraction of light, in the real atomic-model of helium one of the two electrons must form a close bond with the nucleus, so that the other electron can circulate around both as in the case of the hydrogen atom. The inner system then acts on the external electron with an "effective nuclear charge" of 1, that is, with the positive excess of charge: $+2 - 1 = +1$. The exact position, however, is still a mystery, which will be solved only when the numerical explanation of the spectra of neutral helium has been found. Obviously, to overcome the extraordinary mathematical difficulties, new methods will have to be thought out. We hope that these are already available in Bohr's newest ideas about atomic structure.*

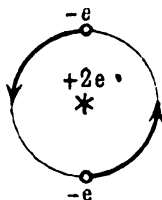

FIG. 19.

4. **The ionised helium atom.** On the other hand, the positively charged helium atom, the He^+ -ion, which has been deprived of one electron through electrical or thermal agency, is very simple. Consisting of a *doubly charged nucleus and one electron*, it is represented by the same picture as the hydrogen atom. Like the latter, it thus also comes under the scheme of the two-body problem.

It differs from the H-atom only in size. It is easy to understand that the two-fold attraction of the He-nucleus on the electron diminishes the orbit of the rotating electron as compared with that of the electron that rotates around the singly charged H-nucleus, and, indeed, it is reduced to one-half the size (cf. the following paragraph). Hence, we may again use Fig. 18 as a picture to represent the He^+ -ion, but we must consider the nuclear charge increased to $2e$, and the radii decreased by one-half.

In the theory of spectral lines ionised helium has become of great importance, and has shown itself superior in some respects to H. The broad outline of the theory has been developed and confirmed by the spectrum of H, whereas the finer details have been suggested and proved by the ionised helium.

* Cf. N. Bohr, in the letter called "Atomic Structure," in Nature, 24th March, 1921.

5. **The α -ray particle.** The next picture, that of doubly ionised helium, the helium atom with two positive elementary charges, is very characteristic and satisfactory. It is, like the simply positive hydrogen ion, a mere nucleus without real extension. The unique part played by this system as an α -particle in radioactive phenomena now becomes clear. The enormous penetrative power of α -particles, their comet-like intrusion into the planetary systems of foreign atoms, their double positive charge, which corresponds to the loss of all electrons in the helium, the non-existence of three-fold positively charged helium, give it a special rôle. In addition, the circumstance that, hitherto, a characteristic light emission of α -rays has never been observed, speaks in favour of our model. In the first chapter we spoke of the luminescence of canal rays and of the similarity of nature between canal rays and α -rays. This similarity, as we now see, cannot extend to the luminescence. We are acquainted with helium canal rays that consist of neutral and also of simply ionised helium atoms. These are recognised, among other methods, by the characteristic lines that they radiate out. To render this emission of spectral lines possible, there must be present at least one electron, which alters its position during the process of emission. But the doubly ionised helium atom is devoid of electrons, and hence of the means of radiating. It becomes immediately obvious that the helium nucleus, in travelling as an α -ray through the atmosphere or other matter with its enormous velocity (almost $\frac{1}{10}$ velocity of light), cannot carry an electron with it on the way or draw one to itself.

It must also be mentioned that already in Fig. 17 we have made use of the exceedingly minute size of the α -particle. When, arguing from this figure, we derived an upper limit for the nuclear size of an atom, deducing it from the deflection of α -ray comets, we assumed tacitly that the α -particles could be justifiably treated as points. In more correct language, this determination of size gave us the sum of the nuclear radii of the atom in question and of the helium atom. Inasmuch as the sum was found to be sub-atomic, it was clear that, besides the atomic nucleus under consideration, the α -particle itself can have no appreciable size.

Whereas scruples may be raised against the later spectral evidence of our atomic theory, on the ground that it requires diverse theoretical intermediate steps, the observable properties of the α -particle follow directly from our fundamental views of nuclear charge and nuclear size, of atomic number, and the number of associated electrons in the atom.

Our picture of the α -particle is so convincing that it seems justifiable to infer from it that there is no gap between hydrogen and helium in the periodic system. In the upper strata of the atmosphere and in stellar nebulae lines have been found that scientists have hitherto not been able to ascribe to known elements, but that seem to hint at elements having an atomic weight of 2 or 3 (Nebulium, Coronium, and Protofluor).*

* Bourget, Fabry, and Buisson, *Compt. rend.*, **158**, 1017 (1914) (Photographs of the nebula of Orion).

existence of elements between hydrogen and helium has been demanded on certain alleged grounds of chemical systematics. (Rydberg concluded that there were two such elements; C. Schmid that there were three.) These inferences, which are quite uncertain in themselves, seem very doubtful in the light of our system of atomic models. If there were two or three new * elements between H and He, then He would not have a nuclear charge 2, but one of 4 or 5. But then the α -particle would not be a mere He-nucleus, but one with two or three outer electrons. But this would be irreconcilable with our general experiences of α -rays. An exact mathematical analysis of α -ray spectra also speaks against an increase of the atomic number Z of all the heavier elements by even a few units, and this would be necessary if unknown elements were inserted at the beginning of the natural system. We shall, therefore, regard it as proved that helium has the atomic number $Z = 2$.

6. **The Li-atom.** It consists of a trebly charged nucleus and of three electrons that rotate around the nucleus in certain orbits unknown to us. Probably one of the electrons is situated at a relatively great distance from the nucleus. We surmise that this is generally true for the alkalis on account of their great atomic volume (cf. § 7 of this chapter); the other two electrons would then form a more intimate bond with the nucleus.

Nor can anything very exact be said about simply ionised lithium. Its orbits, just like those of the neutral helium atom, come into the category of three-body problems. On the other hand, the doubly ionised lithium atom is exactly of the hydrogen type: it is a triply charged nucleus with one electron rotating around it in orbits that are a third as great as those of the hydrogen electron. It would be very well worth while for some one to prepare this doubly ionised helium and to measure out its spectrum. To achieve this, we should have to bombard lithium with the strongest means available (by canal rays). The superiority which we above claimed for He^+ as a test of spectral theory is possessed by Li^{++} to a still greater degree. Without doubt, experimenters will succeed in finding ways and means of realising this state of ionisation of lithium.

Finally, triply ionised lithium is a mere nucleus that gives rise to no spectral phenomena at all.

7. **The atoms of the heavier elements.** As the number of electrons increases so do the difficulties that oppose themselves to the theoretical synthesis of atomic structure. In the case of the N-atom we should have to describe the position and motion of seven electrons, in that of the O-atom eight, and in that of the Uranium-atom we actually have to fit ninety-two electrons into definite positions or orbits.

For the present we shall have to rest satisfied with asking general

* The existence of "isotopes" of H or He of atomic weight 2 or 3 (cf. § 5 of this chapter and also § 6) is not excluded by these remarks.

questions concerning the arrangement of the electrons. Are the electrons subdivided into groups? Do they form rings that surround the nucleus, or shells arranged in space? Do the rings lie in a plane or are they inclined to one another? Or have the shells a symmetrical form? What is the number of innermost electrons in the atom? How many electrons are to be found in the outermost region? We shall see that several of these questions, even at the present stage of our knowledge, will receive a more or less definite answer. Whereas the questions concerning the innermost shells of the atom will be dealt with in the next chapter, which is concerned with the theory of X-rays, the questions about the constitution of the electronic envelope is to be treated in connexion with the natural system of elements, that is, in *this* chapter.

In reviewing the substance of this section we cannot but regret the comparatively scant number of atomic models that have hitherto been established as certain. We feel quite sure about the model of the hydrogen atom and of the very similar atoms, He_4 and Li^+ , of which the latter has not yet been made accessible to experiment. Concerning the neutral He-atom, the atom of Li^+ and the heavier atoms, we have been able to make only provisional and insufficient assumptions.

To the future falls the task of working out *a complete topology of the interior of the atom* and, beyond this, a system of mathematical chemistry, that is, one which will tell us the exact position of the electrons in the atomic envelope and how this qualifies the atom to form molecules and to enter into chemical compounds.

The subject of mathematical physics has been in existence for more than one hundred years; a system of mathematical chemistry that can achieve what we have just mentioned, that can shed light on the still very obscure conception of valency and can, at least in typical cases, predict the reactions that must occur, is only on the point of being created.

§ 4. Auxiliary Mathematical Reflections. Molecular Models

To begin with, we shall supplement quantitatively what we have said about the hydrogen atom.

Let a_1 be the radius of the smallest circular orbit that, according to Bohr, the electron can describe about the *hydrogen nucleus*, or, let a_1 be the radius of the *first Bohr circle* as we shall call it. In addition to this first orbit it can move in the second, third, . . . n^{th} Bohr circle. The radii of the latter are :

$$a_2 = 2^2 \cdot a_1, \quad a_3 = 3^2 \cdot a_1, \quad a_n = n^2 \cdot a_1 \quad . \quad . \quad . \quad (1)$$

We shall use the same terminology as that used in (1) of the preceding section and shall call n the *quantum number* of the circle under consideration. We then, in general, call the n^{th} Bohr circle the n^{th} *quantum orbit*.

In the case of the ionised helium atom, as in that of the doubly ionised lithium atom, and so forth, the corresponding radius is only one-half, one-third, . . . as large as that of hydrogen on account of the double, treble, . . . charge of the nucleus. The proof of this as well as of (1) will be furnished later in Chapter IV, § 3. In general the radius of the n^{th} Bohr circle for a nucleus with a Z -fold charge around which one electron rotates is given by

$$a_n = \frac{n^2 a_1}{Z} \quad (2)$$

For the sake of later applications this formula must be extended in two directions.

(a) Let the nucleus be surrounded by a certain number of electrons, say p ; suppose there is a further electron at a comparatively great distance away. This external electron is to be considered moving in such a way that in a certain circular orbit it is in dynamical equilibrium under the combined influence of the nuclear attraction, the repulsion of the inner electrons and its own centrifugal force. (The same may be assumed for the inner electrons.) Then the force that acts on the outer electron is no longer the whole nuclear charge Ze but the “**effective nuclear charge**” :

$$Ze - pe = Z_{\text{eff}} \cdot e \quad Z_{\text{eff}} = Z - p \quad (3)$$

(b) Further, suppose that in the outer orbit there is not one electron but q , which are distributed at equal distances on their common circular orbit. Then, not only do the p inner electrons act as a screen, but also the q outer electrons, the latter, of course, not with the full electric force corresponding to their total number q but only with a fraction of it, which we shall call s_q . This fraction may be calculated, as we shall presently show, for the general case by an easy method. For the present let the hint suffice that the repulsions which the $q - 1$ electrons exert on the remaining electron combine in pairs to form resultants, which, when continued backwards, pass exactly through the nucleus (cf. in Fig. 20 the resultant PR, which is composed of two equal repulsions PQ₁, PQ₂ that are images of one another in an imaginary mirror along PR). For an even value of q (in the figure, $q = 6$) there is, in addition to the symmetrical pairs of electrons, the one diametrically opposite to the one under discussion, and this one exerts a repulsion along PR. In the case of both odd and even values of q , the total effect of these repulsions

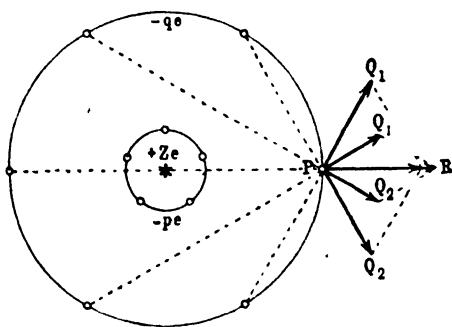

FIG. 20.

are images of one another in an imaginary mirror along PR). For an even value of q (in the figure, $q = 6$) there is, in addition to the symmetrical pairs of electrons, the one diametrically opposite to the one under discussion, and this one exerts a repulsion along PR. In the case of both odd and even values of q , the total effect of these repulsions

can lead to nothing more than a weakening of the nuclear attraction, that is, a further screen-effect that must be added to (3). In place of (3) we thus get the effective nuclear charge

$$Z_{eff} = Z - p - s_q \quad . \quad . \quad . \quad (4)$$

and in place of (2) we get for the radius of the n^{th} Bohr circle, in which our ring of q electrons can circulate,

$$a_n = \frac{n^2 a_1}{Z_{eff}} \quad . \quad . \quad . \quad (5)$$

(c) Our next step is to calculate arithmetically the quantity s_q introduced into (4). Let n be the number of electrons and a the radius of the ring. Each two neighbouring electrons are separated from one another by a distance that subtends the angle $\alpha = \frac{2\pi}{n}$ at the centre. Hence an initial electron P is separated from the $(k + 1)^{\text{th}}$ electron q by an angle

$$k\alpha = \frac{2\pi k}{n} = 2\beta.$$

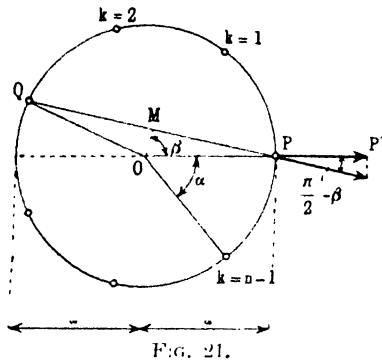

In Fig. 21, the half of this angle, if we use the triangle OPM, allows us to calculate half the distance between

our first and our $(k + 1)^{\text{th}}$ electron, that is to calculate

$$\frac{1}{2} r_{PQ} = a \sin \beta = a \sin \frac{\pi k}{n} \quad . \quad . \quad . \quad (6)$$

According to Coulomb's elementary law, two charges e and e' separated by a distance r act on one another with a force $\frac{ee'}{r^2}$. Accordingly, the force which Q exerts on P in the direction QP is

$$\frac{e^2}{4a^2 \sin^2 \frac{\pi k}{n}} \quad . \quad . \quad . \quad (7)$$

To form the resultant, however, we do not need the whole force but only its component PP' in the direction of OP. This is obtained from (7) by multiplication with

$$\cos \angle MPO = \sin \angle MOP = \sin \beta = \sin \frac{\pi k}{n}$$

and has thus the value

$$\frac{e^2}{4a^2 \sin \frac{\pi k}{n}} \quad . \quad . \quad . \quad (8)$$

The resultant of all the electrical repulsions at P then becomes simply

$$\frac{e^2}{4a^2} \sum_{k=1}^{k=n-1} \frac{1}{\sin \frac{\pi k}{n}} \dots \dots \dots (9)$$

in which the sum is to be taken by beginning with the electron ($k = 1$) succeeding our initial one up to the last electron before the initial one ($k = n - 1$). The quantity

$$s_n = \frac{1}{4} \sum_{k=1}^{k=n-1} \frac{1}{\sin \frac{\pi k}{n}} \dots \dots \dots (10)$$

is that fraction of Coulomb's force $\frac{e^2}{a^2}$ with which the ring electrons act repulsively on a single one of them; thus, the symbol s_n corresponds to that used in equation (4).

We arrive a little more simply still at the same quantity s_n , if we inquire into the potential electrical energy of our electron ring. The Coulomb energy, that is, the useful work contained in the field of two charges e and e' and due to the mutual Coulomb attraction, is

$$\frac{ee'}{r} \dots \dots \dots (11)$$

On account of (6) this gives for our electron ring

$$\frac{e^2}{2a} \sum_k \frac{1}{\sin \frac{\pi k}{n}} = \frac{2e^2}{a} s_n \dots \dots \dots (12)$$

if we write down only those terms in which a definite initial electron plays a part. To arrive at the full potential energy V , we have yet to multiply this expression by n (we may choose each electron of this ring in turn as the "initial" electron), and to halve the value obtained (otherwise we should be reckoning the mutual action between two ring electrons twice over). We thus get

$$V = \frac{e^2}{a} n s_n \dots \dots \dots (13)$$

For $n = 2$, we obviously get from (2)

$$s_2 = \frac{1}{4} \frac{1}{\sin \frac{\pi}{2}} = \frac{1}{4} = 0.25.$$

For $n = 3$, we get

$$s_3 = \frac{1}{4} \left(\frac{1}{\sin \frac{\pi}{3}} + \frac{1}{\sin \frac{2\pi}{3}} \right) = \frac{1}{2} \frac{1}{\sin 60^\circ} = \frac{1}{\sqrt{3}} = 0.577.$$

For $n = 4$, we get

$$s_4 = \frac{1}{4} \left(\frac{1}{\sin \frac{\pi}{4}} + \frac{1}{\sin \frac{\pi}{2}} + \frac{1}{\sin \frac{3\pi}{4}} \right) = \frac{1}{4} (1 + 2\sqrt{2}) = 0.957.$$

For higher values of n we use trigonometrical tables. In this way we get

TABLE 3

$n = 1$	$s_n = 0.0$	$n = 9$	$s_n = 3.328$
$= 2$	$= 0.25$	$= 10$	$= 3.868$
$= 3$	$= 0.577$	$= 11$	$= 4.416$
$= 4$	$= 0.957$	$= 12$	$= 4.984$
$= 5$	$= 1.377$	$= 13$	$= 5.565$
$= 6$	$= 1.828$	$= 14$	$= 6.159$
$= 7$	$= 2.305$	$= 15$	$= 6.764$
$= 8$	$= 2.805$	$= 16$	$= 7.379$

For great values of n , direct calculation becomes cumbersome. In this case we may use the following approximation formula, the results of

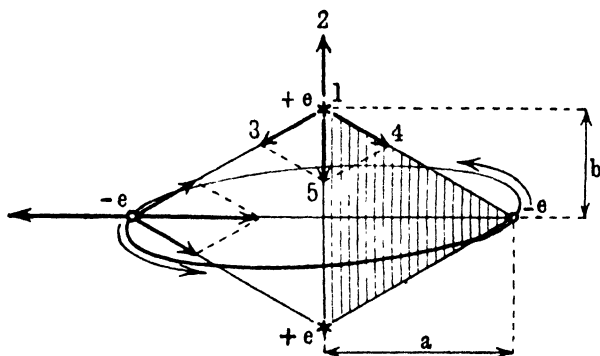

FIG. 22.

which agree well with even the last values in the table and which is useful for forming general estimates :

$$s_n = \frac{n}{2\pi} (\log_e n + 0.12) \quad . \quad . \quad . \quad (14)$$

(It is derived in an essay by the author by means of substituting for the sum an integral, see Ann. d. Phys., 53, 511 (1917).) The formula shows that s_n increases to infinite values with n .

(d) The hydrogen molecule. We shall now describe a little more fully the model that Bohr has suggested for the constitution of the hydrogen molecule H₂, although, nowadays, we can take only a historical interest in it. It is certain that the hydrogen molecule must consist of two hydrogen nuclei; each composed of one positive charge + e , and two electrons, each having the charge - e . Is there an arrangement in which these four charges are in dynamical equilibrium with one another?

The answer is given in Fig. 22. The two nuclei form the axis of the

molecule and are at rest. The two electrons rotate diametrically opposite one another in the plane bisecting the line connecting the nuclei about this line as axis. Let a be the radius of the electron circle, b the distance of the nuclei from the middle plane. We must first determine the ratio $a : b$. The nuclei are subject only to electrical forces. According to Coulomb's law we have, for example, a repulsion at the upper nucleus, due to the lower nucleus, of magnitude

$$\frac{e^2}{4b^2} \quad \dots \quad (15)$$

and two attractions, due to the electrons, of magnitude

$$\frac{e^2}{a^2 + b^2} \quad \dots \quad (16)$$

These three forces acting on the nucleus must be in equilibrium. In the figure they are represented by the arrows 12, 13, 14. Equilibrium certainly comes about if the forces are equal in magnitude and act at equal angles. If they are equal in magnitude we get from (15) and (16)

$$a^2 + b^2 = 4b^2, \quad a = b\sqrt{3} \quad \dots \quad (17)$$

If they are equally inclined to one another then the two nuclei and each electron in turn form an equilateral triangle. In Fig. 22 one of these two triangles is distinguished by being shaded.

Through the relation (17) the equilibrium of the forces is established as far as the nuclei are concerned. What is the position as far as the equilibrium of forces on the electrons is concerned?

We see at once that this equilibrium can be brought about by suitably choosing the rate of rotation. If there were no or only a very small velocity of rotation both electrons would be drawn inwards owing to the attraction of the nuclei: in the case of very great velocities of rotation the centrifugal forces would become predominant and drive the electron outwards, so to speak. It is easy to determine by formula that magnitude of the velocity of rotation for which the centrifugal forces are in equilibrium with the electrical forces.

The electrical attraction which each electron experiences from both nuclei is, as in (16),

$$\frac{e^2}{a^2 + b^2}$$

The resultant of both falls in the direction of the orbital radius a and has the magnitude

$$\frac{2e^2}{a^2 + b^2} \frac{a}{\sqrt{a^2 + b^2}} = \frac{3\sqrt{3}e^2}{4a^2} \text{ (by (17))} \quad \dots \quad (18)$$

Then there is to be added the electrical repulsion of the other electron,

which also acts in the direction of the radius a , but in the reverse direction to that given by (18). Its magnitude is

$$-\frac{1}{4} \frac{e^2}{a^2} \quad (19)$$

Let the angular velocity of the electrons be ω , and hence the linear velocity $a\omega$. The centrifugal inertial force, which arises in this rotation, amounts to

$$ma\omega^2 \quad (20)$$

The forces (18), (19), (20) are to be in equilibrium. This requires that

$$ma\omega^2 = \frac{3\sqrt{3}}{4} \frac{1}{a^2} e^2 \quad (21)$$

Equation (17) determines the form of the hydrogen molecule, equation (21) the velocity of its electrons. There is still wanting a third equation that determines the size of the model. This missing equation can be furnished only by the quantum theory. Bohr applies it to each of the two electrons in the molecule just as to the single electron in the hydrogen atom (cf. Chap. IV). This would complete the molecular model.

But is it correct? Only a short while ago, even while this book was in its first edition, we were inclined to accept it. Particularly after Debye* had calculated the refraction of light in a gas composed of such models and had found it to agree with the empirical behaviour of hydrogen gas. Since then, however, a series of properties have been remarked, in which the model departs from reality in its behaviour, above all, in its magnetic behaviour (it is paramagnetic in the model, diamagnetic in reality); also in the instability of the model when subjected to certain small disturbances; further, the decrease of the specific heat corresponding to the rotational degrees of freedom at low temperatures, to explain which we must assume a smaller moment of inertia than that possessed by the model; finally, the magnitude of the ionisation voltage and the heat of dissociation, that is, the amounts of work respectively that are necessary to detach an electron and to separate the two nuclei from one another come out somewhat differently when calculated for the model from what has been observed. These objections, as we see, coincide partly with those which, in paragraph 3 of the previous section, we were obliged to raise against Bohr's He-model. Thus the true model of the H_2 -molecule is still unknown. It will hardly be as symmetrically built as the model exhibited in Fig. 22. On account of the magnetic properties the two electrons cannot rotate in the same sense but must do so in opposite directions.

For the oxygen and the nitrogen molecule the author has proposed models that were formed along the lines of Bohr's model of the hydrogen molecule. These, too, seemed at first to be satisfactory as far as the phenomena of the refraction of light are concerned, but on closer examination

* Münchener Akademie, 1915, p. 1.

they withstand criticism even less than the hydrogen model, especially because, in this case, the number of outer electrons rotating in the same direction (four in the case of O_2 , six in that of N_2) are greater than in the former case. For a particular reason we add in § 6, Fig. 23, a picture of this model of oxygen (which is rejected later). In the last section of this chapter we shall return to the suggestions of cube models that have come from another quarter.

(e) The positive H_2 -ion. The problem is here simpler than in the case of the H_2 -molecule, because the orbit of only one electron requires to be determined: without involving an undue error we may disregard the counter motion of the nuclei. A dynamically possible type of orbit for the electron suggests itself at once: a circular orbit in the plane at right angles to and bisecting the line connecting the nuclei. The size of this circle will again be determined by the quantum theory; according to the particular quantum number n , there will be a first, second, . . . n^{th} circle. We add details in note 14 at the end of the book.

Again, however, the question arises whether this model gives a true picture of the hydrogen ion. Definite empirical criteria have so far not been available. We must therefore rest our decision on a theoretical consideration of the stability of the model. In this direction calculations by W. Pauli* show that the circular orbit of minimum radius is, indeed, more stable than any other form of motion, for example, than motion in those orbits that lie, not in the median plane, but in a meridian plane through both nuclei. For it may be proved that the transition from the smallest circular orbit to any other type of orbit requires a positive addition of energy; thus the electron cannot spontaneously leave this orbit unless excited from without. The state of motion ascribed to the electron thus seems to represent the state in the natural configuration of the ion. The fact that we call this configuration only *metastable* and not stable is due to the circumstance that the dissociated state (H^+ , H) is still more stable from the energetic standpoint. Further details on this are to be found in note 14.

All in all, the final result in the case of molecular models seems to be even more unfavourable than in that of atomic models. Here we can assert nothing even in the simplest case of the H_2 -molecule. The H_2 -ion was successfully constructed theoretically, it is true, but owing to a lack of empirical evidence, has not been confirmed.

§ 5. The Laws of Radioactive Displacement and the Theory of Isotopes

The characteristic properties of the α -particle (its double charge, its great penetrative power, and so forth) have already served us as a direct and obvious confirmation of our fundamental views, namely, those of Rutherford, Bohr, and van den Broek, on nuclei, nuclear charge, and atomic

* Zeitschr. f. Phys., 1921.

number (cf. §§ 3, 5). Radioactivity, however, can furnish us with still more information on this question.

Let us consider the genealogical tree of the radium family in Table 1 of p. 47, and discuss the position of Ra itself. Since it was first inserted into the table there has been no doubt that it belonged to the group of alkaline earths Ca, Sr, Ba. In particular, Ra is so closely related to Ba chemically that, originally, it was difficult to separate them from one another; the similarity in the spectra of the two is also perfect. On the other hand, radium emanation, in virtue of its chemically inert behaviour, beyond doubt belongs to the group of inert gases. It occupies the space left for the last element of the sixth period (in our representation of the table), which was vacant before its discovery, just as Ra filled in a gap in the seventh period, occupying the second space of it after the gap of eka-caesium.

Now, *this mutual position of Ra and RaEm in the periodic system is just such as is demanded by our nuclear theory.* Ra disintegrates, producing RaEm and emitting α -radiation. The doubly charged positive α -particles comes out of the nucleus of the Ra-atom and thus diminishes its positive charge by two units, $2e$. Hence the atomic number of the resulting element must also be reduced by two, that is, the newly produced element must precede the Ra in the system of elements by *two places*. The nuclear mass becomes reduced simultaneously with the nuclear charge, namely, by four units corresponding to the atomic weight of He. According to Hönigschmid the atomic weight of Ra is 226.0. Hence, in the scheme of p. 57 the atomic weight $226 - 4 = 222$ has been ascribed to the emanation; it has been surrounded by brackets because it is not a result of direct measurement. But as far as measurement was possible it did not conflict with this deduction for, from the determination of the density of the very small amount of emanation available and on the assumption that it is monatomic, the result obtained was 223 ± 4 (the roughness of the approximation is obvious under these circumstances).

We generalise the remark just made about Ra and RaEm and enunciate the *first law of radioactive displacement thus.* *In every process of radioactive disintegration which is accompanied by the emission of α -rays (α -transformation) a product results, the atomic number of which in the periodic system is reduced by two units; the element moves two places to the left in the table. At the same time its atomic weight decreases by four units.*

Now what happens in the case of β -transformations, that is, of those radioactive processes during which β -rays are omitted? Does the β -ray electron in this case come out of the electronic shell of the element or out of its nucleus? In the former case, the character of the element and its position in the periodic system would remain unaltered. We should have before us a process to which the term ionisation would have to be applied. The element would become positively charged to the extent of one unit, but would retain its chemical properties. But we know that β -trans-

formations also cause new elements to be formed. Hence the β -emission, like the α -emission must come out of the nucleus.

We must assume (this will be discussed in detail in the following section) that in a nucleus of atomic number Z there must be in addition to the Z positive unit charges that determine this atomic number, further positive and negative charges which are mutually bound and which neutralise one another (cf. also the note on p. 64). Now if a negative unit charge (an electron) is thrown out of this neutral stock of charges, a positive unit of charge is free, that is, unbalanced by a negative charge. But then the nuclear charge must increase by one unit. Hence we get the second law of radioactive displacement. In the case of β -transformations, the atomic number of the element undergoing change increases by one unit, and moves to the next position on the right in the periodic table. The diminution in the atomic weight in this process, however, is inappreciable on account of the small mass of the electron.

In fact, the atomic weight does not become reduced at all if we take into account the fact that the atom which, owing to the β -transformation, has become positive, will soon neutralise itself by drawing to itself a free electron from without. Such free electrons, so we may assume, are always available in the interior of a metal and in an atmosphere continually subject to radioactive radiations and hence ionised. Of course, the external electron just mentioned does not enter into the nucleus but into the electronic shell. In this way it makes the number of electrons that is properly due to the new element derived by the β -transformation complete. Hence the charging process of the β -transformation is followed by a process of neutralisation. The small diminution of atomic weight that is initially caused by the loss of the β -electron is thus rectified again.

After the α -transformation, too, a process of neutralisation will also take place. For the atom which has arisen through the α -emission will at first have two electrons more than the number corresponding to its nuclear charge. It will therefore give up two of its electrons to its surroundings, not, of course, in the form of β -radiation, but by way of balancing its charge without the generation of considerable kinetic energy. The decrease of atomic weight to the extent of four units, which corresponds to the α -emission, thus becomes slightly more marked owing to this additional loss.

It is of historical interest to note that Fajans* and Soddy† share about equally the honour of having discovered these laws of displacement.‡ Soddy first enunciated the law of displacement for α -transformations. Fajans tested it on further material and added the law of displacement for β -transformations. He and, a little later, Soddy formulated

* Habilitationsschrift Karlsruhe, 1912; Physik. Zeitschr., 14, 181 and 186 (1913).

† Die Chemie der Radioelemente, Leipzig, 1912 (English, 1911); Chem. News, Vol. 107, p. 97 (1913).

‡ The general law was being sought almost simultaneously by A. S. Russell (cf. Chem. News, Vol. 107, p. 52), but his formulation was not quite correct.

TABLE 4

At. Wgt.	I	II	III	IV	V	VI	VII	VIII	At. Wgt.
197	Au								197
200		Hg							200
204			Tl						204
206			β AcC''	RaG, AcI)					206
207				Pb					207
208			β ThC''	ThD	Bi				208
210			β RaC''	β RaD, β AcB	β RaE, $\alpha\beta$ AcC	α Po, α AcC'			210
212				β ThB	$\alpha\beta$ ThC	α ThC'			212
214				β RaB	$\alpha\beta$ RaC	α RaC', α AcA			214
216						α ThA			216
218						α RaA		α Ac-Em	218
220								α Th-Em	220
222		α AcX						α Ra-Em	222
224		α ThX							224
226		α Ra	β Ac	α RdAc					226
228		β MsTh ₁	β MsTh ₂	α RdTh					228
230				α Io, β Uy	α Pa				230
232				α Th					232
234				β UX ₁	β UX ₂	$\alpha\alpha$ U ₁₁			234
238						α U ₁			238

both laws of displacement in the form which is now generally accepted as valid.

In our account we have read the laws of displacement directly out of the theory of nuclear structure. Historically, the state of affairs was of course different. When these laws were first enunciated this nuclear theory did not exist nor was it possible at that time to arrange the radioactive products into the groups of the periodic system in all cases. It was rather the laws of displacement that have led to the present arrangement of the radioactive elements into the scheme, and at the same time they have given the theory of nuclear charges a sound foundation.

Table 4 shows on the one hand the distribution of the radio-elements in the periodic system, on the other, in the vertical columns, their distribution in the scale of atomic weights. The character of the radiation emitted is, as in the former table on p. 47, indicated by the letters α , β prefixed to the symbol of the element under consideration.

Let us, for example, follow out the radium family, beginning with Ra and proceeding with the zig-zag step prescribed by the laws of displacement. We get from Ra (Column II, At. Wgt. 226) to RaEm (Column VIII, At. Wgt. 222), to RaA (Column VI, At. Wgt. 218), to RaB (Column IV, At. Wgt. 214) by successive α -transformations. Next, from RaB we get by a β -transformation to RaC (Column V, At. Wgt. 214). At RaC the interesting branching that was discussed earlier (on p. 48) takes place: by an α -transformation we get to RaC' (Column III, At. Wgt. 210) and then by a β -transformation to the long-lived RaD (Column IV, At. Wgt. 210); on the other hand, from RaC by a β -transformation to RaC'' (Column VI, At. Wgt. 214); to this transformation we owe the emission of intense γ -rays by RaC; then by an α -transformation we likewise get to RaD. From RaD a two-fold β -transformation leads to RaE (Column V) and RaF (= Polonium, Column VI) in which the atomic weight 210 is retained. The position of polonium in the periodic system may, according to Marckwald, be verified by chemical methods. It is more electronegative than Bi (in the sense elucidated in § 1, p. 56) and this conforms with the position which has been assigned to it, namely that immediately succeeding Bi. A final α -transformation changes polonium into RaG, also called radium lead (Column IV, At. Wgt. 206), which is less than the atomic weight of ordinary lead, 207.2. Radium lead is the final product of the radium series. As far as we know, the thorium and the actinium series also end at the same point of the periodic system, at thorium lead (ThD) and actinium lead (AcD).

It may be left to the reader to go through the parallel transformations of thorium and actinium in the table, so that we need now consider only the beginnings of the radium series from uranium downwards, whereby the origin of the actinium series will become clear, as already exhibited in Table 1 of the radioactive tree of descent (Chap. I, § 7).

The parent substance is U_1 (Column VI, At. Wgt. 238); by an α -

transformation UX_1 (Column IV, At. Wgt. 234) is produced; by a two-fold β -radiation we get UX_2 and the long-lived U_{II} at the same position as U_I (At. Wgt. 234). By an α -transformation there is produced from U_{II} the long-lived Io (Column IV) and, by a further α -transformation, radium (Column II). Investigations (cf. p. 46) by Hahn and Meitner, however, established with certainty that actinium, too, must ultimately come from uranium, and their researches make it seem probable that the branching of the actinium series takes place at U_{II} , which, owing to an α -transformation, changes not only into the long-lived ionium but also into the short-lived UY ; both products are in Column IV (At. Wgt. 230). The occurrence of two different α -transformations at the same element U_{II} with a different final result (Io and UY), that is, a "branching due to α -radiation alone," has never been observed in any other instance. It is assumed that the UY becomes transformed through a β -transformation into the parent substance of actinium, known as protactinium (Column V, At. Wgt. 230). Since Ac is produced from the latter by an emission of α -radiation, it belongs to Column III, as has been long known: its atomic weight, 226, is the same as that of radium.

We must next refer to the interesting complex of facts, to which the name **isotopes** is applied collectively. Isotope signifies "occupying the same position;" isotopes are elements that occupy the same position in the periodic system. The totality of isotope elements in one compartment of the system is called a *pleiad*. The pleiads of lead and polonium include no less than eight and seven members respectively. The individual members differ among themselves in atomic weight up to as many as eight units, but are yet so similar that, in some quarters, their character of being distinct elements is disallowed. *For isotopic elements cannot be separated from one another by chemical means at all and exhibit identical physical properties throughout.* The only means of separating them chemically or physically is that offered by the difference in the atomic weights which may manifest itself in a difference in their gravitational and inertial action.

The most convincing confirmation has been found for the theory of isotopes in the case of lead. When the atomic weights of lead isotopes of varying origin were compared with one another, it was shown that lead from radium minerals (RaG) has the atomic weight 206.0 and lead from the thorium minerals has the atomic weight 207.9, whereas ordinary lead has an atomic weight 207.2.

On account of the interposition of isotopes the traditional framework of the periodic system must be extended. Since there are now several claimants to one space of the system, the scheme on one plane no longer gives a non-ambiguous (uniform) allocation of the elements. It is best to extend the scheme spatially. We imagine the isotopes to be placed behind one another in order of their longevity, say. The longest-lived element forms the chief representative of the pleiad in question and would stand furthest back in our spatial scheme, in the same vertical plane as

the permanent elements which are not suspected of being radioactive. From this longest-lived element the series of isotopes of varying longevity would then be successfully arrayed outwards and upwards perpendicular to the plane scheme. Thus in the two-dimensional table of elements, we should, to be more accurate, have to place in the lowest space below uranium U_I , whereas the isotope U_{II} would have to be placed in front of it (out in space). In the last place but one, protactinium stands as the longest-lived element of its type (its stretch of life is at least 12,000 years), whereas the element UX_2 (also called brevium) that has hitherto been installed there has a life of only 1.15 minutes and would thus have to be brought forward out of the table. Of the three emanations Ra-Em is the longest lived (3.85 days) and must therefore stand as the representative of the inert gases in the sixth period. In the former table the chief representatives of the corresponding type of elements was emphasised by being printed in dark type. We maintain rigorously that the remaining isotopes are also true elements. They are distinguished from one another by their origin, their later developments, and their radioactive manifestations. Theoretically, we should be able to separate them from one another by diffusion in the gaseous state, by using centrifugal and similar methods in which the mass of the element is involved, provided that sufficient quantities were available and that the mode of measurement was sufficiently accurate. But for the ordinary methods of analytical chemistry, a mixture of isotopes would behave as a uniform element.

Through the discovery of isotopes *atomic weight has been displaced from its position of sovereignty by the nuclear charge*. We are acquainted with elements, for example, RaG and RaB, or Po and RaA, which differ in atomic weight by eight units and yet (as isotopes) they behave identically alike in chemical reactions. On the other hand, we know elements, for example, RaD and Po that behave chemically as differently as C and O, which belong, namely, to the fourth and sixth column of the periodic system, and yet they have the same atomic weight. Pairs of elements of the latter type are to be found in Table 4 in a horizontal line; pairs of elements of the former type occur vertically. Thus atomic weight is, within certain limits, of no account so far as the chemical character of the element is concerned. On the other hand, the nuclear charge determines uniquely the chemical character in that from within outwards it regulates the arrangement of the electrons in our models up to the outer boundary of the electronic atmosphere, the region of chemical valency.

Not only among decaying elements but also among permanent elements there are isotopes. Nor do they occur as exceptions; indeed, they are the rule. Of the elements that have hitherto been investigated for signs of isotopy just about as many have shown themselves to be multiform as uniform. Those that have been proved to be uniform, that is of a single kind, are

H	He	C	N	F	O	P	S	As	J
1·008	4·00	12·00	14·01	19·0	16·00	31·04	32·06	74·96	126·92

and the multiple ones are

Li	B	Ne	Mg	Si	Cl	A	Br	Kr	X	Hg
6·9	11·0	20·2	24·3	28·3	35·46	39·88	79·92	82·92	130·2	200·6

We see that the atomic weights that have been printed below the symbols for the elements are in the case of the simple (uniform) elements, in particular, of the lighter ones—almost exactly whole numbers; on the other hand, they diverge considerably from integers in the case of elements that have been recognised as multiform. Further, the elementary constituents into which the latter may be resolved, are here, as we shall see, exactly whole numbers, within the limits of error.

We are indebted for this important knowledge to the work* of F. W. Aston, who, for his part, added a new link to the analysis of canal rays ("positive rays") carried out by J. J. Thomson (cf. p. 14). In the canal-ray tube there are manifold fragments of matter, simply and multiply charged, atom-ions and mol-ions. In an electrical field they are deflected by a force proportional to their charge and inversely proportional to their mass. Hence in the case of two isotopes of the same charge and different mass the heavier constituent will be less deflected than the lighter. Furthermore, the amount of the deflection depends on the velocity that has been acquired by particle in question. The advantage of Aston's method over Thomson's was gained by connecting up behind the electrical field a magnetic field, the intensity and direction of which was so chosen that all particles of the same mass are concentrated at one and the same spot: The photographs so obtained are called "mass-spectrograms."

The first result of Aston states: Neon consists of two isotopes of atomic weight 20·00 and 22·00, "neon" and "meta-neon." The atomic weight obtained by chemical means, 20·2, results from a mixture of both in a constant proportion.

The resolution of chlorine into two isotopes of atomic weight 35·0 and 37·0 (in addition to which there are also indications of one of at. wgt. 39) is particularly impressive. The chemical atomic weight of chlorine, 35·46, which among the lighter elements is the first serious contradiction to the integral (whole number) character of the atomic weight, comes about owing to the fact that, as is shown from the photographic plate, the Cl_{35} is present in greater quantity than the Cl_{37} ; the proportion is 3 : 1. In addition to the spots of 35 and 37 we see in the mass-spectrogram of the Cl-photographs, also the spots 36 and 38 present in about equal proportions: these are to be interpreted as HCl_{35} and HCl_{37} . Then, again, there are spots 17·5 and 18·5 that represent doubly charged Cl_{35} and Cl_{37} . (In a spectrogram double the charge acts like half the mass.)

* Phil. Mag., 39, 449 and 611 (1920). See also *Isotopes*, F. W. Aston, 1922, Edward Arnold & Co., London.

§ 5. Laws of Radioactive Displacement and Theory of Isotopes 87

In the case of the neutral gases krypton and xenon, not less than six and five isotopes, respectively, have been disclosed, of which the atomic weights differ up to 8 in the case of Kr, and 7 in that of X. Thus we have here pleiads as manifold as those occurring among the radio-elements (cf. Table 4). The same is true of the not yet fully resolved pleiad of mercury. Further details are given in the following scheme, in which the bracketed numbers denote suggested or uncertain cases :

Li	B	Ne	Mg	Si	Cl	A	Br	Kr	X	Hg
6	10	20	24	28	35	36	79	78	(128)	197-200
7	11	(21)	25	29	37	40	81	80	129	202
		22	26	(30)	(39)			82	(130)	204
								83	131	
								84	132	
								86	134	
									136	

We restrict ourselves to these few data here and must refrain from reproducing Aston's spectrograms (which can be seen in his book *Isotopes*) or describing them in detail. On the other hand, an optical spectrogram (band-spectra of HCl) will later serve us as a striking document of the double nature of chlorine (cf. Chap. VII).

At present only atoms in the gaseous state may be treated by Aston's method; this explains the comparatively small number of elements that have hitherto been examined for signs of isotopic character. Mg has been investigated by A. J. Dempster* by a canal-ray method differing from that of Aston; in this case the three isotopes are present in the approximate proportion 6 : 1 : 1.

In view of all these discoveries the traditional term "atomic weight" is no longer properly appropriate to express the quantity with which the chemist is familiar. The true atomic weights of the simple constituents are whole or nearly whole numbers. The usual atomic weights which in many instances vary from integral values should rather be called "mixture-weights." The constant values of the latter must be interpreted as showing that the isotopes of the mixture came into existence before the earth's crust had solidified, in epochs in which their uniform commingling was possible and inevitable. This alone would explain why the chemist everywhere and at all times finds them occurring in the same proportions.

The striking characteristic of elementary atomic weights, that of being integral, restores *Prout's hypothesis* to its position of honour: according to this hypothesis, all atoms are supposed to be built up of hydrogen—of hydrogen nuclei and electrons, as we may nowadays say, or else (cf. p. 22) of "positive and negative electrons." The fact that hydrogen itself is simple—in spite of the slight departure of its atomic weight, 1.008 from unity—has been proved not only by Aston but also by Stern and Volmer† by another method (fractionated diffusion of hydrogen and oxygen).

* *Phys. Rev.*, **11**, 316 (1918), and **17**, 427 (1921). † *Ann. d. Phys.*, **59**, 225 (1919).

If, in accordance with the sense of Prout's hypothesis, H-nuclei are the real elementary "bricks" of which all gravitational matter is built up, it must cause surprise that in the radioactive transformations "H-rays" have never been observed. Why does not the hydrogen nucleus occur as a decay product of the higher elements just as well as the less simple He-nucleus? According to what law of displacement would such an "H-transformation" take place? Since the H-nucleus is endowed with a simple positive charge and since it has the atomic weight 1, the law must clearly be: *Displacement in the periodic system by one unit to the left and simultaneously a decrease of the atomic weight by one unit.* Actually, such H-transformations have never been observed among the spontaneous radioactive processes, however much they may have been sought. We might, with Fajans, see a vague indication of it in the circumstance that hydrogen so often occurs locked up in the rare earths. There is a type of artificial radioactive decay which is familiar as producing H-rays, namely Rutherford's disintegration of nitrogen. We shall speak of this in the next paragraph.

Finally, let us consider the regularity in the succession of the atomic weights from the point of view of the displacement laws. We saw in the first paragraph of this chapter that, corresponding to the even atomic numbers $Z = 2n$, there occur particularly frequently atomic weights of the form $4n$; corresponding to the odd atomic numbers $Z = 2n + 1$, there are those of the form $4n + 3$. This occurs in a particularly striking manner in the region between C and Ca. Here we get, if we separate the natural order into an even and an odd series of atomic numbers and atomic weights:

TABLE 5

	$n =$	3	4	5	6	7	8	9	10
Even series	$Z = 2n$	6	8	10	12	14	16	18	20
	At. wgt. = $4n$	12	16	20	24	28	32	36	40
Odd series	$Z = 2n + 1$	7	9	11	13	15	17	19	
	At. wgt. = $4n + 3$	14*	19	23	27	31	35	39	

In writing down this table we have made use of Aston's results; that is, whenever various isotopes existed, we chose the atomic weight that fits into our scheme; for example, in the case of A we chose 36 (not 40). In looking at these series it is difficult to avoid the impression that we are here dealing with *two series of α -transformations*, each of which independently obeys the displacement law for α -transformations (regular decrease of the atomic number by 2, and of the atomic weight by 4, in passing from right to left). The only exception is to be found at the point $Z = 7$, which has been marked by an asterisk, namely the case of nitrogen where

we should expect an atomic weight of 15 in place of 14. This exception is of particular interest in connexion with the artificial disintegration of nitrogen just mentioned. But another observation occurs to us as we look at Table 5. Our two series may possibly be connected together by an *H-transformation* of such a kind that the two series branch out from a parent substance, the series of atomic weight $4n$ arising by a succession of α -transformations, the series $4n - 1$ by a single H-transformation and then a succession of α -transformations.

It is hardly necessary to emphasise that in this speculation we are, at present at any rate, leaving the firm ground of fact, and that in the case of the elements here under discussion, no trace can be shown of either an H-transformation or even any spontaneous decay at all. Nevertheless such reflections are at the present time inevitable. The proof of the fact that there are isotopes among non-radioactive substances is a direct challenge to us to seek out genetic relationships in the periodic system, and to extend the laws of displacement to the whole system.* This fact makes it seem highly probable that the nuclei, too, are of a composite nature and may be synthesised. This opens up a new chapter in the annals of research, about which we must now say a few words, namely *nuclear physics*.

§ 6. Observations on Nuclear Physics

There is no doubt that the radioactive nuclei contain helium nuclei and electrons, which they emit as α - and β -rays. Prout's hypothesis and its confirmation in Aston's experiments requires beyond this that all nuclei of atoms be ultimately composed of H-nuclei and electrons ("positive and negative electrons"). In the case of He-nuclei this necessarily leads to the assumption that they are composed of H-nuclei that are connected by two electrons. (We shall illustrate in a figure below how this is to be pictured.)

In general we may assert that a nucleus of atomic weight A and atomic number Z will contain altogether

$$K = A - Z \quad . \quad . \quad . \quad . \quad . \quad (1)$$

electrons. For A (which, with Aston, we assume to be a whole number) denotes the number of hydrogen nuclei and, at the same time, the total number of positive charges; Z gives as the nuclear charge the uncompensated positive charge that acts outwards. The difference of these two must be compensated by nuclear electrons.

Of these nuclear electrons a large proportion is in the form of He-nuclei. For atoms of weight $A = 4n$, $Z = 2n$ (cf. p. 88) we have, according to the experiments of Rutherford discussed below, to assume that they consist of n He-nuclei. In this case, we get, by (1), $K = 2n$, which is not greater than is necessary to bind the n He-nuclei together.

* Cf. van den Broek, *Physik. Zeitschr.*, **22**, 164 (1921).

At the same time, $\frac{A}{2} = Z$ in this case. The excess Δ of the semi-atomic weight over the atomic number, which we recorded and studied in Fig. 15, shows in each case the presence of nuclear electrons that are not contained as He-nuclei.

We proceed to prove this generally, not only for atomic weights of the form $4n$, but also for those of the form $4n + a$ ($a = 1, 2, \text{ or } 3$). Let x be the number of He-nuclei, y and z the number of electrons and H-nuclei respectively that are not combined together into He-nuclei. We then clearly have

$$A = 4x + z$$

$$Z = 2x + z - y$$

thus

$$\Delta = \frac{A}{2} - Z = y - \frac{z}{2}$$

i.e.

$$y = \Delta + \frac{z}{2}.$$

The number of electrons y that are not included in the He-nuclei is thus at least equal to the excess Δ , which is illustrated in Fig. 15. According to this figure the number y increases systematically with the atomic number.

We shall now follow L. Meitner* and assume that nuclear electrons that are not included in helium nuclei, may in part be attached to them. Thus, in addition to doubly charged helium nuclei, there will also be helium nuclei that are neutralised by association with two electrons. We shall call the first, as usual, α -particles, and the neutralising electrons, on account of their presently-to-be-shown connexion with β -rays, β -particles; finally, we shall call the helium nuclei, to which these β -particles attach themselves, α' -particles, so that a neutralised helium configuration of this type receives the name " $(\alpha' + 2\beta)$ -particle." In addition to isolated H-nuclei and further electrons, we thus also reckon as nuclear constituents

α -particles and $(\alpha' + 2\beta)$ -particles.

The radioactive branches of descent (p. 47) teach us that these ideas are no mere fictions.

For, at the very beginning of the uranium series there is the succession $\alpha - \beta - \beta$. We shall assume that this α -radiation in the case of U I is an α' -radiation, that is, that it is derived from a neutralised helium configuration. When this configuration is deprived of an α' -particle, the two β -particles also become free; this is why two β -transformations follow the emission of the α' -particle. The same phenomenon occurs at the beginning of the thorium series.

But how will the configuration $(\alpha' + 2\beta)$ behave when its decay begins with, not an α -radiation but a β -radiation? Two ways are then

* Zeitschr. f. Phys., 4, 146 (1921).

open. Either the second electron of the group follows with a β -radiation, and then the α' -particle; or else the α' -particle is emitted first and followed by the second β -particle. The typical branching of the radioactive trees of descent at the points occupied by C-products show that both ways are followed, although not equally often (measured by the percentage ratio of branching). That both ways must lead to the same final result is theoretically clear, even if it has not been proved experimentally: for the result finally is that the whole group ($\alpha' + 2\beta$) is detached. Whereas, in the thorium and actinium series the final result of branching represents simultaneously the end of the whole tree of descent, in the case of the radium series the decay-sequence $\beta - \beta - \alpha$ still follows. In this case, too, we have the characteristic phenomenon of two β -radiations occurring conjointly with an α -radiation (α' -radiation). We should be inclined to expect a branching at this point, too, that is, in addition to $\beta - \beta - \alpha'$, also $\beta - \alpha' - \beta$. There is nothing to stop us from assuming that the ratio of branching is vanishingly small for the second of these ways, and so has escaped notice up till now.

Finally, the repeated succession of α -radiations that occur, for example, between UIII and RaB can easily be accounted for. Such radiations are, of course, not α' -radiations, but are to be regarded as α -radiations in the narrower sense used above. The number of the α -particles in the nucleus is much greater than that of the α' -particles; as a matter of fact, the comparatively small value of Δ shows that most nuclear electrons are built into α -particles, and that, relatively, only a few are used in the formation of α' -particles. It is thus more probable that an α -radiation should be succeeded by further such radiations, in view of the predominating number of α -particles, than that an α' -particle or one of the β -particles interlocked with it should become loosened.

Concerning further consequences, e.g. the branching of the actinium series at UY, we must refer to the work of L. Meitner quoted above. Our object here was only to show that speculations on the structure of nuclei are already suggested by the well-known facts of the radioactive tree of descent.

These speculations have now entered on an entirely new stage, since Rutherford * succeeded in 1919 in splitting up by artificial means nuclei of lighter elements, as exemplified at present, in the nucleus of nitrogen. This was the first occasion on which H-nuclei were proved to be elementary constituents of the nucleus, and became accessible to measurement.

Rutherford worked with α -rays of RaC. Their velocity is $2 \cdot 10^9$ cms. per sec.; their range is 7 cms., that is, in air at atmospheric pressure they excite scintillations in a fluorescent screen (of ZnS) at distances up to 7 cms., but not at greater distances. Such α -rays represent the most powerful concentration of energy at our disposal. When they strike hydrogen molecules or bodies containing hydrogen, they set free H-nuclei

* Phil. Mag., 37, 537, 562, 571, 581 (1919).

as high-speed "H-rays." This happens, certainly, only when the He-nucleus exactly hits the H-nucleus or passes in very close proximity to it. The range of these secondary H-rays is, corresponding to their smaller mass, greater than that of primary α -rays; namely, it is 28 cms. in air. They can thus be easily distinguished from the former by means of a fluorescent screen.

But H-rays can be proved to be present not only in gases containing hydrogen but also in air free from water vapour. In pure nitrogen considerably more scintillations occur than in a mixture of nitrogen and oxygen. From this it was inferred that *the H-rays arise from the nitrogen nucleus*. Magnetic deflection also led to the correct value of $\frac{e}{m_H}$. In this way the artificial transformation of an atom was achieved for the first time and a dream of the alchemists attained realisation.

Rutherford succeeded in shattering, besides nitrogen, the following atoms by means of α -rays of RaC':

B, F, Na, Al, P.

Here, too, the scintillation method was used as a proof. In the case of the following elements, the result remained uncertain:

Li, Be, Mg, Si, Cl, K.

Rays of long range were found to be missing with certainty in the case of:

C	O	S	Ca	Ti	Mn	Cu	Su
12	16	32	40	48	56	63.6	118.7.

The figures below the last row of elements show that we are here dealing with atomic weights of the form $4n$ essentially. As at the beginning of this section we may assume that such elements are composed only of He-nuclei and that they contain no free H-nuclei. Rutherford therefore comes to the conclusion that only elements of atomic weight

$$4n + a \text{ where } a = 1, 2, 3$$

may become disintegrated by losing H-rays. The emission of whole He-nuclei would be demonstrated by our present means only if they possessed a greater range than that of the primary rays: in fact, all mass-rays of less range would be beyond observation. We shall give reasons below in support of the view that the He-nuclei in their turn are not shattered—neither the impinging He-nuclei nor those built into the atom that is struck.

In the case of Al and P the observations of the scintillations disclosed surprisingly great ranges: for Al the range was at least 80 cms.! If, as is to be presumed, we are here dealing with H-rays, their initial energy in this case would be 28 per cent greater than the energy of the exciting α -rays. (If the carrier were of greater mass, this energy would obviously be still greater.)

In view of these facts we cannot regard the shattering of the atom other than as *radioactivity that has been set going by forcible means*. In spite of the great energy of the impinging α -rays, it does not suffice to account for the energy of the secondary mass-ray. At least a fraction of this energy comes from the shattered nucleus itself. The action of the impinging energy is essentially to loosen and to excite the constituents of the nucleus.

What becomes of the shattered atom in each case cannot yet be determined with certainty. It is surmised that N gives off two H-nuclei and becomes transformed into C.

In addition to H-rays, Rutherford believed that he would have to assume the presence of He-rays in the case of scintillations that corresponded to a distance of 9 cms. Their behaviour in a magnetic field led him to conclude that they were He-nuclei with a charge 2 and a mass 3, that is, an isotope of helium. Recently, however, Rutherford has come to the conclusion that this inference is not inevitable.

It is easy to understand why only rather light nuclei can be artificially disintegrated. In the case of greater nuclear charges the approaching α -particles lose too much speed to be effective. They run themselves to a standstill in the field of the nuclear charge. Let us work this out for the case of Pb, in which $Z = 82$. The work done by the electric repulsion which the charge $82e$ exerts on the charge $2e$ of the α -particle when the latter approaches from infinity to within a distance a , is :

$$\frac{2 \cdot 82 \cdot e^2}{a} \quad \dots \quad (3)$$

(e is measured in E.S. units). The initial energy of the α -particle is for $v = 2 \cdot 10^9$ cms. per sec. = $\frac{2}{30}c$:

$$\frac{1}{2}m_{\text{H}}v^2 = 2m_{\text{H}}\left(\frac{2}{30}\right)^2c^2 \quad \dots \quad (4)$$

The velocity will have been reduced to zero when

$$2m_{\text{H}}\left(\frac{2}{30}\right)^2c^2 = \frac{2 \cdot 82e^2}{a}, \text{ i.e. } a = \frac{82 \cdot e_{\text{max}}^2}{\left(\frac{2}{30}\right)^2 m_{\text{H}}} \quad \dots \quad (5)$$

Here $e_{\text{max}} = \frac{e}{c} = 1.59 \cdot 10^{-20}$ and $\frac{e_{\text{max}}^2}{m_{\text{H}}} = 9649$ (cf p. 5). Hence

$$a = 2.9 \cdot 10^{12} \text{ cms.}$$

If the radius of the Pb-nucleus is smaller than this value, the α -particle will reverse its direction before getting to the periphery of the nucleus. If the radius is greater than this, the α -particle will be able to penetrate into the Pb-nucleus, but only with considerably reduced velocity. Hence it is unlikely that α -rays will be able to shatter heavy atomic nuclei. Even in the case of the lighter elements this reduction of the initial

velocity of the α -rays is to be taken into account. Our inference, earlier, that the energy of the mass-rays observed by Rutherford do not arise from the impinging projectile but from the struck nucleus, holds *a fortiori* in view of this reduction of velocity.

The above calculation at the same time gives us a lower limit for the nuclear radius of the substance emitting the α -rays. RaC is an isotope of Bismuth, for which $Z = 83$. If the α -particle leaves the periphery of its parent nucleus with zero velocity and if it owes its velocity only to the repulsion of this nucleus, the process by which its velocity increases from the value zero up to the value v , which it attains at infinitely great distances, will be described exactly by equation (5), in which a now signifies the radius of the parent substance (the difference between 82 and 83 is clearly of no account for the accuracy of the calculation). Hence we conclude that the nuclear radius of RaC is *at least* equal to $2.9 \cdot 10^{-12}$ cms. If it were less the velocity of the α -rays of RaC would have to be greater than $2 \cdot 10^9$ cms. per sec. If it is greater, we need only assume that the α -particle of the periphery of the nucleus starts out with a certain initial velocity. It is worth noticing that the lower limit thus obtained for the size of the nucleus agrees fairly well with that mentioned on page 56, which was derived empirically.

There is a further possibility that we must not lose sight of, namely, that in heavy atoms there may be, in addition to He-nuclei, still other groups of positive and negative electrons that are more closely inter-related among themselves than with the other constituents of the nucleus. As yet, there is no empirical evidence in support of this. Only the He-group of four H^+ and two electrons has been shown with certainty by the general laws of radioactive decay to be a generally present element of nuclear structure. We have now to deal with the latter in greater detail.

That the He-nuclei cannot be pure point-charges but must contain negative charges, too, seems clear when we consider how often atomic weights of the form $4n$ occur, in so far as we imagine these built up of n He-nuclei and held together by electrical forces. If they were pure positive charges, they would have to repel one another throughout. Only the presence of negative charges inside the He-nuclei renders it possible for several He-nuclei to be so interlocked that the attractive action between the positive and the negative parts preponderates and keeps the whole together.

The atomic weight of He appears to contradict the view that it is composed of four H-nuclei. According to the most accurate measurements, the atomic weight of H is 1.0077; that of He is 4.00 (the data fluctuate between 3.99 and 4.002). Hence when these four H-nuclei combine to form He, they must suffer a loss in mass, which, calculated for the gramme-atom, is given by

$$\Delta m = 4 \cdot 1.0077 - 4.00 = 0.03 \quad . \quad . \quad . \quad (6)$$

As a means of comparison we mention the datum that the heat of combination in usual chemical processes is of the order 100 major cal. In the proportion of these two figures our He-nuclear compound is more stable than ordinary chemical compounds. Whereas in the case of the latter, thermal motion in many instances leads to a splitting up of the compounds, in the case of our nuclear compound not even the energy of the most rapid α -rays suffices to achieve this.

From these noteworthy general considerations which require no particular form for the constitution of the nucleus but only the trustworthy "Principle of the Inertia of Energy," we see that the stability of the He-nucleus is firmly established and that it seems impossible to explode this nucleus into four H-nuclei by the means at present available. Applied to Rutherford's experiments these reflections mean that not only the bombarded He-units but also the impinging α -particles are very stable. Of course, our conclusion of stability is restricted to the assumption that

the He-nucleus dissociates directly into four H-nuclei. In the event of only a partial disintegration, e.g. splitting off of one H-nucleus, nothing can be asserted about the energy of the resultant remaining product, and therefore no statement about stability can be made.

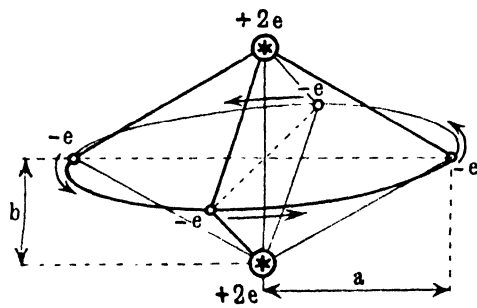

FIG. 23.

If, as Aston's experiments seem to indicate, all higher

atomic weights will ultimately come out as whole numbers, this would lead us to conclude that in the further construction of He-nuclei, H-nuclei, etc., no nuclear reactions occur that could compare with the He-nucleus in closeness of union. Otherwise departures from the rule of integral numbers would have to become perceptible in the case of higher atomic weights also. In this connexion we may regard it as a particularly fortunate circumstance that in chemistry the atomic weights are referred not to H = 1 but to O = 16. With H = 1 the rule of whole numbers would be entirely obscured.

Finally, we wish, without committing ourselves, to try to form a model of the possible construction of the He-nucleus from H-nuclei. In doing so we follow a suggestion of W. Lenz,* which we illustrate in Fig. 23. As a development from Bohr's model of the H_2 -molecule, this represents in the first place a model of the O_2 -molecule that was formerly suggested by the

* Münchener Akademie, 1918, p. 355. In this paper the above relativistic-energetic reasoning for the stability of the He-nucleus is developed; it applies independently of the special model. Similar views were put forward earlier by Harkins and Wilson, Zeitschr. f. anorgan. Chem., 95, 1 (1916).

author: four electrons $-e$ are to move uniformly in a circle around the line connecting the two remnants of the oxygen atom (not atomic nuclei). Since each oxygen atom has lost two electrons from the equatorial electron ring of the model, it acts outwards in both cases with the charge $+2e$, as indicated in the figure. It was pointed out earlier (p. 79) that this model does not, according to our modern view, correctly represent the constitution of the O_2 -molecule.

Lenz calls his model of the He-nucleus an "inverted oxygen molecule." This has the following sense. When, in Fig. 23, the four negative electrons are replaced by four positive H-nuclei, and the two positive atomic remnants are replaced by two negative electrons, a configuration results, which has the mass $4m_H$ and the nuclear charge $(4 - 2)e = +2e$, as is to be demanded of a model for an He-nucleus. Just as little as in the case of the O_2 -model do we know, *a priori*, whether this conforms with reality and can only prove it by experimental tests. In the case of the He-nucleus the following data, admittedly rather unconvincing, present themselves:—

1. The distribution of H-rays that are generated in hydrogen gas by α -particles is very different from that which we should expect if the α -particles acted as point-charges. Indeed, Rutherford says: *The observed effects are of such a kind as would arise if, for example, the helium nucleus consisted of a charged disc of approximately the radius $3 \cdot 10^{-13}$ cms., which in the α -rays sets itself perpendicular to the direction of motion.* Now, our model with the four H-nuclei circulating in one plane actually bears a certain resemblance to a charged disc.

2. If we apply the same laws of the quantum theory, which served to fix numerically the size of the atomic models, to our He-nuclear model, we get for the radius of the H-nuclei an order of magnitude which is smaller in the ratio $\frac{m}{m_H}$ (that is, to the extent 1 : 2000) than the radius of the H-atom. Thus, in this way, we arrive at sub-atomic dimensions for the He-nucleus; certainly these are still considerably greater, according to Rutherford, than is estimated from the observations.

3. In addition to this insufficient agreement in size there is, as Lenz has remarked, an insufficient stability of the model. Even hard X-rays should suffice to disintegrate the model. To escape both these objections Lenz suggests that we should no longer regard Coulomb's law as valid in such concentrated fields of force as must exist in the interior of nuclei.

In Chapter IV we shall develop the laws of the quantum theory and shall apply it in particular to the model of the hydrogen atom. There we shall refer once again briefly to the model of the He-nucleus and the determination of its size. We feel impelled to express the conviction here that the construction of nuclei out of elementary constituents very probably takes place according to the same principles as underlie the

construction of atoms out of nuclei and electrons, namely, according to the rules of the quantum theory.

§ 7. Peripheral and Central Properties of the Atom. Visible and X-ray Spectra. Configurations of the Inert Gases

In the representation of the periodic system given in the first paragraph we followed the example of Mendeleef essentially, both in the setting out of the table as in giving valency the predominant position as the regulative principle for the various groups of elements. The great periods of eighteen to thirty-two elements were thereby inserted somewhat

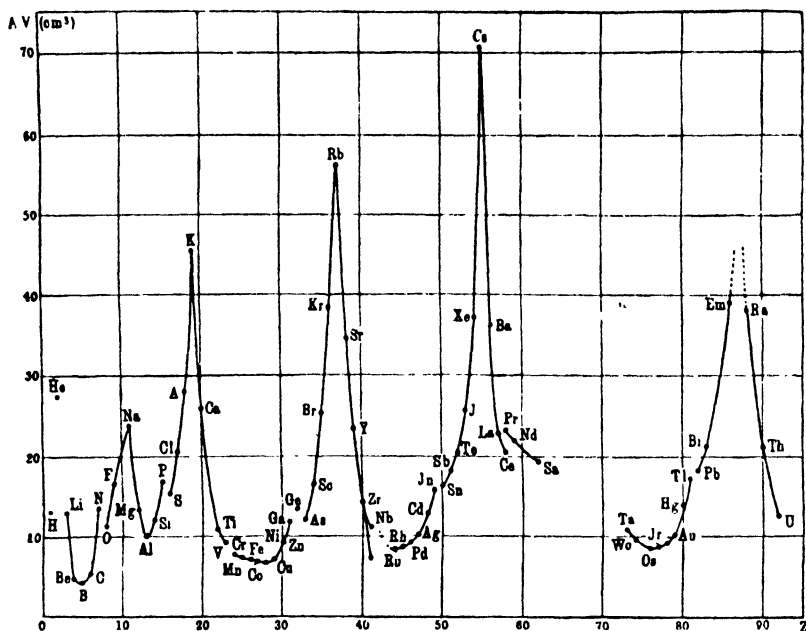

FIG. 24.

forcibly into the rows of eight given by the smaller periods. It remains now to develop the representation that Lothar Meyer gave the periodic system at the same time as Mendeleef. Its crowning feat is the classical curve of atomic volumes, which, since the date when it was made known, 1870, has excited the astonishment and interest of chemists and physicists alike.

As we know, atomic volume denotes the ratio

$$\frac{\text{atomic weight}}{\text{density}}$$

This ratio has the dimensions of a volume (cm^3); it denotes, however, not the volume of one atom, but of so many atoms as are contained

in the number of grammes given by the atomic weight. Instead of atomic volume we might say more correctly gramme-atom volume. We shall, however, retain the term that has been sanctioned by usage.

The atomic volume is, of course, defined only for the solid and liquid state. The gaseous state admits of no proper volume that is characteristic of a substance (unless we calculate such a volume from van der Waal's gas equation). In the case of the so-called permanent gases we must, therefore, in defining the atomic volume, derive the density from the liquefied state. In the case of solids that occur in various allotropic modifications (diamond, graphite), we get several values. We exhibit Table 6 set up by Stefan Meyer* for the atomic volumes ("At. Vol."). We plot the values of this table as ordinates in Fig. 24.

As abscissæ we naturally use nowadays in place of the atomic weights the atomic numbers, which smooth out several irregularities of the curve (for example, at Se and Te).

We call attention to the following prominent features of the curve: the steep maxima at the points occupied by the alkalis, the immediately following descending branches of the curve, the flat minimum in the middle of the period, the ascending branches before the next successive alkali, the likewise high ordinates of the points occupied by the inert gases, and particularly the similarity of appearance between the great periods of 18, 18, and 32 elements with the small periods of 8 and again

TABLE 6

Z = 1	H	13.2	Z = 11	Na	23.7	Z = 21	Sc	—
2	He	27.4	12	Mg	13.4	22	Ti	10.7
3	Li	13.0	13	Al	10.0	23	V	9.27
4	Be	4.72	14	Si	12.1	24	Cr	7.76
5	B	4.4	15	P	{17.0	25	Mn	7.43
6	C	{ 5.4	16	S	{13.5	26	Fe	7.10
		{ 3.42	17	Cl	15.5	27	Co	6.86
7	N	13.6	18	Ar	20.6	28	Ni	6.67
8	O	11.22	19	K	28.0	29	Cu	7.12
9	F	16.7	20	Ca	45.5	30	Zn	9.21
10	No	—			25.9			
Z = 31	Ga	11.8	Z = 41	Nb	{11.1	Z = 51	Sb	18.1
32	Ge	13.3	42	Mo	{ 7.36	52	Te	20.4
33	As	12.1	43	?	10.7	53	J	25.7
34	Se	16.5	44	Ru	8.29	54	Xe	37
35	Br	25.4	45	Rh	8.50	55	Cs	70.6
36	Kr	38.4	46	Pd	9.28	56	Ba	36.2
37	Rb	56.25	47	Ag	10.3	57	La	22.6
38	Sr	34.5	48	Cd	13.6	58	Ce	20.6
39	Y	23.4	49	In	15.9	59	Pr	21.7
40	Zr	14.2	50	Sn	16.3	60	Nd	20.7
Z = 62	Sa	19.3	Z = 78	Pt	9.12	Z = 83	Bi	21.2
73	Ta	10.93	79	Au	10.2	86	Em	39
74	Wo	9.63	80	Hg	13.95	88	Ra	38
76	Os	8.49	81	Tl	17.2	90	Th	21.1
77	Ir	8.62	82	Pb	18.3	92	U	12.74

* Elster and Geitel-Festschrift, Braunschweig, 1915, p. 152.

8 members; this similarity is such that in this representation of the periodic system there is no sign of a subdivision of the great periods into two small periods.

Later, a series of other properties were discovered which exhibited an analogous behaviour in their mode of dependence on the atomic weight (or atomic number, respectively). In Fig. 25 we exhibit as examples of such properties: the compressibility κ , the coefficient of expansion α , the reciprocal of the melting-point $\frac{1}{T}$ (as an inverse measure of the tendency of the element in question to be a solid); these are properties that concern not the filling of space itself as in the case of the atomic volume, but the alteration of the volume occupied owing to pressure and temperature

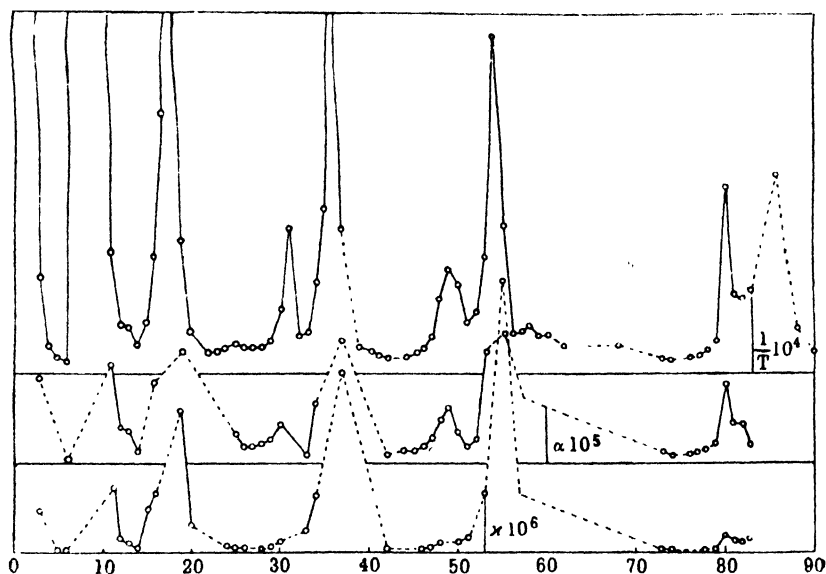

FIG. 25.

changes. In a broad sense, these curves run parallel to those of the atomic volumes, but they seem a little less regular. In the curve of the reciprocal melting-points, the maxima are not at the alkalis but, as is easy to understand, at the inert gases, which show the least inclination towards becoming solids.

All these things concern a pronounced external property of the atom, namely its claim on space. Its connexion with valency conditions and the structure of the periodic system in Lothar Meyer's curve shows that *chemical actions, too, depend on external properties of the atom.* In actual fact, they regulate the external relations of atoms to one another and depend on the number and arrangement of the external electrons that determine the valency. Also the elastic and cohesive properties of atoms,

their thermal behaviour as shown by Dulong and Petit's law of specific heats, the electrical conductivity, and the magnetic permeability give a picture analogous to that given by atomic volumes, and thereby prove that they too are *external properties of the atom*.

But also the phenomena that give rise to the emission of visible spectra occur at the periphery of the atom. The spectra of the alkalis exhibit an essentially similar structure in spite of their greatly different atomic numbers, $Z = 3, 11, 19, 37, 55$, and the consequent increase in complexity of the interior atomic structure. Only the peripheral arrangement of electrons in the series of alkalis is similar; but this suffices to bring about an essential similarity in their visible spectra. The same correspondence exists between the spectra of the alkaline earths Mg, Ca, Sr, Ba, as well as between Zn, Cd, Hg. Almost in every case the *position of the element in its period* and not its position in the system as a whole, its atomic number, is the decisive factor. The latter (atomic number) gives only a slight sign of itself, in that the spectral lines are in general not simple lines but consist of two or three lines that belong together and are more or less close together in the spectrum. The differences between the frequencies of this "doublet" and "triplet" increase regularly with the atomic weight, as used to be stated, or, as we now say, with the atomic number or nuclear charge. But the part played by the nuclear charge in the optical spectra is but a minor one.

This is different in the case of *X-ray spectra*. For this, the atomic number is the chief factor, in that from the atomic number of the element the corresponding X-ray line and, conversely, from the X-ray spectrum the atomic number could be determined uniquely. The frequency of a definite X-ray line, for example, the principle line of the κ -series (cf. the next chapter, § 4), increases uniformly and continuously with the atomic number throughout the whole system of elements without showing a trace of periodicity. In this case it is not the position of the element within the period of the system but its *position in the system as a whole that is the all-important factor*.

Now, what does it signify that in X-ray spectra the atomic number of the element, its nuclear charge, exhibits itself so strikingly, whereas in the spectra of the visible region it hides itself? This signifies that *the region in which the X-ray spectrum takes its origin is the innermost part of the atom, the immediate vicinity of the nucleus, and that, on the other hand, at the periphery of the atom, where the optical spectra are produced, the nuclear charge is screened off by the cloud of inner electrons or just shines faintly through them*. It is owing to the fact that the X-ray spectra take their origin from the central region near the nucleus, where the forces are strongest and least weakened, that their penetrative power and hardness is so great. In contrast with this, the visible spectra require for their excitation only small amounts of energy, compared with the extraordinary amounts that are available in the interior of the atom and that are

necessary to excite X-rays. At the surface of the atom the events occur on a moderate scale but in the interior of the atom they become exaggerated to an extreme degree.

The nucleus and the innermost regions of the atom around it are not built up periodically but, in view of the intensity of the fields of force, their structure is a continuous growth in conformity with the continuous increase of the atomic number. The X-ray spectra reflect this systematic increase of growth and thereby lose all connexion with the periodic structure of the natural system. *Periodicity is an external, and not an internal, property of atomic structure.*

A general inference about the arrangement of the electrons about the nucleus may be drawn from observations concerning isotopes. *Two isotopes of an element cannot be separated by chemical means* (e.g. radium and mesothorium, thorium and radiothorium, neon and metaneon, or Cl_{35} and Cl_{37}); that is, the peripheral parts of their atoms are built up similarly, since it is these parts that are of account in chemical reactions. Moreover, *two isotopic elements have similar spectra* in the visible and the ultra-violet regions* (for example, thorium and ionium or mixtures of the two): this similarity also leads us to conclude with great certainty that the arrangement of the external elements is the same. But two isotopic elements have also the same X-ray spectra (e.g. in the case of lead and RaCr, according to Siegbahn and Stenström: hence they are also alike in the arrangement of the internal electrons. Hence the whole atomic structure is determined uniquely by the nuclear charge; given the same nuclear charge we get the same atomic structure, in spite of varying atomic weights; this applies, in particular, to the radioactive elements. As the decay continues and the nuclear charge alters, the new arrangement of the electrons that corresponds to the new nuclear charge is effected automatically. *Although we do not know the atomic structure in detail, we know the law by which it is governed, the law that is dictated by the nuclear charge through the agency of electrical attractions and repulsions. The atomic structure is uniformly regulated by electrical agency from within outwards as far as the periphery of the atom by the magnitude of the nuclear charge.*

The question as to how the electrons are distributed numerically among the individual shells of the atom is more difficult to answer. The X-ray spectra do, indeed, furnish us with the evidence in which the definite answer will be found, but we are not yet in a position to interpret these data completely. The next chapter will give us further clues. Here we shall just speak of the information that we get from the periodic system of elements for the outermost shell of the atom.

*In the case of the line $\lambda = 4058\text{\AA}$ of lead, differences between uranium lead thorium lead, and ordinary lead have been observed by Harkins and Aronberg on the one hand, and Merton on the other (cf. *Nature*, **104**, 406 (1919)). But they amount to only a millionth of the whole value.

We picture to ourselves the progressive synthesis of the atoms in the order of the periodic system. At each step a new electron is added. In general the new electron attaches itself to the outside, as we may assume that in the interior of the atom there is no room for the immigration of additional electrons. As the number of external electrons increases, step by step, a limit is reached which, for reasons of stability, cannot be exceeded. From that point onwards a new outer shell begins to form, the previous outermost shell contracting inwards. To picture this, we need only remember the rings of a tree in its yearly growth.

The alkalis are decidedly univalent and electropositive. There can be no doubt that we must assign to them in each period *one* outer electron in the outermost shell. The alkaline earths are divalent, the earths are trivalent; to these must be ascribed, respectively, one, two, and three outer electrons (valency-electrons). In general we ascribe to the electropositive atoms at the beginning of each period just as many outer electrons as is expressed by their valency with respect to oxygen (cf. p. 56). *Electropositive character denotes readiness to part with electrons. Electronegative character denotes readiness to take up electrons* ("electron-hunger"). The electronegative atoms lack just as many electrons as they have hydrogen-valency; fluorine wants one, oxygen two, nitrogen three. These electrons are not wanting in them for electrical neutralisation but for electro-mechanical stabilisation.

Between the electropositive elements following the end of a period and the electronegative elements preceding it there is situated in each case an inert gas. When the electropositive elements give up their valency-electrons, *they reduce their configuration to that of inert gases*; whereas when the electronegative elements satisfy their valencies by taking up electrons, *they complete themselves as configurations of the inert gases*. Thus both parties strive towards this goal. Hence we must assume that the configuration of inert gases possesses a special degree of stability, and we see why in the progressive synthesis of the atoms in the natural system each period ends with an inert gas and that then a new shell begins. To avoid misunderstanding, we must, however, emphasise that we only assert the stability of the configuration of the inert gases as a chemical fact but cannot yet give reasons for it.

The two small periods each contain eight elements. The inert gases neon and argon that stand at the end of these periods are thus entitled to eight electrons in the outer shell. Bohr gives good reasons (cf. the end of this section) for thinking that the other inert gases, also, as far as the emanation are to be credited with eight outer electrons. Instead of *configuration of inert gases* we might just as well say "8-shell." Helium with its two outer electrons is, of course, an exception.

The union of electropositive and electronegative elements denotes in the simplest cases the creation of one or more 8-shells. We call to mind HF , H_2O , N_2 . Fluorine, by taking from H the electron that it lacks,

completes itself as an 8-shell; in the same way, oxygen and nitrogen do likewise by depriving two or three hydrogen atoms of their electrons. In all cases the result is the neon configuration with attached hydrogen nuclei. How these nuclei lie with respect to the neon shell, whether, for example, in the case of water they are arranged diametrically and symmetrically, whether they have definite positions at all, is still open to discussion. Further, in the formation of NaCl two full 8-shells come about: the outer electron of Na emigrates to Cl; Cl becomes raised to the argon type, and Na becomes lowered to the neon type. The ions Na^+ and Cl^- , on the formation and electrical attraction of which the compound NaCl doubtless depends, both have in their external configuration the character of inert gases. They are distinguished from Ne and A only by a ± 1 difference in the nuclear charge. The same holds for all alkali halogen salts and for univalent polar compounds. In the case of divalent polar compounds two electrons emigrate from the electro-positive to the electronegative component. In this way there result, for example, in the case of CaO two 8-shells, the one, Ca^{++} , being of the argon type, the other, O^- , being of the neon type.

W. Kossel,* by reviving Berzelius' theory, has worked out fully this view of chemical action and has tested it in Werner's complex compounds in addition to the typical simple polar compounds. He arrives at the result that in all compounds that are given as forming ions or that are built up analogously to ion-forming compounds, the atoms are present as ions in the undissociated state also. Consequently the single forces represented in the old chemical scheme by hyphens with their mystic directions become replaced by the physically more intelligible electric forces of the ions. Of course, on this view we cannot account for homœopolar† combinations, that is, combinations in which ions cannot be assumed, as, for example, those of di-atomic gases: the difficulty of understanding the latter presented itself to us sufficiently clearly in § 4 in the case of the simplest homœopolar problem, that of the H_2 -molecule. But apart from this the successes achieved by the electrical scheme are astonishing. It would take us much too far from our true object to offer even only a sketch of it.

Almost at the same time as Kossel, G. N. Lewis‡ recognised the part played by the configuration type of inert gases as the goal of chemical reactions, and pictured them in the special form of a cube, in the eight corners of which the electrons of the 8-shell are stationed. The same picture was sketched out a second time by Born and Landé,§ being

* In his long paper: *Über Molekülbildung als Frage des Atombaus*, Ann. d. Phys., **49**, 229 (1916). Cf. also: *Über die physikalische Natur der Valenzkräfte*, Naturwiss., **7**, 339 and 360 (1919), or the monograph: *Valenzkräfte und Röntgenspektren* (Springer, 1921).

† This term is due to R. Abegg, who prepared the way for Kossel's theory.

‡ Journ. Amer. Chem. Soc., **38**, 762 (1916); cf. also, as an extension of these views, J. Langmuir, *ibid.*, **41**, 868 (1919).

§ Born and Landé, Verh. d. D. Phys. Ges., **20**, 210 (1918); Born, *ibid.*, **20**, 230 (1918).

based, indeed, on exact calculations of the density and compressibility of crystals of the type NaCl. Landé* then set himself the difficult task of investigating the dynamical possibility of the cubic arrangement, which was, originally, only a postulate. He proceeded, not by supposing the electrons fixed in the corners of the cube (statical cubic model), but by inquiring after orbits in which they can keep themselves dynamically in equilibrium, whilst preserving their cubical symmetry. It is indeed enticing to bring the sacred number 8 of the periodic system into relationship with the number of corners of a cube and to picture the chemical ideal of the 8-shell in the form of the cube. At any rate this is a first step towards solving the problem, proposed at the end of § 3, of getting tangible ideas of the shell arrangement of the electrons in the atom. But, apart from the fact that a more detailed discussion of this question would again take us too far, we must not omit to mention that recently Bohr (in the letter to "Nature" quoted on pp. 59 and 69) has raised objections of a general character against this perhaps already too specialised picture. Presumably the symmetry of arrangement that was demanded by Born to explain in particular the compressibility of regular crystals, remains unaffected by these objections.

It has been held up as a reproach to Kossel's line of reasoning, that, in the effort to trace chemical actions back to electrostatic forces alone, it has neglected the quintessence of the modern physics of the atom, namely, the quantum theory. The author is of the opinion that in Kossel's theory the quantum ingredient is represented by the fact that, going beyond Berzelius, Kossel takes the atomic volumes (better, the ionic values) into account whereby, for example, the decrease in the intensity of the polar union with increase of atomic size is explained according to Coulomb's law. In fact, the *size* of atoms is given, according to our modern view, merely by the extent of their peripheral electronic orbits, and these, in turn, are determined essentially by quantum relations and quantum numbers (cf. what was said about hydrogen in §§ 3 and 4). So that as Kossel works with impenetrable atomic shells, latent quantum effects are involved in his calculations.

This brings us for a moment back once again to the curve of atomic volumes, with which we started this section. The downward course of the curve at the beginning of each period may be made clear quite simply, if superficially, by the following consideration. In the case of a neutral atom of an alkali metal, an external electron is situated in the field of an atomic residue carrying a single positive charge. In the case of a metal of the alkaline earths, or of the following group, if they are electrically neutral we have two or three outer electrons in the field of a doubly or trebly charged positive atomic residue. If we assume that these two or three electrons move in a circle diametrically, or at equal distances from

* Berliner Sitzungsber., 1919, p. 101; Verh. d. D. Phys. Ges., 21, 2, 644, 653 (1919); Zeitschr. f. Phys., 2, 83, 380 (1920).

one another, respectively (which need not be accepted, of course), and if we extend this idea to the following column of the vertical system (for which the arrangement in a circle obviously seems very doubtful, in view of the tetrahedral valencies of carbon), we may make use of equation (5), of page 74, to determine the orbital radius of the outer electrons. In every period this radius, then, comes out as inversely proportional to $Z_{\text{eff}} = Z - p - s_q$. Here q is, for all columns from the first to the fourth, equal to 1, 2, 3, 4, and s_q , according to Table 3, of page 76, is equal to 0.00, 0.25, 0.577, 0.957. Further, $Z - p$, that is, the nuclear charge *minus* the number of electrons of the atomic residue that screens it off, is likewise, on account of the neutrality of the whole atom, equal to 1, 2, 3, 4. We may, therefore, write down the following table:—

TABLE 7

q	1	2	3	4
Z_{eff}	1	2.925	3.0577	4.0957
$\frac{1}{Z_{\text{eff}}}$	1	0.57	0.41	0.33

The bottom line gives, according to equation (5) of page 74, a measure for the radius of the peripheral shell (imagined circular) of the atom, and it shows how it diminishes step by step under the influence of the gradually increasing charge of the atomic residue. We have thus a qualitative* counterpart to the descending branches of the curve of atomic volumes. Our argument clearly furnishes us with no analogy for the ascending branches at the ends of the periods, particularly if we retain the idea of a circular ring (which is in this case certainly inadmissible).

Of greater practical importance for chemical purposes, we find the ionic volume, inasmuch as it asserts itself directly in the polar compounds of the solid crystalline state. From the point of view of theory, too, the ionic volume is better defined and more easily accessible than the atomic volume, in the interpretation of which the difficulties of the homöopolar union, and in the case of metals, in particular, our ignorance

* It is very surprising that if we form the "relative atomic volumes" from Lothar Meyer's curve in each case, that is, the atomic volume in the second, third, and fourth column divided by that of the preceding alkali in the first column, we get almost the same figures, and, indeed, the same for each period. This might tempt us, for example, to calculate the not yet experimentally determined atomic volume of scandium from that of potassium, which is the alkali that precedes: we would get 0.41, 45.5 = 18.6. In the previous editions of this book, the remarkable parallelism between the real course of the atomic volumes and the calculation of atomic radii, sketched out above, was discussed further. In its quantitative aspect, it is an unsolved mystery, for atomic volume is the third power of a length, whereas our atomic radius is the first power of a length. Consequently we have restricted ourselves to the brief indications of the text.

of the disposition of the conduction of electrons, makes itself felt. Thanks to the courtesy of Mr. H. Grimm * the author is in a position to exhibit a curve (Fig. 26) of ionic sizes, as a counterpart to the Lothar Meyer curve. There are still gaps in it, and its absolute values are a little uncertain, but its course is characteristic and full of meaning.

The atomic numbers are marked off along the abscissa, and the ionic sizes R (defined as the radii of the sphere circumscribed about the 8-configuration in question) are marked off along the ordinate axis. Branch I of the curve represents all those ions that tend to the neon type from the one side or the other; the curves II, III, and IV relate to those ions that, similarly, belong to A, Kr, and X respectively. For example, on the branch I we find, besides Ne itself, if we start from Ne and pass succes-

sively downwards, that is, to smaller ionic sizes and greater atomic numbers, Na^+ , Mg^{++} , and, on the other side, that is, to greater ionic radii and smaller atomic numbers, F^- , O^- . Corresponding to this, we find for the Argon branch, on the one side, the group K^+ , Ca^{++} , and on the other Cl^- , S^{--} . The steep slope of all the branches is explicable from the same point of view as receives expression in the descending branches of the curve of atomic volumes of Table 7, namely, the same outer shell of electrons as occurs in the neutral inert gas is contracted by electrostatic attraction when the nuclear charge increases, and becomes distended by electrostatic repulsion as the nuclear charge decreases. For example, we get the rule that *the negative ions are greater than the positive ions*. The unique position of the alkalis that was so prominent at the maxima of the curve of atomic volumes, has vanished entirely in our ionic curves. This is easy to understand, since the single valency electron that was responsible for this unique position of the alkalis is no longer present in the ions.

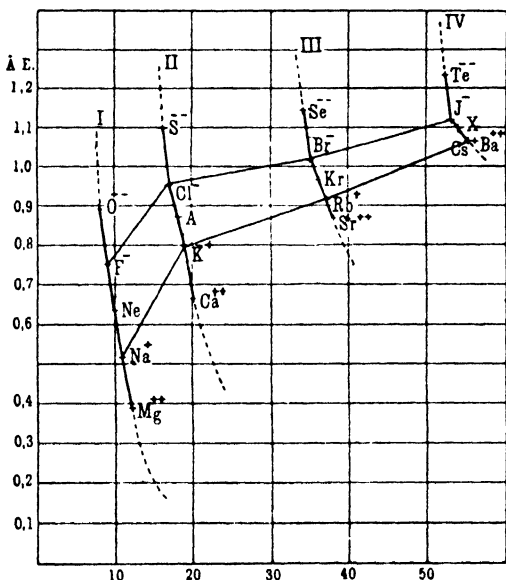

FIG. 26

In Fig. 26 we have drawn in addition to the curves that run from above to below and that belong to the same *period*, two connecting lines, from left to right, that link up the ions in the same *group* of the periodic

* Cf. Zeitschr. f. Physikal. Chem., 1921.

system, namely, the alkali and the halogen ions. Concerning the differences between the consecutive steps of these connecting lines, we read from the figure the following rule :

$$I \ II > \ III \ IV > \ II \ III.$$

And, indeed, this rule holds not only for ionic sizes but also for numerous other physical properties, and not only for the alkalies and the halogens, but also for other groups of the periodic system. In particular, the height of the step I II tells us why, in isomorphic crystals, the ions II, III, and IV can be represented by one another isomorphically but not by I.

Concerning the empirical origin of the ionic radii, the hint must suffice that it is founded on the measurement and calculation of the width of mesh of crystal lattices of the type NaCl. Fajans, Grimm, and Herzfeld,* starting from the cube conception, have set up and tested simple linear formulæ that connect the molecular volumes of crystallised salts with one another, and their lattice constant with the ionic size of the component parts. In the case of the inert gases, of course, the ionic radii (here atomic radii) could not be determined in this way, but they have been inserted as the arithmetic means of the alkali and halogen ions. A check for this is furnished by the work, determined spectroscopically, that is necessary to form the ions, starting from an initial neutral state (cf. Chap. VI, § 3).

So much for the *outer* shells of atoms and ions. Now, what does the periodic system tell us about the *inner shells* and how they are occupied by electrons? As already explained above, we may assume that each new period marks the beginning of a new shell, whereby the one just completed becomes the shell second from without. Thus, *the periodic numbers*

$$2, 8, 8, 18, 18, 32$$

give us an index of the probable numbers of the electrons that occupy the successive inner shells.

But this does not imply that, as we proceed in the system, the numbers of electrons in the inner shells remain the same, or even the same as the numbers of electrons which occupied the same shells when these formerly were complete as outer shells of a former element. It is easy to see that the conditions of stability in an inner shell are different, and indeed more favourable, than when the same shell formed the periphery of the atom. As an inner shell it would thus (as a consequence of the repulsive action of the newly added outer electrons) be able to hold more electrons than when it formed the periphery of the atom. Hence it may happen that at certain points of the periodic system a new electron that is added is not attached to the outside, but takes up a position in an inner shell. The points that come into question for this phenomenon are

* Zeitschr. f. Phys., 2, 299 and 309 (1920). •

the triads, FeCoNi, RuRhPd, OsIrPt, and the whole group of rare earths. These elements are closely related chemically and hence we surmise that the number and arrangement of their external electrons is the same.

These considerations which were undertaken some time ago,* have received a much firmer foundation through the later views of Bohr, which were accompanied by calculations, and which he communicated to us at the conclusion of his letter to "Nature" (cf. p. 69). According to these views, the successive shells in the case of the inert gases are occupied by the following number of electrons:—

TABLE 8

He	2				Kr	2	8	18	8		
Ne	2	8			X	2	8	18	18	8	
A	2	8	8		Em	2	8	18	32	18	8

As we see, these numbers at first increase and then decrease to 8 again. *All inert gases are surrounded by an outer 8-shell. The numbers of elements in the periods of the natural system do, indeed, furnish us with the correct strengths (Besetzungszahlen) of the shells, but, in general, not in the right order of sequence.*

How are we to represent to ourselves the difference between the period numbers of the system and the strengths of the shells in individual cases? Between A and Kr a first rearrangement of the electronic configuration occurs. The completed 8-shell of A is not preserved in the case of Kr, but is re-formed into an 18-shell. The point of the periodic system, at which this occurs, is occupied by the triad FeCoNi. The same arrangement occurs a second time between Kr and X, namely, at the point occupied by the triad RuRhPd. The third revolution is very radical and leads to the formation of an inner shell of thirty-two electrons; it has a connexion with the occurrence of the rare earths in the periodic system.

From these remarks we see how the problems of atomic structure are transfused with questions relating to the periodic system, and we recognise that advances in problems of the former kind also entail the unravelling of those latter types.

* Physikal. Zeitschr., 19, 229 (1918). Cf. also L. Ladenburg, Naturwiss., 1920, Heft 1, in which he conjectures that a rearrangement of the external shell of electrons takes place before the middle of the great periods, and in which he comes to the conclusion that not only the inert gases Ne and A, but also Kr and X must have an 8-shell on the outside.

CHAPTER III

X-RAY SPECTRA

§ 1. Laue's Discovery *

IN our introductory note on Röntgen or X-rays (Chap. I, § 5), we saw that Röntgen radiation is a *radiation of transverse waves*. We spoke of the *wave-length* and of the *spectrum of X-ray radiation*, both in the case of the *characteristic radiation*, which is the part that is characteristic of the material composing the anti-cathode, corresponding to the free vibrations of the electrons of the anti-cathode, and in that of the *impulse radiation*, which is the part that is characteristic of the voltage of the X-ray tube, corresponding to forced radiation of the electrons of the cathode rays. Assuming the results of experiment, we described the spectrum of the *characteristic radiation* as a *line-spectrum*, that is, as a discrete series of individual wave-lengths, and the spectrum of *impulse radiation* as a *continuous spectrum* which stretches from long wave-lengths over a region of maximum intensity to a sharply defined edge of short wave-length. In both cases the wave-length (the dominant wave-length, the region of greatest intensity) is an inverse measure of the *hardness*, a direct measure of the *softness*, of X-rays.

How are the wave-lengths of X-rays measured? The general properties of X-rays, compared with those of visible light, show that their wave-lengths must be very much smaller than optical wave-lengths. In optics the best method of measuring wave-lengths, and the only method that leads to absolute determination of them, is that founded on *diffraction*. By measuring the positions of the maxima and minima of diffraction, we compare the wave-length with the dimensions of the diffracting aperture and in this way reduce it to absolute measure. The greater the wave-length of the light used, the less will be the distances between the diffraction fringes and the more will the path of the ray deviate from that of a straight line. Red will be diffracted more than blue, the diffracting aperture being of the same size for both. Conversely, the smaller the diffracting aperture, the greater will be the angle of diffraction for a constant wave-length of light. From this it is clear that the dimensions of the

* Laue has given a comprehensive account of his discovery in *Jahrbuch für Radioaktivität und Elektronik*, **11**, 308 (1914). Its application to crystal analysis is described in the book, "X-Rays and Crystal Structure," by W. H. Bragg. London, 1916 (Bell).

diffraction apparatus must be chosen much finer in the case of Röntgen rays than in that of ordinary light.

As early as 1895 Röntgen himself had made tentative diffraction experiments with his X-rays, but the result was negative. Results by other experimenters, which were claimed to be positive, were later proved to be due to optical illusions, half-shadow effects arising from the scattering of the secondary radiation. Accurate diffraction photographs were first obtained in 1900 by Haga and Wind, who used a slit that was placed perpendicular to the course of the ray; the jaws of the slit were not, as is usual, parallel to one another, but met at the lower end, so that its opening, which had a width of several μ at the upper end, became reduced to several $\mu\mu$ at the lower end. The diffraction effect was to manifest itself in a broadening of the dark band of the negative at the lower end of the slit. These photographs were repeated with greater refinement by Walter and Pohl. The plates were worked out by the author, after P. P. Koch* (of Hamburg) had measured them out photometrically with great care by his own method. From a photograph taken with hard Röntgen radiation the dominant wave-length ("width of impulse," as it was called at that time) was found by calculation to be $\lambda \cong 4 \cdot 10^{-9}$ cms. Contrast with this the wave-length of yellow light, which is $6 \cdot 10^{-5}$ cms.

The fact that the wave-length determines qualitatively the hardness of the X-ray tube becomes clear when we compare the two diffraction negatives which have been worked out photometrically by Koch in Fig. 27 (a) and (b). The negatives were produced by Haga and Wind; in the case (a) they used a very soft tube, in the case (b) a very hard one. They both present the left half of the picture of the wedge-shaped slit, of which the geometrical shadow is indicated by the dotted line (the right half is to be imagined added symmetrically about the middle line MM). The continuous lines are lines of equal darkness on the photographic plate, and we see that the intensity of darkness decreases from the middle to the side. In the absence of diffraction (wave-length $\lambda = 0$) darkness would occur only within the geometrical shadow of the slit and a neighbouring region of penumbra. Now, a characteristic feature is exhibited in that, in Fig. 27 (b) (hard tube), the curves of equal darkness are closer to the geometrical projection of the slit than in Fig. 27 (a) (soft tube). Thus, the diffraction, that is, the deviation of the path of the ray from that demanded

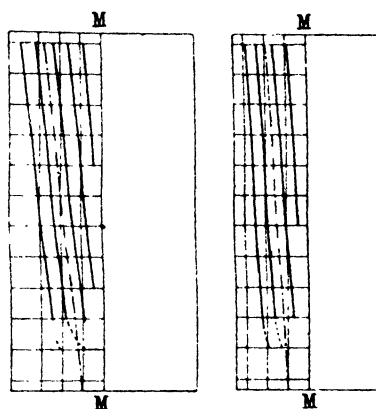

FIG. 27 (a) and (b)

* P. P. Koch, Ann. d. Phys., **38**, 507 (1912).

by geometrical optics, is thus less in the case of greater hardness; *greater hardness corresponds to shorter wave-length.*

Only a year after these results were made known, this determination of wave-lengths was to be surpassed in accuracy and certainty in an undreamt-of manner by Laue's discovery.

In optics, the diffraction grating is more effective than the diffraction slit, both as regards the intensity of its light and its resolving power. The action of the diffraction grating depends on the regular succession of the lines of the grating, the distance between which we shall call the "grating constant" a . The width of the form of these lines have no influence on the angle of diffraction and are only of secondary importance even for the distribution of intensity among the spectra of various orders.

The theory of the diffraction grating is one of the most familiar branches of the optics of the wave theory. Nevertheless, to lay bare the root of Laue's discovery, we must here set out some of its essentials.

In Fig. 28 we exhibit a section of the grating; 1, 2, 3, . . . are the traces of the lines of the grating; the distances $(1, 2) = (2, 3) = \dots$

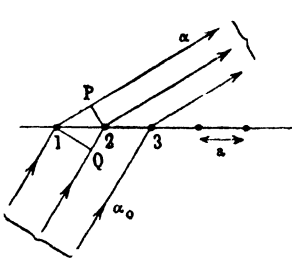

FIG. 28.

are equal to the grating constant a . Let the angle between the incident beam of rays and the trace of the grating 1, 2, 3, . . . have the direction cosine a_0 , the direction cosine of the emergent beam and the same line 1, 2, 3, . . . being a . (a_0 and a are simultaneously the sines of the angles of incidence and emergence.) Using Huyghen's Principle, let us imagine rays starting out from each grating line in all

directions. Thus, for the present, we may regard a as any arbitrary angle whatsoever. In the figure the case of *transmitted* light is pictured. By folding the diffracted rays in the figure about the axis 1, 2, 3, . . ., we get the case of light reflected by diffraction.

The theory of the diffraction grating is contained in the equation :

$$a(a - a_0) = h\lambda \quad . \quad . \quad . \quad (1)$$

In (1) the left-hand side denotes the difference in length of path between the ray, for example, that goes through aperture 1 and that which goes through aperture 2 (and, generally, the difference of path between any such ray and its neighbours). For $a a = 1P$ is the difference of path between the diffracted rays through 1 and 2, and likewise $a a_0$ is the difference between the lengths of path of the incident rays through 2 and 1. Thus our equation demands that the path-difference in the whole course of the rays be equal to a wave-length, or a multiple of the wave-length (that is, h must be an integer). In this case we get an amplification of intensity through interference, that is, a diffraction maximum.

We get diffraction minima, that is, a neutralisation of intensity by choosing $h = \frac{1}{2}$, or $h = \text{an integer} + \frac{1}{2}$.

In the first place, equation (1) shows that the diffraction grating is a spectral apparatus, inasmuch as it gives for each wave-length λ a definite angle of diffraction. Hence incident white light is analysed into its spectral components. Again, red is more strongly diffracted than blue. For $h = 1$, we get a *spectrum of the first order*; for $h = 2$, we get one of the *second order*, and so forth. Corresponding to the case $h = 0$ is *direct light*, which is not resolved spectrally. On the other side of the direct ray spectra of the first, second, . . . order also occur, namely, for $h = -1$, $h = -2$, and so forth. The separation of the colours (the *dispersion*) is double as great for a spectrum of the second order as for one of the first order, and so forth. Further, equation (1) tells us that the *grating constant* a must be greater than λ , but not *too much* greater. For if $a < \lambda$, we should have $h \frac{\lambda}{a} > 1$, and hence $h \frac{\lambda}{a}$ could not be equal to $a - a_0$, as is demanded by (1) (since $a - a_0$, being the difference between two cosines, is < 1). If, on the other hand, $a \gg \lambda$, then $a - a_0$ will become very small for moderate values of h , and the spectra of first, second, . . . order, if caught on a screen, would lie very close to the direct light; the dispersion would be insufficient and the grating would fail to be of use as a spectral apparatus. In the case of Rowland gratings, which are of perfect construction $\frac{a}{\lambda}$ amounts to less than 10 units.

Besides the grating constant a , a decisive feature for the excellence of a grating is the number of lines N of the grating. It conditions not only the brightness of the diffraction spectra, as is immediately apparent, but also the **resolving power** of the grating, that is, the power to separate and make measurable spectral lines whose wave-lengths differ only slightly from one another. The resolving power is given directly by the number of lines N .

From the simple line-grating we pass on to the **crossed grating**, or **lattice**. Every one knows the beautiful diffraction spectra that are presented to the eye when we look at a distant source of light through gauze. We shall confine our attention in particular to a quadratic system of fine apertures, that is, we suppose the threads of the web or network to run at right angles to one another and suppose them to be comparatively thick, so that the intermediate spaces that let through the light may be regarded as mere points. The distance between each two neighbouring apertures is to be called the "lattice constant" a . In Fig. 29 we take two rows of such apertures as our x - and y -axis; we draw a z -axis perpendicular to both. We cannot picture the course of the beam for the incident and diffracted rays since their paths lie in space. Nevertheless we may say exactly as in Fig. 28 let α_0, β_0 be the direction cosines of the incident ray with respect to the x - and y -axis, respectively;

let α, β be those of the diffracted ray. In the diffracted ray the contributions of all apertures are to strengthen one another additively as a result of the interference. For example, let us consider the contributions of 1 and 2. If they strengthen one another then

$$a(\alpha - \alpha_0) = h_1\lambda \quad \dots \quad (2)$$

where $h_1 =$ an integer. The projection of the distance a of the lattice-points 1 and 2 on the incident and the diffracted ray gives us precisely Fig. 28 (only that, where necessary, the upper and lower half-planes in Fig. 28 must now be considered inclined to one another) and thus proves the truth of (2). In the same way the contributions of 1 and 2' are to act additively through interference. To assure this, we must have

$$a(\beta - \beta_0) = h_2\lambda \quad \dots \quad (2')$$

where $h_2 =$ an integer. This equation, too, may be read off from Fig. 28, if we project the distance between 1 and 2' on the incident and the diffracted ray. But if 1 acts together with 2 and 2' to produce increase of brightness as a result of the interference, then every opening acts in the same sense, since, then, the difference of path between each two openings is equal to a whole number of wave-lengths.

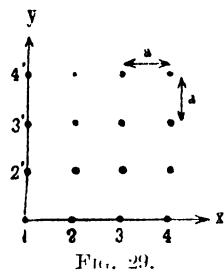

FIG. 29.

Likewise the lattice (crossed grating) resolves the incident light into its spectral components. For, from equations (2) and (2'), if h_1 and h_2 are given, there is defined for each λ a different direction of the diffracted rays. We construct the path of this ray as follows. We describe about the

x -axis of Fig. 29 a cone such that the cosine of its angle of aperture is equal to the direction cosine α , as obtained from equation (2). In the same way we describe about the y -axis a cone which is similarly determined by the direction cosine β given by (2'). These cones intersect in the ray whose position we require (as well as in the ray that is symmetrical to the latter with respect to the xy -plane, the lattice acting, so to speak, as a reflecting plane). Our construction holds for a definite wave-length λ . For a new λ the apertures of the cones must be altered to accord with (2) and (2'), and thus we get a new direction for the diffracted ray. Hence, for given values of h_1 and h_2 we obtain a *spectrum*, which corresponds to the two *order numbers* h_1, h_2 , and by varying h_1, h_2 we get a *two-fold manifold of spectra*. Each of these spectra repeats the complete series of spectral colours from red (on the outside) to violet (on the inside), with the exception of the spectrum (0·0), the continuation of the incident ray, which is not analysed in this special case. The spectra (1·0), (2·0), (3·0) . . . lie in the plane through the incident ray and the x -axis; the spectra (0·1), (0·2), (0·3) . . . lie in the plane through the incident ray

and the y -axis. The spectra (1·1), (2·2), (3·3) . . ., further, are situated in the plane through the incident ray and the bisectors of the angle between the x -axis and the y -axis, and so forth for the other spectra. Besides the spectra $(+h_1, +h_2)$, there are, allotted to the other quadrants of the xy -plane, spectra $(+h_1, -h_2)$, $(-h_1, +h_2)$, and $(-h_1, -h_2)$. As in the case of the line-grating we must have $a > \lambda$ but we cannot allow $a \gg \lambda$. The equations (2) and (2') comprise the whole theory of the crossed grating or lattice, just as equation (1) comprised the theory of the line-grating. Concerning the resolving power of the lattice, the numbers N_1, N_2 of the lattice aperture in the one or the other direction serve as indices.

From the crossed grating or plane-lattice we pass on to consider the case of a **space-lattice**, for example, a cubical space-lattice. We may imagine that there is added to the quadratic system of openings of Fig. 29 a whole system of similar systems placed one behind another at equal distances a . For this purpose we prefer to talk, not of "apertures," but of "**lattice-points**," which act as "**diffraction centres**" or as "scattering points." Thus we have a cubical system of lattice-points, of which each two neighbours are separated by a distance equal to the lattice constant a along the direction of each axis, x, y, z . We allow light to fall into the system of lattice-points in the direction $\alpha_0\beta_0\gamma_0$ (these being the direction cosines with respect to the three axes, respectively). At each of our lattice-points a fraction of the incident light will be diffracted or scattered in all directions, for example, in the direction $\alpha\beta\gamma$. At a great distance from our space-lattice the waves that emerge in the direction $\alpha\beta\gamma$ from each lattice-point form a homogeneous ray, namely, the ray $\alpha\beta\gamma$ diffracted by our space-lattice. (In order that this ray might form without obstruction in all directions, it was necessary to replace the idea of "diffraction apertures" by that of "diffraction centres," otherwise the formation of the diffracted ray would be impeded by the diffracting screens that we should have to assume between the diffraction apertures.)

The diffracted ray $\alpha\beta\gamma$, however, is appreciably bright only when the contributions of all the lattice-points act together in the same phase in producing it. For this it is necessary that the path-difference of the rays from neighbouring lattice-points be a whole number of wave-lengths. Thus we arrive at *three conditions*, one for the direction of x (that is, for two neighbours that are at a distance a from one another in the direction of x), one for the y -direction, and one for the z -direction :

$$a(\alpha - \alpha_0) = h_1\lambda \quad . \quad . \quad . \quad . \quad (3)$$

$$a(\beta - \beta_0) = h_2\lambda \quad . \quad . \quad . \quad . \quad (3')$$

$$a(\gamma - \gamma_0) = h_3\lambda \quad . \quad . \quad . \quad . \quad (3'')$$

When these conditions are fulfilled, the effect of interference is to amplify the intensity, and indeed, not only of that due to two neighbours but generally, to that due to any two of our lattice-points, since for them the path-difference is a whole multiple of the difference of path for two

neighbours. These rays that are thus intensified as a result of interference from all the lattice-points are, furthermore, the only ones that are appreciably bright. For, in the case of a sufficiently great number of lattice-points (N_1, N_2, N_3 in the three co-ordinate directions), rays that are intensified through the combined action of only a fraction of these lattice-points (for example, only the lattice-points, N_1 and N_2) would appear infinitely faint compared with those discussed above.

Equation (3) comprises the essential features of the theory of the space-lattice. We read out of it that: *every interfering ray is characterised by three whole numbers (h_1, h_2, h_3) the order numbers of the interference phenomenon in question.* We cannot, however, as before speak of a *spectrum* of the order (h_1, h_2, h_3). The light that is diffracted by the space-lattice no longer contains all the wave-lengths in juxtaposition, as happens in the case of the crossed grating or plane-lattice; it is, on the contrary, *monochromatic light*.

From equation (3) it follows that

$$\alpha = \alpha_0 + h_1 \frac{\lambda}{a}, \quad \beta = \beta_0 + h_2 \frac{\lambda}{a}, \quad \gamma = \gamma_0 + h_3 \frac{\lambda}{a}. \quad (4)$$

Moreover, we have the Pythagorean relation between the direction cosines:

$$\alpha^2 + \beta^2 + \gamma^2 = 1, \quad \text{and likewise} \quad \alpha_0^2 + \beta_0^2 + \gamma_0^2 = 1. \quad (5)$$

By squaring each member of (4) and then summing, using (5), we get

$$1 = 1 + 2(h_1\alpha_0 + h_2\beta_0 + h_3\gamma_0) \frac{\lambda}{a} + (h_1^2 + h_2^2 + h_3^2) \frac{\lambda^2}{a^2}$$

and hence,

$$\lambda = -2a \frac{h_1\alpha_0 + h_2\beta_0 + h_3\gamma_0}{h_1^2 + h_2^2 + h_3^2}. \quad (6)$$

Thus, the wave-length that can be diffracted in the interference ray of order (h_1, h_2, h_3) is fully determined for a given direction of incidence. We may express this in some such terms as these: The third condition that becomes added to those of the plane-lattice, when we deal with space-lattices, singles out one wave-length from all those of the plane-lattice, and excludes the others. We illustrate this by a conical construction analogous to that which we have already used in the case of the plane-lattice. About the x -, y -, z -axis in turn we describe cones whose angular apertures have cosines such as are demanded by equation (4). Two of these will intersect, whereas the third will not, in general, pass through a line of intersection of the other two. But the latter condition is absolutely necessary if the amplification produced by interference is to reach full strength. Hence, for an arbitrarily chosen λ , there will, in general, be no diffracted ray. By altering λ we also alter, according to (4), the conical apertures continuously. We may carry out the change of λ in such a way that the sheet of our third cone gradually approaches the intersection of our first two cones. If we proceed in this way we shall

succeed, at a certain value of λ , in making all three cones have a common line of intersection. This is the interference ray ($\alpha\beta\gamma$); the corresponding wave-length is that which was calculated in (6).

From equation (3) we shall straightway make a further deduction. For this purpose we introduce the following symbols (cf. Fig. 30): 2θ is to denote the angle between the incident and the diffracted ray, that is, θ is the angle which the incident or the diffracted makes with the middle plane MM between both. We then have

$$\cos 2\theta = \alpha\alpha_0 + \beta\beta_0 + \gamma\gamma_0 \quad (7)$$

By squaring each member of (3), then summing and using (5) and (7), we get

$$\begin{aligned} (a - a_0)^2 + (\beta - \beta_0)^2 + (\gamma - \gamma_0)^2 &= 2 - 2 \cos 2\theta = 4 \sin^2 \theta \\ &= (h_1^2 + h_2^2 + h_3^2) \frac{\lambda^2}{a^2} \end{aligned} \quad (8)$$

Taking the square root, we get

$$\sin \theta = \frac{\lambda}{2a} \sqrt{h_1^2 + h_2^2 + h_3^2} \quad (9)$$

We shall find that this equation will be of fundamental importance in § 3.

In the region of optics our space-lattice is only a fiction, a model which we have conceived so as to generalise the scheme of diffraction as presented by ordinary diffraction gratings. The art of the mechanic and of the weaver are of no avail for producing such space-lattices. In the realm of Röntgen radiation, the position is different. The brilliance of Laue's idea consisted in his recognising that the space-structure of crystals is just as happily adapted to the wave-length of Röntgen radiation, as the structure of a Rowland grating was adapted to the wave-length of ordinary light, that is, that we can take directly out of the hands of Nature the diffraction apparatus necessary for Röntgen rays, in the form of one of her masterpieces, a crystal of regular growth.

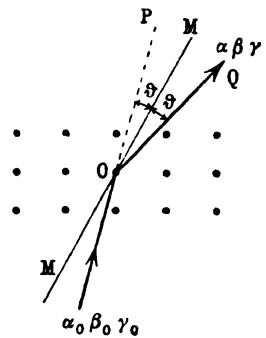

FIG. 30.

It was a favourite idea of mineralogists and mathematicians (Hauy, Bravais, Sohnke, Fedorow, Schönflies) to account for the regular shape and structure of crystals by the regular arrangement of their elements of structure, of their molecules or atoms. According to this, a lattice of the cubical type would have to be ascribed to a crystal of the regular or cubical system. If we determine the lattice constant a of such a crystal from the density of the crystal and the mass of the atoms composing it (as we shall do at the end of § 3 of this chapter for the case of rock-salt), we find that a is of the order of magnitude 10^{-8} (for example, $a = 5.6 \cdot 10^{-8}$ in the case of NaCl). This is the same order as that

which has been found for the sphere of action of molecules, according to various methods of determination founded on the kinetic theory of gases. On the other hand, we saw at the beginning of this section that the wave-length of Röntgen rays is to be placed between the orders of magnitude 10^{-8} and 10^{-9} cms. ($4 \cdot 10^{-9}$ for a hard tube, according to a rough calculation based on the diffraction). We assert then that *the lattice constant a of the crystal is greater than the wave-length λ of the Röntgen rays, but not too great in comparison with them.* Thus a and λ are related to one another in just the way that we found above is necessary if a diffraction apparatus is to be effective. We can read the same condition out of equation (9); if $\frac{\lambda}{a}$ is a proper fraction that is not too small, we get for the

angle of diffraction 2θ , a possible and not too small value. The atoms that compose our space-lattice are directly effective as lattice-points. We

encountered in Chapter I, § 5, their property of forming diffraction (or scattering) centres for Röntgen rays; there we saw that their scattering is proportional to the number of electrons Z contained in them.*

Figs. 31, 32, 33 are reproductions of the famous photographs taken by Laue, Friedrich, and Knipping early in 1912. The experiment was arranged very simply. By means of lead guides (screens with holes), a fine beam was separated out of the light from an X-ray bulb. This beam

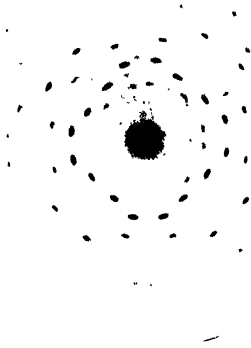

FIG. 31.

falls on a crystal plate—in the plates reproduced these were of zinc blende, ZnS —about 0.5 mm. thick, 5 mm. wide and long, which was mounted on a spectrometer table, and capable of being accurately adjusted with it. When the incident “primary” ray traverses the crystal plate, secondary “interference” rays are deflected out of it owing to diffraction by the atomic lattices of the crystal. These interference rays emerge from the crystal as a widely divergent beam of many members. Several centimetres behind the crystal is the photographic plate. On it there is traced besides the primary ray (greatly magnified owing to irradiation) the track of the beam of interference rays. In the first photographs the time of exposure was many hours; the tube was run with about 3 milliamps. and 60 kilovolts. The plate and the crystal were protected by being surrounded by lead.

In Figs. 31 and 32 the crystal plate was cut parallel to the edge of the cube and placed at right angles to the incident ray, with the difference

that in Fig. 31, the photographic plate was 3.5 cms. from the crystal, whereas in Fig. 32, the distance was only 1 cm. Thus Fig. 32 is a section through the same interference beam as Fig. 31, but greatly compressed and reduced in size. In Fig. 31 as well as in Fig. 32 the primary ray travelled in the direction of the four-fold axis of symmetry (edge of the cube). Correspondingly, the respective diffraction pictures are of four-fold symmetry. They have four planes of symmetry, two parallel to the edges, two parallel to the diagonals of the cube surface. Every spot that lies on one of these planes of symmetry in the picture occurs four times whereas every other spot occurs eight times. Each such group of connected spots that again arises from itself by rotation and reflection shows the *same intensity* and is marked on the plate by the same *wavelength*. If the photographic plate and our retina were sensitive to the imaginary colour of Röntgen rays, we should see each such group of points shining forth in one pure colour and each two different groups of

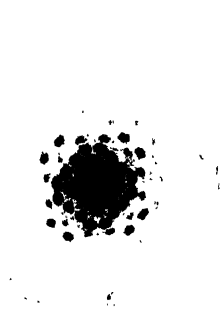

FIG. 32.

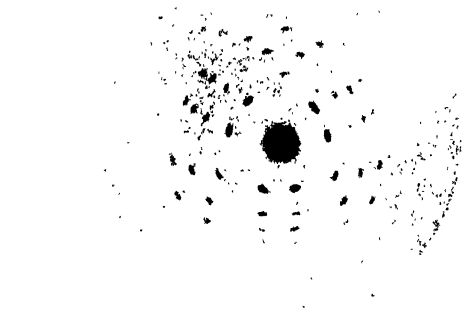

FIG. 33.

points in general emitting different colours. For example, there belong to the two particularly strongly pronounced 8-groups of spots in Figs. 31 and 32, the fractional numbers

$$\frac{\lambda}{a} = \frac{2}{27} \text{ and } \frac{\lambda}{a} = \frac{2}{35} \text{ respectively.}$$

Since the lattice constant for zinc blende is found to be

$$a = 5.43 \cdot 10^{-8} \text{ cms.}$$

we get the corresponding wave-lengths as

$$\lambda = 4.02 \cdot 10^{-9} \text{ cms. and } \lambda = 3.11 \cdot 10^{-9} \text{ cms.}$$

In Fig. 33, the crystal plate was cut parallel to a space diagonal of the cube, which represents a triply symmetrical axis for the substance of the crystal. The primary Röntgen radiation again fell perpendicularly on the plate, and thus traversed the crystal in the direction of one of its *three-fold* axes. Corresponding to this, Fig. 33 is of three-fold symmetry: it

possesses three planes of symmetry inclined to one another at an angle of 120° . In general, each spot occurs six times, but in a particular position on one of these planes of symmetry it occurs three-fold. Each 3- or 6-group of spots, respectively, is produced by the same wave-length. For example, in the case of the very prominent 6-group of spots we have

$$\frac{\lambda}{a} = \frac{2}{19\sqrt{3}} \quad \lambda = 3.30 \cdot 10^{-9} \text{ cms.}$$

The wave-lengths that are singled out in this way by the crystal structure and are diffracted to definite points of the photographic plate are all contained in the primary bundle of rays, just as the colours of the rainbow are contained in the white light of the sun. In Laue's method the *continuous* spectrum is used to produce the interference picture. This continuous spectrum, however, is not, as in the case of the line-grating or plane lattice (crossed grating), mapped out completely, but certain individual wave-lengths (more accurately, several narrow regions of wave-lengths) that are appropriate for the crystal structure are selected from the continuous manifold of the spectrum and made prominent. The prominence of certain wave-lengths in the interference picture is partly due to the fact that they are particularly strongly represented in the primary spectrum (the region of maximum intensity of the continuous spectrum), and partly due to the fact that the photographic plate reacts particularly strongly to them (selective sensitivity of the silver bromide). Laue's method tells us nothing of the *line-spectrum*, of which the discrete wave-lengths are not in general adapted to the crystal structure. Since the line-spectrum, as the characteristic radiation of the atoms of the anti-cathode, is particularly important for the study of atomic structure, we shall not require to draw further from Laue's original method. Of course, the spectrometric methods that we shall discuss in the sequel will differ from Laue's method only in the mode of arrangement, not in the root idea. This idea, of using the crystal as an analyser for Röntgen rays, is as essential in them as in the original method.

So far we have given Laue's theory for the case of the regular system with the lattice constant a . How this is to be extended to the other systems of crystals suggests itself to us immediately. In the case of the rhombic system, which is built upon three mutually perpendicular axes, it is only necessary to replace the quantity a in equation (3) by the lattice constants, a , b , c , in the directions of the three axes respectively. We then get in place of equation (6)

$$\lambda = \frac{2}{\sqrt{\frac{h_1^2}{a^2} + \frac{h_2^2}{b^2} + \frac{h_3^2}{c^2}}} \cdot \frac{h_1 \alpha_0 + h_2 \beta_0 + h_3 \gamma_0}{\dots} \quad (10)$$

In the same way, equation (9) now becomes

$$\sin \theta = \frac{\lambda}{2} \sqrt{\frac{h_1^2}{a^2} + \frac{h_2^2}{b^2} + \frac{h_3^2}{c^2}} \quad (11)$$

The case of the tetragonal system is given by setting $b = a$. In the remaining crystal systems, in which the axes of the lattice are in general inclined against one another (oblique), the *direction angles* of the crystal axes appear in the corresponding formulæ, besides the *lengths of the edges*.

The roads of research opened up by Laue's discovery branch off in two directions. In one case we measure out the Röntgen spectrum of a given tube and of an anti-cathode of given material in terms of the lattice constants of a suitably chosen crystal. On the other hand, we measure out the structure of a given crystal in terms of a suitably chosen wave-length of a Röntgen ray. The results of the former type of research form the proper content of the present chapter. The following section gives a few indications of the second type of research, which does not belong to our real theme.

§ 2. Results of Crystal Analysis

In our description of Laue's discovery we have tacitly assumed the space-lattice to be formed exclusively of similar lattice-points, for example, as a simple cubical lattice. In reality, this is not the actual case. In dealing with non-elementary substances we are always concerned with lattices of different types of atoms fixed within each other. The structural elements of the crystal lattice are not *crystal molecules* but *crystal atoms*. The conception of molecules finds a place only in the gaseous and liquid state (in the latter, on account of varying polymerisation, it is already somewhat indeterminate), whereas in the solid, that is, the crystalline state, it is essentially resolved into the notion of atoms in juxtaposition. We do not deny that, in the structure of crystals, groups of atoms occur that are more closely related among themselves than with the remaining atoms of the crystal (for example, the group CO_3 in the structure of feldspar CaCO_3). Nevertheless we have a certain right to say that the whole crystal forms a single giant molecule. It would be arbitrary and would set an artificial restriction on many of the crystal models known at present to isolate from the totality of systematically arranged atoms, individual crystal *molecules*, corresponding to the chemical formula.

Accordingly, the object of crystal analysis is not only to determine the lattice constants of the system (linear and angular dimensions), but also to determine the mutual position of all atoms that participate in the crystal structure. The possibility of differentiating the various atoms from one another depends on the fact that their power of diffracting or scattering Röntgen rays varies. As we know (cf. Chap. I, § 5, p. 30, and Note 2), this scattering power is proportional to the number of scattering electrons contained in the atom, that is proportional to the atomic

number Z . Therefore the heavier atoms contribute more to the interference of X-rays than the lighter atoms. More precisely expressed, in the case of polar salts it is not, as we already know, the atoms themselves but their positive or negative ions that form the elements of structure of the crystal.* Hence we must regard as the measure of the scattering power, *not* the electronic number Z of the neutral atoms, but the number of ions, which differs from the former by one or, in the case of multi-valent ions, by several units. For example, in the case of rock-salt, NaCl, $Z = 11$ for Na and $Z = 17$ for Cl. But since the electropositive Na gives one of its electrons to the electronegative Cl, the scattering power of the ions actually present in NaCl is 10 in the case of Na^+ , and 18 in that of Cl^- . In sylvine, KCl, the two ions K^+ and Cl^- have an equally great scattering power, since the electronic numbers, $Z = 19$ for K, and $Z = 17$ for Cl, equalise themselves in the corresponding ions to the electronic number 18 which is that of the argon configuration (cf. the final section of the preceding chapter, p. 103).

For a more detailed investigation into the structure of crystals, the use of the **line-spectrum** proves to be more productive than that of the continuous spectrum. Whereas in Laue's method the wave-length varies from spot to spot and has to be carried along as an unknown in the interpretation of the interference picture, we avoid this unknown if we use the line-spectrum, and thus the problem is simplified. We shall see in the next paragraph how the experimental arrangements have to be altered for this process. The successes which Sir William Bragg and his son, Professor W. L. Bragg, have obtained in investigating crystal structure is widely ascribed to the fact that they used the "reflection method" as contrasted with Laue's "transmission method." But this view is erroneous. The advantage and the simplicity of their method is due essentially to the fact that they used discontinuous line-spectra. Thus the antithesis is not: *reflection method* and *transmission method*, but *discontinuous spectrum* and *continuous spectrum*.

A few examples will serve to illustrate the present state of crystal analysis. NaCl consists of a cubical lattice whose points are formed by alternate Na^+ - and Cl^- -ions, in such a way that each Cl-ion is surrounded by six Na neighbours (cf. Fig. 34, in which the two kinds of ions are represented by white and black heads respectively).

The Na-ions, taken alone, form a "*face-centred*" cubical lattice, likewise the Cl-ions taken alone. The lattices, both of which are congruent in themselves are placed within one another so that the points of one space-lattice occupy the centres of the edges of the other space-lattice. KCl, KBr, KI, LiCl, RbCl, and PbS (galena) have the same structure, the magnitude of a changing gradually.

On the other hand, in CsCl, the Cs-ions, for their own part, form a

* This beautiful and obvious result has been proved experimentally for the case of LiF by Debye and Scherrer (Phys. Zeitschr., 19, 1918, p. 474). •

simple cubical lattice, and the points of each lattice are situated in the middle points of the elementary cubes of the other lattice. Since it is known that CsCl becomes a modification of another form at the temperature 479°C ., we may assume that this other modification will be of the same face-centred type as the other alkaline halides. Further, we may assume that NaCl, etc., may also occur in two modifications but that the point at which the transformation into the simple cubical type takes place lie considerably below the room temperature. This assumption is supported by the fact that in the case of NH_4Cl both modifications are known and have been measured by means of Röntgen rays: at 20°C . the simple cubical form was found, whereas at 250°C . the face-centred type was found to be present. The point of transformation is at 184°C . NH_4Br and NH_4I gave similar results, the transformation points being 137°C . and -18°C . respectively.

Most of the regular elements, for example, Cu, Ag, Au, Al, Ni, Pb, and Th, crystallise in the form of *simple face-centred lattices*, as is shown in Fig. 34, if we imagine one type of ions removed from it. As, at present, we can make no certain statements about the state of ionisation of their structural elements, we speak, in this case, of atoms rather than of ions, without wishing to indicate, however, that they are necessarily uncharged.

It is characteristic of the stability of the face-centred arrangement that the lattice structure and the lattice distance remain quite unaltered even when the metals are produced by "spotting" or in sizes extending to the colloidal state. The individual particles in this state appear to consist only of a few hundred atoms.

Tungsten forms a *space-centred lattice*; its atoms are situated in the corners and in the centres of the space of the cube; the centres of the surfaces remain unoccupied. The same type of lattice has been found in the case of Li, Na, Fe, Cr, Mo, and Ta. A peculiar combination of space-centred and face-centred lattice occurs in cuprite, Cu_2O . In it the Cu-atoms form a space-centred lattice, whereas the O-atoms form a face-centred lattice. Their relative position may be described thus: connect the centre of a cube that is occupied by a Cu-atom with its eight corners; place in the middle of each alternate semi-diagonal an O-atom, leaving the intermediate diagonals unoccupied. In this way each Cu-atom is surrounded by a tetrahedron of O-atoms: all O-atoms together form a face-centred lattice, which is interlocked with the space-centred lattice of Cu-atoms.

A series of metals that crystallise hexagonally, namely, Mg, Zn (probably also Cd), and Be have a lattice form that is built up as follows: Fill up a plane in the form of a regular triangle with spheres that touch one another; place a second layer of spheres over these according to the

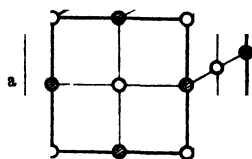

FIG. 34.

same scheme, so that they sink into the gaps of the first layer; the third layer then lies vertically above the first and sinks into the gaps of the second; the fourth layer lies vertically over the second, and so forth. The middle point of the spherical pile then corresponds "essentially" to the mid-points of the atoms in the hexagonal metals quoted (this is not to be taken as meaning that the surfaces of the atoms touch in just the same way as the spheres in our picture). "Essentially" signifies that the arrangement in the form of regular triangles is exactly realised not only in the horizontal plane but that in the vertical direction, too, the distance between the layers bears almost the same ratio to the side of the triangle as in the case of the spherical pile, with slight deviations between the individual elements.

From the point of view of crystallography this arrangement could be resolved into two interlocked hexagonal lattices of the simple Bravais type, the one consisting of the layers 1, 3, 5, . . . , the other of the layers 2, 4, 6, The circumstance, however, that just in the case of elementary substances always two such hexagonal crystals appear in conjunction, and that the ratio of their axes approximates to that of our spherical pile shows clearly that, not the resolution into two simple-hexagonal lattices, but our description by means of the spherical pile is, from the physical point of view, the description appropriate to the nature of the case.

The relationship that we get between this view and that given by the face-centred lattice, the other form in which simple elements present themselves, is also remarkable. For instance, if, starting from our first and our second layers, we build in the next layer not so that it lies perpendicularly over the first layer, but over the gaps left by the second layer, that is, so that the fourth, fifth, and sixth layers will be the first repetitions of the first, second, and third layers, we get exactly the face-centred lattices of the regular type built up on the octahedral surface as base. Thus the hexagonal and the face-centred regular lattice form pass into one another by means of a system of regular slidings along the octahedral surface, or, as we may say, by a sort of twin-formation. The face-centred regular lattice, like the double hexagonal lattice, may be regarded as a special form of spherical pile.

Continuing from NaCl we may describe the structure of CaCO_3 in the following way: Let us imagine the NaCl-lattice placed with its space diagonal upright and let us replace Na everywhere by Ca, and Cl by C. Let us then surround each C-atom (cf. Fig. 35) by a wreath of three O-atoms, whose plane is perpendicular to the vertically placed diagonal. As a result of this arrangement of the three O-atoms about the vertical axis, more space, so to speak, is used up in the horizontal plane than in the vertical axis. The original cube, therefore, becomes extended horizontally and becomes a rhombohedron, as is well known from the surfaces of cleavage of fluor-spar. Carbonates and nitrates that are

isomorphic with fluor-spar have the same structure with slightly changed rhombohedral edges.

The structure of zinc-blende may be described as a cubical face-centred lattice of Zn^{++} -ions and a similar lattice of S^{--} -ions, which is displaced with respect to the former by a quarter of a space diagonal. The polar nature of this axis that shows itself in the crystal form of zinc-blende (tetrahedral hemihedrism of the regular system*) and in its physical properties (pyro- and piezo-electricity), exhibits itself strikingly by the uneven occupation of the space-diagonals by Zn- and S-ions. In order not to confuse Fig. 36, we have filled in only the Zn- and S-ions on a diagonal (placed vertically) and have only sketched lightly the edges of the cube of the corresponding Zn- and S-lattices.

From the lattice of zinc-blende we get that of fluor-spar, CaF_2 , by substituting Zn^{++} by Ca^{++} , and S^{--} by F^- and then adding a second ion, F^- , symmetrically on the other side, which is diametral to the first

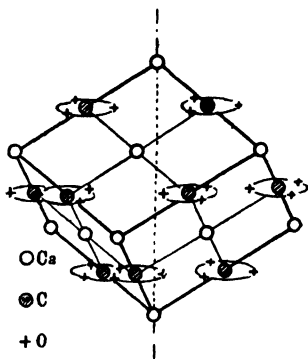

FIG. 35.

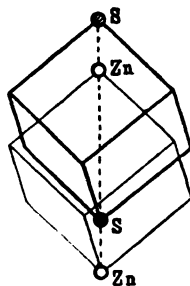

FIG. 36.

F^- . As a consequence of this symmetrical arrangement $F^- Ca^{++} F^-$ of the three-fold axis, its polar character is destroyed.

From zinc-blende we pass on to the *diamond* by replacing both the Zn- and the S-ions by C-atoms. The polar nature of the three-fold axes is thus again destroyed; the symmetry becomes holohedric, which is as it should be for diamond. But further: each C-atom lies at the centre of a regular tetrahedron whose corners are occupied by C-atoms. Cf. Fig. 37 which represents a tetrahedron of this type that has been cut out of the crystal structure. The old chemical idea of the tetrahedron valencies of carbon (van 't Hoff and Le Bel) is thus beautifully confirmed by the crystal model† of diamond. Of course we have had the same relative

* Cf. W. H. Bragg and W. L. Bragg, "X-Rays and Crystal Structure," Bell & Sons, p. 146. This book contains a detailed discussion of the points enumerated in this section. H. L. B.

† Proved by W. H. Bragg and W. L. Bragg, 1913; it was surmised by A. Nold [Chem. Ztg., 29, 174 (1905)] and A. Schönflies (*Vorträge über die kinetische Theorie der Materie*, Göttingen, 1913, Teub. S. 66 der 1. Aufl.).

position of the atoms already in the case of zinc-blende, as its constructed space-model (in contradistinction to our schematic sketch of Fig. 36) immediately shows: in this case, too, each Zn-atom lies at the centre of a tetrahedron of S-atoms and vice versa. The same lattice as that of diamond is possessed by the element Si, which is chemically related to it.

If the diamond model is uniformly stretched in the direction of the three-fold axis, which was placed upright in Fig. 36, we get from the cubical crystal form one that is of rhombohedral symmetry. This form belongs to Bi, Sb, As, the stretching increasing gradually. Since in the new form of symmetry the two face-centred lattices that are interlocked in diamond are no longer determinate but may be slid along the three-fold axis, their distance from one another need no longer, as in the cubical case, amount to a quarter of the principal diagonal; indeed, in the case of Sb, for which it has been determined, it appears to be considerably greater.

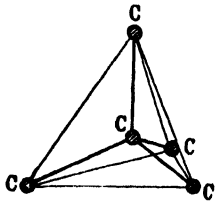

FIG. 37.

The structure of the other modification of carbon, graphite, has also been ascertainable by means of Röntgen rays. Its horizontal planes (base planes, planes of cleavage of graphite) are hexagons that join up with one another as in the case of honeycombs (cf. Fig. 38). The crystal system is rhombohedral (trigonal). In this case, too, the carbon is tetravalent in action. But only the three horizontal valency bonds that connect one of the hexagonal points with three neighbours are equal to one another; the fourth valency bond, directed upwards, which links up the point of the one horizontal plane with a point above or below it on the neighbouring horizontal plane, is much longer and hence much weaker. The exceptional tendency of graphite to cleave along the basal plane is connected with this fact.

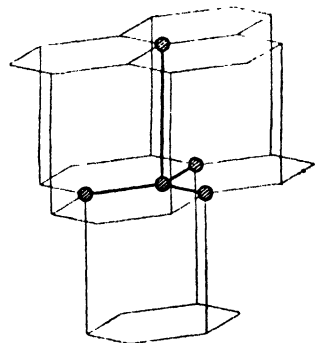

FIG. 38.

We get this graphite lattice from the two face-centred regular component lattices of diamond if we displace these relatively, not as in Fig. 36 by a quarter of the greatest diagonal, but by a *third*. In this reciprocal position the middle C-atom in Fig. 37 moves into the basal plane of the tetrahedron shown, and at the same time the system of tetrahedral diagonals darkened in Fig. 37 passes over into the hexagonal system of axes shown in dark type in Fig. 38. Finally we have yet to stretch the whole lattice uniformly in the direction of the vertical axis without altering the horizontal projections, which are exactly equal in the case of diamond and graphite.

Moreover, so-called amorphous carbon derived from the most varied

sources has shown itself to be micro-crystalline graphite on examination by Röntgen rays. Hence there are only two chemical forms of carbon: the diamond lattice, tetrahedral in structure, being the type of aliphatic combinations of carbon, and the hexagonally constructed graphite lattice, the archetype of all aromatic compounds of carbon (Debye).

By the same process of sliding as that by which we passed from the face-centred lattice of the regular elements to the hexagonal lattices of Zn, Mg, etc., we clearly also get from the two interpenetrating face-centred lattices of diamond to a new lattice of hexagonal structure. The tetrahedral arrangement of atoms is not hereby destroyed; that is, we get a lattice in which, as in diamond, each atom is connected by four valency links with its neighbour atoms. It was natural that, originally, we were inclined to attribute this lattice—we call it “pseudo-graphite lattice”—to graphite. But, although later experimental investigations of graphite disclosed a different lattice system, our pseudo-graphite lattice seems very probably to belong to a second modification of ZnS, namely, wurtzite; it has been shown with certainty to exist in the case of ZnO, red zincite.

Of the other dimorphic crystals TiO_2 has been examined in the form of anatase and rutile: both are tetragonal but their axial ratios differ and likewise their lattice structures.

The knowledge of a great number of other crystals is so far incomplete, that is, only the position of individual atomic groups and the lattice distance of their crystallographic basal form is known. Among these are ice, quartz, sulphur, and the crystals of the aluminium group.

Figures and references about the lattices above described are added in note 3 at the end of the book.*

§ 3. Methods of Measuring Wave-lengths †

Whereas in the first paragraph we have discussed the diffraction by lattices exclusively from Laue's point of view, we shall now pass on to that of W. H. and W. L. Bragg. For this purpose, we prove the following theorems:—

1. The median plane MM between the incident ray ($\alpha_0\beta_0\gamma_0$) and the diffracted ray ($\alpha\beta\gamma$) is a *net plane* of the crystal, that is, a plane that cuts an infinite net of points out of the crystal lattice, and may therefore be regarded as a possible crystallographic boundary surface.

2. The diffracted rays may be regarded as being generated by a reflection at this net plane.

In proving 1, we restrict ourselves, as in the first section, to the regular system.

* Cf. also, besides the book by W. H. and W. L. Bragg, the consecutive account in the *Zeitschrift für Kristallographie*, edited by P. Niggli, particularly the concluding sections of each issue since 1921.

† The experimental methods of Röntgen ray spectroscopy have been enumerated in detail by F. Wagner, *Physikal. Zeitschr.*, 18 Jahrg., 1917, p. 405, and M. Siegbahn, *Jahrb. d. Radioaktivität u. Elektronik*, 13, 296 (1916).

In Fig. 30, above, let the distances

$$OP = OQ = 1.$$

If we choose O as the origin of a rectangular system of co-ordinates, which coincides with the crystal axes, then the co-ordinates

of P are $\alpha_0\beta_0\gamma_0$, and of Q are $\alpha\beta\gamma$.

Let the co-ordinates of any point M in the median plane be x, y, z . The median plane is the geometrical locus of equal distances, $PM = QM$. Thus its equation is :

$$(x - \alpha_0)^2 + (y - \beta_0)^2 + (z - \gamma_0)^2 = (x - \alpha)^2 + (y - \beta)^2 + (z - \gamma)^2$$

or, after reduction,

$$(\alpha - \alpha_0)x + (\beta - \beta_0)y + (\gamma - \gamma_0)z = 0.$$

If we insert into this the interference conditions (3) of § 1, we get

$$h_1x + h_2y + h_3z = 0 \quad (1)$$

Let n be some common division of the order numbers h_1, h_2, h_3 , that is

$$h_1 = nh_1^*, \quad h_2 = nh_2^*, \quad h_3 = nh_3^* \quad (2)$$

whereby h_1^*, h_2^*, h_3^* have no common factor. Equation (1) then states that a plane that is parallel to MM has intercepts on the crystallographic axes that are inversely proportional to the integers h_1^*, h_2^*, h_3^* , which are prime to one another. The numbers h_1^*, h_2^*, h_3^* are called the *indices of the surface* MM. The fundamental law of crystallography, the "law of rational indices" states that every surface that has integral indices is a possible surface of a crystal. (As in the case of all physical laws in which rational ratios occur, rational indices denote such as are representable by the ratios of *small* integers.) From the point of view of the lattice idea, this law is self-evident. It states nothing else than that every boundary surface of a crystal is occupied by a full net of lattice-points.

We have thus seen that *the median plane MM between the incident and the diffracted ray is a net plane of the crystal: the order numbers h_1, h_2, h_3 of the interference phenomenon determine simultaneously the indices h_1^*, h_2^*, h_3^* of this net plane.*

The incident and the diffracted ray make equal angles with this plane, namely, the angle θ in Fig. 30. Thus there is nothing to prevent us from interpreting the phenomenon of diffraction as a reflection at this net plane. This is, however, *not surface reflection*, but *space reflection*. On the one hand, it is not necessary that the reflecting net plane of the crystal be a bounding plane of it: the reflection takes place just as well at the inner virtual crystal planes as at the external real ones. On the other hand, the whole system of parallel net planes reflects concurrently with the individual plane MM. As we saw in the first section, all lattice-

points on which the primary ray impinges contribute to the interference phenomenon. The lattice-points contained in the individual net planes would furnish only a vanishing fraction of the whole intensity. Even in the particular case in which MM is a bounding surface of the crystal, the intensity does not depend on the quality of the surface, as is the case in optical surface reflection; we may roughen the boundary surface without thereby making the reflection weaker or more diffuse. Thus *the reflected intensity is derived from the interior of the crystal.*

But, further, we are here dealing not with a general reflection of all wave-lengths, but with a selective reflection of certain favoured wave-lengths. "White light" is not reflected back as white light, as occurs in optics, but reappears "coloured" (we are applying the language of optics here, as on p. 119, to Röntgen light). Whereas all other wave-lengths remain appreciably united in the primary ray, and traverse the crystal in a straight line, certain wave-lengths, of appropriate length for the lattice structure, are selected by the reflection. This selective colour of interference rays has already been met with in the first section.

Let OA, OQ be the incident and reflected rays at the lattice-point A, and let PC, CR be the incident and reflected rays at the lattice-point C, which is situated in the plane parallel and adjacent to MM. The difference between the lengths of path of both sets of rays is found by dropping from A the perpendiculars AB and AD on to PC and CR. The difference of path is, if d denotes the distance AC between the net planes,

$$BC + CD = 2d \sin \theta.$$

This must be a whole multiple of λ if the two reflected rays AQ and CR are to be in phase and are to strengthen one another by interference. This gives us the fundamental relation

$$2d \sin \theta = n\lambda \quad \dots \dots \dots (3)$$

But in deriving this relation we have made an unnecessary specialisation. It is not necessary that the two lattice-points A and C, in Fig. 39, which are being compared, lie directly behind one another, that is, on the same normal to MM as we found it convenient to assume for the sake of simplicity in the figure. Rather, we may displace the point C arbitrarily in its net plane to C'. The course of the rays P'C'R' (dotted in Fig. 39) clearly has the same optical length as the course PCR, provided that the two points PP' and RR' are assumed, in particular, to lie on a wave plane through the incident and reflected ray, respectively. This is shown clearly in Fig. 40, in which the points RR' are placed still more specially, namely, symmetrically to PP' with respect to the plane of symmetry SS there drawn; this has no effect on the phase-difference at R and R'. We see that the optical paths PCR and R'C'P' are images of one another. If the two rays incident at P and P' are in phase, then also the two reflected rays at R and R' will be in phase. But then it

follows from Fig. 39 that in it, too, there is the same difference of path between the reflected rays $C'R'$ and AQ as between CR and AQ , namely, the difference $n\lambda$; the former strengthen one another by interference just as much as the latter.

In fact, generally, any two lattice-points of the crystal, no matter whether they lie on two neighbouring net planes or on two net planes that are distant from one another by various multiples of d , no matter whether they lie in the plane of incidence (that of the page) or not, will strengthen one another by interference, provided only that the wave-length and the angle of incidence are related to one another by the condition postulated in (3). It is not even necessary for the points CC' . . . to be arranged in lattice form, that is, equidistantly, within their net plane. What is important for reflection at the system of planes MM is merely the regular sequence of these planes, not the regular sequence of points within a plane of the system. The latter factor comes into account only when we wish to change the reflection plane, that is, when the crystal, besides reflecting from the system of planes MM , is also to reflect from other net planes running through the crystal.

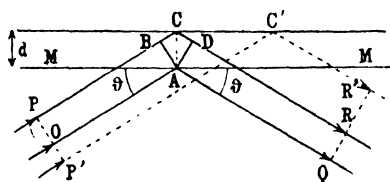

FIG. 39.

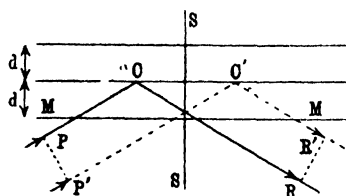

FIG. 40.

For this, that is, for the existence of further net planes and for their action by interference, the necessary condition is that the lattice-points be regularly arranged in the first system of net planes.

In optics we are familiar with the process of O. Wiener, in which, by means of stationary waves, silver particles are precipitated in parallel equidistant planes in a layer of silver chloride. The silver particles succeed each other irregularly within each plane, but the planes succeed each other regularly at a distance equal to half that between two crests of the stationary light, that is, equal to half the wave-length of the monochromatic light used. These strata of Wiener have been used, as we know, in Lippmann's process of photography in natural colours. Here we have the case assumed above of a regularly stratified system of planes, which, for their part, are irregularly occupied by silver granules. In interpreting such phenomena our equation (3) played a part,* long before its importance in the realm of Röntgen rays could be surmised in any way.

Of course this equation must be identical with the formulæ (9) and

* In the theory of W. Zenker. Cf. his *Lehrbuch der Photochromie*, Berlin, 1868.

(11) for the wave-length. In fact, on the view that the quantities h_1^* , h_2^* , h_3^* are surface indices we see by a simple geometrical argument that the distance d between two successive planes of the group parallel to MM is given in the cubic and the rhombic system, respectively, by

$$\frac{1}{d} = \frac{1}{a} \sqrt{h_1^{*2} + h_2^{*2} + h_3^{*2}}, \quad \frac{1}{d} = \sqrt{\frac{h_1^{*2}}{a^2} + \frac{h_2^{*2}}{b^2} + \frac{h_3^{*2}}{c^2}} \quad (4)$$

If, taking account of (2), we introduce these values into (9) and (11) of the first section, both these equations resolve into our present equation (3). We see from the method by which it has now been derived, that it is not confined to the case of the regular system but is generally valid. The meaning, too, of the integral number n introduced in equation (2) (it is the greatest common factor of the order numbers h_1 , h_2 , h_3 of the interference effect) is now also intelligible physically: n denotes the order number of the reflection phenomenon, that is, the number of wave-lengths by which each reflected ray differs from its neighbouring rays that are reflected from the next or the preceding net plane.

For a given angle of reflection θ and given distance d between the net planes, equation (3) determines one and only one quite definite wave-length, λ_1 of the first order (for $n = 1$) that is capable of reflection, and likewise one of the second, third, . . . order, $\lambda_2 = \frac{\lambda_1}{2}$, $\lambda_3 = \frac{\lambda_1}{3}$, . . . (for $n = 2, 3 \dots$). Hence if we wish to reflect the whole spectrum from one and the same crystal surface, for example, in the first order, then θ must be made variable. For the short-wave side of the spectrum, θ is to be chosen small, for the long-wave side it must be chosen correspondingly great. This consideration leads us on directly to the **method of revolving crystals**, which in the hands of W. H. and W. L. Bragg* has led to brilliant results, and, indeed, in the two directions characterised on page 121, the analysis of Röntgen rays by means of crystals, and the analysis of crystal structure by Röntgen rays.

Fig. 41 gives a schematic horizontal section of the arrangement of apparatus in the method of revolving crystals. At the top the Röntgen tube is indicated by its cathode K and its anti-cathode A. The slit S_1 in a

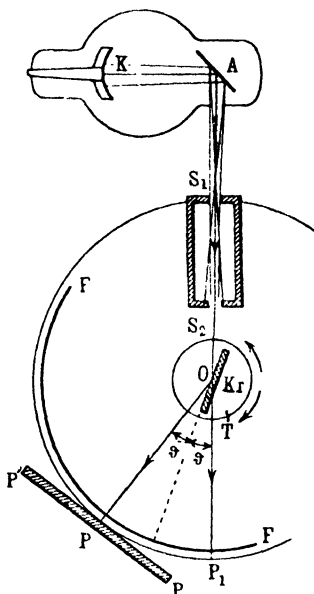

FIG. 41.

* They used the ionisation method (see below). De Broglie first used the revolving crystal method for taking photographs.

lead plate singles out from the rays emitted from the focus of the anticathode a narrow beam of rays. S_2 is a second small slit of lead, which serves to limit the pencil of rays still further. This beam then falls on the crystal Kr , which is set up on a table T , carrying vernier divisions, in such a way that the front reflecting net plane of the crystal (for example, a cleavage plane of rock-salt) passes through the vertical axis of rotation O of the vernier table. The latter is slowly turned about the axis O within a certain range of angles. All wave-lengths of a certain range of wave-lengths then impinge on the table successively at the necessary angle of incidence θ (or "glancing angle") and are separated spectrally by the reflection. They delineate themselves sharply on the photographic film FF' , which is best fixed (see below) along the circle S_1PP_1 that passes through S_1 ; for a small range of angles, it may also be replaced by the plane photographic plate $F'P'$. Now, P_1 is the locus of the film, at which is marked the primary radiation of the Röntgen tube that has traversed the crystal without reflection; there follow consecutively on the film the shortest wave-lengths contained in the primary beam of X-rays, and then the longer ones. The longest wave-length which, according to equation (3), may be reflected by a crystal with a given distance d between the net planes is $\lambda = 2d$; the corresponding angle $\theta = \frac{\pi}{2}$. The locus or track of the wave-length on the film would coincide with S_1 . It is obvious that this maximum wave-length can be reflected only in the first order ($n = 1$).

The scale of the λ 's appears distorted in a certain way not only on the plane plate $P'P'$ but also on the film that is fixed circularly. If P is the spot at which a certain wave-length λ leaves its mark, then the distance P_1P that is measured on the unrolled film is proportional to 2θ , whereas λ itself, according to (3), is proportional to $\sin \theta$. Hence the X-ray spectrum so obtained is drawn according to scale and in its natural proportions only for small values of θ (hard wave-lengths). As θ increases, the dispersion of this spectral picture increases more and more rapidly and finally becomes infinitely great for $\theta = \frac{\pi}{2}$. For, by equation (3), we get that, for two wave-lengths λ and $\lambda + d\lambda$ that differ by very little, and their corresponding angles 2θ and $2(\theta + d\theta)$,

$$\frac{d\theta}{d\lambda} = \frac{n}{2d \cos \theta} = \infty \text{ for } \theta = \frac{\pi}{2} \quad . \quad . \quad . \quad (5)$$

Hence if we wish to resolve a part of the spectrum very sharply (for example, the region of a line-doublet), we must look for a crystal that reflects the region of wave-lengths in question at the greatest possible angle θ . By equation (3), this is a crystal with $d = \frac{n\lambda}{2}$ for the reflection of the n^{th} order. Only for comparatively great λ 's ($\lambda > 10^{-8}$ cms.) will it

be possible to realise this condition in the first order; for smaller λ 's we should have to carry out the measurements in an appropriate higher order.

At the same time, equation (5) shows that the revolution of neighbouring wave-lengths in the photographic picture increases with the magnitude of the order number n , as has already been pointed out in the first section for the case of the optical diffraction grating, and as will become manifest in the specimens of spectral photographs of Fig. 44. As an actual fact narrow doublets are often measured in the second order and occasionally even in the fourth or fifth* order. The advantage of greater resolution is, however, counterbalanced by the disadvantage of diminished intensity. Fig. 44 gives a clear picture of this, too.

We have yet to mention several refinements of the method of the revolving crystal. Among these is the elimination of the *faults of the crystal*. Even a naturally grown crystal surface, or one that is carefully prepared by cleavage is not free from faults and local irregularities. If we use a crystal that is fixed in position, then every ray and every wave-length of the incident pencil of rays will be reflected at only one point of the crystal, and the faults of the crystal at this spot will have their full effect and will betray themselves by fogging the continuous spectrum or by distorting the rectilinear course of the line-spectrum, as actually took place in the older photographs, in which the crystal was kept fixed. On the other hand, in the case of the *revolving* crystal, in which the ray glides along over the crystal surface and finds in each position of the crystal the appropriate angle of reflection θ for each wave-length in question, the faults neutralise one another (cf. Fig. 42).

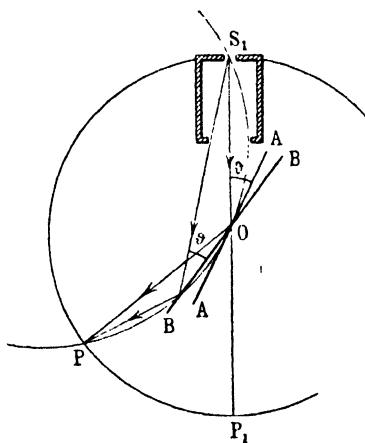

FIG. 42.

Let the position AA of the crystal be chosen so that the central ray of the pencil escaping through the lead slit S falls on to the middle O of the crystal at the correct angle θ for the wave-length λ under consideration. We describe the circle S_1OBP through S_1 , which touches the line AA. Every point B of this circle is the apex of an angle at the circumference, standing on the arc S_1O , and all these angles $S_1BO = \theta$. Draw BOB; by doing this, we obtain a new orientation of the crystal, in which the same wave-length λ of the ray S_1B is reflected at the spot B of the crystal surface. By continuously turning the crystal from the position AA to the position BB, the point of reflection glides continuously from O to B along

* Cf., for example, Duane and Steurom, Phys. Rev., 15, 329 1920).

the crystal. This gliding motion ceases only at the boundary of the crystal surface or at the boundary of the incident pencil of rays.

Our Fig. 42 exhibits a further advantage of the method, namely, its power to *focus the reflected rays of the same wave-length at one point*. Let P be the point at which the ray reflected at O meets the circle S_1OB . Then $S_1OP = \pi - 2\theta$ is the angle subtended by the arc S_1P at the circumference. Thus the angle $S_1BP = \pi - 2\theta$, too, since it stands on the same arc. From this it follows, if we suppose the reflecting crystal plate in the position BB at which the ray S_1B is incident at the angle θ , that BP is likewise inclined at an angle θ to BB, and thus represents the reflected ray. Hence, while the ray glides along the revolving crystal plate in the process of reflection, it always passes through P: all rays with the same λ are focussed at P. If we pass on to consider a different λ , the position AA of the crystal plate, for which this λ is reflected at O, will indeed change, as also the circle S_1OP and the position of P. But the distance $OP = OS_1$ will remain fixed. Hence each successive focus P will lie on the fixed circle with its centre at O and with the radius OS_1 . We thus get a *sharply defined photographic picture of the whole extent of the spectrum if we bend the film*, as was depicted in Fig. 41, so that it lies along the circle described about O as centre with the radius OS_1 , that is along the circle S_1PP_1 of Figs. 41 and 42.

The sharp definition of the photograph is, on the other hand, reduced by the circumstance that the revolving crystal averages over the crystal faults of the region of surface used in the reflection. To counteract this, the sharpness of the lines is increased by allowing the radiation to fall on a minimum portion of the surface. This is secured if a carefully selected good part of the crystal is narrowed off by a slit that is fixed close to the surface of the crystal. Thus the ideal arrangement (which is, however, as we shall see below, possible only in the case of comparatively soft rays) would be a revolving crystal, of which only a very small part, free from imperfections, was used. The consequent loss of intensity may be balanced by lengthening the time of exposure. Whether the crystal is turned continuously by clockwork or, in stages, by hand, is of no consequence: nor does it matter whether the crystal is turned with respect to the X-ray bulb or vice versa. Seemann and Friedrich* produce the slit that is to be fixed just in front of the crystal surface by bringing a metal edge close up to the latter; the other side of the slit is furnished by the crystal itself.

In the case of *hard rays* the revolving crystal must be rejected, and we use, instead of the rays reflected at the surface, transmitted rays. For, on account of the depth of penetration of hard rays, the resulting deep position of the system of reflecting layers would bring about a broadening of the lines that would make impossible an accurate measure-

* Physikal. Zeitschr., 20, 55 (1919).

ment of the angle of incidence. In the case of transmitted Röntgen light, the reflecting layers are inner net planes which, at least in the case of regular crystals, lie perpendicularly to the surface. The slit must then be fixed *behind* the crystal plate. It marks off the emergent pencil and sharply defines the angle of reflection. A similar method has been used by Rutherford and Andrade* for analysing γ -rays (see § 6 of this chapter). It has been converted into a precision method by Siegbahn.† The different angles of incidence that are requisite for the reflection of different wave-lengths must be furnished by adjusting the aperture of the incident pencil of rays. In spite of the absence of rotation, extremely sharp lines are obtained, provided that the slit is sufficiently narrow. The correct position of the lines cannot be checked from an individual photograph, but is secured in the precision measurements of Siegbahn (see § 5 of this chapter) by the simple artifice of comparing with one another two photographs taken in two positions of the crystal that are symmetrical with respect to the direction of the ray.

If very soft rays, which are strongly absorbed in several centimetres of air at atmospheric pressure, are to be photographed, the whole course of the rays must lie *in vacuo*. This requirement leads to the construction of vacuum spectrographs, which have been developed by Siegbahn along the lines of Moseley. The whole apparatus (see Fig. 41) from the circle $S_1 P P_1$ up to and including the plate $P' P'$ has for this reason been enclosed in a brass case connected with an air-pump. The X-ray tube is also to be considered in this figure as connected with this brass case by a tube S_1 that may be evacuated.

We now proceed to discuss two other methods of X-ray spectroscopy, the first being the ionisation method of W. H. Bragg. In it the photographic plate or film is replaced by an ionisation chamber, that is, by a vessel that is filled with a (preferably heavy) gas, which receives the reflected radiation at P (Fig. 41). The gaseous content becomes conducting (ionised) in proportion to the radiation absorbed; the conductivity is measured by electrometers. The ionisation chamber must be turned, step by step, along the circle $P_1 P S$ of Fig. 41 to the same extent as the crystal is turned forward, step by step, when we pass from one wave-length of the spectrum to another that is neighbouring to it. Thus, in this case, the spectrum is represented not by a continuous distribution of darkened spots, but by a discontinuous succession of electrometer deflections. The method has its advantage in measuring the intensities in the X-ray spectrum, and, through the use of electrometers, it is specially sensitive and allows quantitative comparisons (on account of the approximate proportionality between X-ray intensity and ionisation). The method has been so far perfected, particularly by L. Webster and W.

* Rutherford and Andrade, *Phil. Mag.*, **28**, 263 (1914).

† Siegbahn and Jönsson, *Physikal. Zeitschr.*, **20**, 251 (1919).

Duane, that it can compete with the photographic method of measuring wave-lengths.

Secondly, in the method of crystal powders, devised by Debye and Scherrer, the various angles of incidence that are requisite for the various wave-lengths of the spectrum are furnished by the natural lack of order in the crystal powder. The same method has been developed in America by A. W. Hull. It is a typical example of the inevitableness of scientific development that, in spite of the blockade due to the war, the same idea sprang up almost simultaneously in Germany and America. A narrow pencil of Röntgen rays falls into a little tube which is filled with a micro-crystalline powder, and strikes one and the same crystal surface in all possible orientations. For each wave-length there are crystal surfaces inclined at the correct angles, and indeed in all positions around the direction of the incident ray. Hence, the reflected radiation forms for each wave-length a cone about the incident ray. A circularly cylindrical

film placed in position, will be darkened by the reflected radiation at its curve of intersection with this cone. If the primary ray travels along horizontally, the mantle (sheet) of the cylindrical film is placed vertically. The arrangement is particularly simple and has already been of great service to crystal analysis, since most minerals occur more often in the powder form, so-called

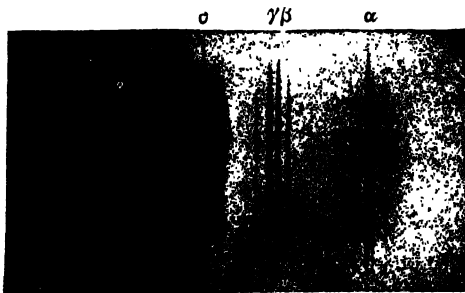

d
FIG. 43.

amorphous form, than in that of well-grown crystals; if necessary, the fineness of the granules may be increased artificially. For the purposes of true X-ray analysis, however, this method hardly comes into question.

We now give an indication of the power of X-ray spectroscopy by reproducing some typical photographs. Fig. 43 is the spectrum of a tube with a platinum anti-cathode, photographed from a revolving crystal of rock-salt: the picture is magnified four times in the reproduction. The wave-lengths increase from left to right. On the less exposed right side of the figure the characteristic lines of platinum (so-called L-series, denoted by $\alpha\beta\gamma\delta$) stand out very conspicuously as straight lines, accompanied by several weaker lines of iridium, that is related to platinum, and several mercury lines. On the left side of the figure, which was exposed to the reflected rays more often owing to the manner of adjustment of the crystal, and was therefore darkened relatively more than the background of the right side of the picture, we see the *continuous spectrum* depicted as a fairly uniformly darkened field. The intensity of the darkness decreases at the point marked *d* ("bromine band," cf. § 7 of this chapter)

in a strikingly sudden way towards the right, owing to the selective sensitivity of the photographic layer of silver for X-rays. Hence we here get a document which gives the two components of X-rays, often mentioned above, namely the continuous spectrum and the line-spectrum (impulse radiation).

The next picture is one of a series of systematic photographs by means of which W. H. and W. L. Bragg have unravelled the structure of rock-salt (Fig. 44). The source of radiation was a tube with a rhodium anti-cathode. This gives, in addition to a weak continuous spectrum, two lines in particular, one, the more intense but softer α -line, and the other, the weaker but harder β -line of the so-called K-series. The cube surface of rock-salt served as the reflecting crystal surface. The intensity of reflection was measured by the ionisation method. The ordinates of the figure are thus electrometer deflections giving the intensity of the ionisation current; the abscissæ denote the angles 2θ (cf. Fig. 41), through which the ionisation chamber must be turned so as to be able to receive the reflected intensity under consideration in turn. The figure shows the two lines α and β in three different positions. The difference between

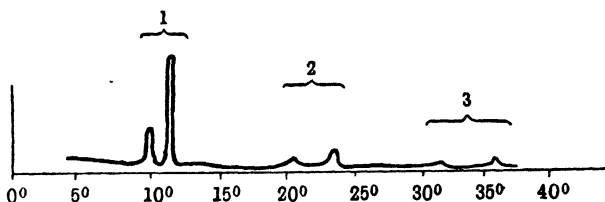

FIG. 44.

the lines, which gives a measure of the spectroscopic resolution, increases with the order-number of the reflection; at the same time, however, the intensity of the lines rapidly decreases (the amount of this decrease depends not only on the general conditions of the diffraction, but also on the particular structure of the crystal used). Both facts, increase of resolution and decrease of intensity, have already been emphasised above. In addition to the line-spectrum, the continuous background appears faintly. The sharpness of the lines, compared with the preceding photograph, is by no means great in this ionisation picture.

We give as our third picture a photograph,* taken by Debye and Scherrer, of very finely powdered LiF . The source of radiation, a tube with a Cu-anti-cathode, again emits, in particular, two characteristic wave-lengths, the α - and the β -line of the K-series, the former being a little more intense than the latter. The dark lines of the photograph are produced by these two wave-lengths, whereas the continuous spectrum of the Cu-tube has produced no appreciable darkening. These dark lines are, as we remarked above, the intersections of the film with the circular

* Taken from the Göttinger Nachrichten of the year 1916.

cones that start out from the crystal powder, and are described about the direction axis of the incident X-ray pencil. In the middle of the picture the lines of darkness are straight, because the circular cone that is described about the primary ray becomes a plane when its angle of aperture is 90° , and it therefore intersects the films in a straight line. Towards the right and the left ends of the picture (emergent and incident directions of the primary ray) the curvature of the lines of intersection increases. The very dark lines correspond throughout to the α -line of Cu, likewise the moderately dark ones; the weak lines correspond to the β -line, in the main. The α -radiation and likewise the β -radiation gives us not only one, but several dark images, because it is reflected appreciably at several surfaces of the micro-crystals (octahedral, dodecahedral, cubic surface, and, indeed, not only in the first order, but also in the second, third, and fourth orders), whereby these surfaces must in each case have the appropriate orientation towards the incident Röntgen light. This photograph, like all obtained by this method, serves the purpose of discovering the crystal form and crystal structure of the crystal powder which is traversed by rays, and which cannot be measured out in any other way.

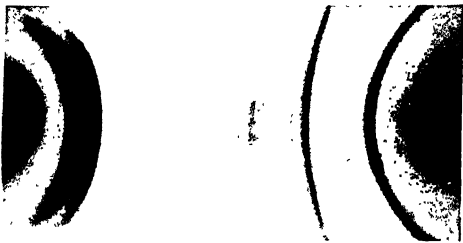

Fig. 45.

But as it also allows us to recognise the composition of the Röntgen radiation used, it is related to the proper methods of X-ray spectroscopy above described.

But we must now follow the purpose stated in the title of this section—the *measurement* of the wave-length of Röntgen rays. This depends,

as is clear from equation (3) and from Laue's own fundamental idea, on a comparison of the wave-length sought with the dimensions of the crystal lattice, in particular, with the distance d between the net planes.

Let us return to the method of the revolving crystal and assume that a number of lines are photographed very distinctly and sharply on the film FF of Fig. 41. The distance of an individual line from the primary ray gives us the angle 2θ directly (cf. Fig. 41). From this we calculate θ and $\sin \theta$. Thus, so long as d is known, λ can also be given directly from (3). We find λ to be of the order of magnitude 10^{-8} cms.

It only remains for us to describe how d is found.* To do this, we must refer to the remarks in the preceding paragraph about the construction of crystals from their atoms. Very careful measurements are made of the cube-surfaces by using a piece of rock-salt that has been obtained by cleavage. For such a piece (cf. Fig. 34) $d = \frac{a}{2}$, that is, equals half

* Cf. the detailed discussion by E. Wagner, Ann. d. Phys., **49**, 625 (1916).

the edge of the cube, in which Na-ions, on the one hand, and Cl-ions on the other, are arranged. In each cube plane we have a quadratic net, the distance between the meshes of which is $\frac{a}{2}$, and which is formed alternately by Na- and Cl-ions. The neighbouring net plane is at a distance $d = \frac{a}{2}$ from this one, and is occupied by the same net, whereby, however, a Cl-ion is situated directly above an Na-ion and vice versa. If we imagine a cube d^3 described about each Na- and Cl-ion as centre, then these cubes completely fill the crystal. Hence, in the space $2d^3$ there will be a mass $m_{Na} + m_{Cl}$. This mass amounts to

$$(23.00 + 35.46)m_H = \frac{58.46}{L} = \frac{58.46}{6.06} \cdot 10^{-23},$$

that is, the sum of the atomic weights of Na and Cl multiplied by the mass m_H of the hydrogen atom, or, more accurately,* with the reciprocal of L , Loschmidt's number per mol, the value of which we get from Fig. 1B on page 7.

We get in this way, for the density of mass of rock-salt,

$$\rho = \frac{58.46}{6.06} \cdot 10^{-23}$$

This density of mass is, on the other hand, known from direct observation, or can be determined experimentally for the crystal of rock-salt used in each particular case. A very exact measurement by Röntgen gives

$$\rho = 2.164.$$

By comparing the two values of ρ we find

$$d = \sqrt[3]{\frac{58.46 \cdot 10^{-23}}{2 \cdot 2.164 \cdot 6.06}} = 2.814 \cdot 10^{-8} \text{ cms.}$$

The most uncertain value of those used is Loschmidt's number, the error

* As we are here dealing with an experimentally precise determination of d , which will affect the accuracy of all later data about wave-lengths, the following circumstance must be emphasised. Our atomic weights, as we know, are referred to 0 = 16; the atomic weight of hydrogen then becomes not 1, but 1.008. When we set

the electrochemical equivalent charge of the mol, 9649.4 in Chapter I, § 2, equal to $\frac{e}{m_H}$, we intended m_H to signify, not the mass of a real hydrogen atom, but the mass of an imaginary atom, which would be exactly units in our table of atomic weights. We shall distinguish the true hydrogen atom by the symbol m_H^* from the imagined hydrogen atom m_H . The two are related by: $m_H^* = 1.008 \cdot m_H$. Loschmidt's number L , which refers to the mol of exactly 1 grm., is not equal to $\frac{1}{m_H^*}$, but to $\frac{1}{m_H}$. In the text above, too, as well as throughout Chapter I, m_H is to be taken as standing for the imagined hydrogen atom, and not for the real m_H^* . Only when we get to Chapter IV, in which we deal with the spectrum of real hydrogen, will the real mass m_H^* of the hydrogen atom first come into question.

in which is at most 1 per cent ; as a result, the limit of error which may be imputed to the value of the lattice constant d is less than $\frac{1}{3}$ per cent.

The value $d = 2.814$ was used in the first determinations of wave-lengths by Moseley (1913), and has served for most of the later investigations, in particular for those of Siegbahn, as the standard value for calculating the wave-lengths λ from the measured angle θ . If we carry out our observations, not with rock-salt, but with another crystal of, say, even an unknown structure (gypsum, mica, Prussian blue), it is sufficient to compare a wave-length in both scales, so as to be able to refer the lattice constant d of the new crystal to that of rock-salt, and hence to be able to calculate the wave-lengths from the measured angles θ without incurring new errors.

The use of a standard lattice constant is indispensable for absolute measurements, as was pointed out in particular by E. Wagner.* Whether the lattice constant is exactly known is only of secondary importance. The main thing is that all measurements must be referred to the same lattice constant. The conventional character of the " d " of rock-salt is clearly recognisable from the circumstance that, in the more recent work which has been done in Siegbahn's laboratory, d has been given the numerical value 2.81400, and this is the value used in calculations ; it is thus not a result of measurement, but an ideal value that has been fixed by convention. Of course, it may be found convenient to pass from rock-salt to calc spar, $d = 3.029$ (or $\bar{d} = 3.02900$), which is more appropriate on account of its crystalline constitution. But this, too, could not be done for an individual case, but would have to be agreed upon generally by convention.

§ 4. Survey of the K-, L-, and M-series and the Corresponding Limits of Excitation

We now enter into a region of physical research which was founded only in 1913 and which, in spite of the unfavourable conditions of the intervening years, has already been developed so far that to-day its structure is exposed to our gaze with greater clearness and harmony of detail than the regions which have been explored much longer and from which the new researches have borrowed their aims and methods. It is in fact true that the *spectroscopy of Röntgen rays* shows in many ways simpler and more satisfactory results than the illimitable *spectroscopy of the visible region*.

The reason for this striking fact was touched on at the end of the preceding chapter: the X-rays came from the inner part of the atom where the electrons, owing to the influence of the unweakened nuclear charge, obey simple laws: visible spectra start out from the periphery of the atom, where the electrons accumulate and the nuclear charge loses

* Ann. d. Phys., 49, 646 (1916).

its regulative power. A further reason must be added: right from the outset X-ray spectroscopy had the new atomic theory of Bohr (1913) to guide it and direct it, whereas optical spectroscopy was for decades without theoretical guidance and had first to generate from within, as it were, the facts on which the atomic theory could be founded.

Let us next cast a glance at our knowledge of Röntgen radiation before Laue's discovery, that is at the *characteristic radiation of the elements*. Barkla, whose works are almost the only ones that come into account for this question, showed that every element, on to which cathode rays or X-rays are allowed to fall, emits characteristic primary or secondary Röntgen rays of quite definite hardness. The hardness was measured by noting the coefficient of absorption of the radiation in the case of, say, aluminium. The simplicity of the law of absorption led to the conclusion that characteristic X-rays must to a great extent be *homogeneous*. Moreover, it was found that there is a simple relation between the hardness of radiation and the atomic weight of the element emitting it. The hardness increases (that is, the absorption decreases) as the atomic weight increases. In the case of compounds, the characteristic radiation emitted was found to be the sum of the characteristic radiations of the elements constituting the compound. This proved that the characteristic part of the Röntgen radiation was a fundamental property of the atom and that it was conditioned by the atomic weight.

Barkla succeeded in showing the existence of two series of characteristic radiation which, he called the *K-series* and the *L-series*. He observed the K-series of rays in the case of the lighter metals (as far as Ag) and the L-series in that of heavy metals (e.g. Au, Pt). The extrapolation of the observed L-rays for the case of the light elements made it evident that they would be so soft that, with the means at that time available, their presence could not be detected. For it is a general law of the excitation of a characteristic radiation that the *exciting radiation must be harder than that which is excited*. (Hence, if the characteristic X-ray radiation is produced as a secondary radiation by means of a primary one, the latter must be harder than the former. If it is produced as primary Röntgen radiation by cathode rays, the latter must exceed a certain limit of hardness, that is, of velocity, here.) This law of excitation pointed to an analogy in the realm of optics, namely to *Stokes' rule for light produced by fluorescence*. If a fluorescent substance is to be made to fluoresce, the incident light must in general be of shorter wave-length than that of the light emitted by fluorescence. In this case, too, then, the exciting light must be "harder" than that which is excited. Hence Barkla also called characteristic X-rays *fluorescent light*, thus characterising their origin fittingly. Just as the fluorescence light is determined by the nature of the fluorescent body and is different in nature from the exciting light, so the fluorescence X-ray light is determined by the structure of the emitting atom, independently of the constitution of the exciting radiation, provided that the latter is sufficiently hard.

After Laue's discovery all these relations became incomparably more certain and definite. The qualitative measurement of hardness by means of *absorption* was replaced by the quantitative measurement of *wave-length*, which was free from all arbitrariness. The *homogeneity* of the characteristic radiation was on the one hand sharpened and on the other narrowed down. The spectroscopic resolution of the characteristic radiation disclosed a spectrum of sharp lines, of which each, taken alone, represents Röntgen light of very great homogeneity, but the totality of which signifies an emission of light of a certain degree of heterogeneity. The general dependence of the hardness on the atomic weight could now, after the arbitrary mode of measurement by absorption had been replaced by the natural method of measuring wave-lengths, and after, thanks to Bohr's theory, the somewhat indefinite atomic weight had been replaced by the simpler quantity, atomic number, be expressed as a *simple numerical law between wave-length and atomic number*. It also became possible to express *the condition of excitation* quantitatively. When the exciting radiation was resolved spectroscopically, it was seen by how much its short-wave end had to exceed the excited radiation in hardness, in the sense of Stokes' rule. Finally, it became possible to add to the two characteristic emissions of Barkla, the K- and L-radiations, still a third which was appropriately called M-radiation.

We next give a general graphical survey of the wave-lengths of K-, L-, and M-radiation, which is derived from an account given by M. Siegbahn, the discoverer of M-rays (Fig. 46). We mark off the wave-lengths horizontally, whereas vertically, starting from the top, we measure off the increasing atomic numbers of the elements emitting these wave-lengths. The horizontal line thus signifies in a certain sense the extent of the spectrum in question, and the vertical direction, in steps of 3 units at a time, the series of the natural system of the elements. The K-radiation is the hardest of the three types of rays; it has been observed for cases ranging from the lightest elements (Na, $Z = 11$), for which even the K-radiation is already somewhat soft, to cases for which the rays are extremely hard (for example, this was carried out with particular accuracy for tungsten, $Z = 74$). The L-radiation is, for one and the same element, considerably softer than the K-radiation; it has been observed for Cu, $Z = 29$, for which it is still a little softer than the K-radiation of Na. The L-radiation has been drawn in the figure as far as Bi, $Z = 83$. It has been measured beyond this as far as the heaviest element U, $Z = 92$. Still softer than the L-radiation there is the M-radiation, which has so far been observed only in the case of the heaviest elements, and even then special precautions (vacuum spectrograph, cf. p. 135) were rendered necessary. Each of these three types of radiation consists, as the figure indicates, of several lines; as the atomic number increases, each type becomes harder.

To this survey of the experimental results we shall immediately add

the theoretical picture to which the harmonious combination of experimental results has led. To develop it fully we should certainly require a rather lengthy introduction, which we shall give later. Consequently, we shall here restrict ourselves to the more pictorial features of the theory, and shall for the present omit the foundations and the numerical details.

The theory of Röntgen spectra rests entirely on the atomic model which was developed in the preceding chapter. This model was composed of the positive nucleus as the central body and the planetary system of electrons surrounding it. Concerning the arrangement of this planetary system, the general facts of the periodicity of chemical properties gave us some provisional information. According to this, the electrons are

apparently arranged in individual shells. When one shell is completed, another is formed, corresponding to the beginning of a new period in the system of elements. The strengths (*Besetzungszahlen*) of the individual shell should coincide with the period numbers of the natural system (if we leave out of account a certain alteration in the sequence of the series).

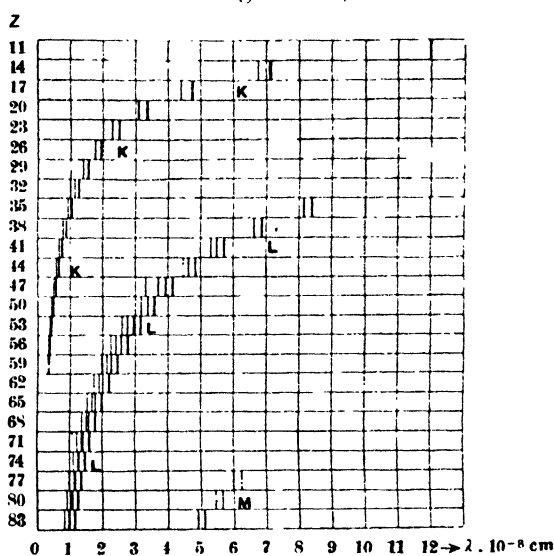

FIG. 46.

We shall call the shells in turn, counting from within outwards, the K-, L-, M-, N-, . . . *shell*. In the schematic picture of Fig. 47, we shall represent them by circles described about the nucleus as centre; in this sense, we often speak of a “K-, L-, . . . *ring*.”

We shall now describe (a) the phenomenon of excitation, (b) the process of emission for the K-, L-, M-radiation according to the plan of W. Kossel,* whose views seem to be more and more confirmed by the facts.

To excite K-radiation, an electron must be removed from the innermost shell, the K-ring, and transferred to the periphery of the atom. If the excitation occurs through the agency of cathode rays, it is easy to

* W. Kossel, Verh. d. Deutschen Physikal. Gesellsch., 1914, pp. 899 and 953; 1916, p. 339.

imagine that the tearing-off of the "K-electron" is effected by the impact of a cathode-ray particle that has penetrated into the atom. To detach the K-electron, a certain energy, lifting power, is necessary. The energy of the impinging cathode ray must be at least as great as this lifting energy. This sets a definite limit to the excitation necessary to produce the K-radiation, that is, there is a lower limit to the necessary hardness of the cathode rays. This agrees with the results of Barkla's researches as given above. If the excitation is effected not by cathode rays, but by primary Röntgen radiation, then we must demand for the corresponding minimum of its hardness, that its $h\nu$ (cf. Chap. I, § 6) is at least as great as the lifting power required to do the work of transference.

To excite the L-radiation, it is necessary to remove an electron from the L-shell to an outer position. The lifting work necessary is less than the corresponding work for the same atom in the case of a K-electron. Hence, for the L-electron, the hardness of the exciting cathode rays or Röntgen rays is less. To generate the M-radiation, whereby the attack is

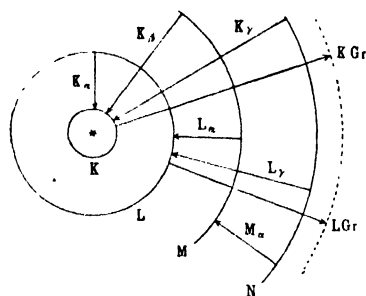

FIG. 47.

made on the M-shell, the necessary work of lifting and the hardness are correspondingly reduced. In Fig. 47 the process of excitation is represented diagrammatically by the arrows that point from within outwards. They bear the signs K-Gr. (K-Grenze = K-limit), L-Gr. (L-limit), and so forth.

Through the excitation the atom is prepared for the following process of emission. When the K-atom has been torn out, the K-shell strives to complete itself again. The missing electron may be furnished by either the L-shell or the M-shell, or some other. Whereas the process of excitation was accompanied by a gain of energy (work of lifting, absorption of energy), the converse process takes place with the loss of energy (energy of falling, emission). When, in our planetary system, an electron jumps into an orbit nearer the nucleus, the potential energy of the planetary system certainly becomes diminished. We shall show by a calculation later that the total energy (kinetic + potential) decreases. Hence energy is liberated. We assume that this appears in the form of energy of radiation, and that it is emitted as monochromatic radiation, that is, as radiation of one wave-length, in each case. According as, the missing electron, however, returns to the K-ring from the L-, M-, or N-ring, the energy set free will be different in amount: correspondingly there will be various possible K-radiations, each of which is represented by a definite wave-length. We talk of the K_α -line (transition from the L- to the K-shell), of the K_β -line (transition from the M- to the K-shell), of the K_γ -line (transition from the N- to the K-shell). The lines K_α , K_β , K_γ

complete itself again. The missing electron may be furnished by either the L-shell or the M-shell, or some other. Whereas the process of excitation was accompanied by a gain of energy (work of lifting, absorption of energy), the converse process takes place with the loss of energy (energy of falling, emission). When, in our planetary system, an electron jumps into an orbit nearer the nucleus, the potential energy of the planetary system certainly becomes diminished. We shall show by a calculation later that the total energy (kinetic + potential) decreases. Hence energy is liberated. We assume that this appears in the form of energy of radiation, and that it is emitted as monochromatic radiation, that is, as radiation of one wave-length, in each case. According as, the missing electron, however, returns to the K-ring from the L-, M-, or N-ring, the energy set free will be different in amount: correspondingly there will be various possible K-radiations, each of which is represented by a definite wave-length. We talk of the K_α -line (transition from the L- to the K-shell), of the K_β -line (transition from the M- to the K-shell), of the K_γ -line (transition from the N- to the K-shell). The lines K_α , K_β , K_γ

together constitute the *K-series*. $K\beta$ is *harder* than $K\alpha$, and $K\gamma$ is harder than $K\beta$ on account of the successive increase in the energy of falling that is available. On the other hand, $K\alpha$ is *more intense* than $K\beta$, and $K\beta$ is *more intense* than $K\gamma$ owing to the fact that the probability of the occurrence of the transition becomes successively smaller. It seems very plausible to suppose that the replacement of the missing electron is effected more often by the neighbouring shell than by the next or some later shell. In Fig. 47 these electronic transitions are represented by the arrows that point inwards to the nucleus; they are distinguished, in so far as they belong to the emission of K-lines, by the symbols $K\alpha$, $K\beta$, $K\gamma$.

Whereas all electronic jumps that end in the K-shell belong to the K-series, all these that end in the L-shell belong to the *lines of the L-series*. If a place in the L-shell has become vacant owing to a preceding excitation, the L-shell seeks to restore its full complement of electrons at the expense of the M- or the N-shell, and so forth. The energy that is hereby set free again appears as monochromatic radiation. We speak of the $L\alpha$ -line (transition from the M- to the L-shell), of the $L\gamma$ -line (jump from the N- to the L-shell), and so forth. $L\gamma$ must be harder than $L\alpha$, because the energy-difference between the N- and the L-shell is greater than that between the M- and the L-shell. On the other hand $L\alpha$ will be more intense than $L\gamma$, because the transition from the neighbouring M-shell seems more probable than from the more distant N-shell. In Fig. 47, the inwardly directed arrows $L\alpha$ and $L\gamma$ end in the L-shell. Concerning the naming of these arrows it must be remarked that there are also *lines* $L\beta$ and $L\delta$ which, however, like a series of further lines of the L-series, have not yet been successfully fitted into our provisional scheme. The following sections will deal further with this circumstance.

Finally, electronic transitions that end in the M-shell, furnish differences of energy that correspond to emissions of lines of the M-series. In our figure this series is represented by only one line, $M\alpha$, corresponding to the transition from the N- into the M-shell. Actually, it, too, consists of several lines.

In several absorption experiments with light substances (water, aluminium, paper) Barkla believed in 1917 that he had detected signs of a radiation still harder than K-radiation; he called it J-radiation. Repeated tests by other observers have, however, not been able to confirm the existence of this radiation.* Nor has the theory a place for such radiation, so that we must regard K-radiation as the hardest possible radiation; this is expressed in our figure.

In succession to Fig. 47 we give Fig. 48 as a still more schematic illustration of the process of emission of Röntgen rays. This diagram has an advantage in that it takes more account of the quantitative aspect of the phenomenon. In it we visualise the various shells not by their

* Cf. the summarised remarks of Ritchmeyer, Phys. Rev., 17, 433 (1921).

relative positions in the atom but by their relative energy-differences. Thus we draw a succession of *energy-steps* such that the difference of height between two steps gives the energy that is liberated when an electron drops from the higher to the lower step (orbit). The lowest step bears the sign K, the next L, and so forth. The energy-level of the nucleus is to be considered at $-\infty$. The highest dotted limit of the steps corresponds to the periphery of the atom. The quantitative drawing of the picture leads us to assign to the successive steps K, L, M, N, . . . the series of integral "quantum numbers" 1, 2, 3, 4, . . . in such a way that the position of each step below the highest level is, at least to a certain degree of approximation, proportional to

$$\frac{1}{1^2}, \frac{1}{2^2}, \frac{1}{3^2}, \frac{1}{4^2}, \dots$$

Accordingly we make the height of the steps in the figure decrease, from

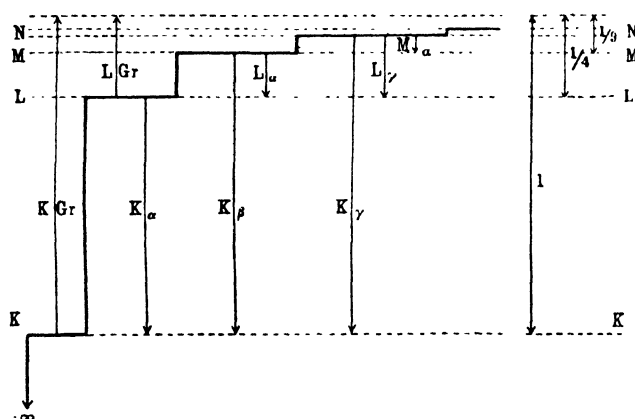

FIG. 48.

the bottom upwards, in the manner indicated by the differences of height 1, $\frac{1}{4}$, $\frac{1}{9}$, . . . written at the side (on the right). Moreover, we again draw the arrows K_α, K_β, . . . , L_α . . . that correspond to the various possibilities of energy-emission, and the arrows K-Gr, L-Gr, which correspond to the various kinds of energy-absorption.

This theoretical diagram enables us to understand at once the general laws for the hardness of Röntgen lines that came into evidence in Fig. 46. We must thereby bear in mind the fundamental quantum principle that we deduced in Chapter I, § 6, eqn. 6 from the photo-electric effect, namely: *the greater the available difference of energy, the greater the hardness of the consequent Röntgen radiation (and therefore, the smaller its wave-length).*

Or, in symbols,

$$h\nu = W_a - W_e \dots \dots \dots (1)$$

Here h is Planck's quantum of action (see p. 37); ν is the oscillation frequency of the emitted Röntgen line under consideration (inversely pro-

portional to its wave-length). The right side of the equation denotes the energy-difference of the atom between its initial and its final configuration, and is, therefore, represented quantitatively in Fig. 48 by the length of the arrow that represents the Röntgen lines in question. That is, *the arrows in our figure show by their length the hardness of the corresponding Röntgen radiation*. According to equation (5) of Chapter I, § 6, the same holds for the arrows of the excitation limits that signify the absorption of corpuscular energy or wave-energy. In this case, we need merely reverse the sign of the right side of equation (1), for this corresponds to reversing the direction of the arrow in the figure.

Hence it follows: *for one and the same atom the K-series is harder than the L-series which, in turn, is harder than the M-series*. Within the K-series the hardness increases from $K\alpha$ beyond $K\beta$ to $K\gamma$, but in ever decreasing steps, and finally arrives approximately at the hardness of the K-limit. The same holds for the L-series, and the same for the others. But further, the available differences of energy depend essentially on the amount of the nuclear charge. The greater the nuclear charge (and hence the atomic number of the element), the more intense is the electric field around the nucleus. The energy-steps become greater as the Z increases (as a rough approximation, they increase proportionately to Z^2 , as we shall see later). But this means that *the hardness of each series or line increases for each step forward in the natural system of elements*. A glance at Fig. 46 shows how perfectly these theoretical deductions agree with the facts of observation.

§ 5. The K-series. Its Bearing on the Periodic System of Elements

Following in the footsteps of Barkla, Moseley* was the first to bring the emission of the Röntgen lines into relationship with the scheme of the natural system.

His first photographs (1913) dealt with the K-series of the elements between Ca, $Z = 20$, and Cu, $Z = 29$, inclusive. The elements were successively fixed into the X-ray bulb as anti-cathodes. Thus the characteristic rays were excited directly by means of cathode rays; this has the advantage that the excited rays are more intense than when produced by the method of secondary rays (excitation by primary X-rays). Moseley further increased the intensity by fixing the slit that limited the X-ray pencil very close to radiating cathode in the X-ray bulb. In this way he simultaneously obtained a wide angular aperture for the emergent pencil and also the possibility of establishing the region of wave-lengths of the K-series by means of the position of the crystal which was fixed for each element, but had to be appropriately altered in passing from one element to the next.

Thus Moseley did not use the method of the revolving crystal (cf. § 3).

* H. G. J. Moseley, *The High Frequency Spectra of the Elements*, Phil. Mag., 26, 1024 (1913); 27, 703 (1914).

Referring to Fig. 41, which depicts the latter method, we may describe his arrangement as follows. In place of the slits S_1, S_2 a slit S is fixed very close to the anti-cathode A . The crystal stands on the spectrometer table T , which may be rotated, but which is kept fixed for each photograph. The position of the crystal towards the very divergent incident pencil is chosen so that reflection angles that are necessary for the wave-lengths to be photographed lie within the limits of the incident angles. The photographic plate is set up in accordance with the focal condition discussed in § 2, that is, at the same distance from the crystal as that between the crystal and the slit S , and, further, the plate is turned correspondingly when the crystal is turned as we pass from element to element.

Let us next look at a now famous figure in Moseley's paper. The photographs have here been pasted above each other successively so that

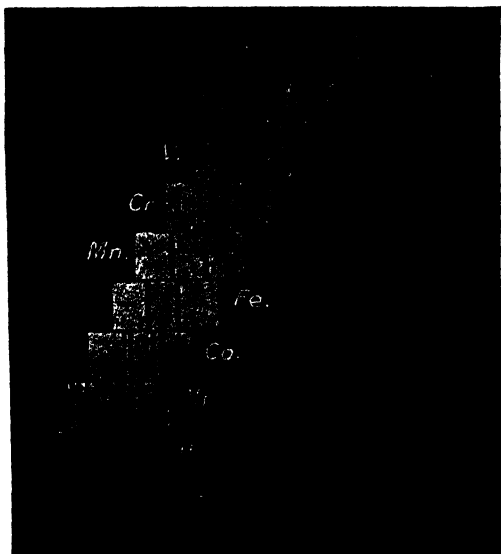

FIG. 49.

positions vertically below one another denote equal wave-lengths. The wave-lengths increase as we pass from the left to the right. We learn from Fig. 49:—

1. As the atomic number increases, corresponding lines in the spectra move regularly and successively towards the region of smaller wave-lengths. **The hardness of the lines increases as Z increases.** We are familiar with this fact through Barkla's investigations (cf. the preceding paragraph), in which it assumed a less definite form.

This law is true not only

of the K -series but also of the L - and M -series, as we learn from Fig. 46.

2. In the case of each element, two lines occur: they are *the more intense but softer line $K\alpha$ and the less intense but harder line $K\beta$* , which we have already met under the same names in the preceding paragraph. The faint line $K\gamma$ that was also mentioned earlier is not distinguishable from the $K\beta$, and appears only when refined spectroscopic methods are applied.

3. The X-ray spectra are a pure property of the atom, and, indeed, an *additive property*. The last picture of the series, which represents brass, that is, an alloy of Cu and Zn , accordingly exhibits the same lines as the preceding element Cu and the following element Zn (not shown in our figure). Further, we observe in the case of Co , which it is difficult

to separate from Ni and Fe (first triad of the periodic system), besides the α - and β -line of Co also less intense images of the α -lines of Fe and Ni.

4. The order of Co and Ni in the periodic system is rectified by this result of X-ray analysis. Whereas, according to the values of the atomic weights, Ni should precede Co (at. wghts. being 58.68 and 58.97 respectively), we had to write Co before Ni in the chemical scheme of Table 2, page 57. The X-rays are not deceived by the atomic weight and so they confirm the true order CoNi. *Not the atomic weight, but the atomic number governs the Röntgen spectra.*

The atomic number introduces order into the natural system, whereas the atomic weight introduces disorder.

The same is true of the order of Te and J and this is likewise established properly by Röntgen analysis (cf. Fig. 51). The third space of the natural system with the unnatural order of the elements (according to atomic weight) was A, K ($Z = 18$ and 19). The Röntgen spectrum of argon is, indeed, still wanting, but there can be no doubt that it, too, will decide against the atomic weight and in favour of the atomic number.

As Rutherford incidentally remarks, the original problem that Moseley was trying to solve when he set about his experiment was to determine whether it was not the nuclear charge, instead of the atomic weight, that decided the nature and the hardness of the characteristic Röntgen radiation.

5. Since the discovery of the periodic system, particular interest was centred on the presence of gaps and the prediction of new elements in the system (cf. p. 72). In Moseley's figure, the rare element scandium is missing between Ca and Ti. Its absence is betrayed by a great leap between the elements Ca and Ti that succeed one another in the figure.

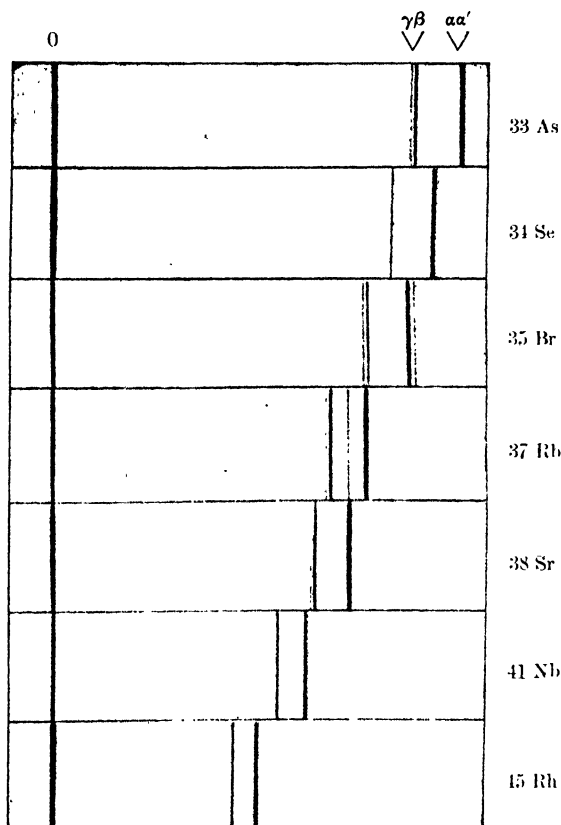

FIG. 50.

The regular increase (that was emphasised in 1) in the hardness as Z increases reveals infallibly every gap in the system. Whereas, in the case quoted, we were dealing with the known element Sc, we shall see in Figs. 50 and 51 a similar gap at $Z = 43$ (eka-manganese) that points to an element not yet discovered. Also the remaining gaps in the system ($Z = 61, 75, 85, 87$, cf. Table 2) have been confirmed by the method of Röntgen rays. In this way the Röntgen spectra have led to the definite conclusion that the *number of gaps must be five*.

Partly to continue Moseley's figure in the direction of increasing atomic numbers and partly to bring into evidence the advances that have been made in photographing Röntgen rays, we give as our next illustration Fig. 50, by Siegbahn: it represents the elements from As, $Z = 33$, to Rh, $Z = 45$. In this case the spectra have been taken by the method of the revolving crystal; as a result, the lines are sharper than in Moseley's case and more completely separated. Besides the second most intense line $K\beta$, we see here also the *faint line* $K\gamma$ (to the left, and hence harder than $K\beta$), the origin of which we know from the preceding section. Further, we see that the most intense line $K\alpha$ of the doublet (α, α') has been resolved (α' is to the right of α , and hence is softer). Besides these lines, the zero mark (on the extreme left) has been photographed; it is made by the undiffracted primary radiation.

The same remarks apply to this figure as to the former; the hardness increases for each line as the atomic number increases; the Sr-line adulterates to the Rb-spectrum; gaps occur in the succession of the elements, exhibited by irregularly great differences in the hardness, namely, between Br, $Z = 35$, and Rb, $Z = 37$, the inert gas Kr, $Z = 36$, is missing. As in the case of A above, it is difficult to get an X-ray spectrum of Kr. Between Sr, $Z = 39$, and Nb, $Z = 41$, there are missing Y and Zr, $Z = 39$ and 40 respectively. Finally, between Nb and Rh three elements, namely, Mo, Ru, and the unknown element eka-manganese, are missing.

Before giving the complete list of the wave-lengths of the principal lines of the K-series as far as they have been measured, we give in Table 9 a little list of the notation of the various lines, and, partly to revive our earlier remarks, of the origin and intensity of the lines.

TABLE 9

Our notation.	Siegbahn.	Origin.	Intensities.
α'	α_2	$L_{22} \rightarrow K$	8
α	α_1	$L_{21} \rightarrow K$	10
β	β_1	$M \rightarrow K$	4
γ	β_2	$N \rightarrow K$	1

The lines are arranged in order of increasing hardness. In Siegbahn's notation two groups of lines are distinguished, the soft α -lines and the

harder β -lines; he numbers the lines in both groups according to their intensity. A number of fainter lines that occur only in the case of the lowest atomic numbers, and that are to bear the names $a_3, a_4, a_5, a_6, \beta_3, \beta'$ according to Siegbahn, are not included in our list. All data about intensity are fairly rough estimates and merely denote relative numbers.

The data concerning the origin of the lines agree with the account given in the preceding section. All transitions end in the K-shell; to produce $K\alpha$, the electron jumps from the L-shell, to produce $K\beta$ it jumps from the M-shell, and to produce $K\gamma$ from the N-shell. But now, to supplement the preceding section, we must *subdivide the L-shell into two parts*, which we call the L_1 - and the L_2 -shell. In the picture of Fig. 48 the L_2 -shell would lie below the L_1 -shell (there called L-shell); in the picture of Fig. 47, the L_2 -ring would lie within the L_1 -ring (which is there the L-ring).

In Table 9 the lines a', a are bracketed together to indicate that they form a related doublet (which is not the case with the $\beta\gamma$ lines). The exact definition of what we call "**doublet**" cannot be developed except in conjunction with the facts discussed in the next section. A necessary if not a sufficient condition for a doublet, is that either the initial level or the final level (as in the case of $K\alpha$ and $K\alpha'$) of the transition must coincide for the lines of the doublet.

Turning next to Table 10 we must first say a word or two about the choice of the wave-lengths. In optical regions we measure wave-lengths in **Ångström units** (Å), which are such that

$$1 \text{ Å} = 10^{-8} \text{ cms.} = \frac{1}{10} \mu\mu.$$

In the case of Röntgen rays, too, the older measurements were usually expressed in terms of Ångström units. But when Siegbahn,* in 1919, by means of an elaborate refinement of the apparatus and of the means of taking readings (from a double photograph of the same line for two different but exactly determinable positions of the crystal), succeeded in increasing the accuracy of measurement a hundred-fold, it was found to be expedient to introduce a more convenient unit of smaller value. The new unit proposed by Siegbahn is

$$1 \text{ X} = 10^{-11} \text{ cms.}$$

The wave-lengths of X-rays are then described in **X-units** just as the wave-lengths in the visible are described in Ångström units: for example, according to our table, for the

$$K\alpha \text{ of Ca: } \lambda = 3351.86 \text{ X-units,}$$

and as a parallel to this we have in the visible spectrum the Fraunhofer line

$$K \text{ of Ca: } \lambda = 3933.83 \text{ Å-units.}$$

* Röntgenspektroskopische Präzisionsmessungen, Ann. d. Phys., 59, 56 (1919).

In our table the more recent precision measurements appear to two decimal places, the older measurements only in whole X-units. The abbreviations which follow the numbers signify the observers; the key to these letters is:—

- M. = J. Malmer, Dissertation, Lund, 1915.
 S. Fr. = M. Siegbahn and E. Friman, *Ann. d. Phys.*, **49**, 611 (1916).
 S. St. = M. Siegbahn and W. Stenström, *Physikal. Zeitschr.*, **17**, 48, and 318 (1916).
 U. C. = H. S. Uhler and E. D. Cooksey, *Phys. Rev.*, **10**, 645 (1917).
 D. Hu = W. Duane and Kang-Fuh-Hu, *ibid.*, **11**, 489 (1918), and **14**, 369 (1919).
 S. = M. Siegbahn, *Ann. d. Phys.*, **59**, 56 (1919).
 H. = E. Hjalmar, *Zeitschr. f. Phys.*, **1**, 439 (1920).
 St. = N. StenSSon, *ibid.*, **3**, 60 (1920).
 D. St. = W. Duane and W. Stenström, *Proc. Nat. Acad.*, **6**, 477 (1920).

The measurements first deal with the angle of incidence θ . From them we calculate the wave-lengths according to the method given at the end of § 3. At the top of the table the lines a , a' have not yet been separated. The fact that, of the metals of atomic number greater than 60, it is just tungsten that is quoted, is due to the use of tungsten as the anti-cathode in the Coolidge tube. Whereas the other gaps are obviously merely accidental (for example, the inert gases are as yet all missing), the γ -line seems to reach its limit in the neighbourhood of Ca, $Z = 20$, and is absent in the case of lighter elements. The reason is clearly to be discerned in the incomplete development of the outer electronic shells as the atomic number becomes smaller. Whether and where the β -line reaches a corresponding limit is not yet decided.

In our table the values of λ vary from 12 Å to 0.2 Å. At the limits (both of the hard and of the soft rays), technical difficulties arise in photographing the lines, which at present prevent a further extension of the series of observations.

The difficulty due to the strong absorption of very soft rays is overcome by constructing a vacuum spectograph (cf. p. 135). But the difficulty offered by the lattice constant remains. The fundamental equation (3) of page 129.

$$\sin \theta = \frac{n\lambda}{2d} \quad . \quad . \quad . \quad . \quad . \quad (1)$$

requires also for $n = 1$ (observation in the first order of reflection, to which we may restrict ourselves in dealing with very soft rays) that

$$2d > \lambda \quad . \quad . \quad . \quad . \quad . \quad (2)$$

The lattice constant for the cube surface of rock-salt was, as we calculated at the end of § 3, $d = 2.814 \cdot 10^{-8}$ cms. According to this rock-salt may be used only as far as wave-lengths not exceeding $\lambda = 5$ Å. Fortunately gypsum and mica are available as two good crystals that have a considerably greater lattice constant. (This is in conformity with

TABLE 10

Wave-lengths of the K-series

Z	α'	α	β		γ	
11 Sodium	11883.6	H.	11591	H	—	
12 Magnesium	9867.75	"	9534.50	"	—	
13 Aluminium	8319.40	"	7940.50	"	—	
14 Silicon	7109.17	"	6739.33	"	—	
15 Phosphorus	6141.71	"	5785.13	"	—	
16 Sulphur	5360.66	"	5019.13	"	—	
17 Chlorine	4721.85	Ste.	4718.70	S.	—	
19 Potassium	3737.25	"	3733.86	"	—	
20 Calcium	3355.12	"	3351.86	"	3067.40	H.
21 Scandium	3028.63	"	3025.26	"	2755.5	"
22 Titanium	2746	S. St.	2742	S. St.	2493.67	"
23 Vanadium	2502	"	2498	"	2265.37	"
24 Chromium	2289.28	Ste.	2285.17	S.	2071	[S. St.]
25 Manganese	2097	S. St.	2093	S. St.	1902	S. St.
26 Iron	1936.60	Ste.	1932.39	S.	1753.97	S.
27 Cobalt	1789.52	"	1785.24	"	1617.15	H.
28 Nickel	1658.60	"	1654.67	"	1496.69	"
29 Copper	1541.22	"	1537.36	"	1388.87	"
30 Zinc	1437	S. St.	1433	S. St.	1294	S. St.
31 Gallium	1341.61	U. C.	1337.85	U. C.	1205.91	U. C.
32 Germanium	1261	S. St.	1257	S. St.	1131	S. St.
33 Arsenic	1174	S. Fr.	1170	S. Fr.	1052	S. Fr.
34 Selenium	1109	"	1104	"	993	"
35 Bromine	1040	"	1035	"	929	"
37 Rubidium	926	"	922	"	825	"
38 Strontium	876	"	871	"	779	"
39 Yttrium	840	M.	835	M.	746	M.
40 Zirconium	793	"	788	"	705	"
41 Niobium	754	S. Fr.	749	S. Fr.	669	S. Fr.
42 Molybdenum	712.12	D. Hu.	707.83	D. Hu.	631.10	D. Hu.
44 Ruthenium	—	"	645	M.	574	M.
45 Rhodium	616.4	"	612.1	D. Hu.	545.3	D. Hu.
46 Palladium	590	M.	586	M.	521	M.
47 Silver	567	"	562	"	501	"
48 Cadmium	543	"	538	"	479	"
49 Indium	515	"	510	"	453	"
50 Tin	490	"	487	"	432	"
51 Antimony	472	"	468	"	416	"
52 Tellurium	—	"	456	"	404	"
53 Iodine	—	"	437	"	388	"
55 Caesium	402	"	398	"	352	"
56 Barium	393	"	388	"	343	"
57 Lanthanum	376	"	372	"	329	"
58 Cerium	360	"	355	"	314	"
59 Praseodymium	347	"	342	"	301	"
60 Neodymium	335	"	330	"	292	"
74 Tungsten	213.41	D. St.	208.60	D. St.	184.20	D. St.

the immediately obvious rule that, usually, net planes of crystals that cleave very readily have a large lattice constant.) The lattice constant of gypsum is $d = 7.621 \cdot 10^{-8}$ cms. (according to a remark at the end of § 3, it may be obtained from the lattice constant d of rock-salt by photographing one and the same line with the two crystals in turn). By

condition (2) then, gypsum suffices as far as wave-lengths not exceeding $\lambda = 15 \text{ \AA}$. As a matter of fact, the soft lines of Table 14 were obtained by means of an analyser of gypsum. If, later, we should wish to pass on to still greater wave-lengths, the crystal of gypsum would also have too small meshes. We should then have to resort to organic crystals of complex molecular structure.

On the other hand, the difficulties offered by very hard rays are that the angle θ in (1) becomes too small, thus depreciating the accuracy very much. When λ/d is very small, we are dealing with a glancing angle of incidence and of reflection between the Röntgen rays and the crystal plate. We may escape this, on the one hand, by making observations in a higher order (cf the factor n in eqn. (1)), on the other hand, by using net planes whose distance apart, d , is as small as possible. Changing the crystal does not help us much in the latter respect. Whereas we had in the case of rock-salt $a = 2d = 5.63 \cdot 10^{-8}$, we have in the case of the crystal of smallest known lattice constant, namely, diamond, $a = 3.55 \cdot 10^{-8}$. Greater advantage is obtained by passing from one crystal surface (for example, from the cube surface 100) to another with higher indices (for example, the octahedral surface 111), whereby d becomes smaller (e.g. in the ratio $\sqrt{3}$, cf. eqn. (4) in § 3). But both these advantages, gained by using a higher order of reflection and surfaces with higher indices, are obtained at the expense of intensity.

From the wave-lengths λ we pass on to the **wave-numbers** $\frac{1}{\lambda}$ (*number of wave-lengths that occur in 1 cm. of a light-ray*). Following the usual practice of spectroscopy, we use (in a strict sense, wrongly) the same letter as for the **vibration number** or **frequency** (number of full vibrations that occur per sec.). We thus have the two meanings for ν , which differ in their dimensions :

$$\nu = \frac{1}{\lambda} = \text{wave-numbers (cm.}^{-1}\text{)} \quad . \quad . \quad . \quad (3)$$

$$\nu = \frac{1}{\tau} = \frac{c}{\lambda} = \text{frequency (sec.}^{-1}\text{)} \quad . \quad . \quad . \quad (4)$$

It is the latter meaning that we always have in mind when we speak of the energy-quantum $h\nu$; we are referring to the former when we write down spectral formulæ. For the rest, we shall not always keep strictly to the term wave-number, but shall occasionally replace it by the more usual term "*frequency*" in spectroscopy.

Furthermore, we introduce a universal wave-number which will serve as the unit of measure for all remaining wave-numbers, namely, the **Rydberg-Ritz constant**. We give it this name because it first played a fundamental part in the series formulæ of Rydberg, and later in those of Ritz (cf. Chap. VI, § 1). We assign to it the symbol R (instead of the spectroscopically more usual letter N, which we used in the preceding

editions of this book); its numerical value, according to Paschen (cf. Chap. IV, § 4), is

$$R = 109737 \text{ cm.}^{-1} \quad (5)$$

The term **Rydberg frequency** which we shall often have occasion to use is just as little correct as the term "vibration number" for $\frac{1}{\lambda}$, since it corresponds, not to the dimensions cm.^{-1} , but to sec.^{-1} . To retain the strict sense of the word we should have to apply the term Rydberg frequency to the quantity :

$$cR = 3.00 \cdot 10^{10} \cdot 109737 = 3.29 \cdot 10^{15} \text{ sec.}^{-1} \quad (6)$$

For the ratio $\frac{\nu}{R}$, however, which will alone concern us later, the difference (3, 4) and (5, 6) is of no account. By forming this ratio we arrive at an un-named number independent of the units of measure, which, moreover, is of a convenient order of magnitude for all X-ray measurements. Thus Table 11 represents in the first four columns the values of $\frac{\nu}{R}$ for the principal lines of the K-series. Next to these, in the last two

columns, are the values of $\sqrt{\frac{\nu}{R}}$ for the two lines $K\alpha$ and $K\beta$ (at the head of the columns these numbers are briefly called \sqrt{a} and $\sqrt{\beta}$ respectively).

We first direct our attention to these last two columns. They form an arithmetic series, that is, there is a constant increase in passing from element to element. This increase is particularly regular at the beginning of the table; later, it increases a little. We read this off from Fig. 51, in which, following Siegbahn, we plot the values of $\sqrt{\frac{\nu}{R}}$ as a function of the atomic numbers. The α - and β -lines (the two middle lines of the figure) ascend regularly and, except for a small curvature for larger Z 's, they are straight lines. The neighbouring lines α' and γ (the two extreme lines) follow the same course.

In this figure our earlier statements about the behaviour of X-ray spectra and their relation to the natural system of elements are made particularly clear. We see the uniform (in our picture, linear) increase of the hardness with the atomic number and conclude from it that the hardness is determined by the nuclear charge of the element. This strengthens our belief that the Röntgen spectra arise through changes of configuration that occur near the nucleus, in the innermost region of the atom (cf. Chap. II, § 7). There is not a trace of the periodicity of the elements here. We interpreted this earlier as signifying that only the peripheral parts of the atom are periodic in structure, but that energetic conditions in the interior of the atom alter uniformly with the nuclear charge.

Gaps in the system of the elements are exposed with particular

TABLE 11

 ν/R values of the K-series

Z	α'	α	β	γ	$\sqrt{\alpha}$	$\sqrt{\beta}$
11 Na	76.688		78.62	—	8.757	8.867
12 Mg	92.848		95.576	—	9.610	9.776
13 Al	109.535		114.762	—	10.466	10.713
14 Si	128.182		135.217	—	11.322	11.628
15 P	148.374		157.519	—	12.181	12.556
16 S	169.992		181.559	—	13.038	13.474
17 Cl	192.99	193.12	207.366	—	13.897	14.400
19 K	243.83	244.06	264.413	—	15.622	16.261
20 Ca	271.61	271.87	295.581	297.082	16.488	17.190
21 Sc	300.88	301.22	328.544	330.7	17.356	18.126
22 Ti	331.9	332.3	363.238	365.433	18.23	19.059
23 V	364.2	364.8	399.735	402.260	19.10	19.993
24 Cr	398.06	398.78	437.81	440.0	19.969	20.924
25 Mn	434.6	435.4	479.1	481.6	20.87	21.89
26 Fe	470.55	471.58	519.55	523.1	21.716	22.794
27 Co	509.23	510.45	563.503	567.4	22.593	23.738
28 Ni	549.42	550.73	608.856	612.4	23.468	24.675
29 Cu	591.26	592.75	656.122	661.8	24.347	25.615
30 Zn	634.1	635.9	704.2	711.4	25.22	26.53
31 Ga	679.23	681.14	755.67	—	26.099	27.190
32 Ge	722.7	725.0	805.7	812.9	26.93	28.39
33 As	776.2	778.9	866.2	877.9	27.91	29.43
34 Se	821.7	825.4	917.6	—	28.73	30.29
35 Br	876.2	880.5	980.9	997.0	29.67	31.32
37 Rb	984.1	988.4	1105	1121	31.14	33.24
38 Sr	1040	1046	1170	1188	32.34	34.21
39 Y	1085	1091	1222	1243	33.03	34.96
40 Zr	1149	1156	1293	—	34.00	35.96
41 Nb	1209	1216	1362	1387	34.87	36.91
42 Mo	1279.6 ₆	1287.4 ₁	1443.9 ₁	1470.5	35.772	38.00
44 Ru	—	1413	1588	—	37.59	39.85
45 Rh	1478.5	1488.8	1671.1	1705.9	38.585	40.88
46 Pd	1515	1555	1749	—	39.43	41.82
47 Ag	1607	1621	1819	1856	40.26	42.65
48 Cd	1678	1694	1902	—	41.16	43.62
49 In	1769	1787	2012	2071	42.27	44.86
50 Sn	1860	1871	2109	—	43.26	45.93
51 Sb	1931	1947	2191	2234	44.13	46.81
52 Te	—	1998	2256	—	44.70	47.49
53 J	—	2085	2349	—	45.66	48.48
55 Cs	2267	2289	2589	—	47.85	50.87
56 Ba	2319	2348	2657	—	48.46	51.55
57 La	2424	2450	2770	—	49.50	52.64
58 Ce	2531	2567	2902	—	50.67	53.88
59 Pr	2626	2665	3027	—	51.63	55.03
60 Nd	2720	2761	3127	—	52.56	55.92
74 W	4270.0	4368.5	4947.2	5090.6	66.095	70.336

clearness and certainty by this mode of representation. If the figure had been drawn without taking into account the gap at $Z = 43$ (ekamanganese), a discontinuity would have come to light in the diagram of the line, and would immediately have betrayed the missing element. Notice, also, the order of Te ($Z = 52$) and J ($Z = 53$), which cannot be doubted

in our figure and which satisfies the requirements of chemical theory (since J thereby comes below F, Cl, Br, in the seventh vertical line).

But it is also interesting to consider the amount of the increase in $\sqrt{\nu/R}$ in Table 11, particularly in the case of $K\alpha$. It is about

$$0.866 = \sqrt{\frac{3}{4}}$$

Consequently we may express the linear increase in Fig. 51, for the present, by the following formula:—

$$\sqrt{\frac{\nu}{R}} = \sqrt{\frac{3}{4}}(Z - s).$$

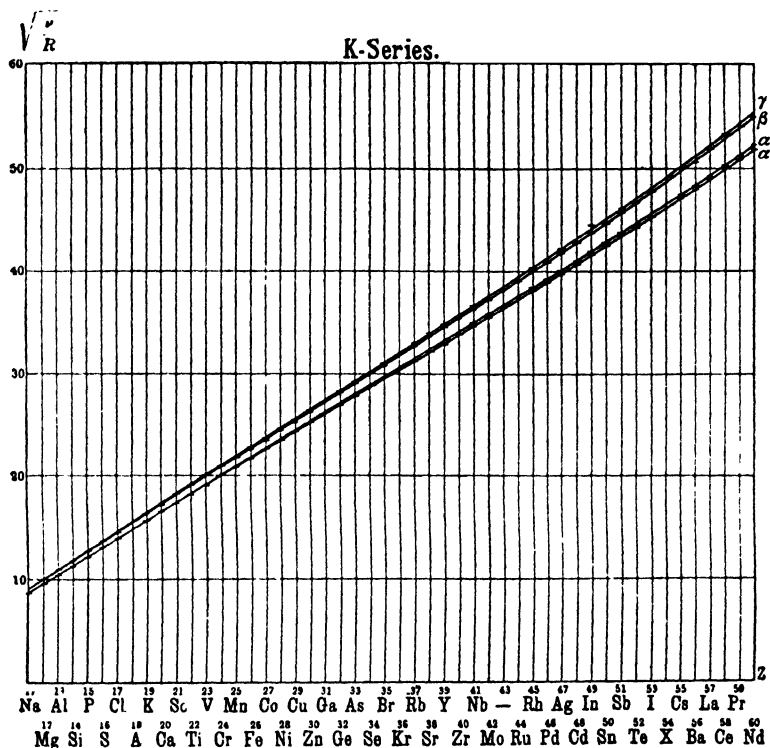

FIG. 51.

It further follows from the figure that the constant s here introduced is almost equal to 1. We thus arrive at the following representation of the wave-number, developed earlier by Moseley:—

$$\frac{\nu}{R} = \frac{3}{4}(Z - 1)^2 = (Z - 1)^2 \left(1 - \frac{1}{4}\right) = (Z - 1)^2 \left(\frac{1}{1^2} - \frac{1}{2^2}\right) \quad (7)$$

This formula shows a close analogy to Balmer's expression for the Hydrogen series (cf. Chap. IV, § 2) and may be interpreted in the sense

of eqn. (1), page 146, of the preceding section as follows. The transition electron comes from the initial energy-level of the L-Shell

$$W_a = - R h^2 \frac{(Z - 1)^2}{2^2} \dots \dots \dots (8)$$

and falls to the energy-level of the K-shell

$$W_c = - R h^2 \frac{(Z - 1)^2}{1^2} \dots \dots \dots (9)$$

No importance is attached to the use of the negative signs before the energy amounts; they occur because, in Fig. 48, we calculated the energy-steps from the surface of the atom and called the energy-step of the nucleus $-\infty$. By adding a sufficiently great constant that would cancel out in the energy *differences*, we could make both amounts of energy (8) and (9) positive. By forming, in accordance with eqn. (1) of the preceding paragraph, the quantity $h\nu = W_a - W_c$, we get, if we cancel the common factor h , the value of r from eqn. (7) just above.

According to the most recent view of the theory, we may no longer regard Moseley's equation (7) as exact. A complete description of the $K\alpha$ -line for all atomic numbers Z should also be able to account for the slight curvature of the plotted line in Fig. 51: nor could it rest satisfied with the above approximate determination of the constant $s = 1$. The theory attains this, on the one hand, by applying a **relativity correction** to Moseley's formula (cf. the last chapter), on the other, by penetrating further into the nature of the atomic model and to find a reason for the finer constitution of the K- and L-level. Nevertheless it will never fail to excite wonder that Moseley, in his first entrance into the realm of quantitative X-ray spectroscopy, also made the first and most important step in giving the theoretical interpretation of high-frequency spectra.

§ 6. The L-series and the M-series. Doublet Relationship

The simplicity of the spectral laws that distinguishes the Röntgen from the visible region is founded, according to the opening words of § 4, in the circumstance that in the interior of the atom, under the influence of the true nuclear charge, the electrons are arranged according to simple laws, whereas towards the periphery of the atom, at which the visible spectra originate, the arrangement of the electrons becomes gradually more complex and more difficult to grasp. For this reason, too, we find even the L-series to be of more complex structure than the K-series.

This increase of complexity in the L-series manifests itself largely in the fact that its lines occur in greater number. Table 12 on page 159 gives a survey of the various names, the supposed origin, and the approximate intensities of the main lines; besides the lines there included there are various other weaker lines that have been observed only in the case of a

few elements. We shall return to the latter lines in the last chapter. We have already given a picture of the L-series of platinum in Fig. 43, § 3.

Our nomenclature agrees with Moseley's, as far as his goes (Moseley measured and named only the lines β , γ , δ , ϕ), and seeks to extend it systematically by using the later letters in the order in which they occur at the beginning and end of the Greek alphabet. On the other hand Siegbahn's nomenclature recognises three group of lines that may be distinguished roughly by their varying hardness, namely: a rather soft α -group, a medium β -group, and a rather hard γ -group, whereby, however, the degree of hardness or softness of course changes with the atomic number as we pass along the elements in succession. Siegbahn numbers the lines within each group according to their intensity. The intensities are given as relative terms; their values fluctuate a little for each element, and must, therefore, be regarded merely as estimated averages.

TABLE 12

Sommerfeld	Siegbahn	Origin	Intensities
$\left. \begin{matrix} \alpha' \\ \alpha \\ \beta \end{matrix} \right\}$	a_2 a_1 β_1	$M_2 \rightarrow L_{-1}$ $M_1 \rightarrow L_1$ $M_2 \rightarrow L_{-2}$	3 10 8
$\left. \begin{matrix} \gamma' \\ \gamma \end{matrix} \right\}$	β_2	$N_4 \rightarrow L_{-1}$ $N_3 \rightarrow L_1$	0 6
$\left. \begin{matrix} \delta \\ \epsilon \end{matrix} \right\}$	γ_1 l	$N_4 \rightarrow L_{-2}$ $M_5 \rightarrow L_{-1}$	4 3
$\left. \begin{matrix} \eta \\ \zeta \end{matrix} \right\}$	η β_3	$M_5 \rightarrow L_{-2}$ $O \rightarrow L_1$	0 1
$\left. \begin{matrix} \theta \\ \iota \end{matrix} \right\}$	γ_2, γ_6 β_6	$O \rightarrow L_{-2}$ $N_7 \rightarrow L_{-1}$	1 0
$\left. \begin{matrix} \phi' \\ \phi \end{matrix} \right\}$	γ_5 β_4	$N_7 \rightarrow L_{-2}$ $M_4 \rightarrow L_{-3}$	0 2
$\left. \begin{matrix} \chi' \\ \chi \end{matrix} \right\}$	β_3	$M_3 \rightarrow L_{-3}$	3
$\left. \begin{matrix} \chi' \\ \chi \end{matrix} \right\}$	γ_2, γ_7 γ_3	$N_6 \rightarrow L_{-3}$ $N_5 \rightarrow L_{-3}$	1 1
ψ	γ_4	$O \rightarrow L_3$	1

The order followed in our Table 12 does not entirely agree with the order of the hardness of the lines. We always have, indeed, α softer than β , and γ softer than δ , but β is not in the case of all elements softer than γ . The softest line in the case of all elements is ϵ (discovered by Siegbahn, and called by him l). Manifold overlapping occurs among the lines β , γ , and ϕ . Further details may be found by the reader in Figs. 53 and 54. The latter figure also shows the complex conditions that obtain between the lines χ , χ' and θ . In the case of the lowest atomic numbers, θ is softer than χ and χ' , but in highest atomic numbers it is harder. In the case of Pt and Au, θ coincides with χ' ; in that of Pb and Bi, it coincides with χ . In the preceding editions of this book we followed Friman by identifying θ with χ' ; this, in the case of W, would apparently lead to a contradiction to Stokes' Fluorescence Law (cf. Note 1, p. 184).

Concerning the origin of the lines the following suggestions are contained in Table 12. As already indicated in Figs. 47 and 48, the line $L\alpha$ corresponds to the transition of an electron from the M- into the L-shell, the line $L\gamma$ to the transition from the N- into the L-shell. It now becomes necessary, however, to subdivide these shells further. Even in Table 9 of the preceding section, we distinguish two L-shells, L_1 and L_2 ; it now becomes necessary to assume a third energy-level L_3 . In the case of the M-shell, we have to distinguish five such steps, M_1, M_2, M_3, M_4, M_5 . The N-shell is also to be subdivided, and indeed, still more than the M-shell. The deeper theoretical reason for this at present apparently arbitrary differentiation can be given only when we get to the last chapter.

As is indicated by the brackets in the first column of Table 12 (on the right of the symbols for the lines), the line-pairs $(\alpha'\beta), (\gamma'\delta), (\epsilon\eta), (\zeta\theta), (\iota\kappa)$, belong together as regularly given doublets. We call them: **L-doublets**. They are designated by the successive letters of the Greek alphabet. Their characteristic feature is: both lines of an L-doublet have the *same initial level*, the softer line ending in the L_1 -level, the harder one in the L_2 -level.

In all these doublets the softer line of the doublet is the more intense line (this holds for the doublets $\alpha'\beta$ and $\gamma'\delta$ in so far as we take into account the intensity of the two related lines $\alpha\alpha'$ and $\gamma\gamma'$ respectively, for these, together, are then considerably more intense than β or δ respectively).

We call the line-pairs $(\alpha'a)$ and $(\phi'\phi)$ **M-doublets**, because, in them, the related lines have *as their final level the same L-level, but different M-levels as initial levels*. For an equivalent reason, the line-pairs $(\gamma'\gamma)$ and $(\chi'\chi)$ are called **N-doublets**. The M- and N-doublets are made recognisable in Table 12 by brackets placed at the left of their symbols. The symbol for the softer doublet-line is distinguished from that for the harder line only by the accent. In contradistinction to the case of L-doublets, the softer components in the case of the M-doublet $(\alpha'a)$ and the N-doublet $(\gamma'\gamma)$ is the *weaker* component. In the doublets $(\phi'\phi)$ and $(\chi'\chi)$, both of which have L_3 as *final level* (*final* letters of the Greek alphabet), the softer component of the doublet is only inappreciably or not at all weaker than the harder component.

To bring our comments on Table 12 to a close for the present, we have yet to remark that the combination of the L-lines into doublets and the tracing of their origin to common or different initial and final levels has enabled us to get a preliminary survey of the manifold of emissions that is possible.

In Table 13 the more recent precision measurements (Siegbahn, Hjalmar, Coster) may be distinguished from the older measurements (Friman) by the decimal places. The precision measurements for $Z = 29$ to $Z = 73$ are due to E. Hjalmar (Zeitschr. f. Phys., 3, 262, 1920),

those for $Z = 76$ to $Z = 92$ are due to D. Coster (*ibid.*, 4, 178, 1921); tungsten, $Z = 74$, has been measured very carefully by various experimenters. Our numbers are taken from Siegbahn* (Physikal. Zeitschr., 20, 533, 1919); the numbers for θ , χ' , χ in the case of Ta, $Z = 73$, and W, $Z = 74$, have been added in accordance with Coster (Compt. rend., 173, 77, 1921). The older, less exact, observations were given in Friman's dissertation (Lund, 1915; see also Ann. d. Phys., 49, 616, 1916). For the elements, $Z < 74$, we have corrected Friman's values in accordance with the method of Hjalmar, based on his precision measurements of the main lines. (Correspondingly, in Table 10, the wave-lengths of $K\gamma$ have been corrected on the basis of Hjalmar's precision measurements of $K\beta$.) The present gaps which occur particularly among the weaker lines, are for the most part probably of an accidental nature; it cannot yet be stated definitely whether several lines (for example, ϵ and η) cease when we get to the lighter elements.

The hardest and the softest wave-lengths of this table are of the same order of magnitude as the hardest and softest lines of the K-series in Table 10. But of course in this case the same hardness or the same softness occurs at much higher atomic numbers than in the former case. The measurement of the soft wave-lengths demands the same precautions (vacuum spectrograph, gypsum crystal in place of rock-salt) as in the case of the K-series.

A bold incursion into the region of very soft rays has been initiated by Millikan,† not from the side of the Röntgen spectra, but from that of ultra-violet spectra. He makes his observations not with a crystal lattice but with an artificial line grating, the production of which he is systematically improving; he uses high-tension "vacuum sparks." Thus at $\lambda > 360 \text{ \AA}$ he has found lines that he ascribes to the L-series of carbon. We hear that recently, on the one hand, Millikan, on the other, P. D. Foote, has succeeded in extending the measurement of the L-series systematically as far as sodium. Moseley's laws, which, according to Fig. 53, are applicable to the L-series, seem to remain valid as far as this region.

In Table 13 a first characteristic property of our doublet asserts itself. We calculate in each case the differences $\Delta\lambda$ between the wave-lengths of two related doublet lines. We then find as a general result that, throughout the whole series of elements, related doublet lines give *almost equal differences of wave-length* $\Delta\lambda$. Or, expressed more accurately, we combine such and only such lines into doublets as are separated by *almost equal distances* in the scale of wave-lengths.

Let us consider Fig. 52. In it we have plotted our L-doublets ($\epsilon\eta$), ($\alpha'\beta$), ($\gamma\delta$), ($\zeta\theta$), ($\iota\kappa$). The curve ϵ - η lies highest, the curve α' - β lies below it, and so forth, in the order of the hardness of the line-pairs.

* In the case of tungsten, our ζ -line is different from that called β_6 by Siegbahn.

† Astrophys. Journ., 52, 47 and 286 (1920); 53, 150 (1921).

TABLE 13. Wave-lengths.

Z	ϵ	α'	α	η	ϕ'	ι	β
29 Copper	—	—	13309.1	—	—	—	—
30 Zinc	—	—	12222.5	—	—	—	11951
32 Germanium	—	—	10413.6	—	—	—	—
33 Arsenic	—	—	9650.3	—	—	—	9391.0
34 Selenium	—	—	8970.6	—	—	—	8717.2
35 Bromine	—	—	8356.6	—	—	—	8107.6
37 Rubidium	—	—	7302.7	—	—	—	7060.4
38 Strontium	—	—	6847.8	—	—	—	6609.2
39 Yttrium	—	—	6434.9	—	—	—	6198.4
40 Zirconium	—	—	6055.9	—	—	—	5822.8
41 Niobium	—	5717	5711.3	—	—	—	5479.6
42 Molybdenum	—	5400	5394.3	—	—	—	5165.8
44 Ruthenium	—	4843.67	4835.67	—	—	—	4611.00
45 Rhodium	—	4595.56	4587.78	—	—	—	4364.90
46 Palladium	—	4366.60	4358.50	—	4065	—	4137.30
47 Silver	—	4153.82	4145.64	—	3861.09	—	3926.64
48 Cadmium	—	3956.36	3947.82	—	3671.25	—	3730.08
49 Indium	—	3772.42	3763.67	—	—	—	3547.83
50 Tin	—	3600.83	3591.93	—	3333	—	3377.62
51 Antimony	—	3440.75	3431.77	—	3181	—	3218.36
52 Tellurium	—	3290.70	3281.69	—	3039.71	—	3069.64
53 Iodine	—	3150.57	3141.36	—	2906	—	2930.60
55 Caesium	—	2895.27	2885.87	—	2660.19	—	2677.50
56 Barium	—	2778.69	2769.31	—	2549.76	—	2562.24
57 Lanthanum	—	2668.56	2659.31	—	2443.90	—	2452.94
58 Cerium	—	2564.76	2555.59	—	2315.11	—	2350.61
59 Praseodymium	—	2467.28	2457.35	—	2251	—	2253.53
60 Neodymium	—	2375.26	2364.94	—	2162	—	2161.81
62 Samarium	—	2205.30	2194.63	—	—	—	1993.17
63 Europium	—	2126.95	2115.95	—	1921	—	1915.91
64 Gadolinium	—	2052.24	2041.55	—	1848	—	1842.08
65 Terbium	—	1981.91	1971.09	1933	1781	—	1772.28
66 Dysprosium	—	1915.22	1904.18	—	1718	—	1706.16
67 Holmium	—	1851.65	1840.57	—	1653	—	1643.12
68 Erbium	—	1791.00	1780.00	1722	1596	—	1583.04
70 Aldebaranium	1830	1678.5	1667.39	1616	1488	—	1472
71 Cassiopeium	1830	1625.96	1615.11	—	1434	—	1417
73 Tantalum	—	1528.90	1517.71	1433	1341	—	1323.12
74 Tungsten	1675.05	1484.52	1473.48	1417.7	1293.74	1287.1	1279.17
76 Osmium	—	1398.2	1388.16	—	1215.0	1204.8	1194.59
77 Iridium	—	1359.39	1348.34	—	1176.4	1171.7	1154.95
78 Platinum	1497.23	1321.21	1310.08	1240.1	1139.8	1139.8	1117.22
79 Gold	1456.54	1284.89	1273.55	1199.5	1104.4	1110.6	1080.93
81 Thallium	—	1216.03	1204.71	1125	1037.1	1048.0	1012.66
82 Lead	1344.54	1183.52	1172.02	1087	1004.69	1018.8	979.90
83 Bismuth	1312.95	1153.3	1141.15	1057	975.4	991.6	949.30
90 Thorium	1112.41	965.24	953.42	—	789	826.2	762.59
92 Uranium	1064.77	920.14	908.33	802.9	745.4	786.56	718.07

But within each curve the $\Delta\lambda$'s are almost constant for the whole system of elements from $Z = 40$ to $Z = 92$ (axis of abscissæ); there is just a slight decrease as we pass from lower to higher atomic numbers.

The $\Delta\lambda$'s of our M-doublets ($\alpha'\alpha$) and ($\phi'\phi$) are much more constant still. The graphical curves $\alpha'-\alpha$ and $\phi'-\phi$ run almost exactly parallel to the abscissa-axis, the first at a distance of 40 X-units, the second at a

of the L-series (in X-units)

ϕ	γ	ζ	κ	δ	θ	χ'	χ	ψ
—	—	—	—	—	—	—	—	—
—	—	—	—	—	—	—	—	—
—	—	—	—	—	—	—	—	—
—	—	—	—	—	—	—	—	—
—	—	—	—	—	—	—	—	—
—	—	—	—	—	—	—	—	—
—	—	—	—	—	—	—	—	—
—	—	—	—	—	—	—	—	—
—	—	—	—	—	—	—	—	—
—	5295.1	—	—	—	—	—	—	—
—	—	—	—	4711.1	—	—	—	—
—	—	—	—	4172.82	—	—	—	—
—	—	—	—	3935.7	—	—	—	—
4025	3899	—	—	3716.36	—	3594	—	—
3824.45	3693.83	—	—	3514.85	—	—	—	—
3636.42	3507	—	—	3328.00	—	—	—	—
—	3332	—	—	3155.29	—	—	—	—
3297.38	3168.54	—	—	2994.60	—	2897	2885	2827
3145.14	3017	—	—	2845.07	—	2779	—	—
3001.00	2877	—	—	2706.13	—	—	—	—
2867	2745.75	—	—	2577.12	—	—	—	—
2622.59	2507	—	—	2342.17	—	2244	—	—
2511.00	2399.28	—	—	2236.25	—	—	—	—
2404.95	2298	—	—	2136.80	—	—	—	—
2304.58	2203	—	—	2044	—	1995	—	—
2212.00	2114.31	—	—	1956.41	—	1931.39	1925.54	—
2121.90	2031	—	—	1873.43	—	1801	—	1773
1958	1877	—	—	1722.69	—	1657	—	—
1886	1807	—	—	1659	—	1598	1588	—
1809	1741	—	—	1588.22	—	1554	1549	—
1742.16	1678.85	1656	—	1529	—	1474	1468	1434
1680	1619.33	—	—	1467	—	1419	1415	—
1616.37	1563.25	—	—	1412	—	1366	1361	—
1556	1510.8	—	—	1363	—	1320	1313	—
1448	1412	—	—	1265	—	1225	1221	—
1395	1366	—	—	1220	—	1184	1180	—
1303	1280.35	—	—	1134	1110.0	1102.0	1096.2	—
1260.00	1241.91	1213.3	1128.4	1095.53	1072.0	1065.84	1059.69	1026.47
1177.2	1168.38	1140	—	1022.47	—	—	—	—
1137.9	1132.87	1103.0	—	988.41	963.6	963.6	956.6	—
1099.50	1099.50	1070.1	984	955.45	931.7	931.7	925.6	895.0
1060.9	1067.75	1038.2	—	924.37	901.25	901.25	895.68	866.3
997.8	1007.86	978.3	854.2	865.29	841.7	844.7	837.9	810.0
966.02	979.90	949.52	866	837.08	813.70	818.2	813.70	783.6
935.7	952.93	922.3	837.8	810.65	787.4	792.9	787.4	761
752.1	791.08	762.59	—	651.03	630.1	—	—	—
708.4	752.68	724.13	—	612.83	592.6	604.4	597.0	573.8

distance of (10 ± 1) X-units. In the same way $\chi' - \chi$ is almost a constant and equal to about 5 X-units: on account of the smallness of this difference the corresponding graphical curve could not be shown in Fig. 52. The difference $\gamma' - \gamma$ is still smaller (about 1.5 X-units). Since the levels N_3 and N_4 are separated by only an extremely small distance, the lines γ' and γ are so near to one another that only in the case of uranium could

it be shown that they are distinct lines (cf. A. Dauvillier, *Compt. rend.*, **172**, 1350 (1921)). But (with the help of the complete scheme of the lines, § 6, Chap. VIII) the distance between them may be calculated indirectly and is then also shown to be constant. Since γ' and γ differ only imperceptibly from one another, we were justified in Fig. 52 in replacing the difference $\gamma' - \delta$ by the difference $\gamma - \delta$. The existence of a soft associate γ' for γ was first postulated by the author as a necessity for the completeness of the system.

In Table 14 we pass on from values of λ to values of $\frac{\nu}{R}$ ($\nu = \frac{1}{\lambda}$, cf. eqn. (3) on p. 154; $R = 109737 \text{ cms.}^{-1}$, cf. eqn. (5) on p. 155), with which the later investigations will be concerned.

Before we deduce from this table the relationships between the lines, we shall consider a graphical representation (Fig. 53) of the values of $\sqrt{\frac{\nu}{R}}$, similar to that given in Fig. 51. To prevent confusing the figure

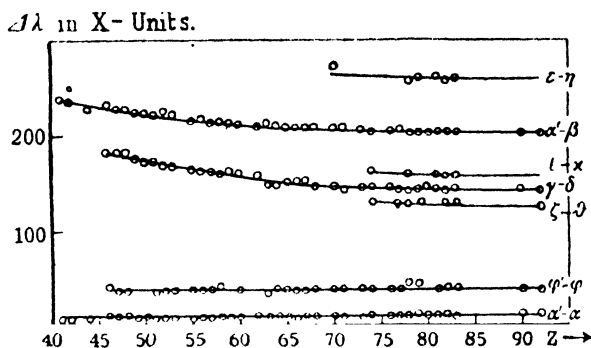

FIG. 52.

we shall restrict ourselves to the lines α , β , γ , δ , ϵ , η , ϕ . The atomic numbers are again plotted as abscissae. Here, too, the course of the lines traced is essentially *rectilinear*, which indicates that ν increases nearly proportionately with Z^2 . The curvature of the lines, however, is greater than before, particularly in the case of the line δ . This is on account of the "relativity correction" mentioned on page 158. Furthermore, we see in the figure the overlapping which was mentioned earlier and which was found to be absent in the K-series. The line β cuts the line γ at Pb, $Z = 82$; beyond 82, it is harder than γ : below 82, it is softer. Moreover, ϕ and γ intersect at Pt, $Z = 78$. From this we see that the relationship between the lines is not so simple and rigorous as in the case of the lines of the K-series.

In Table 14 the L-doublets are again distinguished by a characteristic property. We have calculated the differences $\frac{\Delta\nu}{R}$ of the values of $\frac{\nu}{R}$ for all related doublet-lines and have tabulated them in Table 15. If, this

time, we compare, *not* the doublets of *different elements*, but the different L-doublets of the same element, we learn from Table 15 that all of them have, within the limits of error, *the same difference* $\frac{\Delta\nu}{R}$, that is :

$$\beta - \alpha' = \delta - \gamma' = \eta - \epsilon = \theta - \zeta = \kappa - \iota .$$

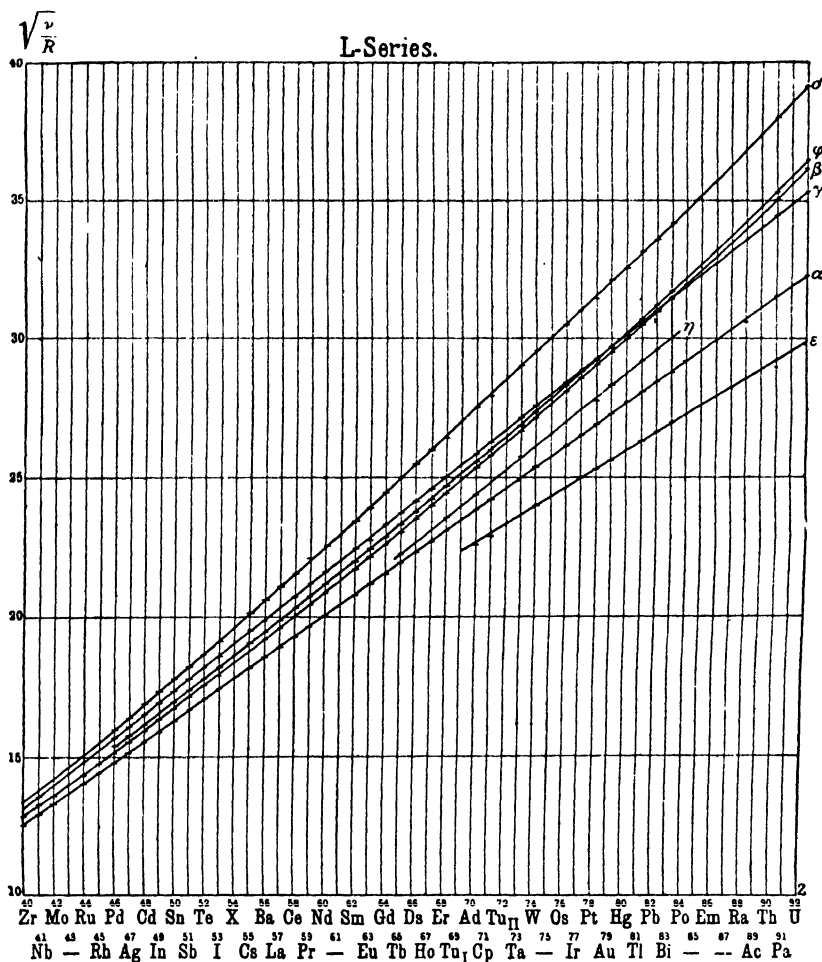

FIG. 53.

Unfortunately, as mentioned above, γ' has been measured as distinct from γ only in the case of uranium; hence it is only possible to show that $\delta - \gamma$ *nearly* agrees with the other differences of wave-length. In reality $\delta - \gamma$ is slightly smaller than the latter and than $\delta - \gamma'$. The distance between the lines $\beta - \alpha$ (Table 15, first column) differs noticeably more from the doublet differences $\beta - \alpha'$, and, indeed, for the same reason as

Z	ϵ	α'	α	η	ϕ'	ι	β
29 Cu	—	—	68.47	—	—	—	—
30 Zn	—	—	74.55	—	—	—	76.25
32 Ge	—	—	87.50	—	—	—	—
33 As	—	—	94.42	—	—	—	97.00
34 Se	—	—	101.58	—	—	—	104.53
35 Br	—	—	109.04	—	—	—	112.39
37 Rb	—	—	124.78	—	—	—	129.06
38 Sr	—	—	133.07	—	—	—	137.87
39 Y	—	—	141.61	—	—	—	147.01
40 Zr	—	—	150.47	—	—	—	156.50
41 Nb	—	159.4	159.55	—	—	—	166.29
42 Mo	—	168.7	168.93	—	—	—	176.40
44 Ru	—	188.13	188.44	—	—	—	197.62
45 Rh	—	198.29	198.62	—	—	—	208.77
46 Pd	—	208.69	209.07	—	224.1	—	220.25
47 Ag	—	219.37	219.80	—	236.01	—	232.06
48 Cd	—	230.32	230.82	—	248.00	—	244.29
49 In	—	241.55	242.12	—	—	—	256.74
50 Sn	—	253.06	253.69	—	273.4	—	269.79
51 Sb	—	264.84	265.53	—	286.5	—	283.13
52 Te	—	276.91	277.67	—	299.77	—	296.85
53 J.	—	289.23	290.07	—	313.6	—	310.94
55 Cs	—	314.73	315.76	—	342.55	—	340.33
56 Ba	—	327.94	329.05	—	357.38	—	355.64
57 La	—	341.47	342.66	—	372.86	—	371.48
58 Ce	—	355.28	356.57	—	388.57	—	387.66
59 Pr	—	369.33	370.82	—	404.3	—	404.36
60 Nd	—	383.64	385.31	—	421.5	—	421.50
62 Sm	—	413.22	415.21	—	—	—	457.17
63 Eu	—	428.42	430.65	—	474.4	—	475.61
64 Gd	—	444.02	446.34	—	493.0	—	494.68
65 Th	—	459.78	462.30	471.4	511.6	—	514.16
66 Dy	—	475.79	478.54	—	530.5	—	534.09
67 Ho	—	492.12	495.09	—	551.3	—	551.58
68 Er	—	508.78	511.93	529.2	571.1	—	575.63
70 Ad	482.2	542.90	546.51	563.9	612.5	—	619.0
71 Cp	498.0	560.43	564.20	635.9	635.6	—	642.9
73 Ta	—	596.00	600.40	—	679.6	—	688.70
74 W	544.02	613.85	618.45	642.78	701.66	708.03	712.39
76 Os	—	651.80	656.45	—	748.25	756.33	762.33
77 Ir	—	670.35	675.84	—	774.62	777.75	788.99
78 Pt	608.64	689.73	695.58	734.82	799.52	799.52	815.65
79 Au	625.63	709.22	715.53	759.97	825.15	820.51	843.02
81 Tl	—	749.39	756.42	810.30	878.61	869.49	899.88
82 Pb	677.75	769.96	777.51	838.26	907.01	894.50	929.98
83 Bi	691.07	790.20	798.54	862.32	934.22	918.97	959.93
90 Th	819.19	944.08	955.78	—	1155.00	1102.78	1194.94
92 U.	855.81	990.37	1003.23	1134.95	1222.53	1158.70	1269.08

does δ - γ ; this will become evident in Fig. 55. It is very striking that the β -line, as the second most intense line of the L-series, forms the characteristic doublet difference not with α , the most intense line, but with α' , its weak associate. We must remark, however, that we shall also find this phenomenon to be characteristic of the visible region (cf. § 5, Chap. VI, for the case of the so-called "composite doublets"; there, too,

ν/R -values of the L-series

ϕ	γ	ζ	κ	δ	θ	χ'	χ	ψ
—	—	—	—	—	—	—	—	—
—	—	—	—	—	—	—	—	—
—	—	—	—	—	—	—	—	—
—	—	—	—	—	—	—	—	—
—	—	—	—	—	—	—	—	—
—	—	—	—	—	—	—	—	—
—	—	—	—	—	—	—	—	—
—	—	—	—	—	—	—	—	—
—	172.09	—	—	—	—	—	—	—
—	—	—	—	193.42	—	—	—	—
—	—	—	—	218.38	—	—	—	—
—	—	—	—	231.53	—	—	—	—
—	—	—	—	245.19	—	—	—	—
226.4	233.7	—	—	259.15	—	253.6	—	—
238.27	246.69	—	—	273.81	—	—	—	—
250.59	259.8	—	—	288.79	—	—	—	—
—	273.5	—	—	304.29	—	—	—	—
276.35	287.59	—	—	320.29	—	314.6	315.8	322.3
289.73	302.0	—	—	336.73	—	—	328.0	—
303.65	316.7	—	—	353.59	—	—	—	—
317.8	331.87	—	—	389.05	—	—	—	—
347.46	363.5	—	—	407.48	—	406.1	—	—
362.89	379.80	—	—	426.45	—	—	—	—
378.90	396.5	—	—	445.8	—	—	—	—
395.40	413.6	—	—	465.77	—	456.8	—	—
412.14	431.00	—	—	486.40	—	471.80	473.29	—
429.44	448.8	—	—	528.96	—	—	506.2	514.0
465.4	485.5	—	—	519.2	—	550.1	—	—
483.2	504.3	—	—	573.75	—	570.1	573.8	—
503.8	523.3	—	—	596.1	—	586.5	588.3	—
523.05	542.78	550.2	—	621.2	—	618.2	620.9	635.2
542.6	562.71	—	—	645.4	—	642.2	644.0	—
563.75	582.91	—	—	668.4	—	667.3	669.3	—
585.5	603.16	—	—	720.4	—	690.5	694.0	—
629.1	645.4	—	—	746.9	—	743.6	746.2	—
653.1	667.2	—	—	803.7	820.96	769.6	772.5	—
699.4	711.70	—	—	831.81	850.07	826.92	831.30	—
723.23	733.76	751.07	807.57	891.25	—	854.98	859.94	887.77
774.08	780.58	799.65	—	921.96	915.69	—	—	—
800.82	804.39	826.18	—	953.77	978.07	945.69	952.64	—
828.80	828.80	851.57	926.20	985.83	1011.12	978.07	984.52	1018.17
858.94	853.46	877.70	—	1053.12	1082.65	1011.12	1017.41	1051.86
913.23	904.16	931.47	1019.14	1088.37	1119.97	1078.81	1087.56	1125.00
943.30	929.98	959.72	1052.57	1124.10	1157.55	1113.75	1119.97	1162.89
973.85	956.28	987.98	1087.75	1399.74	1446.20	1149.20	1157.55	1196.89
1211.67	1151.93	1194.94	—	1486.98	1537.45	—	—	—
1286.29	1210.70	1258.43	—	—	—	1507.73	1526.42	1588

the weak associate of the principal line, not the latter itself, forms a doublet with a second line).

The distances between both the components of M-doublets and those of the N-doublets are not related among themselves, nor are they related to the distance which separates the components of the L-doublet.

In the last column of Table 15 the fourth roots of the characteristic

TABLE 15

Element	$\beta-\alpha$	$\beta-\alpha'$	$\delta-\gamma$	$\eta-\epsilon$	$\theta-\zeta$	$\kappa-\iota$	$\alpha-\alpha'$	$\phi-\phi'$	$\chi-\chi'$	$\sqrt[4]{\beta-\alpha'}$
41 Nb	6.74	6.89	—	—	—	—	0.15	—	—	1.620
42 Mo	7.47	7.70	—	—	—	—	0.23	—	—	1.666
44 Ru	9.18	9.49	—	—	—	—	0.31	—	—	1.755
45 Rh	10.15	10.48	—	—	—	—	0.33	—	—	1.799
46 Pd	11.18	11.56	11.5	—	—	—	0.38	2.3	—	1.844
47 Ag	12.26	12.69	12.46	—	—	—	0.43	2.26	—	1.887
48 Cd	13.47	13.97	14.0	—	—	—	0.50	2.59	—	1.933
49 In	14.72	15.29	15.3	—	—	—	0.57	—	—	1.977
50 Sn	16.10	16.73	16.70	—	—	—	0.63	3.0	1.2	2.022
51 Sb	17.60	18.29	18.3	—	—	—	0.69	3.2	—	2.068
52 Te	19.18	19.94	20.0	—	—	—	0.76	3.88	—	2.113
53 J	20.87	21.71	21.72	—	—	—	0.84	4.2	—	2.159
55 Cs	24.57	25.60	25.6	—	—	—	1.08	4.91	—	2.249
56 Ba	26.59	27.70	27.68	—	—	—	1.11	5.51	—	2.294
57 La	28.82	30.01	30.0	—	—	—	1.19	6.04	—	2.341
58 Ce	31.09	32.38	32.2	—	—	—	1.29	6.83	—	2.385
59 Pr	33.54	35.03	34.77	—	—	—	1.49	7.8	1.19	2.433
60 Nd	36.19	37.86	37.6	—	—	—	1.67	7.9	—	2.481
62 Sm	41.96	43.95	43.5	—	—	—	1.99	—	—	2.575
63 Eu	44.96	47.19	44.9	—	—	—	2.23	8.8	3.7	2.621
64 Gd	48.34	50.66	50.5	—	—	—	2.32	10.8	1.8	2.668
65 Tb	51.86	54.38	53.3	—	—	—	2.52	11.4	2.7	2.716
66 Dy	55.55	58.30	58.5	—	—	—	2.75	12.1	1.8	2.763
67 Ho	59.49	62.46	62.5	—	—	—	2.97	12.5	2.0	2.811
68 Er	63.70	66.85	65.2	—	—	—	3.15	14.1	3.5	2.859
70 Yb	72.5	76.1	75.0	81.7(?)	—	—	3.61	16.6	2.6	2.954
71 Lu	78.7	82.5	79.7	—	—	—	3.77	17.8	2.9	3.01
73 Ta	88.30	92.70	92.0	—	—	—	4.40	19.8	4.38	3.10
74 W	93.94	98.54	98.05	98.76	99.00	99.54	4.60	21.57	4.96	3.151
76 Os	106.38	111.08	110.67	—	—	—	4.7	25.83	—	3.246
77 Ir	113.15	118.64	117.57	—	119.54	—	5.49	26.20	6.95	3.300
78 Pt	120.07	125.92	124.97	126.18	126.50	126.68	5.85	29.28	6.15	3.350
79 Au	127.49	133.80	132.37	134.34	133.42	—	6.31	33.79	6.29	3.401
81 Tl	143.46	150.49	148.96	—	151.18	149.65	7.03	34.59	8.75	3.502
82 Pb	152.47	160.02	158.39	160.51	160.25	158.07	7.55	36.30	6.22	3.557
83 Bi	161.39	169.73	167.82	168.25	169.57	168.78	8.3	39.63	8.75	3.609
90 Th	239.16	250.86	247.81	—	251.26	—	11.70	56.67	—	3.980
92 U	265.85	278.71	276.28	279.11	279.02	281	12.86	63.76	18.69	4.086

difference of the L-doublets, $\frac{\Delta\nu}{R} = \beta - \alpha'$, are given. These form an arithmetic series, as may easily be confirmed. As Z increases, these numbers increase steadily by a constant amount of about 0.043. The particular interest which attaches to this at present empirical fact will be referred to at the end of this section. The fourth roots of the M- and N-doublet-distances also increase linearly with Z .

Fig. 54 shows for several selected cases how the L-, M-, and N-doublets overlap and alter their relative distances as Z increases (corresponding to the intersections of Fig. 53). Each individual spectrum of our series has been drawn in the scale of ν (not of λ), as it is in this scale alone that the equality of the distances between the components of the doublets (doublet-distances) come into evidence. But the ratio of the scales of the super-

posed spectra has been chosen so that the L-doublets are equal in each case, as actually occurs when we compare real spectral photographs of different elements.

Now, the law of the constancy of the differences in wave-length immediately becomes clear if we accept the assumptions that were made in Table 12 about the origin of the lines. According to these assumptions two associated lines of an L-doublet differ only in their final level (L_1 or L_2). As a matter of fact, the β -, δ -, η -, θ -, κ -lines are *harder* than the α -, γ -, or α' -, γ' -, ϵ -, ζ -, ι -lines, respectively; the difference of energy that corresponds to the former is greater than that corresponding to the latter (L_2 -level is lower than the L_1 -level), and hence has also a greater wave-

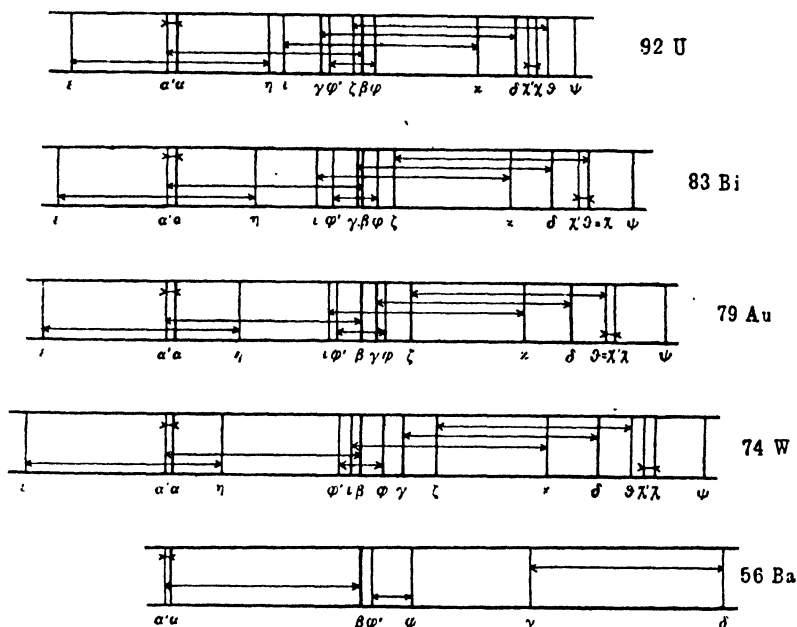

FIG. 54.

length. The differences of hardness between the associated line-pairs (α/β), (γ/δ), (ϵ/η), (ζ/θ), (ι/κ), however, are equal; they are represented, independently of the initial level of the transition in question, by the fixed difference of level between the L_1 - and the L_2 -shell. The α -, γ -, ϵ -, ζ -, ι -lines are also more intense than the β -, δ -, η -, θ -, κ -lines; clearly, to the former there corresponds a greater probability of transition. The (so to speak) normal L_1 -level is attained more often as the final position than the L_2 -level.

But if an electron can pass to the L_2 - as well as to the L_1 -shell from a higher level, then it will also be able to pass from the L_2 -level as well as from the L_1 -level to the lower K-level. But the transition $L_1 \rightarrow K$ denoted

the line $K\alpha$. We see now that this line must be a *doublet*, and we understand the origin of the line $K\alpha'$ that has already been indicated in Table 9 on page 150, and that is illustrated in detail in Fig. 55. (Concerning the description of this figure, see also p. 175.) *Evidently, in accordance with our theory, the doublet-interval ($\alpha'\alpha$) in the K-series must be equal to the doublet-interval ($\alpha'\beta$) in the L-series, and hence also to the remaining*

L-doublets ($\gamma'\delta$), ($\epsilon\eta$), ($\zeta\theta$), ($\iota\kappa$)—of course, all measured in terms of ν or $\frac{\nu}{R}$ respectively. Actually, this interval is determined in all cases by the difference of energy between the L_1 -level and the L_2 -level in our figure. On the other hand, the interval between the lines $L\alpha$ and $L\beta$ that form no true L-doublet, measured in wave-numbers, is less than (L_1L_2). Our figure also tells us that the line $K\alpha'$, starting from the less probable energy-level L_2 , is weaker than the line $K\alpha$, starting from the L_1 -level, just as the line $L\beta$, directed at the L_2 -level, was weaker than the line $L\alpha$

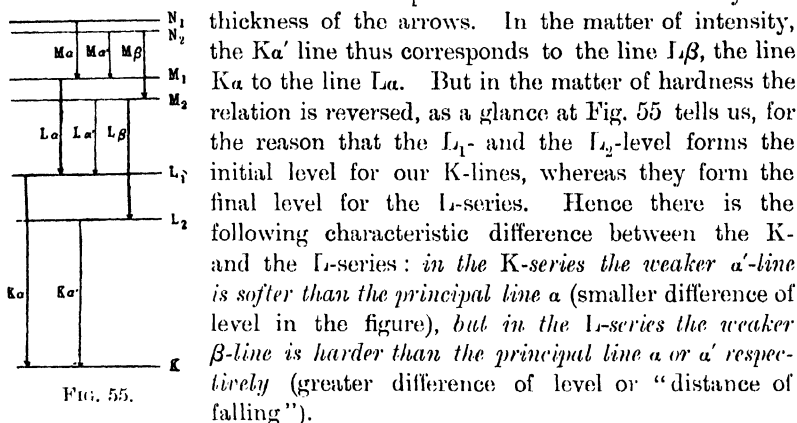

FIG. 55.

directed at the L_1 -level. This is indicated by the thickness of the arrows. In the matter of intensity, the $K\alpha'$ line thus corresponds to the line $L\beta$, the line $K\alpha$ to the line $L\alpha$. But in the matter of hardness the relation is reversed, as a glance at Fig. 55 tells us, for the reason that the L_1 - and the L_2 -level forms the initial level for our K-lines, whereas they form the final level for the L-series. Hence there is the following characteristic difference between the K- and the L-series: *in the K-series the weaker α' -line is softer than the principal line α (smaller difference of level in the figure), but in the L-series the weaker β -line is harder than the principal line α or α' respectively (greater difference of level or "distance of falling")*.

As we know, this qualitative theoretical deduction agrees perfectly with the facts of observation. But the quantitative deduction that the doublet-intervals ($\alpha'\alpha$) in the K-series are equal to that of the "L-doublet" in the L-series is fully confirmed by the measurements. Certainly, the measurements of the relatively small difference of hardness ($\alpha\alpha'$) in the hard K-series is comparatively inexact, being much more uncertain than the measurements of the differences of hardness in the L-doublet of the L-series. To be certain of our quantitative deductions we must therefore restrict ourselves to the few elements for which precision measurements of the K-lines are available and for which the L-series is also known. These elements number only three: Mo, Rh, and W. In their cases, however, the agreement is perfect, as is shown by Table 16.

In the case of the remaining elements only an average equality may be expected. The confirmation of this is given in Fig. 56. It contains, besides tungsten, all elements (between $Z = 41$ and $Z = 60$) for which

TABLE 16

	42 Mo	45 Rh	74 W
$(\alpha'\alpha)_K$	7.75	10.3	98.5
$(\alpha'\beta)_L$	7.7	10.48	98.54

the measurements of the K-series and of the L-series extend beyond one another, and for which, in addition to the K-doublet, at least one L-doublet has been measured. The values of $\frac{\Delta\nu_K}{R}$ denoted by x have been formed from Table 11 as the difference of the $\frac{\nu}{R}$ values for $K\alpha$ and $K\alpha'$; the values of $\frac{\Delta\nu_L}{R}$ denoted by 0 have been taken from the second column of Table 15.

From Table 10 we see that the K-doublet (or more correctly the L-doublet of the K-series) also obeys the law of constant differences of wave-lengths. In actual fact $\lambda_{\alpha'} - \lambda_{\alpha}$ is constant throughout the whole series of elements and is equal to about 4 or 5 X-units.

We conclude our present provisional statements about the L-series and L-doublets with some historical notes. The law of approximately constant wave-length differences was set up by the author as long ago as 1916,* and

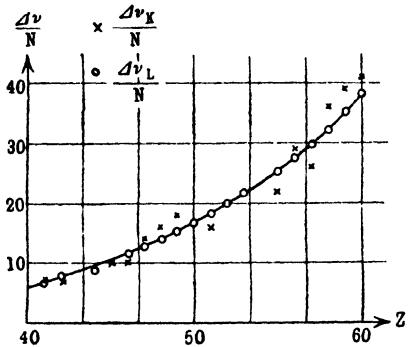

FIG. 56.

was used to arrange into order the lines of the L-series. Further, it furnishes a convenient auxiliary means of finding doublet lines that belong together. Concerning its theoretical grounds we shall soon have something to say. The L-doublets $(\alpha'\beta)$, $(\gamma\delta)$, $(\epsilon\eta)$, $(\zeta\theta)$ were already known earlier as a result of the law of approximately constant differences of wave-length and as a result of their exactly constant differences of frequency for each element. The doublet $(\iota\kappa)$, in the light of more recent measurements, has here been added.

On the other hand, the doublet $(\phi'\phi)$ was previously called $(\nu\phi)$, owing to a false interpretation by the author. For it seemed, according to the measurements then available, that there was the same difference of wave-number between the lines χ and ψ as between ϕ' and ϕ , and hence this difference of wave-number was attributed to a difference of level in the L-shell. The doublets $(\phi'\phi)$ and $(\chi'\psi)$ which were consequently surmised to exist, were called Λ -doublets in contrast to the true

* Ann. d. Phys., 51, 125 (1916), cf., in particular, pp. 137 and 138, from which our Fig. 52 has been taken.

L-doublets. This interpretation was also used in the previous edition of this book. The incorrectness of this view was disclosed by measurements of the L-absorption limits carried out by G. Hertz (cf. the next section), and was confirmed by A. Smekal* and D. Coster† in the improved measurements now available. The two latter physicists set up independently of one another the scheme for the interpretation of the L-lines which we adopted (with unimportant changes) in our Table 12.

We here parenthetically add a few remarks about the Röntgen spectra of *isotopic elements*. Siegbahn and Stenström have photographed the L-series of ordinary lead (at. wgt. 207.2) and of radium lead (RaG, at. wgt. 206) under identical conditions; they found not the slightest difference in the wave-lengths of their L-lines.‡ We had already anticipated this result in Chapter II, § 7 (cf. p. 102) and had concluded that isotopic elements agree in the arrangement of their central electrons. For the same two elements it has also been shown that their visible and ultra-violet spectra are almost exactly identical. From this and from the circumstance that they cannot be separated chemically, we concluded: isotopic elements are also alike in the arrangement of their peripheral electrons.

On the other hand Rutherford and Andrade § have taken photographs of Ra spectra, which they have ascribed to proper or natural γ -radiation, that is to *spontaneous* Röntgen radiation in contrast with the Röntgen radiation that is excited by impinging cathode rays, such as we just now mentioned in the case of RaG. But we may conjecture that here we have essentially the same case as in the previous section, namely, that we are dealing with secondary X-rays that are excited by the β -radiation of Ra. Photographs of the softer part of the spectrum produced wave-lengths which partly coincided with the L-lines of Pb, and partly with those of Bi. This is explained by the theory of isotopes as follows: Ra contains among other things two of its descendants, RaB and RaC, which are isotopes of Pb and Bi respectively; they, therefore, lead to L-spectra that are identical with those of Pb and Bi. In the harder part of the spectrum, on the other hand, Rutherford and Andrade have found wave-lengths that seem to be identical with wave-lengths (hitherto not directly measured, but only obtainable by extrapolation) of the K-series of Pb and Bi. This K-radiation, also, is presumably of a secondary nature. Proper primary γ -radiation is probably essentially harder. Interpreted in this sense, the experiments of Rutherford and Andrade seem to bring nothing new, or nothing that goes beyond the results of the experiments of Siegbahn and Stenström; but like the latter, they represent a beautiful confirmation of the theory of isotopes.

* Zeitschr. f. Phys., 5, 91 and 121 (1921).

+ *Ibid.*, 5, 139 (1921).

‡ Physikal. Zeitschr., 18, 547 (1917). It is of course not out of the question that if the measurements are carried out to an extreme degree of refinement, a very small difference may become manifest, as in the visible region (cf. p. 102, footnote 1).

§ Phil. Mag., 28, 263 (1914).

TABLE 17

Stenstrom	Origin	Intensity
$\left. \begin{matrix} \alpha' \\ \alpha \end{matrix} \right\}$	$N_2 \rightarrow M_1$	1
β	$N_1 \rightarrow M_1$	8
$\left. \begin{matrix} \gamma \\ \delta \end{matrix} \right\}$	$N_2 \rightarrow M_2$	5
ϵ	$N_3 \rightarrow M_3$	1
	$O_3 \rightarrow M_3$	1
	$N_4 \rightarrow M_4$	1

We now come to the third, the softest, series of Röntgen spectra, namely, the M-series discovered by Siegbahn.* Table 17 is to serve as a key to the terminology, origin, and so forth.

TABLE 18

Wave-lengths of the M-series in X-units (Stenström)

Z	α'	α	β	γ	δ	ϵ
66 Ds	—	9509	9313	—	—	—
67 Ho	—	9123	8930	—	—	—
68 Er	—	8770	8561	—	—	—
70 Ad	—	8123	7895	—	—	—
71 Cp	—	7818	7587	—	—	—
73 Ta	—	7237	7011.5	—	—	—
74 W	—	6973	6745	6091	—	—
76 Os	—	6477	6250	—	—	—
77 Ir	—	6245	6029	—	—	—
78 Pt	—	6028	5812	5311	—	—
79 Au	—	5819	5601	5115	—	—
81 Tl	5461	5449.9	5233.4	4802	—	—
82 Pb	5287	5275.1	5064.8	4663.7	—	—
83 Bi	5119	5107.2	4899.3	4523.8	—	—
90 Th	4143	4129.15	3933.3	3656.5	3127	3006
92 U	3916	3901.4	3708.3	3471.4	2943	2813

In Tables 18 and 19 the wave-lengths λ and the wave-numbers $\nu = \frac{1}{\lambda}$ divided by the Rydberg frequency $R = 109737$ are tabulated. The measurements for the elements Tl to U have been carried out more correctly (felspar was the analyser) than those for Ds to Au (for which a crystal of gypsum was used).

The discovery of associated doublet lines is not quite definite owing to the somewhat incomplete nature of the measurements. As we have indicated in Table 17 by brackets and have explained by giving the origin of the lines, $(\alpha'\beta)$ and $(\gamma\epsilon)$ are to be regarded as M-doublets, $(\alpha'\beta)$ in the rigorous sense and $(\gamma\epsilon)$ in the slightly broader sense, analogously to the $(\alpha\beta)$ and $(\gamma\delta)$ lines of the L-series; $(\alpha'a)$ is to be regarded as an N-doublet.

* Siegbahn, Verh. d. Deutschen Physikal. Ges., **18**, 278 (1916); Stenström, Ann. d. Phys., **57**, 347 (1918), and his Dissertation, Lund, 1919.

It is true that neither of these doublets is known for more than five elements. On account of the small numerical difference of the energy-levels in the N-shell, however, the line-pair $a\beta$, which represents no real doublet, differs only imperceptibly from $a'\beta$. Consequently our criterion of almost constant wave-length differences $\Delta\lambda$, by which we associated the doublet lines in the L-series, holds here approximately as well for the line-pair $(a\beta)$ as for $(a'\beta)$; of this we may convince ourselves in Table 18. In the case of those elements in which a' is not separate from a , $(a\beta)$ is to be regarded as a doublet in the same sense as $(\lambda\epsilon)_M$, $(a\beta)_L$, and $(\gamma\delta)_L$.

TABLE 19
 ν/R -values of the M-series (Stenström)

Z	a'	a	β	γ	δ	ϵ
66 Ds	—	95·83	97·85	—	—	—
67 Ho	—	99·88	102·0	—	—	—
68 Er	—	103·9	106·4	—	—	—
70 Yb	—	112·2	115·4	—	—	—
71 Lu	—	116·6	120·1	—	—	—
73 Ta	—	125·9	130·0	—	—	—
74 W	—	130·7	135·1	149·6	—	—
76 Os	—	140·7	145·8	—	—	—
77 Ir	—	145·9	151·1	—	—	—
78 Pt	—	151·2	156·8	171·6	—	—
79 Au	—	156·6	162·7	178·2	—	—
81 Tl	166·9	167·21	173·96	189·8	—	—
82 Pb	172·4	172·75	179·92	195·40	—	—
83 Bi	178·0	178·43	186·00	201·44	—	—
90 Th	220·0	220·70	231·68	249·22	291·4	303·1
92 U	232·7	233·58	245·75	262·51	309·6	323·9

Towards clearing up the mutual relationships between the L- and the M-series, the following remark of R. Swinne is of particular interest.* *The difference $\beta' - a$ in the M-series is equal to the difference $a - a'$ in the L-series.* Table 20 shows to what extent this equality holds; the numbers again denote the $\frac{\Delta\nu}{R}$ values of the line-pairs written at the top. In the case of elements for which Ma' could not be measured separately, $(a'\beta)_M$ is replaced by $(a\beta)_M$.

We thus find the *same relationship to hold between the M- and the L-series as previously between the L- and the K-series.* Our nomenclature has been chosen so that this relationship is brought into clear evidence.

Namely, $(a'\beta)_M = (a'a)_L$
is fully analogous to

$$(a'\beta)_L = (a'a)_K$$

* Physikal. Zeitschr., 17, 485 (1916). Swinne here compares the doublets $(a'a)_L$ and $(a\beta)_M$. It was pointed out by the author in Zeitschr. f. Phys., 1, 135 (1920), that it is more accurate and more logical to replace $(a\beta)_M$ by $(a'\beta)_M$.

TABLE 20

Z	$(\alpha'\beta)_M$	$(\alpha'a)_L$	Z	$(\alpha'\beta)_M$	$(\alpha'a)_L$
66 Ds . . .	2.02	2.75	77 Ir . . .	5.2	5.49
67 Ho . . .	2.16	2.97	78 Pt . . .	5.6	5.85
68 Er . . .	2.6	3.15	79 Au . . .	6.1	6.31
70 Ad . . .	3.2	3.61	81 Tl . . .	7.09	7.03
71 Cp . . .	3.5	3.77	82 Pb . . .	7.61	7.55
73 Ta . . .	4.1	4.40	83 Bi . . .	8.00	8.34
74 W . . .	4.4	4.60	90 Th . . .	11.68	11.70
76 Os . . .	5.1	4.7	92 U . . .	12.92	12.86

We see the reason of this directly from Fig. 55. Here we have represented the two highest M-levels, M_1 and M_2 (we were able to suppress the lower levels, M_3 , M_4 , and M_5 , which occurred in Tables 12 and 17), just as we have drawn only the two highest levels L_1 , L_2 (omitting the lowest level L_3). Finally, the N-shell, too, is represented only by its two highest levels N_1 , N_2 . If an electron sinks from one of these two N-levels into the M-shell, giving rise to the emission of a line of the M-series, it may stop at the M_1 -level or at the M_2 -level. In the latter case the emitted line ($M\beta$) is harder than that of the former case (Ma or Ma'). Thereby the difference of wave-length of the lines Ma and $M\beta$ becomes nearly equal to the difference of level of the energy-levels M_1 and M_2 , whilst the difference of wave-length of the lines Ma' and $M\beta$ becomes exactly equal to this difference of levels. We see that actually, in Table 17 and Fig. 55, Ma' and $M\beta$ start out from the same initial level N_2 , and Ma and $M\beta$, on the other hand, start out from the two somewhat different energy-levels N_1 and N_2 . We may now again allow the electron to sink further from M_1 or M_2 to L_1 , whereby the line-pair (aa') of the L-series is produced, having the same doublet interval as that given by M_1M_2 . At the same time the same characteristic reversal of hardness and intensity occurs as between the corresponding lines in the L- and the K-series: *whereas in the M-series the weaker line β lies on the "hard" side of α , in the L-series the weaker line a' lies on the soft side of the principal line a .*

We see that in spite of complicated and manifold conditions the structure of atoms and its reflection in the structure of X-ray spectra is marked by wonderful uniformity and logical consistency.

These general considerations may be concluded by some preliminary remarks on the quantitative theory of the X-ray doublets, just as we closed the preceding section by a preliminary remark of a quantitative nature, namely, Moseley's formula for $K\alpha$.

From the definition of wave-number

$$\nu = \frac{1}{\lambda}$$

there follows, for the doublet interval measured in wave-numbers,

$$\Delta\nu = \frac{1}{\lambda_2} - \frac{1}{\lambda_1} = \frac{\Delta\lambda}{\lambda_1\lambda_2}.$$

Taking ν as a mean wave-number for the two doublet lines, we write

$$\Delta\nu = \Delta\lambda \cdot \nu^2 \quad . \quad . \quad . \quad . \quad . \quad (1)$$

We next use the law that for each true doublet the difference of wavelength $\Delta\lambda$ of its members is constant, that is, independent of Z . For example, if we set $\Delta\lambda = a^4$, we get, by taking the fourth root,

$$\sqrt[4]{\Delta\nu} = a \sqrt{\nu} \quad . \quad . \quad . \quad . \quad . \quad (2)$$

By the last column of Table 15 the left side is a linear function of Z ; according to Moseley's law the same is true of the right side, and, indeed, not only for the line $K\alpha$ but also for the other K -, L -, and M -lines.

So far our empirical data in Table 15, combined with Moseley's law, state no more than the law of the approximate constancy of $\Delta\lambda$, which we here used as our basis. But for the case of our L -doublets ($\alpha'\beta$), ($\gamma\delta$), etc., we may now insert numerical values in equation (2) on the ground of our empirical Table 15. As already remarked in connexion with this table, $\sqrt[4]{\Delta\nu}/R$ increases by 0.043 for each increase of Z by one unit. Furthermore, from the last column of Table 15 we may derive that value of Z for which $\Delta\nu$ would vanish, if we extrapolate the rectilinear law that holds for greater Z 's. In this way we get $Z = 3.5$. Consequently the equation (2) may be rewritten in the form

$$\sqrt[4]{\frac{\Delta\nu}{R}} = 0.043(Z - 3.5) \quad . \quad . \quad . \quad . \quad (3)$$

If we raise both sides to the fourth power and, for the sake of convenience multiply the numerator and the denominator by 2^4 , we get

$$\frac{\Delta\nu}{R} = \frac{5.3 \cdot 10^{-5}}{2^4} (Z - 3.5)^4 \quad . \quad . \quad . \quad . \quad (4)$$

This law gives us a deep glimpse into the mechanics of the interior of the atom. It points very definitely not only to the rules of the quantum theory that reign in the interior of the atom (Chap. IV), but also to the laws of the theory of relativity (Chap. VIII). *Whereas the wave-numbers themselves increase, according to Moseley, proportionally to the square of the atomic number, the wave-length differences of the doublets depend on the fourth power of the atomic number.* This is true not only of the L -doublets, as here derived, but also of all other regular doublets, for example, the M -doublet ($\alpha'a$) of the L -series or the similar doublet ($\alpha'\beta$) of the M -series. In the latter case the denominator 2^4 is only to be replaced by $2 \cdot 3^4$, and the number 3.5 is to be replaced by a greater number which is to be determined experimentally. The law that $\Delta\lambda$ is nearly constant for all

such doublets now follows directly from equation (1). Since $\Delta\lambda$ is here represented as the quotient of a bi-quadratic function by the square of a quadratic function of Z , it becomes appreciably independent of Z for greater values of Z .

In conclusion we must add a word about the troublesome question of nomenclature. All terms used to describe physical quantities are arbitrary and too narrow in view of the manifold character of Nature. Our nomenclature, which is intended to be no more than an extension of Moseley's, has the advantage of being systematic to a certain degree and of allowing a fairly easy survey of details. But, for example, in the L-series, it soon reaches the limit at which the Greek letters no longer suffice, when new lines are observed, and would be demolished if lines that have been observed earlier were to receive a new interpretation. On the other hand, Siegbahn's nomenclature has the undeniable advantage that it has any number of indices at its disposal for the inclusion of new lines, and also that the lines whose intensity is to be estimated, for example, the α - (or the β -, γ -) group mostly occur on the same plate. But it is a little difficult to remember and does not give an easy survey.

There is, however, one way of escape which the spectroscopy of the visible region prescribes to us, a purely systematic method. The arbitrary symbols with which Fraunhofer designated his lines are nowadays hardly more in use, but rather we have had to make up our minds to designate each line by its series relationships. For example, the D-line of Na is represented by $1s - 2p$ (cf. Chap. VI). Corresponding to this we must say in the Röntgen region, not $K\alpha, L\beta, \dots$ but $L_1 \rightarrow K, M_2 \rightarrow L_2, \dots$ or $K - L_1, L_2 - M_2, \dots$. These formulæ, consisting of two terms, so to speak, are very little more cumbersome than the conventional ones and are yet free from all arbitrariness. They certainly take for granted that we have succeeded finally in interpreting the lines. Till this is attained we shall have to help ourselves out, for experimental purposes, with Siegbahn's nomenclature, or, for theoretical considerations, with our nomenclature of the Moseley type.

§ 7. Excitation and Absorption Limits. Regularities in the Absorption Coefficient

In next passing from the line-spectrum of X-rays to the *continuous spectrum*, we have once again to emphasise the fundamental fact that the latter has a sharp limit or edge on the side of short-waves or high frequencies, a fact for which classical electrodynamics could find no explanation and which invokes the aid of the quantum theory. This limit, expressed in wave-lengths by λ_{min} , and in frequencies by ν_{max} , is determined by the voltage V of the Röntgen tube, being independent of the material of the anti-cathode, according to Einstein's law (cf. p. 41):

$$eV = h\nu_{max} = \frac{hc}{\lambda_{min}} \quad \dots \quad (1)$$

If we fix our attention on a definite ν , then, as the voltage is made to pass through a series of increasing values there is a value V_{min} at which this ν appears for the first time although only with vanishing intensity; ν forms the short-wave limit corresponding to this V_{min} . As V increases beyond this value, the intensity with which our ν is represented in the spectrum increases,—indeed, linearly. Hence if we observe the intensity in a small region of wave-lengths, when the rays have been separated spectrally (this measurement is probably best effected by the action of the rays on an ionisation chamber), the **excitation voltage** V_{min} may be sharply determined for each ν ; by dividing the exciting voltage by its corresponding ν , we get at once the factor of proportionality given in (1), and hence also, since e is known, the value of the quantum of action h . Everything seems to favour this as making possible a precision determination of h , provided that the voltage remains constant and is well defined (this is attained by using a great battery of accumulators).

The following, Fig. 57, taken from Duane and Hunt,* shows how

sharply the excitation voltage V_{min} may be determined by this method of observation. The voltages in kilovolts are plotted as the abscissæ, and the deflections of the electrometer, giving the ionisation measured in the spectrometer, are plotted as ordinates. The curves may be called *isochromates* since each one refers to a definite colour, and hence frequency ν . At the foot of each of these ionisation curves, that is directly below

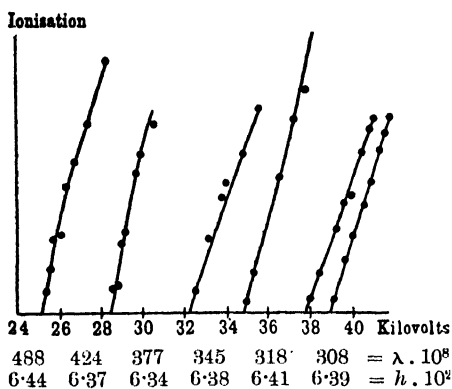

FIG. 57.

the intersections with the x -axis, we have written the corresponding wave-lengths in X-units (10^{-11} cms.) and also the value of the quantum of action, h , calculated from these numbers, and expressed in erg secs., corresponding to the dimensions: energy \times time. More recent researches by D. L. Webster,[†] Webster and Clark,[‡] Blake and Duane,[§] and E. Wagner,^{||} in which the same method was used have considerably reduced the uncertainty in the determination of h ; they lead to the values

$$h = 6.53 \cdot 10^{-27},$$

$$h = 6.55 \cdot 10^{-27}.$$

When we stated above that the limit or edge of the continuous spectrum was found to be independent of the material of the anti-cathode,

* Phys. Rev., **6**, 166 (1915).

† Proc. Nat. Acad., **2**, 90 (1916); Phys. Rev., **7**, 599 (1916).

‡ Proc. Nat. Acad., **3**, 181 (1917).

§ Phys. Rev., **9**, 568; **10**, 93, 624 (1917).

|| Ann. d. Phys., **57**, 401 (1918); Physikal. Zeitschrift, **21**, 621 (1920).

we did not intend this to apply to the increase of intensity at the excitation edge, or, indeed, to the intensity at all. *The intensity*, both the total and the maximum, of the continuous or "impulse" spectrum is observed* to be *proportional to the atomic number of the material of the anti-cathode*, and, for the rest, about *proportional to the square of the excitation voltage V*. So far we have not succeeded in finding a theoretical explanation of these interesting and important laws, that is, to link them up with our present views of atomic structure.

Compared with the continuous spectrum of X-rays, what is now the position of the line-spectrum, the "characteristic" spectrum? Does equation (1) hold for this, too? We already know from § 4 that this question is to be answered in the negative. There we spoke of the *excitation limit* or *edge* of the K-lines, and we use this term to denote the energy that the cathode rays must at least have in order to remove an electron from the K-shell to the periphery of the atom, and thus to prepare it for the emission of the K-series. In Fig. 48, this excitation limit was represented for the K-series (K-limit) by an energy-level that is higher than the energy-levels of K_α , K_β , or even K_γ . It is equal to the difference of level between the zero-level of the periphery of the atom and the K-level. If, in accordance with the $h\nu$ -law, we ascribe to it a frequency ν_K , then the latter satisfies the inequality:

$$\nu_K > \nu_\gamma > \nu_\beta > \nu_\alpha \quad . \quad . \quad . \quad . \quad . \quad (2)$$

The *excitation limit* measured in this way as a frequency is thus the *series limit*, to which the K-lines tend and at which they accumulate (cf. the dotted line in Fig. 58 above). This leads us to certain inferences. Suppose that we allow the voltage or V applied to a cathode-ray tube to be increased gradually up to the value $eV_\alpha = h\nu_\alpha$; we ask when the line K_α , characteristic for the material of the anti-cathode of the tube is emitted for the first time. In contradicton to (1) it is not emitted when the voltage is V_α . We allow the voltage to increase still further, to V_β ; again, neither the line K_β nor even K_α is yet emitted. Rather we must increase the voltage to the excitation limit $e = h\nu_K$ or even further. Then the lines K_α , K_β , K_γ , *appear simultaneously*. This was actually confirmed by very careful experiments of Webster (*loc. cit.*). We follow E. Wagner in calling the difference between ν_K and ν_α the **Stokes lag** of the line K_α and thus link up with Barkla's term, "fluorescent radiation," for the characteristic radiation. The Stokes lag of K_β is less than that of K_α , and that of K_γ is vanishingly small. Stokes' Rule of Fluorescence in the visible region is confirmed without exception in the region of X-rays. In the visible region, where conditions are less simple and less fundamental than in the Röntgen region, there occur occasionally apparent exceptions to Stokes' rule (but cf. p. 184).

The circumstances of the excitation of the L-series are still more

* C. T. Ulrey, *Phys. Rev.*, 11, 401 (1918).

interesting. In Fig. 48 we drew the excitation limit for the lines α, γ, \dots of the L-series. In consideration of the necessary subdivision of the L-level into three minor levels L_1, L_2, L_3 we must, to be accurate, designate as the L-limit, the limit intended in Fig. 48. If we again define a frequency ν_{L_1} corresponding to the energy-level L_1 , then this will be the series limit for the lines $\alpha, \gamma, \epsilon, \zeta, \iota$ of the L-series (cf. the preceding section, Table 12), thus

$$\nu_{L_1} > \nu_\zeta > \nu_\gamma > \nu_\epsilon > \nu_\alpha > \nu_\epsilon \quad \dots \quad (3)$$

The second energy-level L_2 lies, as we saw, deeper than the energy-level L_1 ; the lines $\beta, \delta, \eta, \theta, \kappa$ that end in this level are harder than the doublet lines $\alpha, \gamma, \epsilon, \zeta, \iota$ allocated to them. To excite these lines, it is necessary to lift an electron from the level L_2 to the surface of the atom. The frequency ν_{L_2} defined by the $h\nu$ -relation now becomes the series limit of the second set of doublet lines, and we find the inequality to hold :

$$\nu_{L_2} > \nu_\theta > \nu_\delta > \nu_\kappa > \nu_\beta > \nu_\eta.$$

Thus we have a doublet of excitation limits for the L-series. The fact that the distance between these excitation limits $\nu_{L_2} - \nu_{L_1}$ is, as we would expect after what has gone before, equal, in the case of each element, to the doublet $\Delta\nu_L$ studied in the preceding paragraph, will soon be corroborated by the evidence of direct measurements.

Again we infer : to excite the La-line, the cathode-ray energy equivalent to ν_α is not sufficient. Rather, it is necessary to go as far as the voltage given by $eV = h\nu_{L_1}$, when all the lines $\alpha, \gamma, \epsilon, \zeta, \iota$ of the L-series will appear simultaneously, but not yet the lines $\beta, \delta, \eta, \theta, \kappa$. *To excite these, the energy of the cathode rays must again increase till the second excitation limit is reached. In the case of energies that lie between those of the first and second excitation limits, only the softer line of each L-doublet is produced.* Just as in the K-series the excitation limit ν_K coincides perceptibly with the hardest K-line γ , so in the L-series the limits ν_{L_1} and ν_{L_2} coincide perceptibly with the lines ζ and θ of the hardest doublets, as is shown graphically in the lower part of Fig. 58.

But there is yet a third energy-level L_3 , below L_2 , at which the lines $\phi\phi', \chi\chi', \psi$ end. These lines do not at once appear when the second excitation limit is passed. The voltage V has again to be increased to a *third excitation limit*, given by the equation $eV = h\nu_{L_3}$. It is only then that the L-series is completely formed. And ν_{L_3} almost coincides with the line $L_3\phi$, and we get

$$\nu_{L_3} > \nu_\psi > \nu_\chi > \nu_{\chi'} > \nu_\phi > \nu_{\phi'}.$$

Exact foundations for all these assertions are given by extremely careful measurements carried out by Webster and Clark *, Webster †, and Hoyt ‡

* D. L. Webster and H. Clark, Proc. Nat. Acad., **3**, 181 (1917).

† D. L. Webster, *ibid.*, **6**, 26 (1920).

‡ F. C. Hoyt, *ibid.*, p. 639.

for Pt and W. In the case of W, the three excitation limits, calculated from the frequencies of the lines $\zeta\theta$ and ψ , are :

L ₁ -limit	.	.	.	V = 10.2 kilovolts
L ₂ -limit	.	.	.	V = 11.6 ,,
L ₃ -limit	.	.	.	V = 12.0 ,,

By adjusting the voltage to values in the vicinity of these, the appearance or disappearance of the lines, or their change of intensity could be observed, partly by photographic means, and partly by the ionisation method. According to Hoyt, the following lines are certainly to be allocated to the three limits thus :

L ₁ -limit	.	.	.	$\epsilon\epsilon'\alpha\gamma\zeta\iota$
L ₂ -limit	.	.	.	$\eta\beta\delta$
L ₃ -limit	.	.	.	$\phi'\phi\psi$

in full agreement with the scheme of the preceding section. In the case of χ , χ' , and κ the final allocation is left open. A comparison of their photographic intensities at 12.0 and 12.5 kilovolts seems to favour their inclusion at present in L₃. According to our scheme, χ and χ' should actually belong to L₃, but κ which forms an L-doublet with ι , must be added to L₂. For the same reason, we must count the line θ as belonging to L₂; in the case of W, it was too weak to be observed by Hoyt; in that of Pt it is just exactly covered by χ' . Of course, experiments of this kind are the surest means of arriving at an unambiguous conclusion about the significance of the individual lines.

Earlier, the author, arguing from the supposed existence of an "Λ-doublet" (cf. p. 171), had assumed that, besides the limits L₁ and L₂, there were *two* further limits Λ₁ and Λ₂ in the L-series, of which Λ₁ was supposed almost to coincide with L₂. This assumption falls to the ground with the "Λ-doublet," and is, in particular, refuted by Hoyt's measurements.

Now what happens to the incident energy E of the cathode rays at the excitation limits? It is used to drive the K- or the L-electron to the periphery of the atom and is therefore *absorbed*. What happens, on the other hand, if we allow primary X-rays to fall on to the same material in place of cathode rays? These too, if sufficiently hard, are able, as we know, to excite the characteristic radiation of the matter of the anti-cathode, in accordance with the general law of equivalence $E = h\nu$. But then they must make available for the expulsion of the K- or the L-electron, the same amount of energy E as that furnished in the excitation by cathode rays. The energy of the primary X-rays becomes reduced by this amount when it passes through matter, in which it excites secondary radiation.

That is : the excitation limits become marked in the continuous X-ray spectrum as absorption limits.

In Fig. 58 this is suggested by the continuous tinted bands which are added to the corresponding line-spectra. For example, let us consider the excitation limit ν_K of the K-series. Let the primary Röntgen radiation be that of a tube of about 40 kilovolts tension, that is, it is to have a continuous spectrum which is to extend to wave-lengths of 300 X-units (cf. Fig. 57). Let the matter receiving the radiation be a silver leaf. In the case of Ag (cf. Table 21), the excitation voltage of the K-series is at the wave-length $\lambda_K = 485$ X-units. The softer portions of the incident spectrally resolved continuous spectrum $\lambda > \lambda_K$ are only slightly weakened as they undergo only a general absorption, which, moreover, decreases as the hardness increases. At $\lambda = \lambda_K$ a strong selective absorption suddenly occurs. This persists also for $\lambda < \lambda_K$ up to the limit of the continuous spectrum; it gradually becomes less, corresponding to the uniform decrease of the absorptive power with the increase of hardness.

Fig. 58 exhibits these conditions as they appear on a photographic plate placed directly behind the Ag-leaf.* At the left half of the upper

band, for $\lambda > \lambda_K$, the absorption is weak, that is the darkening of the plate is intense, and indeed the more intense the longer the wave-length, that is, it increases towards the left. At $\lambda = \lambda_K$, the selective absorption of the silver in the leaf comes into action. On the right side of the band the photographic plate is thus strongly screened

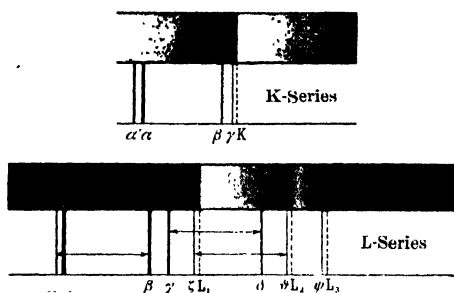

FIG. 58.

by the Ag-leaf. We have at first a region of little darkening and then, as the hardness of the rays increases, a slow increase of the darkening, corresponding to a slow increase in the transparency of the Ag-leaf.

Similar results are found for the L-series. Let the matter through which the radiation is transmitted be, for example, a gold leaf. In the case of Au the three L_1 -absorption or excitation limits L_1, L_2, L_3 are at $\lambda_{L_1} = 1038$, $\lambda_{L_2} = 899$, $\lambda_{L_3} = 861$ X-units (cf. Table 22). Let the radiating X-ray tube emit softer radiations than before, so that it may furnish the region of wave-lengths under consideration with sufficient intensity. For $\lambda > \lambda_{L_1}$ the absorption is uniformly weak; at $\lambda = \lambda_{L_1}$ a strong band of absorption asserts itself; at $\lambda = \lambda_{L_2}$ a second somewhat less intense one appears (corresponding to the smaller intensity of the second lines of the L-doublets in comparison with that of the first); and at $\lambda = \lambda_{L_3}$ a third band appears, which is only weakly represented.

* We here disregard altogether the specific action of silver in the photographic layer, which partly reverses the action of the absorbing silver leaf. This action is illustrated in Fig 59.

Accordingly, a photographic plate which is placed behind the Au-leaf and of which the darkening is shown in Fig. 58 (lower half), exhibits intense darkening to the left of the first limit L_1 ; immediately to the right of this it appears very bright, on account of the selective absorption in the Au-leaf. The darkening increases slowly towards the light till it decreases suddenly at the second limit L_2 , though less suddenly than at the limit L_1 ; at the third limit L_3 a third weak brightening follows. With increasing hardness the darkening beyond L_3 increases continuously.

Concerning Fig. 58, we have yet to remark that, towards the left in the upper part of the figure, the L-absorption limits, towards the right in the lower part of the figure the K-absorption limit, may be imagined to be added, but at a considerable distance away. In the case of Ag the L-limits are so soft that they have escaped observation so far; in the case of Au the K-limit is known, but it would lie quite outside our figure.

After the schematic Fig. 58, we consider in Fig. 59 a spectrum, that was photographed by E. Wagner and J. Brentano, of a tungsten anti-cathode; in the lower part no absorbing layer was interposed, whereas in the upper part the radiation had been made to pass through an

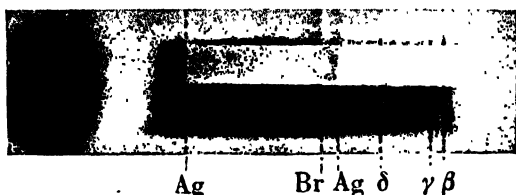

FIG. 59.

aluminium plate 1.4 mm. thick. The big spot on the left is the over-exposed point of intersection of the primary radiation with the photographic plate. A revolving crystal has spread out the wave-lengths in increasing order towards the right, that is, in the opposite direction to that in the schematic Fig. 58. At the right end of the lower part of the figure we see the comparatively soft L-lines of the tungsten anti-cathode marked out with extraordinary clearness on the weakly tinted background, which represents the continuous spectrum of the anti-cathode. The lines α and α' were too distant to be taken on the plate. The photographed lines are successively, counted from right to left, ϕ' , β , ϕ , γ , δ , χ' , χ , ψ ; the three most intense lines β , γ and δ have been made recognisable as such in the margin. In the upper part of the figure the softer L-lines and, for the greater part, also the continuous background has been extinguished by absorption in the aluminium sheet (this is the general, not the selective absorption; the selective K-absorption of Al occurs at much softer wave-lengths and would be obtainable only in the vacuum spectrograph, and still more so the L-absorption edges). If we follow the continuous spectrum towards

the left, in the lower part of the figure, we come across several striking sharply defined absorption edges that here (namely, in the scale of wave-lengths) extend towards the left with decreasing darkening. What do these absorption edges in the lower part of the figure denote, in view of the fact that no absorbing medium intervenes? It has been ascertained from indisputable and unambiguous experiments that they are due to the *photographic silver bromide layer*. The intense band on the left is the K-absorption edge of Ag and it is repeated in the weak band furthest to the right; the extended band between these is the K-absorption band of Br. Corresponding to its position in the natural system (Br, $Z = 35$; Ag, $Z = 47$) the Br-band is softer than the Ag-band. The former is entirely extinguished by the Al-sheet whereas the latter is *not* absorbed either in the second order or in the first. Of course, actually, the Ag-band reflected in the second order has the same wave-length as that in the first order. This explains the circumstance, which at first sight seems paradoxical, that the Br-band is weakened more in its passage through the absorbing Al than the Ag-band of the second order, which, according to its position in the figure, seems softer, but which is in reality much harder. To conclude the description of this instructive figure we have now only to mention that the photographic darkening is dependent on the quantity of the absorbed energy. That is why the plate becomes dark, particularly where the wave-lengths absorbed selectively by the Ag or the Br meets it. The AgBr layer acts simultaneously as an absorber and as an indication of the absorbed energy, and its increased absorption is indicated by increased darkening. A bolometric or an ionisation measurement of the radiation transmitted by the AgBr layer would, on the other hand, indicate increased absorption by exhibiting a lessening of the energy.

We now give figures of the absorption limits. The ν/R values have been placed alongside of the λ -values, and in the case of the L-series the values of the $\frac{\Delta\nu}{R}$ doublets are also shown. Table 21 gives the K-edges or limits, Table 22 the L-edges.

A comparison of Tables 21 and 10 confirms that the K-limits lie hard by the line $K\gamma$, and, indeed, in accordance with Stokes' law they are displaced a little towards the direction of shorter wave-lengths,* by about $\frac{1}{2}$ per cent, as Duane and Stenström have proved for W by means of precision measurements.† The same remark follows from a comparison of Tables 22 and 13, with regard to the L-edges, and the lines $L\zeta$, $L\theta$,

*The opinion held by H. Fricke, *Phys. Rev.*, **16**, 202 (1920), that the K-limit of Mg is softer than the line $K\beta$ ($K\gamma$ was not observed in this case) is contradicted by the $K\beta$ measurement of Hjalmar (given in our Table 10). In the L-series, Duane and Patterson, *Proc. Nat. Acad.*, **6**, 508 (1920), have felt themselves obliged to register an infringement of Stokes' law in the case of tungsten. For the lines which we have called $\zeta\theta$ (cf. Table 13) this is, however, not so.

† *Proc. Nat. Acad.*, **6**, 477 (1920).

and $L\psi$. But, further, a comparison with Table 15 shows that *the absorption doublets of the L-series coincide, within the limits of error, with the emission doublets.* The significance of this fact in the atomic model becomes particularly clear in the light of Fig. 55: the absorption doublet is given as the difference in the energy-levels by the energy-step between the L_1 - and the L_2 -level, in the same way as the emission doublet is given as the depression in passing to the new energy-level.

TABLE 21
Absorption Limits of the K-series

Element	λ in X-units	ν/R	Element	λ in X-units	ν/R
12 Mg	9511.2	95.81	45 Rh	533.0	1709.7
13 Al	7947.0	114.67	46 Pd	507.5	1795.6
15 P	5758.0	158.26	47 Ag	485.0	1878.9
16 S	5012.3	181.81	48 Cd	463.2	1967.3
17 Cl	4384.4	207.84	49 In	443.4	2055.2
18 A	3865.7	235.73	50 Sn	424.2	2148.2
19 K	3434.5	265.33	51 Sb	406.5	2241.7
20 Ca	3063.3	297.48	52 Te	389.6	2339.0
21 Sc	2751.7	331.17	53 J	373.7	2438.5
22 Ti	2493.7	365.43	55 Cs	344.4	2646.0
23 V	2265.3	402.27	56 Ba	330.7	2755.6
24 Cr	2067.5	441.14	57 La	318.8	2858.4
25 Mn	1889.2	482.36	58 Ce	306.8	2970.2
26 Fe	1739.6	523.84	59 Pr	294.6	3093
27 Co	1601.8	568.90	60 Nd	283.5	3214
28 Ni	1489.0	612.00	62 Sm	263.6	3457
29 Cu	1378.5	661.06	63 Eu	254.3	3584
30 Zn	1296.3	702.98	64 Gd	245.6	3710
31 Ga	1190.2	765.64	66 Ds	229.4	3972
32 Ge	1114.6	817.57	67 Ho	221.4	4116
33 As	1043.5	873.28	74 W	178.06	5117.8
34 Se	979.0	930.82	78 Pt	158.1	5764
35 Br	917.9	992.78	79 Au	153.4	5941
37 Rb	814.3	1119.1	80 Hg	149.1	6112
38 Sr	769.6	1184.1	81 Tl	144.8	6293
39 Y	725.5	1256.1	82 Pb	141.0	6463
40 Zr	687.2	1326.1	83 Bi	137.2	6642
41 Nb	650.3	1401.3	90 Th	113.1	8057
42 Mo	618.0	1474.5	92 U	107.5	8477
44 Ru	558.4	1631.9			

Observers: Fricke, *Phys. Rev.*, **16**, 202 (1920) (Elements 12 Mg to 24 Cr). Duane and Kang-Fu-Hu, *ibid.*, **14**, 516 (1919) (Elements 25 Mn to 58 Co). Siegbahn and Jönsson, *Phys. Zeitschr.*, **20**, 251 (1919) (Elements 59 Pr to 67 Ho). Duane and Stenström, *Proc. Nat. Acad.*, **6**, 477 (1920) (74 W). Duane, Fricke and Stenstrom, *ibid.*, **6**, 607 (1920) (Elements 78 Pt to 92 U).

It is to be regarded as an outstanding achievement of science that also the M-absorption limits have been fixed completely at least in the case of the heaviest elements. In the cases of U and Th, Stenström found three, and Coster five different limits, that is just as many as we found it necessary to assume in the scheme of L-lines of emission to explain their existence. The three softest limits were observed by Coster

TABLE 22
Absorption Limits of the L-series

Element	Wave-lengths			Values of ν/R			$\Delta\nu$ R
	L_1	L_2	L_3	L_1	L_2	L_3	
55 Cs	2459	2299	2157	370.6	396.4	422.5	25.8
56 Ba	2348	2194	2063	388.1	415.3	441.7	27.2
57 La	2250	2098	1971	405.0	434.4	462.3	29.4
58 Ce	2158	2007	1887	422.3	454.0	482.9	31.7
59 Pr	2071	1922	1808	440.0	474.1	501.0	34.1
60 Nd	1992	1842	1736	457.5	494.7	524.9	37.2
74 W	1213.6	1072.6	1024	750.88	849.59	889.9	98.71
78 Pt	1070.5	932.1	888.5	851.26	977.65	1025.6	126.39
79 Au	1038.3	899.3	860.6	877.65	1013.2	1058.9	135.5
80 Hg	1006.7	870.0	833.5	905.20	1047.4	1093.3	142.2
81 Tl	977.6	841.5	805.5	932.15	1032.9	1131.3	150.7
82 Pb	949.7	813.3	780.3	959.53	1120.5	1167.8	160.9
83 Bi	921.6	787.2	753.2	988.79	1157.6	1209.9	168.8
90 Th	759.6	628.6	604.4	1199.7	1449.7	1507.7	250.0
92 U	721.4	591.8	568.5	1263.2	1539.8	1602.9	276.6

Observers: G. Hertz, *Zeitschr. f. Phys.*, **3**, 19 (1920) ($Z = 55$ to 60). W. Duane and R. A. Patterson, *Proc. Nat. Acad.*, **6**, 509 (1920) ($Z = 74$ to 92).

for Bi, too. The orderly sequence (cf. also Chap. VIII, § 5) in the number of limits or energy-steps, namely, K_1 , L_3 , M_5 , N_7 , is worthy of notice. The last number is used as a theoretical postulate for founding Table 12, but for the present there seems little chance of verifying it experimentally. As a matter of fact, even in the case of the absorption limits of the M-series the experimental difficulties are extraordinarily great. Not only is it necessary to use a vacuum spectrograph, but it is also necessary to prepare the absorbing metallic salts in extremely small quantities, for example, by soaking tissue paper in them. The result of the measurements is given by Table 23, which, following Coster, we express in wave numbers ν/R .

TABLE 23

	M_1	M_2	M_3	M_4	M_5	} ν/R -values
83 Bi . .	191.96	199.44	233.9	—	—	
90 Th . .	244.90	256.55	297.99	354.4	381.6	
92 U . .	261.03	273.99	317.18	382.1	408.9	

In placing the excitation and the absorption limits after the emission lines we have simply followed the course of the historical development. From the strictly systematic standpoint, however, we should have reversed the order, as is actually and rightly done in a report by

W. Duane on Röntgen spectra.* The behaviour of the atom as regards energy expresses itself most clearly and most simply in the existence of the absorption limits. They represent directly the portions of energy, by the manifold combinations of which alone the emission lines are able to be produced. Compared with the former, the latter are complicated expressions of the energetic structure of the atom.

The relation between absorption limits and emission lines in the X-ray region is the same as that between the "terms" (cf. Chap. VI, § 1) and the wave-numbers of the lines in the visible region. *The object of spectroscopy is to determine the atomic states and their energy values.* These are represented directly by the **series terms**. The observation of spectral lines is merely a means of arriving at the terms. *Only when the spectral lines have been developed in series, and have been resolved into terms, may the object of spectroscopy be said to have been attained.*

The laws of selection according to which the energy-steps of the atom conspire together to produce emission lines of Röntgen spectra will not be given before Chapter VIII. More involved theoretical steps are necessary before they can be made clear. Only then, too, shall we be in a position to prove the correctness of our table of the methods of origin by which the lines of the K-, L-, and M-series are produced. Each datum of the table implies a quite definite numerical statement about a relationship between the energy-quanta or, what amounts to the same, the wave-numbers of an emission line and of two absorption limits. For example, when we denote the origin of $L\alpha$ by the symbol $M_1 \rightarrow L_1$, we assert that the following equation holds exactly between the wave-number ν of $L\alpha$ and the wave-numbers ν_{L_1} , ν_{M_1} of the limits L_1 , M_1 :

$$\nu = \nu_{L_1} - \nu_{M_1} \quad \cdot \quad \cdot \quad \cdot \quad \cdot \quad \cdot \quad \cdot \quad \cdot \quad \cdot \quad (2)$$

for which we may more conveniently write

$$\nu = L_1 - M_1 \quad \cdot \quad \cdot \quad \cdot \quad \cdot \quad \cdot \quad \cdot \quad \cdot \quad \cdot \quad (3)$$

It is to be remarked that, in the case of the K-series in Table 9, the origins of $K\beta$ and $K\gamma$ were indicated only generally by the statements $M \rightarrow K$, $N \rightarrow K$, and no further details were given as to which M- or N-level here comes into consideration. Since rather subtle questions arise in dealing with the origin of $K\beta$ in particular, which we shall not be able to treat before the last chapter (under the heading "Defective Combinations"), we shall wait till then before adding the details that are still wanting for the exact definition of $K\beta$ and $K\alpha$.

When the origin of all the lines is known, we shall be able to replace the tabulation of the lines by a mere tabulation of the limits together with the rules of combination that correspond to the origin of the line in question. Thus, in principle, the tables of this paragraph may replace those of the preceding paragraph. Analogous conditions hold in the

* Bulletin of the National Research Council, 1, 383 (1920).

visible region. Whereas earlier reference books used to contain detailed tables of the wave-lengths, but could add no resolution into terms, the tables of, for example, Dunz (cf. Chap. IV, § 2) furnish, in addition to the wave-lengths, the values of the **terms** which are of most interest to us, and which are of the greatest physical importance. In future, indeed, it will be sufficient to know the terms alone, as long as the mode of origin of the lines in question, that is their resolution into terms, is firmly established. We actually put this point of view into practice for the X-rays in Chapter VIII, § 6, under the heading "Table of Term Values."

Hitherto we have dealt only with the *position* of the absorption limits. Concerning the *amount of the absorption* we mentioned merely its general decrease as the wave-length decreased and its sudden increase in passing the absorption edge. The amount of the absorption is measured numerically by the **absorption coefficient** μ . This is defined by the statement that for homogeneous radiation the relative decrease of intensity in the passage through a layer of depth d is $e^{-\mu d}$. From the absorption coefficient μ , we pass on to the *true absorption coefficient* $\bar{\mu}$ in which the loss due to the coefficient of scattering s (cf. Chap. I, p. 31) has been subtracted; and from this again, if we divide it by the number of atoms per cubic centimeter, to the *true absorption coefficient per atom*, which we shall call $\bar{\mu}_{at}$. According to calculations by R. Glocker,* the way in which the latter depends on the wave-length λ of the absorbed radiation and on the atomic number of the absorbing element is represented for the neighbourhood of the K-absorption limit by the formula (λ being measured in cms.):

$$\bar{\mu}_{at} = \begin{cases} 22.8 \cdot 10^{-6} Z^{4.28} \cdot \lambda^{2.8} & \text{for } \lambda > \lambda_K \\ 1120 \cdot 10^{-6} Z^{3.72} \cdot \lambda^{2.8} & \text{for } \lambda < \lambda_K \end{cases} \quad (4)$$

We arrive at this formula if we plot the logarithms of the measured values of the absorption coefficients as ordinates, and the logarithms of the wave-lengths or the atomic numbers, respectively, as abscissae. The points so obtained lie along segments of straight lines, from the position of which the factors 22.8 and 1120, and from the inclinations of which the exponents 2.8, 4.28, and 3.72 are determined. The uncertainty of the exponent 2.8 of λ makes it fluctuate between 2.5 and 3.0,† according to experiment. The very unconvincing fractional form of the exponent shows that we are dealing only with an empirical formula and that the proper theory of the process of absorption is still wanting.

In this way we get for the dependence of $\log \mu$ on $\log \lambda$ the characteristic picture of Fig. 60. Suppose we are dealing, for example, with Ag, at first in the vicinity of the K-absorption edge, $\lambda_K = 485$ X-units. If

* Physikal. Zeitschr., **19**, 66 (1918); the formula given above for the atomic absorption coefficient was kindly furnished by Mr. Glocker for the purposes of this account.

† For extremely hard wave-lengths far below the absorption limit, measurements by G. W. Hewlett, Phys. Rev., **17**, 284 (1921), indicate that $\bar{\mu}$ is proportional to λ^2 . Cf. in this connexion Note 2 at the end of the book.

we start from the less hard rays ($\lambda > \lambda_K$, at the right end of the continuous line in the figure), $\log \mu$ decreases uniformly as $\log \lambda$ decreases, as far as $\lambda = \lambda_K$. At the latter point, on account of the excitation of the characteristic radiation of Ag, increased absorption begins; the absorption coefficient suddenly jumps up, and, indeed, to a value seven times as great as that before the jump; to this there corresponds in the logarithmic representation a jump of the amount $\log 7 = 0.84$. After the jump the uniform decrease of the absorption recommences as the absorbed radiation increases in hardness; the logarithmic value of the decrease as before

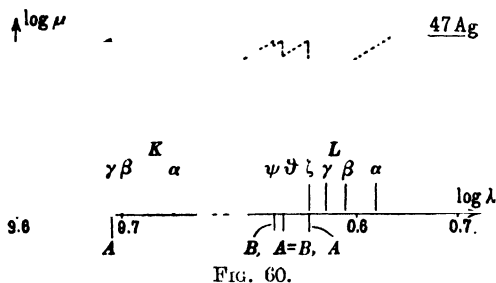

the jump, being again determined by the exponent 2.8 of λ in equation (2). If, on the other hand, we go towards the right into the dotted region (which is not corroborated by measurements in the case of Ag), we arrive at the L-absorption limits. The course is here, if we judge for instance from the example of Au, similar to that for the K-absorption limit: there are sudden jumps, the graph having a parallel course before and after the jump. In the figure three such jumps, of decreasing intensity, have been inserted, corresponding to the three absorption limits L_1, L_2, L_3 .

Concerning the rise of the absorption at the limit in question, it is not quite sharp and sudden as was previously believed and as it appears in Fig. 60. Rather, the limit has a certain structure. Stenström showed this for the M-limits, G. Hertz for the L-limits, and Fricke for the K-limits of the lightest elements. Fig. 61 shows the K-limit of sulphur, according to H. Fricke,* as a photometric record of the darkening of the plate. Great values of the ordinates denote good transmission, that is,

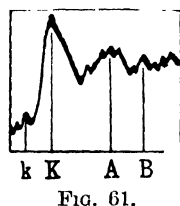

little darkening of the plate measured photometrically and corresponding strong absorption in the absorption film placed in front of the plate. The photograph for the case of sulphur shows a precipitous but nevertheless steady rise of the absorption between k and K . The distance kK amounts to about 5 X-units and is a measure, so to speak, of the breadth of the K-edge. But the two absorption maxima behind K , called A and B in the figure, are still more remarkable. (The small zig-zags are due

* Phys. Rev., 16, 202 (1920).

to the granules of the photographic plate.) In the photographs the intervening minima appear as comparatively sharp lines of brightness.

Kossel* accounts for the successive maxima as follows. The main limit K corresponds to the energy that is necessary to transport an electron from the K-shell to the periphery of the atom, and the succeeding maxima A and B correspond to the transitions of a "K-electron" to certain virtual orbits, characterised by certain quantum conditions, which lie outside the atom. The amounts of energy necessary for this are, of course, greater than that corresponding to the true K-limit. The maxima A, B, . . . therefore lie on the side of greater vibration numbers. On Kossel's view it follows that the intervals separating these maxima from each other and from K, when measured in wave-numbers, must be of the order of magnitude of the Rydberg constant R, and this is confirmed by the figure. Further, it follows that the phenomenon of a band-structure is accessible to observation only in the case of very soft bands, that is, for the K-bands, only in the case of the lightest elements. In the absorption edges in the harder region, the successive maxima, when measured in wave-lengths, crowd together.

This leads us to a fundamental question. Why is it that the visible spectral lines may be observed both in emission and in absorption, but the Röntgen rays occur only as emission lines? The ground of this is, according to Kossel again, to be sought in the difference between the inner regions of the atom and the outer regions. In the *interior* the shells (the possible "quantum orbits") are occupied by electrons and an electron that is ejected out of the interior finds no vacant orbit and must therefore escape to, at least, the periphery of the atom. In the *outer regions* of the atom, however, the "quantum paths" of the electrons are free; they are virtual not real electronic orbits. When excited, the electron that is removed out of its natural orbit can pass over into any of these virtual orbits. Each such transition corresponds to a definite acquisition of energy and hence, according to the $h\nu$ -law, to the absorption of a definite spectral line. In the Röntgen region, however, absorption lines occur only as secondary phenomena accompanying the absorption edges in transitions that stretch beyond the periphery of the atom into the outer region of the atom unoccupied by electrons.

Whereas, in Fig. 60, Z was kept fixed and λ was varied, the dependence of the absorption coefficient on Z is obtained from a logarithmic graphical representation in which λ is kept fixed and Z is varied. Here too the course is along straight lines. According to investigations by Bragg and Peirce† the steepness of the descent is measured by the exponent 4 of Z , and whereas, according to calculations of Glocker, the exponent is 4.28 or 3.72 according as $\lambda > \lambda_K$ or $\lambda < \lambda_K$ respectively. (It is interesting to note that the two latter numbers differ by the same amount

* Zeitschr. f. Phys., 1, 124 (1920).

† Phil. Mag., 28, 608 (1914).

from 4.) Glocker's determination, which is founded on more comprehensive material than that of Bragg and Peirce, is without doubt the safer of the two. The fact that the exponents of Z cannot be the same for $\lambda > \lambda_k$ as for $\lambda < \lambda_k$ already follows from the circumstance that the absorption jump, measured by the ratio of the $\bar{\mu}$'s before and after the jump diminishes systematically as Z increases, whereas if the exponents were equal, as given by Bragg and Peirce, it would be independent of Z . It is by no means necessary that the absorbing substance be present in the form of an element. The absorption of Röntgen rays is, like their emission (cf. p. 148), an additive property of the atoms composing the substance.

Finally, we shall make a little digression into the region of *medical Röntgen photographs*. These are, as we know, whether received on a fluorescent screen or on the photographic plate, *shadow pictures*. They are thus concerned only with the transmissive or the absorptive power of the object through which the rays pass. The human body is essentially composed of the elements H, C, N, O, P, Ca (for which $Z = 1, 6, 7, 8, 15, 20$). Now the atomic absorption increases, as we saw, approximately in proportion to the fourth power of the atomic number, and the absorption of a compound, of a mixture or of an aqueous solution is composed of the additive absorptions of its constituents. Thus to know the absorption of bone-substance $\text{Ca}_3(\text{PO}_4)_2$, we have only to superpose the absorptions of Ca, P, and O, whereby each is to be counted the number of times it occurs in the formula (thus, 3, 2, and 8), and to find the relative absorption of the bones with respect to the surrounding tissues, we have to compare them with the absorptions of H_2O , which is easily the preponderant constituent of the tissues. In this way we get:

$$3 \cdot \frac{20^4}{2 \cdot 8^4} + \frac{2 \cdot 15^4}{2 \cdot 8^4} + 8 \cdot \frac{8^4}{2 \cdot 8^4} = 3 \left(\frac{5}{2}\right)^4 + 2 \left(\frac{15}{8}\right)^4 + 8.$$

As we see from this the amount for Ca considerably outweighs even that for P; the fluorescent screen counts, so to speak, only the Ca-atoms. But if a lead bullet (Pb, $Z = 82$) is lodged in the bone, its absorption exceeds that of the bone to an extraordinary degree. The excellent contrast effect produced by a solution of bismuth that has been introduced into the stomach or the intestine is due to this; for its atomic number is 83. The concentration of the bismuth solution need not even be high; on account of the ten times higher atomic number of bismuth compared with oxygen, a Bi-atom acts about as strongly as 10,000 O-atoms and 1 grm. of Bi acts about as strongly as 1 kilogramm. of water. The same explanation holds for the surprisingly strong absorptive action of iodine preparations that are photographed, for example, as iodoform in the bandages; for iodine has the atomic number 53.

But the dependence of the absorption on the wave-length and its jump at the absorption edge also comes into account for the medical use of

Röntgen rays. For it is on this fact that one of the commonest hardness-gauges, that of Wehnelt and the attached Wehnelt scale is founded (or Benoist's hardness-gauge, which is based on the same principle). Its construction is familiar: an aluminium wedge is placed alongside a silver plate of uniform thickness. We read off that position of the aluminium wedge at which it absorbs just as strongly as the silver plate, so that equal brightness is caused in the fluorescent screen. Whereas Al absorbs all rays regularly—for the K-edge of Al has such a soft wave-length that it does not come into question practically—the Ag absorbs the harder rays for which $\lambda < 485$ X-units selectively and absorbs only the softer rays regularly. Therefore, in the transition from soft to harder rays, the point of equal brightness moves along the scale in the direction of the thicker end of the Al-wedge, as then the Ag-absorption begins for a greater part of the mixed rays and so the same thickness of silver becomes equivalent to a greater thickness of the aluminium wedge.

This may suffice to show that in the medical application of X-rays the more refined results of physical research, in particular those concerning the absorption laws, come into account.

CHAPTER IV

THE HYDROGEN SPECTRUM

§ 1. Introduction to the Theory of Quanta. Oscillators and Rotators

IF we wish to penetrate further into the nature of the theory of quanta, we must not restrict ourselves to the special case of vibrational energy, which we treated alone in Chapter I, § 6. This case takes precedence historically; it led Planck to formulate from heat radiation a definition of his **quantum of action** h . The simple oscillator was used by Planck in a certain sense as a theoretical resonator to heat radiation; by means of it he developed his hypothesis of energy-quanta (see p. 37). This hypothesis is the foundation of the photo-electric law of Einstein and also of its extension as Bohr's hypothesis concerning emitted and absorbed energy.

Adopting a more general standpoint we shall consider instead of a special Planck oscillator *any arbitrary mechanical system whatsoever*, or, for the present, a little more specially, *any arbitrary moving point-mass*, whereby it matters little whether we assume it to be charged (an electron) or not.

We find it expedient to begin by enunciating the form that Newton gave the mechanical laws in his *Principia*, in particular his *Definitio II* and *Lex II* (*Definitio I* defines the conception of mass; *Lex I* is the law of inertia).

Definitio II: *Quantitas motus est mensura ejusdem, orta ex velocitate et quantitate materiae conjunctim.*

"The momentum (amount of motion) is the product of the mass and the velocity."

Lex II: *Mutationem motus proportionalem esse vi motrici impressae et fieri secundum lineam rectam, qua vis illa imprimitur.*

"The change in the momentum (amount of motion) is proportional to the impressed force and takes place in the direction in which that force acts."

In place of amount of motion we say **momentum** or **impulse**; we denote the impulse by p , and hence by *Definitio II* we have:

$$p = mv \quad . \quad . \quad . \quad . \quad . \quad . \quad (1)$$

As usual, we designate the position of the point by rectilinear co-ordinates x , y , z . For the sake of generalisation later, we shall, however, use,

instead of different letters, different suffixes attached to the same letter thus: $q_1 = x$, $q_2 = y$, $q_3 = z$. The velocity is then given in magnitude and direction by

$$\dot{q}_k \left(\text{where } \dot{q}_1 = \dot{x} = \frac{dx}{dt}, \dot{q}_2 = \dot{y}, \text{ etc.} \right)$$

and if p_1, p_2, p_3 are the corresponding components of the momentum or impulse then, by (1),

$$p_k = m\dot{q}_k \quad \dots \quad (2)$$

The fact that the *dynamical* triplet of impulse co-ordinates occurs conjointly with the *geometrical* triplet of the co-ordinates of position is of great importance to us. Furthermore, the above formulation of the law of motion, Newton's *Lex II*, is of particular importance to us, especially with regard to the foundation of the theory of relativity (cf. Chap. VIII). It is wrong to speak of Newton's "Law of Acceleration." *It is not the kinematic quantity acceleration* but the dynamic quantity change of momentum that is regulated by this law.* In this sense we write down *Lex II* for each co-ordinate direction ($k = 1, 2, 3$) separately:

$$\dot{p}_k = \mathbf{K}_k = - \frac{\partial E_{pot}}{\partial q_k} \quad \dots \quad (3)$$

In (3) we assume that the force \mathbf{K} is derivable from a potential energy E_{pot} (function of q_k). The kinetic energy is:

$$E_{kin} = \frac{m}{2} (\dot{q}_1^2 + \dot{q}_2^2 + \dot{q}_3^2) = \frac{p_1^2}{2m} + \frac{p_2^2}{2m} + \frac{p_3^2}{2m}$$

by (2). We call the total energy, considered as a function of q_k and p_k , **Hamilton's function** H . We have:

$$H(q, p) = E_{kin} + E_{pot}, \quad \frac{\partial H}{\partial q_k} = \frac{\partial E_{pot}}{\partial q_k}, \quad \frac{\partial H}{\partial p_k} = \frac{\partial E_{kin}}{\partial p_k} = \frac{p_k}{m}$$

Consequently we may write the fundamental equations (2) and (3) in the form:

$$\frac{dq_k}{dt} = \frac{\partial H}{\partial p_k}, \quad \frac{dp_k}{dt} = - \frac{\partial H}{\partial q_k} \quad \dots \quad (4)$$

This *Hamiltonian* or *canonical* form of the equations of motion is remarkable not only on account of its symmetry but also because it remains preserved if any arbitrary new co-ordinates are introduced (cf. Note 4) and because it holds not only for an individual point-mass but

* Of course, when the mass is constant $\dot{p} = m\dot{q} = \text{mass} \times \text{acceleration}$. But in general the mass is not constant; in the theory of relativity it is not even constant for a single particle of mass; and in ordinary mechanics it is not constant for a rigid body, for then the rôle played by mass is taken over by the moment of inertia, and this varies during motion. In these cases Newton's assertion about change of momentum remains valid, but not the statement about mass \times acceleration which has wrongly become prevalent.

also for any arbitrary mechanical system. For arbitrary co-ordinates and systems* the impulse p is defined by :

$$p_k = \frac{\partial E_{kin}}{\partial \dot{q}_k} \quad \dots \quad (5)$$

in which the kinetic energy is to be regarded as expressed as a function of the q_k 's and the \dot{q}_k 's. For the individual mass-point, (5) clearly becomes identical with (2) if rectangular co-ordinates are used.

The values of the co-ordinates q and p determine the corresponding state or **phase** (in Gibbs' terminology) of the system. To get a vivid picture of the state of motion in terms of the position (q) and the velocity or impulse (p), respectively, we imagine, in the case of an individual point-mass (which has three degrees of freedom), its three position co-ordinates q and its three impulse co-ordinates p drawn as perpendicular co-ordinate axes in a space of six dimensions, so that each point of this space represents a phase of our point-mass. In a system having f degrees of freedom this **phase-space** is of $2f$ dimensions.

Fortunately, we need not frighten off the reader by discussing our problems in multi-dimensional space. We may rather for the present restrict ourselves to systems of one degree of freedom, for which the general phase-space resolves into a single phase-plane. Later, too, when we shall have to consider systems of several degrees of freedom, we shall be able to arrange so that we have only to discuss two-dimensional sections of the phase-space, that is, again, certain simple phase-planes.

We draw q and p as rectangular co-ordinates in the phase-plane of our system. In this plane we construct the *phase-paths* or *orbits*, that is, the sequence of those graph points that correspond to the successive states of motion of the system. Choosing any point as an initial state we may plot the phase-paths and densely cover the whole of the phase-plane. The characteristic feature of the quantum theory, however, is that it selects a discrete family of phase-orbits from the infinite manifold of phase-orbits. To define these selected orbits, we shall first consider the area of the phase-plane included between two arbitrary phase-orbits: we shall call such an area a **phase-area**. We then draw our family of orbits so that the phase-area between two neighbouring orbits is always equal to the quantum of action h . In this way h acquires the significance of the *elementary region* (or element) of the phase-area. We shall regard this significance as constituting the true definition of Planck's quantum of action h . We shall next illustrate these rather abstract ideas by means of two very important special cases, that of the **oscillator** and that of the **rotator**.

We give the name **linear oscillator** to a point-mass m that is bound elastically to its position of rest and that can be moved to either side of

* We shall not discuss here how the definition is to be generalised for the case when the acting forces have no potential.

this central position only in a direction $x = q$ or its reverse, whereby it experiences a restoring force but no damping resistance. The oscillator is the simplest instance of a centre of vibration such as is assumed in Optics in the form of a "quasi-elastically bound electron." We use the more accurate term "harmonic oscillator" if we wish to emphasise that the latter is capable only of a definite characteristic or natural vibration on account of its elastic attachment. Let the vibration number or frequency of the oscillator (number of its free vibrations per unit of time) be ν . The vibration phenomenon is then expressed by :

$$x = q = a \sin 2\pi\nu t \quad . \quad . \quad . \quad (6)$$

In this case the impulse p simply becomes equal to $m\dot{q}$ (according to (2), and in agreement with (5)). Hence

$$p = 2\pi\nu ma \cos 2\pi\nu t \quad . \quad . \quad . \quad (7)$$

By eliminating t from (6) and (7) we get as our phase-orbit an ellipse in the p - q -plane having the equation :

$$\frac{q^2}{a^2} + \frac{p^2}{b^2} = 1 \quad . \quad . \quad . \quad (8)$$

in which the minor axis b is defined by

$$b = 2\pi\nu ma \quad . \quad . \quad . \quad (9)$$

The area of the ellipse is then :

$$ab\pi = 2\pi^2\nu ma^2.$$

We next assert that this same quantity is also equal to $\frac{W}{\nu}$, where W denotes the energy, which remains constant during the vibration. If, for example, we calculate W at the time $t = 0$, the potential energy is zero, and the kinetic energy is

$$\frac{m}{2} a^2 (2\pi\nu)^2 = W \quad . \quad . \quad . \quad (10)$$

and hence, actually,

$$ab\pi = \frac{W}{\nu} \quad . \quad . \quad . \quad (11)$$

By altering W we get in the phase-plane the phase-orbits as a family of similar ellipses since, by (9), the ratio $\frac{b}{a}$ has the constant value $2\pi\nu m$.

We have now to make the selected ellipses of this family succeed one another in such a way that the elliptic zones have each the same area h . Then h is at the same time (see Fig. 62) the area of the first (or innermost) ellipse; the second ellipse has thus the area $2h$, the n^{th} the area nh . If W_n is the energy of the oscillator, when it describes the n^{th} ellipse as its orbit, then according to (11)

$$W_n = nh\nu \quad . \quad . \quad . \quad (12)$$

Whereas in the classical theory all points of the phase-plane are of equal value and represent possible states of the oscillator, the states for which the graph points lie on one of the ellipses of our family are distinguished. They represent the stationary states of the oscillator, that is, such states as the oscillator may pass through without cessation and without loss of energy, in other words, in the case of a charged point-mass, without radiating energy. Equation (12) shows that in these orbits the energy is a whole multiple of the elementary quantum of energy ϵ , that is,

$$\epsilon = h\nu, \quad W_n = n\epsilon \quad . \quad . \quad . \quad (13)$$

We thus arrive at the idea of energy-quanta that we hinted at in the opening paragraph of this section and that we introduced on page 37. When the oscillator retains its stationary state with constant energy, its graph point traverses during one vibration an ellipse of the family in the phase-plane. From time to time, however, the energy of the oscillator changes, and when its graph point jumps over to a smaller ellipse it emits energy; but when its graph point passes over to a larger ellipse it absorbs energy. The emission and absorption occurs in multiples of the energy quantum ϵ .

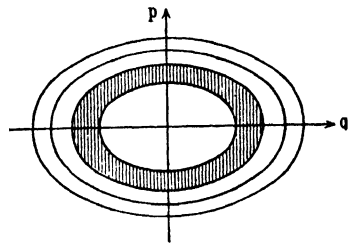

FIG. 62.

Owing to the assumption of discrete phase-orbits and discrete energies, the oscillator may only describe motions of definite amplitude (of maximum displacement) and velocity. For from (6), (10), and (13) the resulting magnitude of these two amplitudes is :

$$q_{max} = \frac{2}{2\pi\nu} \sqrt{\frac{2n\epsilon}{m}}, \quad \dot{q}_{max} = \sqrt{\frac{2n\epsilon}{m}}$$

We have given here the extreme form of the quantum theory, which recognises only discontinuous transitions between the various motions of the oscillator. To obviate this paradoxical idea, Planck later developed a form of the quantum theory in which phase-points in the interior of the elliptical zones may also be regarded as possible states of the oscillator, that is a theory in which the graph point of the oscillator is not exclusively bound to the confines of the elementary regions. When energy is absorbed, the graph point is to displace itself in a continuous manner through the interior of the elementary region and is to jump from one boundary curve to another only when energy is emitted. For our purpose, however, the first form of the quantum theory will be more appropriate. We therefore make the definite assertion (for the oscillator and for every mechanical system of one degree of freedom): *The graph point (of the system) in the phase-plane is restricted to certain "quantised"*

phase-orbits (which characterise certain quanta). Between each orbit and its successor there is an elementary region of area h . The n^{th} of these orbits (if closed) has an area nh . Expressed as a formula this is :

$$\iint dpdq = nh \quad . \quad . \quad . \quad . \quad (14)$$

wherein the integral is to be taken over *the interior of the n^{th} orbit*. If we carry out the integration with respect to p (corresponding to the elementary formula $\int ydx$ for the area of a curve $y = f(x)$), we get

$$\int p dq = nh \quad . \quad . \quad . \quad . \quad (15)$$

This integral is to be taken *along the n^{th} orbit itself*. We shall call the left member of this equation *phase-integral* and denote it by J , i.e.

$$J = \int p dq \quad . \quad . \quad . \quad . \quad (15a)$$

We consider the definitive formulation of the quantum hypothesis to consist in the postulate that **the phase-integral must be a whole multiple of the quantum of action h** . This postulate singles out of *the continuous manifold of all mechanically possible motions a discrete and infinite number of real motions, that is such as are possible according to the theory of quanta*. In contradistinction to this general form of the quantum hypothesis, the original hypothesis of energy-quanta that was formulated by Planck for the phenomena of heat radiation is only a special result of the general quantum postulate adapted to the oscillator. In the preceding, we were relieved from the task of evaluating the phase-integral (15) only because we were able to calculate the area of the ellipses directly from the formula $ab\pi$.

From the oscillator we pass on to the **rotator**. This term is to denote a point-mass m , which rotates about a fixed centre uniformly in a circle of radius a . The natural co-ordinate of position is here the angle ϕ which the radius to the point-mass makes with an arbitrary initial radius $\phi = 0$. We thus set $p = \phi$. The kinetic energy is

$$E_{kin} = \frac{m}{2} a^2 \dot{\phi}^2 \quad . \quad . \quad . \quad . \quad (16)$$

In the case of uniform rotation the potential energy will certainly be independent of ϕ ; it is indifferent to us whether this energy depends on a since a is constant during the motion. Hence we may write

$$E_{pot} = \text{const.}$$

The impulse or momentum co-ordinate in this case corresponding to the co-ordinate q is by (5) and (16) :

$$p = ma^2 \dot{\phi} \quad . \quad . \quad . \quad . \quad (17)$$

It signifies the moment of momentum with respect to the centre of the circular orbit. Since $\dot{q} = \text{const.}$, this moment of momentum (*Impulsmoment*) p is constant during the motion; this, in fact, follows immediately from the equations of motion (4). Therefore the phase-orbit of the rotation (the orbit in the phase-plane $q-p$) is a straight line parallel to the q -axis (Fig. 63). Hence the phase-orbit is not a closed curve in this case. Hence we have here first to define what is to be regarded as the area of the phase-orbit.

The following remark accomplishes this: the phase of the rotator (its position in the orbit and the direction of its momentum or impulse) becomes repeated after every complete rotation. Thus, the true phase-orbit is not an infinitely long straight line but a finite one that repeats itself. In the q -direction the phase-plane of the rotation has only the length 2π ; we may, for example, cut it along the lines $q = \pm \pi$ and join the edges so as to form a cylinder. The surface area of the cylinder between the n^{th} and the $(n - 1)^{\text{th}}$ phase-orbit, being a rectangle on the base 2π , is equal to $2\pi(p_n - p_{n-1})$. We have to set this surface equal to h . We then get for the surface between the n^{th} and the zero phase-orbit, which is represented by the q -axis, the expression

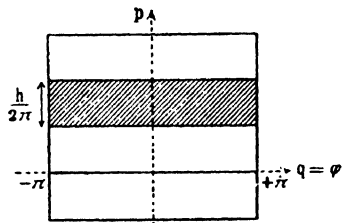

FIG. 63.

$$2\pi p_n = n\hbar \quad . \quad . \quad . \quad . \quad . \quad (18)$$

This is the surface that takes the place of the area of the closed curves in the case of the oscillator.

From this we see that **the rotator is to be quantised not in energy quanta but in quanta of moment of momentum.** In the case of the rotator the moment of momentum must be a whole multiple of $\frac{\hbar}{2\pi}$. If, on the other hand, we calculate the energy (kinetic energy) of the rotator, then it follows from (16) and (17) that

$$E_{kin} = \frac{p\dot{q}}{2}$$

and from (18), when $\nu = \frac{\dot{q}}{2\pi}$,

$$E_{kin} = \frac{n\hbar}{2} \frac{\dot{q}}{2\pi} = \frac{n\hbar\nu}{2} \quad . \quad . \quad . \quad . \quad . \quad (19)$$

Here ν denotes the rotation frequency of the rotator (number of full revolutions per unit of time), which appropriately takes the place of the vibration number of the oscillator. Hence if we wish to speak of energy-quanta $h\nu$ in the case of the rotator, too (which is better avoided

altogether), we should find *its energy to be not a whole multiple, but a half-multiple of the energy-element $h\nu$.*

By quantising the oscillator and the rotator we have already laid the foundation of the numerical details of Bohr's hydrogen atom. As a matter of fact, we shall see later that (18) determines the orbits, in which the electron that belongs to hydrogen circulates round the hydrogen nucleus. In the same way (13) determines the frequency of the radiation that is emitted when the electron crosses from one such orbit to another. But we shall even at this stage set the treatment of the hydrogen atom and other atomic models on a broader basis. To achieve this we pass on from the case of one degree of freedom, to which we were able to restrict ourselves in dealing with the oscillator and the rotator, to the case of *any* number of degrees of freedom. In this case we must demand not *one* quantum condition of the form (15) but *f* different quantum conditions, by which each of the *f* degrees of freedom in a certain sense becomes fixed. We infer this, as a general result, from the perfect sharpness of the spectral lines, which allows us to conclude that the atomic phenomena underlying their origin are fully determinate. For this purpose the author has adopted a direct "heuristic" method,* which leads to the same results as those simultaneously obtained by Planck † as a consequence of a more systematic investigation into the treatment, along quantum lines, of systems of several degrees of freedom. The postulate of the author is: *we must impose the condition (15) on each individual degree of freedom of the system, that is, we must postulate the value of the phase-integral for the k^{th} degree of freedom to be a whole multiple of h :*

$$\int p_k dq_k = n_k h \quad . \quad . \quad . \quad . \quad . \quad (20)$$

A little earlier than the author, W. Wilson ‡ developed the same postulate from the law of heat radiation.

By setting $n_k = 1, 2, \dots$ in turn in (20) we fix the first, second . . . quantised phase-orbit of the k^{th} degree of freedom. Since the system is bound by each of its degrees of freedom to one of these orbits, the required definiteness of its motions is attained. In certain exceptional cases, so-called degenerate cases, the number of the necessary conditions becomes reduced: then, for *f* degrees of freedom, less than *f* quantum conditions already suffice to assure the sharpness of the spectral lines emitted by the system.

* "Zur Theorie der Balmerischen Serie," Sitzungsberichte der Münchener Akademie, Dec., as also 1915, and Jan. 1916, Ann. d. Phys., **51**, 1 (1916).

† M. Planck, "Die Struktur des Phasenraumes," Ann. d. Phys., **50**, 385 (1916).

‡ W. Wilson, "The Quantum Theory of Radiation and Line-spectra," Phil. Mag., **29**, 795, June, 1915. A historical account has been given by N. Bohr, Kopenhagener Akademie, 1918, Teil I, in which a work by Hn. Ishiwara, simultaneous with that of W. Wilson, is referred to.

At this stage we may already state a general property of the phase integral, which is of fundamental importance for all that follows: **the phase-integral J is a necessarily positive quantity; that is, the whole number n in (20) is a positive integer.** This property really follows from the geometrical meaning of the phase-integral in (14) as a surface area (regarded positive) of the (q, p) -plane. But we may easily convince ourselves of this by analysis. For this, it may suffice if we take the case of the oscillator. Here $p = m\dot{q}$, and hence

$$J = \int p dq = \int m\dot{q} dq = \int m\dot{q}^2 dt.$$

In the last integral all factors, in particular also the progress of the time dt , are necessarily positive; hence the phase-integral itself will also be a positive quantity. The proof for the other cases is exactly similar, if the kinetic energy of the system contains only squares (not products) of the velocity co-ordinates: this may always be secured by choosing the co-ordinates suitably, whereby the place of the mass m is taken by a positive function of the co-ordinates.

Concerning the integration limits of the variable q_k in the phase-integral (20), we postulate *that the variable q_k is to traverse the whole region that serves to characterise uniquely the phases of the system.* In the case of a cyclical co-ordinate ($q = \phi$, rotator), this is the region from $-\pi$ to $+\pi$ (cf. Fig. 63, folding of the plane into a cylinder); for a variable radius vector r , it is the region from r_{min} to r_{max} and back again to r_{min} . Further examples of the application of this rule, which clearly arises quite naturally out of the idea of the phases of the motion, will be found in this and in the succeeding chapter.

It is more difficult to decide the question: *which co-ordinates are to be used in forming the phase integral (20)?* It is clear that our general formulation of the quantum theory has a definite and unambiguous sense only if it is supplemented by a rule regulating the choice of the co-ordinates q_k, p_k that are to be used in equation (20) and fixing the choice uniquely. In the simplest cases, which we shall treat in the sequel, in particular in that of Kepler motions in the plane or in space, appropriate co-ordinates offer themselves immediately: namely, the cyclical azimuth ϕ and the radius vector r ; but even here the condition of uniqueness raises difficulties (at least in the non-relativistic treatment; cf. Note 8). In other cases an analytical rule of Schwarzschild and Epstein, which is described in Note 7, serves to determine the co-ordinates. But this rule, too, is restricted and applies only to a definite class of motions (so-called *conditionally periodic motions*). How to proceed in cases which do not fall under this heading is not yet known.

If we recapitulate what we, arguing from the sharpness of spectral lines, have learned about the quantum treatment of the oscillator and the rotator and about the application of quantum methods to general systems, we get

an entirely new type of view of natural phenomena. We thereby adopt the extreme view of the original Planck theory, according to which the quantum favoured states lie solely at the limits of the elementary regions, whereas the interior of these regions remains quite free of phase-points. These quantised states are distinguished from all other possibilities as stationary states of the system by characteristic whole numbers; they do not succeed each other continuously but form a *net-work*. In the quantum orbits an electron moves, if undisturbed, permanently and without resistance, that is, without emitting radiation; the electron is thus, so to speak, rendered immune by the quantum condition as regards the emission of radiation. *The phase-space, being the manifold of all conceivable states, including non-stationary states, is crossed mesh-like by the graph-curves of the stationary orbits. The size of the meshes is determined by Planck's constant h .*

§ 2. Empirical Data about the Spectra of Hydrogen. The Principle of Combination

Before we deal with the spectra of the simplest element H, for which $Z = 1$, it may be convenient to make here some preliminary remarks about spectra in general.

Whereas solid bodies emit a continuous spectrum when they glow, we observe in the case of gases and vapours (except for isolated regions of continuous emission) **line-spectra** and **band-spectra**. The former belong to the atom, the latter to the molecule. Hence in a Geissler tube the hydrogen must first dissociate into atoms before its line-spectrum can appear. In the case of iodine vapour, on the other hand, the band-spectra disappear in proportion as the dissociation of J_2 into J progresses. The line-spectra consist of individual well-defined lines or complexes of lines; the band-spectra appear, if the dispersion is small, as toned bands (often accompanied by "flutings" ("*Kannelierungen*")), but they resolve under higher dispersion into a great number of neighbouring lines.

Within the line-spectra regular sequences of lines may be grouped together into **series**. The distances between successive lines decrease according to definite laws in each series as we proceed towards the violet end, and the lines accumulate at a series limit which is usually accessible only by extrapolation. At the same time the intensity of the lines decreases regularly towards this limit of the series, either, as is the rule, from the beginning of the series, or from a definite point later. The series character is particularly marked in the first three columns of the periodic system (alkalies, alkaline earths, and earths). The lines of a band-spectrum accumulate at the **heads** of the bands, but do not become infinitely dense there as in the case of the series lines at the series limit; the heads of the bands lie partly towards the violet and partly towards the red.

Line-spectra and band-spectra occur during emission as well as during absorption. Indeed, the absorption spectra, in the form of Fraunhofer lines, primarily played the determining part in the historical development of the measurement of wave-lengths. Absorption spectra have a characteristic advantage over emission spectra in that they have a greater number of lines. Whereas, under ordinary conditions, only few lines of the emission series are sufficiently intense to be observed (for example, those of the hydrogen series are known from photographs of nebular clusters as far as the 33rd member of the series, and in vacuum-tubes, at the most as far as the 20th member), the absorption series, also under laboratory conditions, may be counted almost up to the series limit, and they number as many as 50 lines.

In Fig. 64 we show the absorption spectrum of the so-called principal series of sodium according to J. Holtzmark. The wonderful consistency of the series law is brought into full evidence by this picture. The photograph has been cut off at the right end just at the series limit; here the individual lines no longer appear separate. At the left end we see besides the individual absorption lines a continuous absorption band. The line



FIG. 64.

on the left corresponding to the longest wave is not the first line of the Na-series (the well-known yellow D-line), but the line $\lambda = 2823$, which already lies in the ultra-violet region, for the photograph was arranged so as to picture solely the ultra-violet lines. The D-line would lie outside the figure towards the left and, provided the sensitivity of the plate remained the same, would be much more intense still than the darkest line of the photograph.

The first lines of the visible hydrogen spectrum were measured by Fraunhofer as absorption lines of the solar spectrum and were called the C, F, *f*, *h* lines, respectively. Nowadays we call them H_α , H_β , H_γ , H_δ . Their distances apart are shown by wave-numbers (reciprocal wave-lengths) schematically in Fig. 65. In this case, too, we have the same regularity as in that of the Na-spectrum, indeed in a still purer form, since the law of the hydrogen series is essentially an integral law.

It was J. J. Balmer, a teacher at a secondary school in Basel (Bâle), who, at the instigation of Hagenbach, sought out this law and exposed its ideal form so clearly that we have nowadays to make only non-essential improvements on it (cf. the relativity correction in Chap. VIII).

Balmer's formula became the model of all later rational spectral formulae and constitutes the firm foundation of the theory of spectral lines.

Balmer wrote his formula* thus :

$$\lambda = h \frac{m^2}{m^2 - n^2} \quad . \quad . \quad . \quad . \quad . \quad (1)$$

The integral numbers m and n have the values $n = 2, m = 3, 4, 5, 6$, for $H_\alpha, H_\beta, H_\gamma, H_\delta$ respectively. The factor h (which must not, of course, be confused with Planck's constant h) is, according to Balmer, if λ is measured in Ångström units ($1\text{Å} = 10^{-8}$ cms., cf. p. 151), equal to 3645.6.

Nowadays we write Balmer's formula thus (λ in cms., ν in cm.^{-1}):

$$\frac{1}{\lambda} = \nu = R \left(\frac{1}{2^2} - \frac{1}{k^2} \right) \quad \left. \begin{array}{l} R = 109677.69 \\ k = 3, 4, 5, \dots \end{array} \right\} \quad . \quad . \quad . \quad . \quad . \quad (2)$$

Formula (2) arises from (1) (if we disregard the choice of units and the present more exact determination of the numerical factor R) by setting in (1), $n = 2$, and

$$h = \frac{n^2}{R} = \frac{4}{R} \quad . \quad . \quad . \quad . \quad . \quad (3)$$

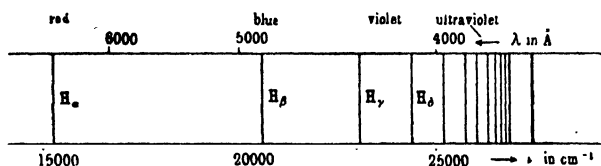

FIG. 65.

Here R is the Rydberg constant (Rydberg-Ritz factor) already introduced earlier. The slight difference in the numerical value of R as now given and as given earlier on page 155 will be explained in § 4 of the present chapter. What accuracy comes into consideration when we write down a number of eight figures may be judged from the fact that the standard metre measure itself is defined only to the extent of several μ 's, that is to the, at the most, 10^{-6} th part of its length.

The fact that the accuracy of Balmer's formula is not overdrawn may be recognised from the following table which gives a comparison, for the

* Ann. d. Phys., 25, 80 (1885). Balmer remarked simply that the wave-lengths of $H_\alpha, H_\beta, H_\gamma, H_\delta$, may be represented in terms of the "basic number" h , quoted in the text, thus:

$$\frac{9}{5}h, \frac{4}{3}h = \frac{16h}{12}, \frac{25}{21}h, \frac{9}{8}h = \frac{36}{32}h.$$

Enlarging the fractions $\frac{4}{3}$ and $\frac{9}{8}$ for H_β and H_δ in the manner shown, he recognised the successive numerators as the squares, $3^2, 4^2, 5^2, 6^2$, and the denominators as the differences of squares, $3^2 - 2^2, 4^2 - 2^2, 5^2 - 2^2, 6^2 - 2^2$. With the discovery of the basic number h Balmer's formula so to speak blossomed into existence.

first seven lines of Balmer's series, of the observed and the calculated* wave-lengths in Ångström units:—

TABLE 24

	$k = 3$	$k = 4$	$k = 5$	$k = 6$	$k = 7$	$k = 8$	$k = 9$
λ calculated . . .	6563.07	4861.52	4340.64	4101.90	3970.24	3889.21	3835.54
λ observed . . .	6563.04	4861.49	4340.66	4101.90	3970.25	3889.21	3835.53

This first example also serves to give the reader an idea of the extraordinary accuracy of spectroscopic measurement—accuracy of calculation and of measurement—which overshadows even the famous “astronomic accuracy.”

Balmer concluded his short account in 1885 with the remark that the discovery of a corresponding “base number” k for elements other than hydrogen would be very difficult, and would be possible only in the case of the most accurate measurement of wave-lengths. How astonished he would have been to learn that the same base number k or, respectively (cf. 3), $R = \frac{4}{h}$, occurs in the spectra of all other elements. To have recognised this is, above all, the achievement of Rydberg, and to a lesser degree, of W. Ritz, who gave a more accurate expression.

The essential feature of Balmer's discovery is the denominator of the formula (1), in that he recognised it as the difference between two integers. From this we get formula (2) giving the difference of two “terms,” the first being the **constant term**, which, at the same time, gives the series limit ($k = \infty$), the second being a **variable term**. This representation as the difference of two terms corresponds to the view of the wave-number as the difference of level between two energy-steps, which we treated in the preceding chapter (p. 187). There, too, we emphasised the point that our real interest is in the terms or energy-steps and not in the term-differences or wave-numbers.

Through his simple formula Balmer showed the way to the most general and most fruitful principle of spectroscopy, which was introduced in 1908 by W. Ritz, who recognised its fundamental importance, under the name, “**Principle of Combination**.” Ritz formulated the principle in his original paper † thus: “By additive or subtractive combination, whether of the series formulæ themselves, or of the constants that occur in them, formulæ are formed that allow us to calculate certain newly discovered lines from those known earlier.” But the fundamental importance of the principle of combination consists of the following: by expressing the

* According to B. Dunz, *Bearbeitung unserer Kenntnis von den Serien*. Diss. Tübingen, 1911, p. 2.

† W. Ritz, *Gesammelte Werke*, published by the Schweizer Physikal. Gesellschaft, p. 162. Paris, Gauthiers Villars, 1911.

wave-number of a spectral line as the difference of two terms, we define two different states or energy-levels of the atom in question. In this way several lines or series of lines determine several atomic states or energy-levels for the same element. The principle of combination now asserts that it is admissible to pass from any one of these levels to any lower level, and to derive from the difference of the two corresponding terms a new wave-number of the element. That this new wave-number happens to be obtained by additive or subtractive combination, as is stated in Ritz's original rule, is unessential. For example, if we represent two lines by means of the term-differences $A - B$ and $C - D$, then we get new lines by combining the terms (BD) and (AC) with the wave-numbers $D - B$ and $C - A$, which cannot thus be derived individually from $A - B$ and $C - D$ by the simple process of addition or subtraction. It is only when two terms of the original lines are themselves equal that the above quoted formulation of the principle of combination suffices.

The principle of combination has maintained itself in the whole region of spectroscopy from infra-red to X-ray spectra as an *exact physical law* with the degree of accuracy that characterises spectroscopic measurement. It constitutes the foundation on which Bohr's theory of spectra rests, and is, in essence, identical with Bohr's law (cf. Chap. I, § 6, eqn. (6)), which likewise taught us to regard the frequency of a spectral emission as the difference between two energy-levels. But not all combinations that may be formed from the terms or energy-levels are equally probable. Rather, there are certain limitations ("rules of selection") that, under certain circumstances, reject certain combinations. It will be the object of the next chapter to found these limitations and to give the conditions of excitation, under which the rules of selection may be transgressed and combinations may be forcefully effected that do not occur of themselves. A first and particularly brilliant test of the principle of combination was offered by the hydrogen spectrum. Even Balmer himself raised the question whether the number n in his formula might not also take the value 3, but the state of spectroscopy at that time did not admit an answer. That is, he suspected lines with the wave-numbers:

$$\nu = R\left(\frac{1}{3^2} - \frac{1}{4^2}\right) \quad \nu = R\left(\frac{1}{3^2} - \frac{1}{5^2}\right), \text{ etc.} \quad (4)$$

Ritz demanded the existence of these lines on the ground of his principle of combination, since the first line of (4) may be obtained by forming the difference of the wave-numbers of H_β and H_α , while the second line may be obtained by forming the difference of H_γ and H_α , and so forth. Thereupon Paschen succeeded in finding in the infra-red region of the hydrogen spectrum intense lines of wave-lengths $\lambda = 18751.3$ and 12817.5\AA , respectively, corresponding exactly to the previously calculated values.

Since then, there is no doubt that Balmer's formula must be written,

remodelled and supplemented as follows (by multiplying numerator and denominator by 4) :

$$\nu = 4R \left(\frac{1}{3^2} - \frac{1}{k^2} \right) \quad k = 4, 5, 6, \dots \quad (6a)$$

$$\nu = 4R \left(\frac{1}{4^2} - \frac{1}{k^2} \right) \quad k = 5, 6, 7, \dots \quad (7a)$$

Written in this way, they come under Balmer's form (5), with the difference that R is replaced by $4R$, a fact that points to the double nuclear charge of He (cf. eqn. (17) of the next paragraph), and with the further difference that the value of R in (6a) and (7a) does not agree exactly with the value of R in (5); this is explained by Bohr's theory of motion of the nucleus (cf. § 4 of the present chapter). But our reasons for denying hydrogen the series (6) and (7) and ascribing them to helium are not only of a theoretical nature, but rest on experimental evidence given by precision measurements of A. Fowler* and F. Paschen,† to which we shall often have occasion to refer.

For the present we assert that the series (6) and (7) occur not only in mixtures of hydrogen and helium, but also in quite pure helium.

We next remark that Pickering's series (7) includes only one-half of the lines represented by (7a), namely, those for which k is odd; the other half coincides nearly, but not quite (on account of the above-mentioned small difference in the value of R) with the ordinary Balmer series. In reality both together form a uniform series in that the lines of the one type arrange themselves according to intensity continuously among the lines of the other type. It is therefore unjustifiable and arbitrary to detach one-half as the Pickering series and to ascribe it to hydrogen. The other half was overlooked earlier only because it could not be separated from the neighbouring true hydrogen lines. Further details on this point are given in § 4, Fig. 69.

The same is true of the relation between the series (6) and (6a). Of the lines represented by (6a), and actually observed, the series formula (6) represents only the members for which k is even. Hence, if we regard the series (6a), in the sense of (6), as the principal series of hydrogen, it becomes arbitrarily subdivided into two parts, of which only the one fits into the terminology of the hydrogen members. Actually, as Paschen shows, both parts as regards the intensity of their lines as well as the nature of their origin belong together, and form a uniform series.

We thus finally find our above assertion confirmed that the simple and integral character of spectral laws expressed in Balmer's formula represents a necessary criterion of hydrogen emission. The spectral laws (6) and (7) that depart from the integral type, and thus do not come

* "Series Lines in Spark Spectra," Proc. Roy. Soc., **90**, 426 (1914), and Phil. Trans., 1914.

† Bohr's Heliumlinien, Ann. d. Phys., **50**, 901 (1916).

under Balmer's formula, do not belong to hydrogen but to ionised helium. Nevertheless, these laws are of the "hydrogen type." They will, therefore, be discussed with Balmer's series in this chapter.

The question arises whether doublets, or, more generally, multiple lines occur in the case of hydrogen as in that of so many other elements (cf. Chap. VI, § 1). Just in the case of hydrogen, this question is not easy to answer, since its lines, at ordinary temperatures, are very blurred, a result which is connected with its small atomic weight (and the consequent greatness of the Doppler effect, cf. Chap. VIII, § 4). Now, older observations of Michelson, Fabry, and Buisson, and more recent ones by Gehrecke and Lau have shown the lines of the Balmer series to be doublets,* of which the difference of wave-lengths are very small (in the case of H_α the doublet is of size, 0.13\AA). From his precision measurements of He^+ , Paschen (cf. p. 208, foot-note 2) calculates the corresponding difference of wave-numbers to be

$$\Delta\nu = 0.3645 \pm 0.0045 \text{ cms.}^{-1} \quad . \quad . \quad . \quad (10)$$

(Concerning the dimensions, cf. eqn. (3) of p. 154). The existence of the doublets of hydrogen cannot yet be explained in this chapter; it led to the elaboration of Bohr's theory described in Chapter VIII. There, too, we shall learn more details of the above-mentioned results of observation.

Besides the Balmer spectrum to be understood in the general sense of equation (5), hydrogen possesses another spectrum of quite a different nature, the so-called "**many-lines spectrum**" (*Viellinienspektrum*). In contradistinction to Balmer's "four-line spectrum" (called so, occasionally, in view of its four lines H_α , H_β , H_γ , H_δ in the visible), the many-lines spectrum is to be regarded as a *band spectrum*, although it does not exhibit the external signs of band-spectra, namely the accumulation of the lines at certain heads of the bands and the repetition of these bands, constituting flutings. From the great number of lines observed, however, individual groups of lines may be separated out, which follow the laws of band lines (set up by Deslandres[†]) and which also show themselves to be related in that they behave similarly in the Zeeman effect. The many-line spectrum arises in the Geissler tube at lower discharging potentials than the Balmer spectrum. The question as to the carrier of the many-lines spectrum is a subject of great controversy. The newest experimental investigations, in particular a work by E. Gehrecke,[‡] leave no room for doubt that its carrier is the hydrogen molecule and not the hydrogen atom. From the point of view of theory, only the H_2 -molecule can come into question at all as the carrier of the many-lines spectrum on account of the great complexity of the latter. Actually, we

* Cf. Chap. VIII, § 4, also for references to the literature.

† Fulcher, *Physikal. Zeitschr.*, 1912, p. 1140; Croze, *Ann. d. Phys.*, 1, 37.

‡ Cf. Report of the *Physikal.-Techn. Reichsanstalt*, 1921.

shall see in Chapter VII that the modern theory of band-spectra, even if it cannot predict quantitatively the frequencies of the many-lines spectrum, can at least completely account for its general character qualitatively if its calculations are based on the mass and size of the H_2 -molecule.

To give the reader at this early stage a general survey of the distribution and density of the lines we give here as a résumé of the empirical data the accompanying curve that has been calculated and drawn by K. Glitscher.* At regular intervals of 100 wave-numbers it gives as ordinates the total intensity of the lines that have been measured in each of these intervals and whose intensity has been estimated. The end-points of the ordinates have been connected by a smooth curve. This curve is the schematic picture of the distribution of intensity in the many-lines spectrum and would be obtained directly if, for example, the action of the Balmer lines were eliminated and the whole spectral region were photographed with a greater width of slit and measured photometrically.

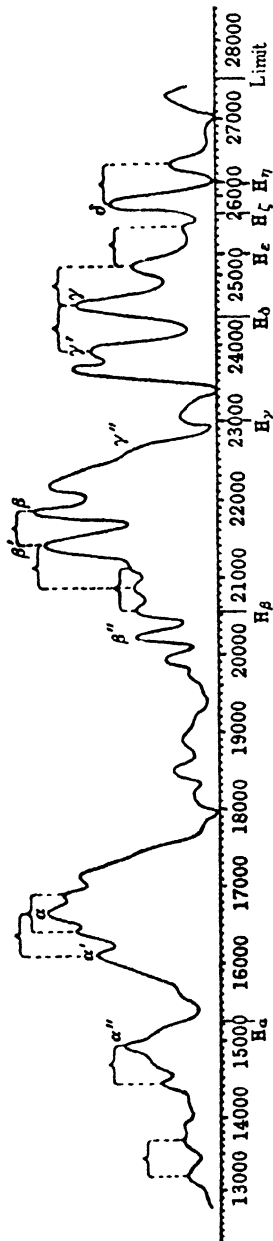

FIG. 66.

If, now, we mark the frequencies of the Balmer lines H_a , H_β , H_γ , H_δ , in their proper positions on a strip of paper as shown on the abscissa of the figure, and if we then slide the strip along the abscissa until H_a coincides with the first principal maximum a (at about 16,600) we find that simultaneously H_β , H_γ , H_δ also coincide with the particularly prominent maxima β , γ , and δ (at about 22,000, 24,600, and 26,000). The principal excrescences (maxima) are attended by minor excrescences. If we next place the strip so that H_a coincides with the minor maximum a' , H_β and H_γ coincide with β' and γ' . Perhaps it would be possible to find a third group of excrescences a'' , β'' , γ'' separated by the corresponding distances of the Balmer

lines. Furthermore, we have grouped into pairs (shown by brackets

* Sitzungsber. d. bay. Akad., 1916, p. 125.

a number of excrescences of which the difference of frequencies is fairly accurate :

$$H_{\zeta} - H_{\epsilon} = R \left(\frac{1}{6^2} - \frac{1}{7^2} \right) \quad (R = \text{Rydberg's number}).$$

A complete theory of the many-lines spectrum would also have to account for the remarkable relationships here indicated between the many-lines spectrum and Balmer's series.

Finally, hydrogen has also a continuous spectrum ; it stretches from the limit of Balmer's series to the ultra-violet ; its carrier is the H-atom. It was first observed in stellar spectra and was then examined more closely by Stark* in canal-ray tubes. This spectrum is also to be interpreted theoretically in Chapter VII.

§ 3. Bohr's Theory of Balmer's Series.

We here make the simplest assumptions possible : a nucleus of negligible size carrying a charge $+e$, an electron of charge $-e$ is considered likewise concentrated at a point, and the mass of the nucleus is considered infinitely great compared with the mass m of the electron ; that is, we are confronted with a "one body problem" instead of the actual "two body problem" ; Coulomb's law is valid and likewise ordinary (pre-relativistic) mechanics ; the electron moves in a circle about the nucleus and is a simple "rotator." Concerning these assumptions we remark that for hydrogen, in particular, $E = e$; the calculation with E is worth doing because it also includes the case of He^+ and Li^{++} (cf. Chap. II, § 3, Nos. 4 and 6). The assumption that the nuclear mass is infinitely great is a good approximation even for hydrogen (according to earlier remarks, cf. eqn. (16) of the following section, $m : m_{\text{H}} = 1 : 1847$) ; but in the next section we shall let this assumption drop.

The orbit of the electron is fixed by two conditions, one prescribed by the classical theory, the other by the quantum theory. The classical theory requires that the external forces be in equilibrium with the inertial forces. The inertial force of circular motion is the centrifugal force :

$$\frac{mv^2}{a} = mrv\omega = ma\omega^2$$

($v = a\omega$ is the linear velocity, ω the angular velocity of the rotating electron, a the radius of the orbit). The only external force is the Coulomb force of electric attraction $\frac{eE}{a^2}$. Hence the condition of the classical theory is :

$$ma\omega^2 = \frac{eE}{a^2}$$

or

$$ma^3\omega^2 = eE \quad . \quad . \quad . \quad . \quad .$$

* Ann. d. Phys., 52, 255, 1917.

The quantum condition is given by the equation for the moment of momentum of the rotator,* namely $2\pi p = nh$ (cf. eqn. (18), § 1 of this chapter).

With our present symbols the moment of momentum takes the form :

$$p = mva = ma^2\omega.$$

Hence we get the quantum condition as :

$$2\pi ma^2\omega = nh$$

$$\text{i.e.} \quad ma^2\omega = \frac{nh}{2\pi} \quad \dots \quad (2)$$

Dividing by (1) and (2) we get

$$v = a\omega = \frac{2\pi eE}{nh} \quad \dots \quad (3)$$

Inserting this value in (2),

$$a = \frac{n^2 h^2}{4\pi^2 m e E} \quad \omega = \frac{8\pi^3 m e^2 E^2}{n^3 h^3} \quad \dots \quad (4)$$

Thanks to our two conditions, then, the two unknowns a and ω are determined. *Both together demand that the electron move only in certain "quantised" circles on the 1st, 2nd, . . . n^{th} "Bohr circle"; n is the "quantum number" of the orbit. The radii of the circles are proportional to the squares of the quantum numbers :*

$$a_1 : a_2 : a_3 : \dots : a_n = 1^2 : 2^2 : 3^2 : \dots : n^2 \quad \dots \quad (5)$$

The times of revolution (periods) τ are inversely proportional to the angular velocities (i.e. $\omega = \frac{2\pi}{\tau}$). The times of revolution in the Bohr circles are proportional to the cubes of the quantum numbers :

$$\tau_1 : \tau_2 : \dots : \tau_n = 1^3 : 2^3 : \dots : n^3 \quad \dots \quad (6)$$

To bring out the analogy with the planetary system still more and to prepare for later generalisations leading to elliptic orbits, we recapitulate our results so far obtained in the form of Kepler's laws :

Kepler's First Law : *The planet moves in a circle at the centre of which the sun is situated. There is a discrete infinite number of orbits; the radius of the n^{th} orbit is given by the quantum number n .*

Kepler's Second Law : *The radius vector from the sun to the planet describes equal areas in equal times. The surface-constant of the n^{th} orbit (which is proportional to our moment of momentum p) is equal to n times Planck's quantum of action.*

Kepler's Third Law : *The squares of the periodic times (of revolution)*

* It is worthy of remark that, before Bohr, J. W. Nicholson (Monthly Notices, 72 (1912), cf. in particular p. 679) set up the quantum condition for the rotator, and used it to interpret certain lines of the sun, as well as of nebulae. Since, however, Nicholson did not determine the emitted radiation in terms of quanta, like Bohr, but only set it equal to the mechanical frequency, his theory is very different from that of Bohr.

are proportional to the cubes of the radii of the orbits. For, by (6) and (5), the time of revolution is proportional to n^3 , and the orbital radius is proportional to n^2 .

As above remarked, for hydrogen, $E = e$. The radius of the first Bohr circle is therefore by (4) in the case of hydrogen :

$$a_1 = \frac{h^2}{4\pi^2 m e^2} \quad \dots \quad (7)$$

We next determine the velocity v_1 in the first Bohr circle and divide it by the velocity of light c . We call the ratio $\frac{v_1}{c}$ simply a . By (3), we get :

$$a = \frac{v_1}{c} = \frac{2\pi e^2}{ch} \quad \dots \quad (8)$$

Using the values * : $c = 4.77 \cdot 10^{10}$, $\frac{e}{m} = 1.77 \cdot 10^7$, $c, h = 6.55 \cdot 10^{-27}$ (cf. p. 37), we get by calculation

$$a_1 = 0.532 \cdot 10^{-8} \text{ cms.} \quad a = 7.29 \cdot 10^{-3} \quad a^2 = 5.31 \cdot 10^{-5} \quad (9)$$

The value of a will be the determining factor, in the last chapter—as the constant of the *fine structure* of spectral lines. From the value of a_1 we get for the diameter $2a$ of the hydrogen atom in its “normal state” the order of magnitude 10^{-8} cms., corresponding to the ideas that were gained about atomic size in other ways (kinetic theory of gases, etc.).

The calculations just given supplement numerically our general data about the hydrogen atom stated in Chapter II, § 3, no. 1. As an illustration we refer to Fig. 18 there drawn. In it we see the first three Bohr circles of radii $a_1, a_2 = 4a_1, a_3 = 9a_1$, represented. The arrows at these circles denote the velocities of revolution $v_1, v_2 = \frac{v_1}{2}, v_3 = \frac{v_1}{3}$ (cf. eqn. (3)); the increasing time of revolution is indicated by the decreasing lengths of the arrows outwards. These quantum-favoured orbits must exist as *stationary* states of motion of the atom; an electron moving in any one of them must not radiate.

We next calculate the energy of the electron in its various orbits and take this opportunity to explain why we just now called the first orbit the normal state of the atom. We again designate the nuclear charge by E . The energy is composed of potential and kinetic energy. The potential (Coulomb) energy is, in view of (4):

$$E_{pot} = -\frac{eE}{a} = -\frac{4\pi^2 m e^2 E^2}{n^2 h^2} \quad \dots \quad (10)$$

* Here and in the sequel e is to be taken as measured in electric “electrostatic” units, as is evident from the above statement for Coulomb's law. According to the concluding remark of Chap. I, § 3, we should therefore multiply the given values of e and $\frac{e}{m}$ by $c = 3.00 \cdot 10^{10}$.

The negative sign indicates attraction. In the case of repulsion we should have to exert work in bringing the electron from infinity up to the nucleus, as in the case of a spring that we set; this would correspond to the positive sign. When the force is attractive, we correspondingly gain energy, and have thus to exert negative work.

In general we have the rule in a Coulomb field (see Note 5) that:

$$E_{kin} = -\frac{1}{2} E_{pot} \quad . \quad . \quad . \quad (11)$$

We can immediately confirm this rule here. For, by (3),

$$E_{kin} = \frac{mv^2}{2} = \frac{2\pi^2 m a^2 E^2}{n^2 h^2} \quad . \quad . \quad . \quad (12)$$

and this is, by (10), actually identical with half of the negative potential energy with the sign reversed. If W denotes the total energy then by (10) and (12)

$$W = E_{kin} + E_{pot} = \frac{-2\pi^2 m c^2 E^2}{h^2} \cdot \frac{1}{n^2} \quad . \quad . \quad . \quad (13)$$

Thus we may supplement our third Kepler law by stating that *the energy constants of the various orbits are inversely proportional to the squares of the corresponding quantum numbers.*

Our way of counting the energy entails that we give to an infinitely great orbit the energy zero. As a result of this the energy constant for all finite paths comes out negative. As we are concerned later only with differences of energy the negative sign causes no difficulty whatsoever, although it appears to contradict the nature of energy. But, as already remarked on page 158, we should immediately arrive at a positive value for the energy if we were really to calculate the total energy of the moving electron, and thus count besides the kinetic and potential energies also, for example, the "proper" energy contained in the field of the electron. According to the view of the theory of relativity (cf. Chap. VIII, § 1, or Chap. II, § 6, p. 95) the latter energy is simply equal to mc^2 , that is, equal to an amount of energy, which is many times greater than the other parts of the energy and which would therefore make the sign of the total amount positive. In the same way, we could include the still considerably greater positive proper energy of the nucleus. But since these proper energies are constant, they naturally cancel when we form energy-differences and they are, therefore, more conveniently left out of account from the very outset.

Our energy-constant W has the algebraically smallest value in the first (innermost) orbit. If we call it W_1 , then in the 2nd and 3rd orbits, respectively, we have $W_2 = \frac{1}{4} W_1$ $W_3 = \frac{1}{9} W_1$. These amounts are $> W_1$, since $W_1 < 0$. Hence the electron can be lifted from an inner to an outer orbit only by an **addition of energy**. It can fall from an outer to an inner orbit when it **loses energy**. The innermost orbit is therefore

most stable and represents, as we said earlier, the **normal state** of the rotating electron.

Bohr's theory has two quantum sources; it arises, as we stated in § 1 of this chapter, out of the quantum condition for the *rotator*, on the one hand, and the *oscillator*, on the other. So far, we have used only the first condition. The quantum condition for the oscillator comes into force now when we turn our attention to the radiation of the atom.

We arrive at our goal by the shortest route, which is also essentially the most expedient one, by referring to photo-electric phenomena. These were brought together under Einstein's law (cf. Chap. I, § 6) and were extended as far as Bohr's *frequency condition* for spectral emission (*loc. cit.* equ. (6)) :

$$h\nu = W_a - W_b \quad (14)$$

This equation states that if the atom passes over from an initial state of energy W_a to a final state of lesser energy W_b , then the excess of energy is radiated out in the form of a monochromatic wave of light, the frequency ν of which is determined by just this eqn. (14). Each such transition thus causes an emission of well-defined light and is observed as a sharp spectral line. How the change of the liberated atomic energy into light-energy is effected is still a matter of mystery. In the next chapter we shall, indeed, investigate this phenomenon more closely from the point of view of Maxwell's theory and shall draw from it inferences about the polarisation of the resulting light-wave. In doing so, however, we do not *derive* eqn. (14) in our reasoning but use it as our basis of argument. As we already emphasised earlier in dealing with Einstein's law, it is impossible to derive this equation from the idea of continuous electromagnetic fields.

Merely to satisfy the wish for a physical interpretation we give an account of a view of eqn. (14) that is taken from an essay by L. Flamm.* But this view is in no wise to be regarded as a necessary foundation of the equation, as is already evident from the auxiliary assumptions that are to be noted specially in what follows, but merely as a means of visualising the phenomenon involved.

In addition to the atom, which excites the radiation, we suppose an "ether" to exist, which transmits the radiation. Nowadays we like to avoid speaking of the ether, since the theory of relativity has deprived it of its material existence in the older sense (cf. Chap. VIII, § 1). Here we use the word ether to signify no more than that "*states of vibration*" are possible that are propagated with the velocity c , as they are presented to us on all sides in experience and are described more closely in the theory of electrodynamic optics. In this sense we define the ether as an oscillator. But the oscillator "ether" differs (apart from the spatial arrangement and the space-time distribution of its vibrations, with which

* *Physikal Zeitschr.*, **19**, 116 (1918); cf., in particular, p. 125.

we are not concerned here), from the harmonic oscillator introduced on page 196, essentially in that it is capable of executing vibration of any frequency ν , that is, it can transmit radiation of any colour. The ether therefore represents not *one* oscillator but an infinite *system* of oscillators in which the proper frequency varies continuously from oscillator to oscillator; it is, so to speak, a system of organ pipes with infinitely small differences of pitch.

We suppose such a system of oscillators to be placed next to an atom. When the atom radiates, it is linked with this system of oscillators and transfers energy to it. The atom does not, indeed, radiate when in its stationary states of motion; but when an electron jumps from one orbit to another, when it passes from an orbit further removed from the nucleus to one that is nearer, energy is liberated. The sharpness of the spectral lines points to the fact that this energy becomes converted into *monochromatic* energy of vibration (**first assumption**), that is, that it excites only one definite ether oscillator of our system. Which oscillator is this? The answer is given by the quantum condition of the oscillator: that oscillator will respond, for which the energy set free by the atom equals a whole multiple (integral number) of its energy elements. Assuming this integral number to be 1 (**second assumption**), we have to set the energy element of our ether oscillator equal to the energy $W_n - W_k$ set free by the atom. Thus we again arrive at our eqn. (14).

In (14) we insert the value of (13) for the energy. Let n be the quantum number for the final orbit, and $k (> n)$ that of the initial orbit. We then get:

$$\nu = \frac{2\pi^2 m e^4}{h^3} \left(\frac{E}{e} \right)^2 \left(\frac{1}{n^2} - \frac{1}{k^2} \right) \quad \dots \quad (15)$$

Now $E = e$ in the case of hydrogen, and if we set

$$R = \frac{2\pi^2 m e^4}{h^3} \quad \dots \quad (16)$$

we get from (15) exactly *Balmer's series in its general form* (5) on page 207. For other atoms of the hydrogen type (He^+ , Li^{++} , etc.) $R = Z^2 e$, where Z is, as earlier, the nuclear charge or the atomic number of the atom. For such atoms we get, correspondingly, from (15):

$$\nu = RZ^2 \left(\frac{1}{n^2} - \frac{1}{k^2} \right) \quad \dots \quad (17)$$

But the sweeping success of Bohr's theory is not founded only on the derivation of Balmer's formula, but especially on the numerical calculation of the Rydberg-Ritz constant R that occurs in it. Before Bohr, A. E. Haas,* in particular, had already proved the universal nature of this constant, and had shown how it was very probable that it could be

(† * Sitzungsber. Wiener Akad., March, 1900.

expressed in terms of h and electronic data. But Bohr's theory first brought complete clearness by giving the relation (16). If we use the values given on page 213 :

$$e = 4.77 \cdot 10^{-10} \quad e/m = 1.77 \cdot 10^7 \cdot c \quad h = 6.55 \cdot 10^{-27}$$

then it follows that

$$R = 3.27 \cdot 10^{15} \text{ sec.}^{-1} \quad (18)$$

Hereby it is to be noted that when we set the energy-element of the oscillator equal to $h\nu$, we take ν to mean the vibration number in the ordinary sense, having dimensions sec.^{-1} . But, for spectroscopic reasons, we have wished to take ν as meaning the wave-number, i.e. the reciprocal of the wave-length, having dimensions cm.^{-1} . We therefore contrast as on page 154 in eqns. (3) and (4) :

$$\text{the proper vibration number or frequency, sec.}^{-1} \quad \nu = \frac{c}{\lambda}$$

$$\text{the improper frequency or the wave-number, cm.}^{-1} \quad \nu = \frac{1}{\lambda}$$

Accordingly we have yet to divide our formulæ (15) and (16) by $c = 3 \cdot 10^{10}$, to get from the proper vibration number to the spectroscopic wave-number. Consequently, there results from (16) and (18)

$$R = \frac{2\pi^2 m e^4}{h^3 c} = 1.09 \cdot 10^5 \text{ cms.}^{-1} \quad (19)$$

This value of R agrees, except for the last, not quite certain, figure with the observed value in eqn. (2) of page 204, in which $R = 1.09678 \cdot 10^5$. Bohr's theory is thus confirmed very strikingly.

We shall now continue to reverse the sequence of results and use the theoretical formula for Rydberg's constant to correct one of the data occurring in it, namely e , m or h . We actually know Rydberg's number to a degree of accuracy that we can never hope to attain in measurements of e , $\frac{e}{m}$ or h . This leads us to the *problem of spectroscopic units*, which we shall, however, be able to solve only when in the next section we have deepened the theory of Rydberg's constant. The problem is to **calculate the universal constants e , $\frac{e}{m}$, h from purely spectroscopic data with "spectroscopic accuracy."**

In Fig. 67 we once more summarise Bohr's theory graphically. The ultra-violet (Lyman) series ($n = 1$), the visible Balmer series ($n = 2$), and the infra-red Paschen-Ritz series ($n = 3$) appear in it as counterparts to the K-, L-, M-series of the X-ray spectra in Fig. 47. The fact that Fig. 67 requires, on account of the "Principle of Selection," a correction (namely elliptic orbits in place of circular orbits) will be accounted for in Chapter V. at the close of § 2. The figure shows, just like the calculation (eqn. (4) of this section) how greatly the size of the hydrogen atom

increases with the value of the quantum number n . Bohr* recognised in this an explanation of the fact that the higher members of Balmer's series, even in highly evacuated tubes, are most often not to be observed, but are only known through spectra of nebulae. He argued in this way: the mean distance between the atoms (which is essentially their mean free path) must be greater than the diameter of the outer orbit of the electron concerned in the production of the spectral line, if it is to be possible for this line to be emitted at all at the gas-density in question. For the 33rd line of Balmer's series this distance would have to be greater than $1.2 \cdot 10^{-5}$ cms. and this would correspond to a gas pressure of less than 0.02 mm. of mercury. In this way it seemed possible to find an upper limit for the pressure of the hydrogen gas in nebulae which radiate out Balmer's series.

More recent observations, however, as J. Franck † points out, have demolished this view and its cosmological inference. The appearance of the higher lines of the series is dependent above all on the energy of excitation of these lines, which is necessary according to the $h\nu$ -law, being supplied to the atom. When the pressure is not very small, however, the frequent collisions prevent larger amounts of energy from being collected in the exciting atom, unless the collisions, as in the case of He, N_2 and other gases of small electro-affinity, take place without loss of energy. Under such circumstances (e.g. if we have very little H_2 in He of, say, 40 mm. pressure) we find that in spite of the small free path and frequent disturbances of the paths, the series lines are emitted very richly.

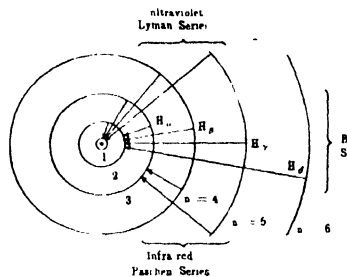

FIG. 67.

The wealth of lines of the absorption series to which we called attention on page 203 and represented in Fig. 64, is explained in the same way; in the beam of light that is absorbed all wave-lengths and therefore all quantities of energy $h\nu$ are present. Hence all absorption lines occur at the same time.

§ 4. Relative Motion of the Nucleus

Our confidence in the theory of the hydrogen spectrum developed in the preceding paragraph becomes strengthened if we can show that certain more detailed inferences that result from Bohr's picture of the phenomenon of emission are confirmed by experience.

In the preceding section the nuclear mass was assumed to be infinite

* Phil. Mag., 26, 9 (1913).

† Zeitschr. f. Phys., 1, 1 (1920).

and the nucleus itself was assumed to be at rest. We now take into account that the mass of the nucleus is finite and then see that it, too, will move. Our first Kepler Law on page 212 will now accordingly be enunciated thus:

The planet and the sun each move in a circle about their common centre of gravity.

In Fig. 68 let m be the mass of the planet, M that of the sun. According to the law of conservation of the centre of gravity, the centre of gravity S of m and M remains at rest. m and M move on their circles at the ends of a common diameter with the common angular velocity ω . Let a be the distance Sm , A the distance SM . Then

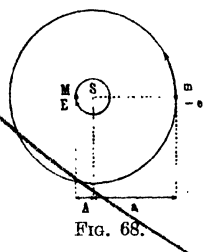

FIG. 68.

$$am = AM \quad (1)$$

from which it follows

$$a = (a + A) \frac{M}{M + m}, \quad A = (a + A) \frac{m}{M + m} \quad (2)$$

The classical condition (p. 211) now requires that the Coulomb attraction is equal not only to the centrifugal force of the planet, but also to that of the sun. Thus

$$ma\omega^2 = MA\omega^2 = \left(\frac{eE}{a + A}\right)^2$$

This double equation reduces, on account of (1), to a simple equation. By substituting a from (2) and by using μ as the "resultant" mass of m and M , namely

$$\mu = \frac{Mm}{M + m} \quad (3)$$

we get

$$\mu(a + A)^3\omega^2 = eE \quad (4)$$

We have also the following definition equivalent to (3)

$$\frac{1}{\mu} = \frac{1}{m} + \frac{1}{M} \quad (5)$$

The quantum condition next becomes added to the classical condition. This deals with the moment of momentum p of the rotator. The latter quantity is composed of the moment of momentum of the planet $ma^2\omega$ and that of the sun $MA^2\omega$, thus:

$$p = ma^2\omega + MA^2\omega.$$

By eqns. (1), (2), and (3) we write for p successively:

$$p = ma(a + A)\omega = \frac{mM}{M + m}(a + A)^2\omega = \mu(a + A)^2\omega$$

The quantum condition requires that: $2\pi\rho = n\hbar$, thus we get

$$\mu(a + A)^2\omega = \frac{n\hbar}{2\pi} \quad \dots \quad (6)$$

Equations (4) and (6) agree with equations (1) and (2) of the preceding section, with the exception that μ and $a + A$ takes the place of m and a . Consequently we may use the solutions for these equations obtained from (4) of the previous section. The result is:

$$a + A = \frac{n^2\hbar^2}{4\pi^2\mu e E^2}, \quad \omega = \frac{8\pi^2\mu e^2 E^2}{n^3\hbar^3} \quad \dots \quad (7)$$

The potential energy between the sun and the planet is now (cf. (10) of the preceding section):

$$E_{pot} = -\frac{eE}{a + A} = -\frac{4\pi^2\mu e^3 E^2}{n^2\hbar^2}$$

The kinetic energy is again half the potential energy with reversed sign (this theorem is proved in Note 5 at the end of the book for moving nuclei, too), hence the total energy is:

$$W = E_{kin} + E_{pot} = -\frac{2\pi^2\mu e^2 E^2}{n^2\hbar^2} \quad \dots \quad (8)$$

The circumstance that μ , the "resultant" mass of the sun and planet enters into this equation, points to the fact that we are now concerned with the energy-constant of the common motion of both masses (their relative motion). For this common motion there is a discrete series of quantised states of motion that are singled out of the manifold of all states of motion by the quantum number, in exactly the same way as previously for the cases in which the planetary orbits were alone considered.

We now consider a transition from an initial state of motion (with the energy-constant W_n , quantum number k) to a final state of motion (with the energy-constant W_n , quantum number $n < k$) and assume that the energy set free again becomes transformed into monochromatic radiation, according to eqn. (14) of the previous section. The energy set free is derived now, not only from the planet but also from the sun during the transition; the sun's orbit alters simultaneously with that of the planet in a ratio definitely fixed by the change in the quantum numbers. The spectral formula obtained in this way is clearly again eqn. (15) of the previous section, but with μ in place of m . Consequently we get for Rydberg's constant

$$R = \frac{2\pi^2\mu e^4}{h^3} = \frac{2\pi^2 m e^4}{h^3 \left(1 + \frac{m}{M}\right)} = \frac{R_\infty}{1 + \frac{m}{M}} \quad \dots \quad (9)$$

Here we have inserted the value of μ out of eqn. (3), whereby the denominator was divided by M . The symbol R_∞ recalls the earlier value of R in eqn. (16) of the previous paragraph, which was actually obtained under the assumption that $M = \infty$. Eqn. (9) contains the following remarkable result:—

Owing to the relative motion of the nucleus Rydberg's constant becomes reduced in the ratio $\left(1 + \frac{m}{M}\right) : 1$. Rydberg's constant is least for hydrogen, for which its value is

$$R_H = \frac{R_\infty}{1 + \frac{m}{m_H}} \quad \dots \quad (10)$$

Its value for helium is greater, being

$$R_{He} = \frac{R_\infty}{1 + \frac{m}{m_{He}}} = \frac{R_\infty}{1 + \frac{1}{4} \frac{m}{m_H}} \quad \dots \quad (11)$$

and, for increasing atomic weight, approaches the universal limit R_∞ , which is independent of the atomic weight, and which was designated as Rydberg's constant simply by R in the previous section.

This result, too, we owe to Bohr. He remarked at once that from the spectroscopic determination of R_H and R_∞ , or, what is easier to carry out in practice, from the determination of R_H and R_{He} , the quantity m/m_H could be obtained. It actually follows from (10) and (11) that

$$\frac{m}{m_H} = \frac{R_{He} - R_H}{R_H - \frac{1}{4}R_{He}} \quad \dots \quad (12)$$

The determination of m/m_H in eqn. (12) is equivalent to the determination of the specific electronic charge e/m . We actually have

$$\frac{m}{m_H} = \frac{e/m_H}{e/m} \quad \dots \quad (13)$$

Now, e/m_H is the specific ionic charge, the electrochemical equivalent* of § 2, Chapter I, that is, a quantity that is very accurately known (its value is 96,494 Coulombs). An exact spectroscopic determination of m/m_H denotes at the same time an exact knowledge of e/m , one that is presumably

* Strictly speaking, the difference between m_H and $m_H^* = 1.008m_H$ ought to be taken into account; we called attention to this difference in the foot-note at the conclusion of Chapter III, § 3. In the relative motion of the nucleus we are dealing with the true mass m_H^* of the hydrogen atom, not with the mass of the imaginary hydrogen atom $m_H = 1/L$, to which we refer our quantities in electrolysis when we define the chemical equivalent charge. Consequently in eqn. (13) m_H would, strictly, have to be replaced by m_H^* , and e/m_H would have to be taken equal to 96494/1.008. In the same way, in eqn. (10), we should have to write m_H^* in place of m_H , but not in eqn. (11)—for the true atomic weight of He is equal to four times the ideal, not the true, atomic weight of H. As a result of this a correction should also be applied to eqn. (12), too, and this has to be taken into account if we are carrying out exact numerical calculations, but we may express this correction in the text.

more accurate than can ever be obtained from experiments on the deflection of cathode rays. We have thereby come a step nearer to the goal that we set up as the problem of spectroscopic units in the preceding section: Instead of using the one value of $R = R_{\infty}$ in eqn. (16) of the previous section, we use the two values R_H and R_{He} out of the above eqns. (10) and (11), and we get, instead of one, two equations for determining the three universal units e , e/m , and h . The necessary third such relation we shall get to know in the last chapter.

We must next broach the question how the difference between R_H and R_{He} may be made evident in practice. This is made possible by the series of ionised He, of which we spoke in § 2.

Ionised helium is of the type of hydrogen (*wasserstoffähnlich* = hydrogen-like). It consists, like the H-atom, of a nucleus and of an electron and differs from it, at first sight, only in having a double nuclear charge. Accordingly its spectral lines are contained in the general formula (17) of Balmer's type, mentioned in the previous section, if we set $Z = 2$ in it. But on closer inspection a finer difference, which is at

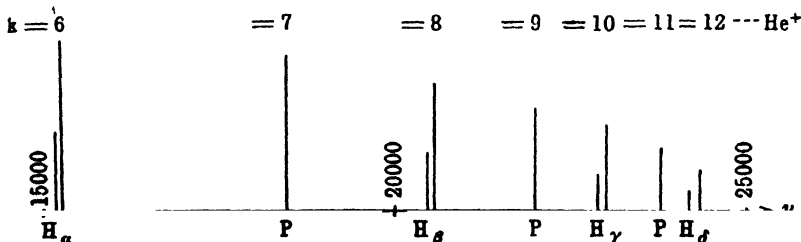

FIG. 69.

present of essential importance to us, is the difference in the nuclear mass. This mass is not, as in the case of hydrogen, m_H , but m_{He} . Consequently the earlier $R = R_H$ is to be replaced by R_{He} . From eqn. (17) of the previous paragraph, there thus arises in this way, if we set $n = 4$:

$$\nu = 4R_{He} \left(\frac{1}{4^2} - \frac{1}{k^2} \right) \begin{cases} R_{He} \left(\frac{1}{2^2} - \frac{1}{m^2} \right) \dots & k = 2m \\ R_{He} \left(\frac{1}{2^2} - \frac{1}{(m + \frac{1}{2})^2} \right) \dots & k = 2m + 1 \end{cases} \quad (14)$$

The subdivision into two parts (which is not really contained in the nature of the matter in question) brings into evidence the circumstance that the component for which k is even ($k = 2m$) coincides very nearly with Balmer's series, whereas the other part ($k = 2m + 1$) has the form of Pickering's series that was given earlier in eqn. (7) of page 207. The combination of the two partial series (which conforms with the nature of the matter in hand) into one uniform series corresponds to the earlier formula (7a) on page 208.

In Fig. 69 we exhibit the positions of the He⁺-lines relatively to the Balmer lines. The length of the lines is to denote diagrammatically their intensity, on the assumption that we are dealing with a mixture of He⁺ and of H. For this reason the Balmer lines are drawn shorter than the neighbouring He⁺-lines. The difference in the position of the two series corresponds to the difference between R_{He} and R_H . Since $R_{He} > R_H$, the helium lines, as compared with the Balmer lines are displaced a little towards the violet end. The lines P of Pickering's series, that is, the helium lines $k = 2m + 1$, arrange themselves between the helium lines $k = 2m$, and, as emphasised on page 208 in order of steadily increasing intensity.

The researches of Paschen mentioned on page 208 give for the wave-lengths of the helium lines and the neighbouring Balmer lines the following values (here cut short at the first decimal place) in Ångström units, which confirm the displacement towards the violet, as predicted by theory.

TABLE 25

	He ⁺	H
$k = 6$	6560.1	6562.8 (H _α)
$k = 7$	5411.6	—
$k = 8$	4859.3	4861.3 (H _β)
$k = 9$	4561.6	—
$k = 10$	4338.7	4340.5 (H _γ)
$k = 11$	4199.9	—
$k = 12$	4100.0	4101.7 (H _δ)

According to our whole development of the question, this violet shift of the helium lines with respect to the Balmer lines may be regarded as a certain indication of the relative motion of the nuclei during the stationary forms of motion of the atom, or, more accurately, of the slightly different relative motion of the heavier helium nucleus compared with that of the lighter hydrogen nucleus. *The differences between the lines, as exhibited in Fig. 69, depict the small distances between the centres of gravity shown in Fig. 68. At the same time they give us definite information to the effect that in our intra-atomic planetary system the law concerning the persistence of the common centre of gravity remains in force.*

It need hardly be mentioned that this exhaustive test of our atomic model is possible only thanks to the extraordinary accuracy of spectroscopic methods, by means of which differences of wave-length of $\frac{1}{2}$ in a million can still be determined with absolute certainty.

Of the series of ionised helium we have considered in detail that which has the final quantum number $n = 4$ (Pickering's series), in § 2 that with the final quantum number $n = 3$ (Fowler's series) was touched

on lightly. Also some of the representatives of the series with the final quantum number $n = 2$ have been measured. The succession of its lines is identical with that of the ordinary Balmer series except for the factor $\left(\frac{R}{e}\right)^2 = 4$. The lines in question therefore lie in the extreme ultra-violet; their wave-lengths are obtained from H_α, H_β, \dots by dividing by 4 (as long as we disregard the small difference in the constants R , thus:

$$\begin{aligned} \nu &= 4R\left(\frac{1}{2^2} - \frac{1}{3^2}\right), & \lambda &= \frac{6560}{4} = 1640, \\ \nu &= 4R\left(\frac{1}{2^2} - \frac{1}{4^2}\right), & \lambda &= \frac{4859}{4} = 1215. \end{aligned}$$

The wave-lengths 1640 and 1215 Å have been found by Lyman* in the spectrum of helium. On the other hand, the prospects of proving the existence of the He⁺-lines with the final quantum number $n = 1$ are unfavourable, since their wave-lengths are only a quarter of those of the Lyman series, which themselves already lie in the extreme ultra-violet.

From the difference in the wave-lengths of the He⁺-lines and the H-lines, or from the wave-lengths of all the He⁺-lines that he measured, Paschen determined the value of R_{He} and R_H . He found (we here purposely give all the decimal places of the numbers):

$$\begin{aligned} R_{He} &= 109722.144 \pm 0.04 \\ R_H &= 109677.691 \pm 0.06 \end{aligned} \quad (15)$$

According to eqn. (12), we may calculate † from these values (cf. also the correction remarked on in the footnote to eqn. (13)):

$$\frac{m_H^*}{m} = 1847, \quad \frac{e}{m} = 1.769 \cdot 10^7 c \quad (16)$$

The latter value is almost identical with one obtained from the Zeeman effect, that is by a semi-spectroscopic method (measurement of a wave-length + the measurement of a magnetic field) and probably represents the at present most accurate value of this quantity. According to eqns. (10) or (11) we follow Paschen or Flamm, respectively, in deducing from R_H or R_{He} that

$$R_e = 109737.11 + 0.06 \quad (17)$$

In the series of spectra of the hydrogen type there would now become linked with the H- and the He⁺-spectrum that of Li⁺⁺, namely of doubly ionised lithium. This Li⁺⁺ again consists of a nucleus and one

* Nature, **104**, 565 (1920).

† Cf. L. Flamm, Physikal. Zeitschr., **18**, 518 (1917). The values calculated by Paschen differ from those given above by some millionths, since he takes the atomic weight of He as 3.99 instead of 4.00.

electron; its spectrum falls under the general category of the spectra of the hydrogen type, but with $Z = 3$. The relative motion of the Li-nucleus, that is:

$$m_{Li} = 6.94 m_H, \quad R_{Li} = \frac{R_\infty}{1 + \frac{m}{m_{Li}}} = \frac{R_\infty}{1 + \frac{1}{6.94} \frac{m}{m_H}}$$

we write this equation in the two forms:

$$\left. \begin{aligned} \nu &= 9 R_{Li} \left(\frac{1}{n^2} - \frac{1}{k^2} \right) \\ \nu &= R_{Li} \left(\frac{1}{(n/3)^2} - \frac{1}{(k/3)^2} \right) \end{aligned} \right\} \quad (18)$$

The first of these forms is the more natural one; in the second, the triple nuclear charge of the Li causes the deceptive occurrence of the denominator 3 in the series formula, just as that of the denominator 2 in the case of He^+ , which led to its lines being wrongly interpreted as the "principal series" and "second subsidiary series" of hydrogen. Unfortunately, these series of Li^{++} have not yet been observed in the laboratory. Bohr has, however, shown that it is probable that individual lines in certain nebulae of the Wolf-Rayet type may have this origin. These constellations show characteristically Pickering's series particularly intensely. Their physical state therefore seems to favour the ionisation of the atoms and might therefore lead to the production of Li^{++} . But since these series have not yet been discovered completely in these nebulae, we shall not enter into the numerical calculations of Bohr's conjecture here.

§ 5. The $K\alpha$ -line of Röntgen Spectra. The Model of the He-nucleus

Continuing from the preceding reflections on the spectra of He^+ and Li^{++} , we shall proceed further in the sequence of spectra of the hydrogen type, and, indeed, at once as far as elements of any arbitrary atomic weight. Let us assume for a moment that the element of atomic number Z had been deprived of all its electrons except one by intensive ionisation, or, what comes to the same thing, suppose all its electrons but one had been removed from the neighbourhood of the nucleus to the periphery of the atom, then the orbits described by this remaining electron in the vicinity of the nucleus would be governed by the same simple laws as in the case of the hydrogen electron, and the spectra that result from the jumps between these orbits would again be determined by eqn. (17) of page 216. We shall be able to identify the Rydberg number R that occurs here with our R_D . For the quantum numbers n and $k > n$ we shall insert the simplest values $n = 1, k = 2$. We then get

$$\frac{\nu}{R} = Z^2 \left(\frac{1}{1^2} - \frac{1}{2^2} \right) \quad (1)$$

In this we first call attention to the fact that the factor Z^2 , especially in the case of the heavier elements, brings this vibration number out of the visible region far into the ultra-violet. Even in the case of hydrogen ($Z = 1$), the line defined by (1) belongs to the Lyman ultra-violet series (cf. p. 207). As Z increases, the corresponding line passes over into the *Röntgen or X-ray region*. As an actual fact, eqn. (1) represents essentially the principal line of the K-series of the X-ray spectrum, namely the $K\alpha$ -line. In Chapter III, § 5, we deduced for this line, by an empirical method, Moseley's formula (7) of page 157 :

$$\nu_R = (Z - 1)^2 \left(\frac{1}{1^2} - \frac{1}{2^2} \right) \dots \dots \dots (2)$$

The difference between the eqns. (1) and (2) consists essentially in the substitution of $Z - 1$ for Z . Without attaching importance to this for the present, we shall rather direct our attention to the general agreement between what our theory led us to expect, leading to eqn. (1), and the empirical datum expressed in eqn. (2). We may then make the assertion : *Independently of the more detailed structure of the atom, the field of the nuclear charge predominates in its interior. The electron which produces the $K\alpha$ -line behaves in the main as if it confronted the nucleus alone. The spectral formula of the $K\alpha$ -line is essentially of the simplest type, that of hydrogen.*

To arrive at a closer understanding of the $K\alpha$ -emission, we shall follow the example of Debye* and drop the assumption that all electrons except one have been removed from the vicinity of the nucleus. Rather, we know from § 4 of the preceding chapter that in the excitation preparatory to the K-emission, only one electron is taken out of the K-shell and removed to the periphery of the atom. This one missing electron is then replaced in the K-ring from the next following L-ring when the $K\alpha$ -line is produced. Let p be the normal number of electrons in the K-shell, q that in the L-shell. We imagine both as *circular rings* and suppose the p or q electrons, respectively, distributed at equidistant intervals along them. The initial and final state of the atom in the K-emission may then be characterised by the following scheme :—

	K-ring	L-ring
Initial state	$p - 1$	q
Final state	p	$q - 1$

The outer rings that follow the L-ring are to be left out of consideration in this, since they are not (or at least not essentially) brought into question by the $K\alpha$ -emission.

Our next step is to evaluate the energy constants W for the K- and the L-ring, at first for the normal distribution of the electrons. We assert that they are given by :

* Physikal. Zeitschr., **18**, 276 (1917).

$$\left. \begin{aligned} \text{K-ring: } W &= -p \frac{Rh}{1^2} Z_{eff}^2, & Z_{eff} &= Z - s_p, \\ \text{L-ring: } W &= -q \frac{Rh}{2^2} Z_{eff}^2, & Z_{eff} &= Z - p - s_q \end{aligned} \right\} \quad (3)$$

and that at the same time the radii of the rings, as calculated from eqn. (5) on page 74 are given by :

$$\left. \begin{aligned} \text{K-ring: } a &= \frac{1^2 a_1}{Z_{eff}}, & Z_{eff} &= Z - s_p, \\ \text{L-ring: } a &= \frac{2^2 a_1}{Z_{eff}}, & Z_{eff} &= Z - p - s_q \end{aligned} \right\} \quad (4)$$

in which a_1 , is the radius of the first Bohr circle for hydrogen, and s_p, s_q , denote the quantities introduced on page 75.

To prove our assertions we set up, exactly as on page 211, the classical and the quantum condition for the determination of a and ω , the radius and the angular velocity, whether in the K-ring or the L-ring. In deriving the classical condition, we fix on any one electron of those in the ring for which we are making the calculation and let this be subject not only to the centrifugal force and the attraction of the nucleus but also to the repulsion exerted by electrons of the same ring as that to which the selected electron belongs. The latter repulsion, by eqns. (9) and (10) of page 75 ($n = p$ or q , for the K- or L-ring respectively) amounts to :

$$\frac{e^2}{a^2} s_n, \quad s_n = \frac{1}{4} \sum_{k=1}^{k=n-1} \frac{1}{\sin \frac{\pi k}{n}}$$

In the case of the L-ring there becomes added also the repulsion exerted by the inner K-ring on the selected electron of the L-ring. If we suppose the K-ring, as an approximation, contracted into the nucleus, the repulsion is expressed simply by $\frac{e^2 p}{a^2}$. The classical condition therefore becomes

$$\left. \begin{aligned} \text{for the K-ring: } ma\omega^2 &= \frac{e^2 Z}{a^2} - \frac{e^2 s_p}{a^2} = \frac{e^2 Z_{eff}}{a^2} \\ \text{for the L-ring: } ma\omega^2 &= \frac{e^2 Z}{a^2} - \frac{e^2 p}{a^2} - \frac{e^2 s_q}{a^2} = \frac{e^2 Z_{eff}}{a^2} \end{aligned} \right\} \quad (5)$$

in which Z_{eff} has the same significance as in (3) and (4).

Let the quantum condition be the same as in the case of hydrogen ; it requires that every electron of the K-ring rotate with one quantum of moment of momentum, and every electron of the L-ring with two such quanta. Thus

$$\left. \begin{aligned} \text{K-ring: } ma^2\omega &= \frac{h}{2\pi} \\ \text{L-ring: } ma^2\omega &= \frac{2h}{2\pi} \end{aligned} \right\} \quad (6)$$

As is evident, the present conditions (5) and (6) arise from the earlier eqn. (1) of page 211, and (2) of page 212, if we set in the latter

$$E = eZ_{e\sigma} \text{ and } n = 1, \text{ or } = 2, \text{ respectively} \quad (7)$$

For this reason we may also take the value of a for this equation out of the eqn. (4) of § 3. But the latter becomes our present eqn. (4), if we compare our present and the former eqn. (7). Our eqn. (4) is thereby proved.

To pass on to eqn. (3), that is, to calculate the energy, we first write down the potential energy of the nucleus and (in the case of the L-ring) that of the K-electrons (that are nearer the nucleus) for the individual electron, namely:

$$-\frac{e^2Z}{a} \text{ and } +\frac{e^2p}{a}$$

Next, the potential energy of the electrons of the ring under consideration with respect to the selected electron (belonging to the same ring) is, by eqn. (12) of page 75 ($n = p$ or q for the K- and L-ring, respectively):

$$\frac{2e^2s_n}{a}$$

The potential energy with respect to all the electrons of the ring in question therefore becomes (cf. also eqn. (13) of p. 75):

$$\left. \begin{array}{l} \text{K-ring: } p \frac{e^2Z}{a} + p \frac{e^2s_p}{a} = p \frac{e^2Z_{e\sigma}}{a} \\ \text{L-ring: } q \frac{e^2Z}{a} + q \frac{e^2p}{a} + q \frac{e^2s_q}{a} = q \frac{e^2Z_{e\sigma}}{a} \end{array} \right\} \quad (8)$$

But the expressions to be proved, contained in (3), arise from these if we insert the value of (a) from (4) and take into account that here, too (cf. Note 5) the total energy is equal to one-half of the potential energy.

The radiation emitted when the atom passes from the initial state to the final state is governed by Bohr's frequency condition:

$$h\nu = W_a - W_e \quad (9)$$

By inserting here the values from (3), the terms relating to the final state appear with a positive sign, those relating to the initial state appear with a negative sign. Concerning the different meaning of $Z_{e\sigma}$ for the initial and the final state, we refer to the above scheme for the generation of the K α -radiation. We get from (9):

$$\frac{\nu}{R} = p \frac{(Z - s_p)^2}{1^2} - (p-1) \frac{(Z - s_{p-1})^2}{1^2} + (q-1) \frac{(Z - p - s_{q-1})^2}{2^2} - q \frac{(Z - p + 1 - s_q)^2}{2^2} \quad (10)$$

The result so obtained looks much more complicated than our eqn. (1) to which we were led by generalising directly Balmer's formula. Th

fact that a closer relation... becomes clear when we develop... explanation. We showed that the consideration only the motion of an electron

$$R = Z^2 \left(\frac{1}{2^2} - \frac{1}{2^2} \right) \dots \left(\frac{1}{D_p} - \frac{1}{D_q} \right)$$

in which we use the abbreviations :

$$D_p = ps_p - (p - 1) s_{p-1}, \quad D_q = qs_q - (q - 1) s_{q-1},$$

$$C = ps_p^2 - (p - 1) s_{p-1}^2 + (q - 1) \frac{(p + s_{q-1})^2}{4} - q \frac{(p + 1 + s_q)^2}{4}$$

Thus we see: eqn (1) is the first member of the development of eqn. (10) in powers of Z. The fact that the K-emission is of the hydrogen type, is explained not only if we assume provisionally as above, that, as in the case of hydrogen, a single electron effects this emission, but also if we assume our present picture of electronic rings that are occupied by several electrons.

Our next step would be to choose our integers p and q so as to obtain as close a connexion as possible between eqn. (10) and the observations of the Ka-line. According to J. Kroo,* this is attained by using the values :

$$p = 3, \quad q = 9. \quad (12)$$

This connection is noteworthy but it is not perfect. We show this in the following table calculated by Siegbahn.† The first column contains the

TABLE 26

Z	Theor.	Exper.	Δ
17 Cl	192.73	193.12	- 0.39
19 K	248.76	244.06	- 0.30
20 Ca	271.60	271.86	- 0.26
21 Sc	300.99	301.22	- 0.23
24 Cr	398.55	398.78	- 0.23
26 Fe	471.49	471.58	- 0.09
27 Co	510.34	510.45	- 0.11
28 Ni	550.80	550.73	+ 0.07
29 Cu	592.85	592.75	+ 0.10

elements and their atomic numbers ; the second contains the theoretical values of $\frac{\nu}{R}$ according to Kroo's assumption (12), in which, however, the relativity correction is taken into account, which was already mentioned on page 158 but which will not be set on a firm foundation till we get to the final chapter. The formulæ, completed in this way, are constructed quite analogously to eqns. (10) and (11), but differ from them by

* Physikal. Zeitschr., 19, 307 (1918).
 † Ann. d. Phys., 59, 72 (1919). This is the same essay as that already quoted on page 152, in which Siegbahn describes the method of his precision measurements.

terms of small numerical value, that contain higher powers of Z and that are due to the change of the electronic mass with high velocities. The third column contains the experimental values of ν/R in agreement with our Table 11. The fourth column contains the difference Δ between the theoretical and the experimental values. It shows that the course of the values is regular and increases linearly with Z . It is impossible to eliminate Δ by choosing other values for p and q . Is it possible to explain it by refining further the above scheme of calculations?

Continuing from Kroy's essay, the author has pointed out* that, strictly speaking, not only the proper energies of the K-ring and the L-ring, but also the mutual action between these rings themselves and also with respect to the outer rings have to be taken into account, and that the outer rings, which were neglected in our calculation, by contracting or expanding, according to the electrons present in the inner rings, likewise contribute amounts of energy to the emission of Röntgen rays. Moreover, these energies, due to mutual action, depend on whether the rings are imagined co-planar (lying in one plane), or with their planes inclined to one another in space. It was possible to prove, however, that, although these amounts of energy were not negligible in themselves, they, for the most part, cancelled one another.

On the other hand the question arises, whether the notion of plane rings can be more than a rough approximation of the true arrangements. We are inclined, at the outset, to answer in the negative. We shall expect, not plane rings, but spatial shells (e.g. 8-shells, cf. p. 203). From the point of view of the periodic system, the numbers $p = 3$, $q = 9$ certainly do not inspire confidence. Rather, in conformity with the whole structure of the system of elements, we must demand that $p = 2$ for the K-shell, and $q = 8$ for the L-shell. Furthermore, we must demand that the same numbers p and q , with which we represent the $K\alpha$ -emission, and the corresponding and fixed distribution numbers for the outer shells account for not only the $K\alpha$ -line, but also for the remaining lines of the K-spectrum as well as those of the L- and M-spectrum. Many tentative calculations in this direction, in particular by L. Vegurd, show that this is impossible even if moderate accuracy and completeness is aimed at.

But there is another fundamental feature that must prevent us from proceeding along the way that we have started along. The whole calculation of this paragraph depends on the assumption that the q -electrons of the L-shell are equivalent as regards their energy. This assumption is certainly not right, as our later critical investigation of the "elliptic complex" (*Ellipsenverein*) in Chapter VIII, § 5, will show, and it leads to absurd consequences.

As a result of this, the detailed explanation of the $K\alpha$ -line here attempted has only limited importance. The similarity between Balmer'

* Physikal. Zeitschr., 19, 299 (1918).

and Moseley's formula demands an explanation. We showed that the term in Z^2 furnishes the clue, whether we consider only the motion of a single electron, or whether we consider the transition of an electron between shells occupied by several electrons. The *similarity of X-ray spectra with those of the hydrogen type* extends thus far; but it does not furnish a complete theory of the energy-levels of Röntgen rays.

Nor can we claim to have obtained final results in the next matter of discussion, in which we are concerned with an experiment leading into the region of nuclear physics, namely, in finding the quantum elaboration of our **model of the helium nucleus**. Following the suggestion of Lenz, we described this on page 97 as an inverse oxygen model, of which an illustration was given in Fig. 23. It has two negative electrons separated by a distance $2b$, surrounded by four positive electrons or H-nuclei (protons), the latter being distributed at equal distances along a circle of radius a , and rotating with the uniform angular velocity .

We have two classical and one quantum condition for determining the three unknowns a , b , ω .

First, we have the condition of equilibrium for the negative electrons under the action of their mutual repulsion, and of their attraction towards the four positive electrons (protons), both according to Coulomb's law. The repulsion amounts to $e^2/4b^2$; the attraction due to a single H-nucleus is $e^2/(a^2 + b^2)$, and has the component $e^2b/(a^2 + b^2)^{3/2}$ in the axial direction. Hence the condition of equilibrium when four nuclei are present is :

$$\frac{e^2}{4b^2} = \frac{4e^2b}{(a^2 + b^2)^{3/2}}$$

From this it follows that :

$$\left. \begin{aligned} (a^2 + b^2)^{3/2} &= 16b^3, & a^2 + b^2 &= 16^{2/3}b^2 \\ b^2 &= \frac{a^2}{16^{2/3} - 1}, & a^2 + b^2 &= \frac{16^{2/3}a^2}{16^{2/3} - 1} \end{aligned} \right\} \quad . \quad . \quad (13)$$

Then we have the mechanical condition of equilibrium for one of the rotating positive electrons. Its centrifugal force is $m_H a \omega^2$. The component of attraction, due to the individual negative electron, in the radial direction amounts to $e^2 a / (a^2 + b^2)^{3/2}$; it must be doubled owing to the presence of the two negative electrons. The repulsion due to the three remaining electrons likewise acts in the radial direction, and is given, according to eqns. (9) and (10) on page 75, by $e^2 s_4 / a^2$, where s_4 has the value 0.957, according to Table 3. Hence the condition of equilibrium of the positive electrons in the radial direction is :

$$m_H a \omega^2 = \frac{2e^2 a}{(a^2 + b^2)^{3/2}} - \frac{e^2}{a^2} s_4 \quad . \quad . \quad (14)$$

If we insert the value of $a^2 + b^2$ from (13), it follows that

$$m_H a^3 \omega^2 = e^2 \left[\frac{1}{s^3} (16^{2/3} - 1)^{3/2} - s_4 \right] = 0.58e^2 \quad . \quad . \quad (15)$$

Finally, we apply the quantum condition for the rotation of the positive electrons (or protons). As in eqn. (6), we assume in the case of the K-ring that each electron rotates with an amount of energy equal to one rotation-quantum. We then have

$$2\pi m_H a^2 \omega = h \quad . \quad . \quad . \quad . \quad (16)$$

The essential difference between this and the determination of the size of the hydrogen atom in § 3 consists in the fact that the mass m of the negative electron is replaced by the 2000 times greater mass m_H of the positive electron. *The result is that the radius a of our model of the helium nucleus is about 1000 times smaller than the radius a_1 of our model of the hydrogen atom.* For we get from (15) and (16), by eliminating ω :

$$a = \frac{1}{0.58} \sqrt[4]{\frac{h^2}{2e^2 m_H}}$$

or, taking into consideration the significance and the size of the hydrogen radius a_1 in eqns. (7) and (9) on page 213, and the value of $\frac{m}{m_H}$ in eqn. (16) on p. 224, we get

$$a = \frac{m}{m_H} \frac{a_1}{0.58} = \frac{1}{1847} \cdot \frac{0.53 \cdot 10^{-8}}{0.58} = 5.0 \cdot 10^{-12} \text{ cms.} \quad . \quad (17)$$

The same quantum condition that determined the correct atomic size of the model of the hydrogen atom leads to the result that our model of the helium nucleus becomes of sub-atomic size and that it shrinks, compared with the former model in the ratio $\frac{m}{m_H}$.

According to Rutherford's experiments on deflections of α -rays, certainly, the true extent of the helium nucleus is markedly smaller, namely $3 \cdot 10^{-13}$ cms. We may explain our different result on the ground that at such small distances and with such concentrations of energy Coulomb's law no longer remains valid (cf. p. 97), or by admitting that the details of our model are not yet correct. In any case, our calculation is worthy of notice, since it gives a hint as to how the smallness of the dimensions of the nucleus and the holding together of the nuclear parts comes about. As a matter of fact we have the firm conviction that the quantum theory holds sway even in the interior of the nuclei, and that the structure of the nuclei is governed by the same quantum laws as govern the structure of the atoms.

§ 6. Elliptic Orbits in the Case of Hydrogen.

In § 4 we subjected the model of the hydrogen atom to a first test by demanding that the law of the persistence of the common centre of gravity should hold for the two-body problem: nucleus + electron. This leads to an elaboration of the first Kepler law and to a refinement of the

definition of Rydberg's number. We next apply a second test to our hydrogen model, by asserting that *elliptic orbits are possible as well as circular orbits*. In this sense we enunciate Kepler's first law in its complete astronomical form :

The planet moves in an ellipse at one focus of which the sun is situated.

In this formulation of Kepler's law we have for the present disregarded the relative motion of the nucleus ; we can easily make up for this little imperfection later.

Our chief concern is to select from the manifold of all mechanically possible elliptic orbits those that are possible according to the quantum theory. The motion in the elliptic path represents a problem of *two degrees of freedom*, since the position of the electron is determined by two co-ordinates, most simply by the polar co-ordinates measured from the nucleus, namely the azimuth ϕ and the radius vector r . We then get for the element of orbit ds of the electron

$$ds^2 = dr^2 + r^2 d\phi^2.$$

Hence the kinetic energy becomes

$$E_{kin} = \frac{m}{2} \left(\frac{ds}{dt} \right)^2 = \frac{m}{2} (\dot{r}^2 + r^2 \dot{\phi}^2) \quad . \quad . \quad . \quad (1)$$

and the potential energy becomes (we here again denote the nuclear charge for the present E)

$$E_{pot} = - \frac{eE}{r} \quad . \quad . \quad . \quad (2)$$

Corresponding to the position co-ordinates $q = \phi$ and $q = r$, respectively, we define the corresponding **impulse co-ordinates (momentum co-ordinates)** in accordance with § 1 of this Chapter (p. 195), namely

$$p = \frac{dE_{kin}}{dq} \quad . \quad . \quad . \quad (3)$$

We denote these impulse co-ordinates by p_ϕ and p_r , and then we get, on account of (1) and (3),

$$p_\phi = m r^2 \dot{\phi}, \quad p_r = m \dot{r} \quad . \quad . \quad . \quad (4)$$

where p_ϕ is the moment of the momentum mv , namely the product of the perpendicular distance r and the azimuthal component $m r \dot{\phi}$ of the momentum, and p_r is directly the radial component $m \dot{r}$ of the momentum (cf. Fig. 70, in which the component \dot{r} of the velocity in the direction of the radius vector and the component $r \dot{\phi}$ perpendicular to it in the direction of ϕ increasing are shown). According to Kepler's second law ("the radius vector sweeps out equal areas in equal times"), p_ϕ is a constant during the motion, the so-called "areal constant." We indicate this by setting in future

$$p_\phi = p \quad . \quad . \quad . \quad . \quad (5)$$

In our general formulation of the quantum theory, § 1 of this Chapter, eqn. (20), the quantum conditions for our system of two degrees of freedom are :

$$\int_{\phi=0}^{\phi=2\pi} p_{\phi} d\phi = n\hbar \quad \int_{r_{min}}^{r_{max}} p_r dr = n'\hbar \quad . \quad . \quad . \quad (6)$$

The limits of the integrals correspond to the rule for limits given on p. 201. They include the full range of values of the position co-ordinates, namely, in the case of ϕ , the region from $\phi = 0$ to $\phi = 2\pi$, and, in the

case of r , the region from r_{min} to r_{max} and then back to r_{min} again, for which in the case of the closed elliptic orbit, too (but not in the case of an open orbit, such as we shall later have to consider), we may again write $\phi = 0$ and $\phi = 2\pi$. For we want to ascribe to the perihelion, r_{min} the azimuth $\phi = 0$ (cf. Fig. 70); $\phi = \pi$ then corre-

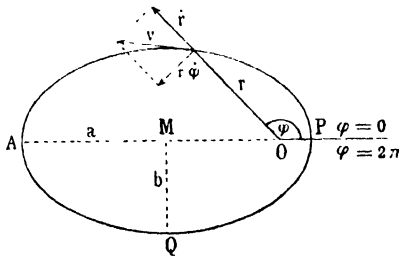

FIG. 70.

sponds to the aphelion r_{max} . In the return to the perihelion ϕ again increases to the value $\phi = 2\pi$. The first equation (6) will be called the **azimuthal quantum condition**, the second equation (6) will be called the **radial quantum condition**.

On account of (5) the first equation (6) becomes

$$2\pi p = nh \quad . \quad . \quad . \quad (7)$$

namely, *the quantum condition of the rotator given earlier* (eqn. (18) on p. 199). The second equation (6) has to be restated in terms of the orbital equation of the ellipse.

According to elementary analytical geometry we write this equation in polar co-ordinates thus :

$$\frac{1}{r} = C_1 + C_2 \cos \phi \quad . \quad . \quad . \quad (8)$$

To determine the constants C_1 and C_2 that have for the present been left indeterminate, the following relations are used (cf. Fig. 70) :

- | | |
|-------------------------------------|---|
| Major axis | $a = MP = MA,$ |
| Eccentricity | $a\epsilon = OM,$ |
| Numerical value of the eccentricity | $\epsilon = \frac{OM}{MP},$ |
| Minor axis | $b = MQ = a\sqrt{1 - \epsilon^2},$ |
| Perihelion | $\phi = 0, r = r_{min} = OP = a(1 - \epsilon),$ |

hence, on account of (8),

$$\frac{1}{a(1 - \epsilon)} = C_1 + C_2 \quad . \quad . \quad . \quad (9)$$

Aphelion

$$\phi = \pi, r = r_{max} = OA = a(1 + \epsilon),$$

and hence, on account of (8),

$$a(1 + \epsilon) = C_1 - C_2 \quad \dots \quad (10)$$

From (9) and (10) we get

$$C_1 = \frac{1}{a} \frac{1}{1 - \epsilon^2}, \quad C_2 = \frac{1}{a} \frac{\epsilon}{1 - \epsilon^2},$$

and eqn. (8) becomes :

$$\frac{1}{r} = \frac{1}{a} \frac{1 + \epsilon \cos \phi}{1 - \epsilon^2} \quad \dots \quad (11)$$

From this it follows by logarithmic differentiation with respect to ϕ :

$$\frac{1}{r} \frac{dr}{d\phi} = \frac{\epsilon \sin \phi}{1 + \epsilon \cos \phi} \quad \dots \quad (11a)$$

In the radial quantum condition (6) we now write, in view of (4) and (5),

$$\left. \begin{aligned} p_r &= m\dot{r} = m \frac{dr}{d\phi} \cdot \dot{\phi} = \frac{p}{r^2} \frac{dr}{d\phi} \\ dr &= \frac{dr}{d\phi} d\phi \end{aligned} \right\} \quad \dots \quad (12)$$

On account of (11a) we therefore get

$$p_r dr = p \left(\frac{1}{r} \frac{dr}{d\phi} \right)^2 d\phi = p\epsilon^2 \frac{\sin^2 \phi d\phi}{(1 + \epsilon \cos \phi)^2}$$

and our radial quantum condition becomes

$$p\epsilon^2 \int_0^{2\pi} \frac{\sin^2 \phi}{(1 + \epsilon \cos \phi)^2} d\phi = n'h$$

or, on account of (7),

$$\frac{\epsilon^2}{2\pi} \int_0^{2\pi} \frac{\sin^2 \phi}{(1 + \epsilon \cos \phi)^2} d\phi = \frac{n'}{n} \quad \dots \quad (13)$$

The left side depends only on the eccentricity ϵ . That is, ϵ is determined by the two integral quantum numbers n and n' . In Note 6, eqn. (7), at the end of the book, it is shown that by carrying out the integration in (13) we get :*

$$\frac{1}{\sqrt{1 - \epsilon^2}} - 1 = \frac{n'}{n}, \text{ that is, } 1 - \epsilon^2 = \left(\frac{n}{n + n'} \right)^2 \quad \dots \quad (14)$$

The areal constant p determines the *size* of the ellipse, the eccentricity ϵ determines its *form*. Hence, through the azimuthal and radial quantum

* W. Wilson derived the above eqns. (13) and (14) a little earlier than the author from his general formulation of the quantum conditions quoted on page 200 (Wilson's essay in Phil. Mag., 31, 161 (1916) was completed in Nov. 1915, the author's was finished in Dec. 1915). But no application of these equations to Balmer's series have been made by Wilson.

condition, eqns. (7) and (14), the size and form of the elliptic orbit is fixed in accordance with the quantum theory. *From the continuous manifold of all possible ellipses there are thus selected a family of quantised ellipses, given by the two positive integers n and n' .*

We next turn to the calculation of the energy. The kinetic energy is, by (1), (4), (5) and (12).

$$E_{kin} = \frac{m}{2} (\dot{r}^2 + r^2 \dot{\phi}^2) = \frac{1}{2m} (p_r^2 + \frac{p_\phi^2}{r^2}) = \frac{p^2}{2mr^2} \left[\left(\frac{1}{r} \frac{dr}{d\phi} \right)^2 + 1 \right] \quad (15)$$

If we here use (11) and (11a), we get

$$\begin{aligned} E_{kin} &= \frac{p^2}{2ma^2(1-\epsilon^2)^2} [\epsilon^2 \sin^2 \phi + (1 + \epsilon \cos \phi)^2] \\ &= \frac{p^2}{ma^2(1-\epsilon^2)^2} \left(\frac{1+\epsilon^2}{2} + \epsilon \cos \phi \right) \end{aligned} \quad (15a)$$

On the other hand we have, by (2) and (11),

$$E_{pot} = -\frac{eE}{r} = -\frac{eE}{a} \frac{1 + \epsilon \cos \phi}{1 - \epsilon^2} \quad (16)$$

The sum of the kinetic and the potential energy must be independent of the time, and hence also of ϕ , namely it must equal the energy constant W . From this it follows that the factor of $\epsilon \cos \phi$ in this sum must vanish. This gives

$$\frac{p^2}{ma^2(1-\epsilon^2)^2} = \frac{eE}{a(1-\epsilon^2)}, \quad a = \frac{p^2}{meE(1-\epsilon^2)} \quad (17)$$

The value of a obtained in this somewhat indirect and artificial way might have been obtained more directly from differential equations of the problem, but we wished to avoid writing down the latter. By re-writing the value of a by means of (7) and (14) and adding the value of $b (= a\sqrt{1-\epsilon^2})$, we get

$$a = \frac{\hbar^2}{4\pi^2 meE} (n + n')^2, \quad b = \frac{\hbar^2}{4\pi^2 meE} n(n + n') \quad (18)$$

On the other hand, by using (15a) in (17) and then adding (16), we get

$$W = E_{kin} + E_{pot} = \frac{eE}{a(1-\epsilon^2)} \left(\frac{1+\epsilon^2}{2} - 1 \right) = -\frac{eE}{2a} \quad (19)$$

If we insert in this the value of a from (18), we have

$$W = -\frac{2\pi^2 me^2 E^2}{\hbar^2} \frac{1}{(n + n')^2} \quad (20)$$

This result is of the greatest consequence and is superlatively simple: *we have found for the energy of the elliptic orbits the same value as in eqn. (13) on p. 214 for circular orbits, with the one difference that the quantum number n in the latter case is replaced by the quantum sum, $n + n'$.*

Each of the quantised ellipses of our family has an amount of energy equivalent to that of a definite Bohr circle.

We next consider an ellipse of the family as the initial orbit—let its quantum numbers be k and k' —, and another as the final orbit—with the quantum numbers n and n' . In order that the transition may be free and accompanied by the emission of energy, we must certainly have $k + k' > n + n'$ (cf. eqn. (20), in particular as regards the signs). We calculate the energy radiated out according to the $h\nu$ -law (Bohr's Frequency Condition). We get a result quite analogous to eqn. (15), page 216:

$$\nu = \frac{2\pi^2 m e^4}{h^3} \left(\frac{H}{e}\right)^2 \left(\frac{1}{(n + n')^2} - \frac{1}{(k + k')^2} \right) \quad (21)$$

For hydrogen $H = e$, this simplifies, if we introduce Rydberg's number R , to:

$$\nu = R \left(\frac{1}{(n + n')^2} - \frac{1}{(k + k')^2} \right) \quad (22)$$

From the point of view of practical results, this spectral formula again gives only Balmer's series, but *it has a deepened theoretical significance and its origin has now multiple roots. By the admission of our elliptic orbits the series has gained no extra lines and has lost none of its sharpness.*

When the author, early in 1916, developed the above theory, he referred at the outset to a series of indices* by which the various possibilities of generation contained in a Balmer line may be made manifest.

1. In the natural state of the H-atom without a super-imposed field the various possibilities of generation coincide only accidentally, as it were, in one line. But if we allow an electric field to act on the luminous atom, in the manner practised by Stark, the original quantum orbits will be disturbed. It is evident that the disturbance will affect the various ellipses differently; it will therefore alter the energy of the various orbits differently in each case. The result is the so-called **Stark effect**, to which we shall return in the next chapter. 2. Similar consequences follow from the application of a magnetic field and the result is the **Zeeman effect**. Here, too—both in our theory and in the older view based on the classical theory—the resolution of the lines is not due to new possibilities of vibration being generated but to the circumstance that lines which were originally coincident are differently displaced and hence separated by the magnetic field. We shall also study the Zeeman effect in the next chapter for the case of the hydrogen atom. 3. The most beautiful and most instructive manifestation of the various elliptic orbits that belong to the same Balmer line is, however, given by Nature herself without our agency in the fine structure of space-time conditions as reflected in **the fine structure of spectral lines**. The

*Sitzungsberichte der Münchener Akademie, 1915, p. 425, cf., in particular, § 6.

last chapter will deal with this subject. 4. The coincident lines in the case of hydrogen may be separated by an inner atomic field in place of an external electric or magnetic field. Such an inner atomic field does not, indeed, occur in the case of hydrogen itself or atoms of the hydrogen type (an electron and a nucleus, singly or multiply charged) but in the case of all other atoms (neutral He, Li, etc.). In the next chapter but one we shall see that such atomic fields are the cause of the one Balmer series of hydrogen in the elements not of the hydrogen type splitting up into the series systems: Principal Series, First and Second Subsidiary Series, etc.

We now enumerate the various possibilities of circular and elliptic orbits that belong to a given value of $n + n'$. To begin with, we remark that: (a) $n' = 0$ denotes a circular orbit. For when $n' = 0$, then by eqn. (14), $\epsilon = 0$, and the focus and centre of the ellipse coincide, that is, the ellipse degenerates into a circle. This could also be read off more directly from the radial quantum condition (6), which shows that when n' vanishes, p_r , that is \dot{r} , also vanishes, and hence r must be constant.

(b) $n = 0$ denotes a degenerate ellipse; it is the focal distance counted twice. For when $n = 0$ we get from (14), $\epsilon = 1$, i.e. the perihelion and the aphelion coincide with the two foci. This follows more directly, too, from the azimuthal quantum condition (6) and its connection with the areal constant p . This denotes the area swept out by the radius vector in the unit of time. If this is to vanish,* the orbit must degenerate into a double line with a zero areal content. But the electron, in describing this orbit would fall into the nucleus. Owing to the permanence of atoms we regard this as impossible. Thus we declare the orbit $n = 0$ to be impossible and do not include it among the following orbits. In Fig. 71 it is indicated by a dotted line.

The number of possibilities that belong to a given value of $n + n'$, for example, $n + n' = 3$, is obtained from the apparently not very subtle equation of resolution:

$$3 = n + n' = 3 + 0 = 2 + 1 = 1 + 2.$$

We thus have three possibilities; the fourth, $3 = 0 + 3$ is excluded as being fictitious by what was said under (b). In all three cases we have for hydrogen, by eqn. (18) ($E = e$, $a_1 = \frac{h^2}{4\pi^2 m e^2}$ = radius of the first Bohr circle), the same a , namely $a = a_1 \cdot 3^2$.

On the other hand, b , by the same eqn. (18), changes in steps thus:

$$b = a_1 \cdot 3 \cdot 3, \quad b = a_1 \cdot 2 \cdot 3, \quad b = a_1 \cdot 1 \cdot 3..$$

* We are here concerned with the limit $p = 0$. If we set $p = 0$ directly, that is, if we let the electron fall into the nucleus without a blow from the side, then if we suppose the nucleus to be penetrable, the electron could oscillate pendulum-like to equal distances on the other side and back, moving to and fro. In reality, of course both the orbits line $p = 0$ and simply $p = 0$ are to be rejected.

After this, the following tabulation with the illustrations of Fig. 71 will be immediately intelligible:—

$$\begin{array}{l}
 n + n' = 1, \text{ one possibility.} \\
 n = 1 \quad n' = 0 \quad a = a_1 = b \\
 \text{Circle.}
 \end{array}$$

$$\begin{array}{l}
 n + n' = 2, \text{ two possibilities.} \\
 n = 2 \quad n' = 0 \quad a = 2^2 a_1 \quad b = a \\
 n = 1 \quad n' = 1 \quad a = 2^2 a_1 \quad b = a\sqrt{2}
 \end{array}$$

A circle, or an ellipse of eccentricity $\epsilon = \frac{\sqrt{3}}{2}$.

$$\begin{array}{l}
 n + n' = 3, \text{ three possibilities.} \\
 n = 3 \quad n' = 0 \quad a = 3^2 a_1 \quad b = a \\
 n = 2 \quad n' = 1 \quad a = 3^2 a_1 \quad b = \frac{5}{3} a \\
 n = 1 \quad n' = 2 \quad a = 3^2 a_1 \quad b = \frac{1}{3} a
 \end{array}$$

(Circle, or ellipses of eccentricities $\epsilon = \frac{\sqrt{5}}{3}$ or $\epsilon = \frac{\sqrt{8}}{3}$.)

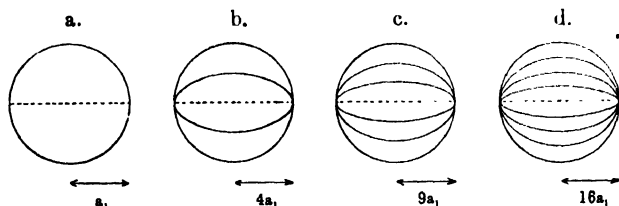

FIG. 71

$$\begin{array}{l}
 n + n' = 4, \text{ four possibilities.} \\
 n = 4 \quad n' = 0 \quad a = 4^2 a_1 \quad b = a \\
 n = 3 \quad n' = 1 \quad a = 4^2 a_1 \quad b = \frac{5}{4} a \\
 n = 2 \quad n' = 2 \quad a = 4^2 a_1 \quad b = \frac{3}{4} a \\
 n = 1 \quad n' = 3 \quad a = 4^2 a_1 \quad b = \frac{1}{4} a
 \end{array}$$

Circle or ellipses of eccentricities $\epsilon = \frac{\sqrt{7}}{4}$, $\epsilon = \frac{\sqrt{12}}{4}$, or $\epsilon = \frac{\sqrt{15}}{4}$.

The figures here drawn do not exactly correspond with reality: in the first place, for the sake of economising space, we have not drawn them to the same scale (cf. the accompanying arrows $a_1, 4a_1$, etc.); secondly, to give a better survey of the curves we have drawn them concentrically instead of confocally. But if we keep the position of the nucleus fixed in the figure, then, not the centres, but the foci in which the nucleus (at rest) is situated, coincide. In this way there result from Fig. 71 the following figures which bring out the true conditions better.

Now that we have investigated the various possibilities for the single orbit when $n + n'$ is given, we can immediately state the number of

possibilities for the transition from an initial orbit (with a given $k + k'$) and a final orbit (with a given $n + n'$). In general this number is equal to the product $(n + n')(k + k')$, for example, in the case of the He ϵ -line, $\frac{\nu}{4R} = \frac{1}{3^2} - \frac{1}{4^2}$, it is equal to the product $3 \cdot 4 = 12$ (combination of one of the four initial orbits of the fourth drawing of Fig. 72 with one of the three final orbits of the third drawing of Fig. 72). In the same way we get for the Balmer series the following number of possibilities of generation:—

H^{α}	H^{β}	H^{γ}	H^{δ}
2. 3	2. 4	2. 5	2. 6

In thus enumerating all these possibilities of production we do not wish to affirm that they are all realised in nature. In the next chapter we shall develop a “**Principle of Selection**” which separates out from the totality of the possible transitions between orbits those that can excite the emission of radiation. So far our enumeration has started purely from the possibilities in the atom. Through the linking up of the atom with

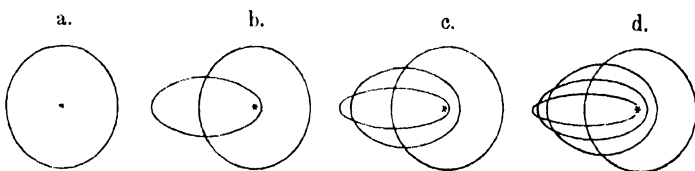

FIG. 72.

the “ether” both in respect to energy and impulse, several of these possibilities become fictitious.

The relative motion of the nucleus that has so far been disregarded may be added in the case of elliptic paths just as easily as in that of circular orbits. From the equations of motion of the nucleus and the electron separately we form, as for the astronomical Kepler problem, the equations for the relative motion of the electron with respect to the nucleus. These differ from the equations of motion for when the nucleus is at rest, in that the “**resultant mass**” μ (eqn. (3) on p. 220) takes the place of the electronic mass m . The same holds for the azimuthal and the radial quantum condition. We first postulate that the sum of the phase-integrals calculated for the motion of the electron and for that of the nucleus, both for the ϕ as for the r co-ordinate, is equal to a multiple (n or n') of h , and therein we express the corresponding distances between the centre of gravity in terms of the distance between the electron and the nucleus in the relative motion. The result is the same quantum conditions as in eqn. (6) of this section but with μ instead of m . Consequently μ also takes the place of m in the expression for the energy.

The result of this for the spectral formula is that $R_{H\beta}$, $R_{H\gamma}$, etc., take the place of R_{∞} , whereby these symbols have the same meaning as in eqns. (9), (10), (11) of § 4. We may conveniently refrain from carrying out the calculations here sketched. Perhaps we may finally make two observations regarding the method of calculation.

The above treatment of Kepler's problem was kept as elementary as possible. But by using the methods of higher mechanics in our discussion of the same problem in Note 8 at the end of the book, we shall not only reduce the amount of calculation but also gain in precision. For we shall be able to present points of views to show that the polar co-ordinates here used are prescribed by the very nature of the problem and thereby give an answer to the question which was raised in § 1 of this chapter on page 201. The method that is to be developed later is unquestionably superior to that used in this paragraph. Moreover, the method of treatment of this paragraph cannot quite escape the reproach that it leaves a certain gap in not giving reasons for the choice of co-ordinates. Nevertheless it was inevitable that we should begin with the visual methods of this section; they form the proper introduction to the more abstract method of Note 8.

Our second remark, too, concerns a certain gap in the preceding representation. For Kepler's problem belongs to those exceptional cases of which we spoke on page 200; it is a so-called *degenerate problem*. The *external* characteristic of a degenerate problem consists in the circumstance that in it the choice of co-ordinates is not unique and that, therefore, the quantum conditions, too, that depend on the choice of co-ordinates, may be applied in various ways. In the case of our Kepler problem, the so-called parabolic co-ordinates that we shall use in § 4 of the next chapter, are in principle admissible as well as polar co-ordinates. By making use of these parabolic co-ordinates we should get quantised ellipses selected from the group of Kepler orbits different from those which we get when polar co-ordinates are used. The justification for favouring the latter is offered only when we have performed a passage to a limit, namely, by treating our problem first according to the laws of relativistic mechanics (cf. § 2 of Chap. VIII) and then, by neglecting the relativistic variability of mass, passing over to classical mechanics. The result obtained in this circuitous way agrees exactly with the result of our above treatment. On the other hand, the internal criterion for the degeneration of a problem consists in this, that, to fix the energy and hence also to obtain sharp spectral lines, fewer quantum numbers are necessary than there are degrees of freedom involved in the problem. We have already characterised degenerate systems in this way on page 200. In our case the quantum numbers n and n' do not actually enter into the expression (20) for the energy individually, but only the quantum sum $n + n'$. Thus, from the view of quanta, our problem has, so to speak, not two, but *one* degree of freedom.

From the point of view of his own principles, Bohr* accordingly denies that both conditions (6) are necessary for the treatment of the non-relativistic Kepler problem. We must of course admit that this view is incontestable, but, on the other hand, we can point to the fact that, from the physical point of view, our problem is to be regarded only as the limiting case of the non-degenerate relativistic problem, in which both quantum conditions, the azimuthal and the radial condition, come fully into their own.

§ 7. Quantising of the Spatial Position of Kepler Orbits. Theory of the Magneton

In the preceding section we quantised the Kepler orbits with respect to **size** and **form**, by means of the azimuthal quantum number n and the radial quantum number n' . We wish to show that the quanta can perform still more: they also determine the **position of the orbits in space**, that is, they select from the continuous manifold of all possible positions of the orbits in space a discrete number of orbits that conform with certain quantum conditions.

It is possible to quantise spatially only, of course, when a certain

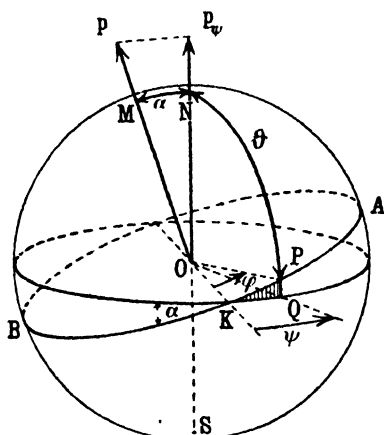

FIG. 73.

favoured direction is given with respect to which we may measure the orientation of the orbits. Such a favoured direction may be given either by an external field of force or by an internal atomic field. The first case is simpler and will be considered here. But in this case, too, we have no longer, even for the hydrogen atom, pure Kepler orbits. Rather, these are deformed through the external field of force. If we wish to manage with the Kepler orbits, notwithstanding this, we must pass on to the "limit when the force tends to zero." In this passage to the

limit, on the one hand the disturbance of the orbits by the field of force vanishes, but on the other hand the possibility of their orientation with respect to the field of force remains. The reason for this is that, whereas the disturbance of the orbits is a phenomenon which varies *continuously* with the field of force, the orientation of the orbits is restricted to certain *discrete* possibilities. That is why the latter remains after the passage to the limit, whereas the former vanishes.

* Cf., for example, what he says on page xv of his introduction to his collected essays on atomic structure, published in German by Vieweg & Son, Braunschweig, 1921.

We take the direction of the lines of force as the axis of a spatial polar co-ordinate system $r\theta\psi$; in Fig. 73 this is the axis SN. We assume the nucleus to be at rest in O; we draw the unit sphere (i.e. one of unit radius) about O as centre. Let the variable radius OP point to the present position of the electron. Let OK be called the common line ("Knotenlinie"); it is the line of intersection of the equatorial plane OKQ and the orbital plane OKP. The great circle KPAB is the trace of the orbital plane on the unit sphere. The "latitude" θ is represented in the figure by PN, the longitude ψ , reckoned from the common line, is represented by KQ; in addition, we consider the "orbital azimuth" ϕ , which is given by KP. Let α be the angle between the direction ON of the lines of force and the normals OM to the orbital plane; α appears in the figure as the arc MN, and at the same time as the angle at K in the spherical triangle KQP, which is shaded in the figure.

Corresponding to our three degrees of freedom $r\theta\psi$, we have now three quantum conditions:

$$\int p_r dr = n_1 h; \quad \int p_\psi d\psi = n_2 h; \quad \int p_\theta d\theta = n_3 h \quad (1)$$

The integration with respect to ψ is from 0 to 2π . The integration for θ stretches (cf. p. 201) from $\theta_{min} = NA$ beyond $\theta_{max} = NB$ back to θ_{min} ; the integration for r is as formerly (cf. p. 201) from r_{min} over r_{max} back to r_{min} . Thus the radial quantum integral is not different from that in the two-dimensional point of view. As in the preceding section, eqn. (14), it gives us:

$$2\pi p \left(\frac{1}{\sqrt{1-\epsilon^2}} - 1 \right) = n_1 h \quad (2)$$

and determines as before, through the eccentricity ϵ , the form of the orbit. p is the areal constant for the orbital azimuth ϕ . The corresponding quantum condition is:

$$\int_0^{2\pi} p d\phi = 2\pi p = n_2 h \quad (3)$$

Let n be called as before, the **azimuthal quantum number**; as a means of distinguishing n_1 , let it be called the **equatorial quantum number**. We now assert that the azimuthal quantum number is equal to the sum of the "equatorial" number n_1 and the "latitudinal" quantum number n_2 :

$$n = n_1 + n_2 \quad (4)$$

The proof is contained in the definition of p , p_ψ , and p_θ . In general the following holds (cf. eqn. (5), § 1 of this chapter) for any arbitrary co-ordinates qp :

$$p = \frac{\partial E_{kin}}{\partial \dot{q}}, \quad E_{kin} = \frac{1}{2} \sum^{(k)} p^k \dot{q}_k$$

The latter holds because E_{kin} is a homogeneous quadratic form of the \dot{q} 's (cf. also Note 4, eqn. (5)). In our case this yields, according as we use plane polar co-ordinates $r\phi$, or spatial polar co-ordinates $r\theta\psi$:

$$E_{kin} = \frac{1}{2}(p_r\dot{r} + p_\phi\dot{\phi}) = \frac{1}{2}(p_r\dot{r} + p_\theta\dot{\theta} + p_\psi\dot{\psi}).$$

From this it follows:

$$p_\phi = p_\theta\dot{\theta} + p_\psi\dot{\psi}$$

or, integrated with respect to the time for the whole duration of a complete period:

$$\int p d\phi = \int p_\theta d\theta + \int p_\psi d\psi \quad . \quad . \quad . \quad (5)$$

The integrals here indicated are our phase-integrals of eqns. (3) and (1); their values are, in turn, $n\hbar$, $n_1\hbar$, and $n_2\hbar$. Thus eqn. (5) is identical with eqn. (4).

But between the quantum numbers n and n_1 there is also the relation

$$n_1 = n \cos \alpha \quad . \quad . \quad . \quad . \quad (6)$$

For p is the whole moment of momentum of the rotating electron; p_ψ is its component in the equatorial plane. The former is, in Fig. 73, drawn as the vector in the direction of the normal OM to the orbital plane, the latter as the normal ON to the equatorial plane. As Fig. 73 shows: we have

$$p_\psi = p \cos \alpha \quad . \quad . \quad . \quad . \quad (7)$$

According to this, p_ψ , just like p , is constant during the motion. The equatorial quantum condition (1) becomes on calculation

$$2\pi p_\psi = n_1\hbar \quad . \quad . \quad . \quad . \quad (8)$$

In virtue of this equation and of eqn. (3), (7) is shown to be identical with (6).

Eqn. (6) already contains the remarkable result *that there are certain quantum favoured spatial positions of the orbital plane characterised by integral numbers*. Combined with eqn. (4) it states:

$$\cos \alpha = \frac{n_1}{n_1 + n_2}, \quad n_1 + n_2 = n \quad . \quad . \quad . \quad (9)$$

We consider in turn the cases $n = 1, 2, 3, \dots$ and represent them by the Figs. 74A, B, C. In them, the direction of the lines of force is, as in the preceding figure, supposed to run from the top to the bottom. The sense of rotation in the orbital plane is arbitrary, but is to be considered the same in each part of Fig. 74.

$n = 1$. In this case there are, according to eqns. (4) and (9), only *two possibilities*:

$n_1 = 1$	$n_2 = 0$	$\cos \alpha = 1$
and	$n_1 = 0$	$n_2 = 1$
		$\cos \alpha = 0$

Hence the orbital plane is either the equatorial plane ($a = 0$) or a meridian plane through the direction of the lines of force ($a = \pi/2$). Fig. 74A exhibits sections of both planes.

$n = 2$. According to eqns. (4) and (9) we have here **three possibilities**:

$n_1 = 2$	$n_2 = 0$	$\cos a = 1$
$n_1 = 1$	$n_2 = 1$	$\cos a = \frac{1}{2}$
$n_1 = 0$	$n_2 = 2$	$\cos a = 0$

Besides the equatorial plane ($a = 0$) and the meridian plane ($a = \pi/2$), there is a third possible inclination of the orbital plane, namely, that making an angle of 60° with the equatorial plane ($a = \pi/3$). Fig. 74B shows those three positions in section. The orbital plane, inclined at 60° , can of course be rotated arbitrarily about the direction of the lines of force; in the figure this is indicated by drawing the optical image of the one plane.

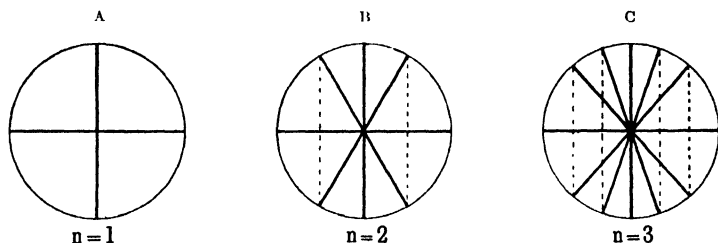

FIG. 74.

$n = 3$. Here there are *four possibilities*:

$n_1 = 3$	$n_2 = 0$	$\cos a = 1$
$n_1 = 2$	$n_2 = 1$	$\cos a = \frac{2}{3}$
$n_1 = 1$	$n_2 = 2$	$\cos a = \frac{1}{3}$
$n_1 = 0$	$n_2 = 3$	$\cos a = 0$

These four positions of the orbital plane may be constructed, as has been done in Fig. 74c, by dividing the radius into three equal parts. The positions corresponding to the values $\cos a = \frac{2}{3}$ and $\cos a = \frac{1}{3}$ have been drawn twice, to indicate that the corresponding orbital planes may be rotated about the direction of the lines of force.

So the process continues. In each of these orbital planes in space the electron may clearly describe, besides the circular orbit indicated by n , a series of elliptic orbits; for example, in the case $n = 3$, it may describe, besides the circular orbit $n = 3, n' = 0$, also the elliptic orbits $n = 3, n' = 1$; $n = 3, n' = 2$; $n = 3, n' = 3, \dots$. In the order of sequence of Fig. 72, these are orbits, each of which is represented by a different picture among those given; the circular orbit is represented by Fig. 72c; the first elliptic orbit by the ellipse of Fig. 72d that has the smallest eccentricity, and so forth.

Without doubt this spatial quantising is one of the most surprising results of the quantum theory. When we consider the simplicity with which the positions are derived and how simple is the result, it seems almost like magic.

Spatial quantising, as long as we stop at the limiting case of the external force tending to zero, has of course no effect on the calculation of the energy of the orbits and the spectral consequences following therefrom. The two quantum numbers n_1 and n_2 then enter into the expression for the energy only in the form of the sum: $n = n_1 + n_2$; that is, the expression for the energy and the spectral frequencies that are to be derived from it remain the same as in the case of simple quantising in the plane.

It is in connexion with this that the spatial Kepler problem is one degree more "degenerate" than the plane Kepler problem. Whereas we describe it mechanically by three co-ordinates as a problem involving three degrees of freedom and determine it, according to quantum considerations, by three quantum conditions, only the quantum sum $n_1 + n_2 + n'$ occurs in the expression for the energy. The necessity of using three quantum conditions may therefore be disputed (cf. the conclusion of the last section). But if we pass on from the case "in the limit the force tends to zero," to a true field of force, the degenerate character is eliminated and the existence of three quantum conditions becomes essential.

In carrying out the latter transition, we get at the same time a correction of the spatial possibilities enumerated above: in each case the number is to be reduced by one, since, in each case, the last position in our enumeration, the meridian position characterised by $n_1 = 0$, $\cos a = 0$, drops out. The reason is similar to that which in the previous section led us to declare as fictitious the ellipses that had degenerated to a double straight line (dotted in Fig. 71). Just as in the case of the degenerate ellipses the electron would collide with the nucleus, so we may show that in the meridian position of the orbital plane the electron, *under the influence of an electric force acting in this plane*, would finally approach infinitely near the nucleus. We cannot furnish the proof before § 5 of the next chapter, when we deal with the Stark effect, and when we generalise it for forces other than electrical forces in § 7 of the same chapter, in speaking of the *Adiabatic Hypothesis*. But we must take the result, which also holds for the case "in the limit the force tends to zero," for granted here, to correct our above enumeration of the possible orbits in space, which we now state as follows:—

For any arbitrary azimuthal quantum number n there are exactly n quantised positions of the orbital plane which are characterised by whole numbers. They correspond to all resolutions of the number n into $n_1 + n_2$, including $n_2 = 0$ (the equatorial position of the orbital plane), and excluding $n_1 = 0$ (the meridian position). These n positions are constructed by dividing

a radius of the equator of the unit sphere into n equal parts and erecting on the dividing points (excluding the centre of the unit sphere) right-angled triangles according to the example given in Fig. 74. These figures themselves are to be corrected by removing the diameter which is at right angles to the equatorial plane from the series of the projections of the orbital planes.

From this point of view we next return again to Fig. 71 of the previous paragraph. Each part of it was drawn for a given quantum sum $s = n + n'$, and consisted of s orbits, namely, a circular orbit ($n = s, n' = 0$) and $s - 1$ elliptic orbits ($n = s - 1, n' = 1; n = s - 2, n' = 2; n = s - 3, n' = 3$, respectively, and so forth). By now adding the spatial position of the orbits and taking into account the above theorem, we see that each of these orbits may in their turn be produced in as many ways as the numerical value of their azimuthal quantum number n ; that is, the circular orbit may be produced in s different ways, the first elliptic orbit in $s - 1$ ways, the second in $s - 2$ ways, and so forth. Owing to the lack of detailed knowledge, we regard all these spatial modes of generation as equally probable and as occurring equally often empirically; we thus arrive at the conclusion that the probability of the circular orbit to that of the first, second, . . . elliptic orbit is as

$$s : s - 1 : s - 2 : \dots : 2 : 1 \quad . \quad . \quad . \quad (10)$$

We call this probability the “*a priori* probability.” We hereby assume as in this whole section the presence of some direction of force or of orientation in space, but on the other hand we assume that the force that is present in no wise essentially affects the character of the Kepler orbits.

Our “*a priori* probability” will later give us a certain support in dealing with the difficult question of the intensity of spectral lines. Even now, however, it may already be remarked that this does not suffice to settle the question finally, but that the “probability of transition” between the initial and the final orbit plays an essential part in it.

To conclude this chapter we shall briefly consider a very important but as yet very obscure problem of physics on which the spatial quantising of electronic orbits promises to throw light, the problem of the **magneton**.

The view that every paramagnetic substance (i.e. susceptibility > 0) has a definite magnetic molecular moment is old established among physicists. It was elaborated in particular by Wilhelm Weber, and was rendered certain by Langevin’s theory of the dependence of paramagnetism on temperature. Within the last decades P. Weiss* has set out to prove by means of a great number of detailed measurements that this

* Summaries are given by P. Weiss, *Physikal. Zeitschr.*, **12**, 935 (1911), or *Verh. d. D. Phys. Ges.*, **13**, 718 (1911); R. H. Weber, *Jahrbuch für Rad. u. Elektr.*, **12**, 74 (1915); B. Cabrera, *J. de Chimie Physique (Guye)*, **16**, 442 (1918).

moment occurs not as an arbitrary quantity but as a whole multiple of a certain elementary moment. The value of this elementary moment, the "magneton" is, according to him:

$$M = 1123.5 \text{ gauss} \times \text{cm. per mol} \quad (11)$$

The value of the elementary moment of the individual atom or, in the case of compounds, of the individual molecule is obtained by dividing (11) by Loschmidt's number, $L = 6.07 \cdot 10^{23}$, and is:

$$\mu = \frac{1123.5}{L} = 1.85 \cdot 10^{-21} \text{ gauss} \times \text{cm.}$$

The assumption immediately forced itself on physicists that this elementary magnetic quantum was no new constant but was probably connected with the elementary electric quantum e and the quantum of action h . Let us endeavour to find this connexion as simply as possible.

As we know, a magnetic moment is equivalent to an electric current: Weber's electromagnetic measure of current in C.G.S. units depends just on the fact that the current strength times the enclosed surface around which the current flows is equal to the moment of the elementary magnet, placed at right angles to the current surface, that produces, at a great distance, the same magnetic field as the current. Let the current be a circular current of radius a and let it be produced by the revolution of an electron about the atom. If ω is the angular velocity of the electron, then $\omega/2\pi$ is its number of revolutions per second and $\frac{e\omega}{2\pi}$ is the current strength, calculated as the quantity of electricity that passes through the cross-section per second. Hence the magnetic moment μ of our circular current, calculated from the intensity of current and the circular surface:

$$\mu = \frac{e\omega}{2\pi} \pi a^2 = \frac{e}{2} \omega a^2 \quad (12)$$

Our rotating electron is a **rotator**. Its moment of momentum is determined on the quantum theory by the condition

$$m\omega a^2 = \frac{nh}{2\pi} \quad (13)$$

Hence the mechanical moment of momentum and the magnetic moment are expressed by ω and a in the same way and their ratio to one other is a universal constant. From magnetic measurements we can arrive at the mechanical moment of momentum and its value according to the quantum theory. Just as there is an elementary quantum of mechanical moment of momentum, so there exists theoretically an elementary quantum of magnetic moment.

From (12) and (13) there follows

$$\mu = \frac{e}{m} \frac{nh}{4\pi}$$

The theoretical elementary quantum of magnetic moment is, therefore,

$$\mu = \frac{e}{m} \frac{h}{4\pi}$$

or, referred to the mol (or gramme-atom, respectively)

$$M = \frac{e}{m} \frac{h}{4\pi} L \dots \dots \dots (14)$$

that is, if we insert the known values of e/m , h , and L :

$$M = 5584 \text{ gauss} \times \text{cm} \dots \dots \dots (15)$$

that is almost exactly five times as great as Weiss' magneton (11). We shall call the value (15) the **Bohr magneton**.

Now, how does it happen that Weiss appears to get the smaller unit in his measurements? What value is to be attached in particular to the methods of calculation by which he obtains the value (11)? We accept as the answer to this question an investigation by W. Pauli, jr., which we shall now describe.*

Concerning solid paramagnetic substances first, we must, in interpreting the measurements in question—at all events—take into consideration their crystalline structure. The same applies to ferromagnetic substances, all of which occur only in the crystalline or micro-crystalline form. Whereas Weiss assumes that, in the state of saturation, all atomic magnets point in the same direction, the crystal structure would seem to favour a distribution of these directions among directions prescribed by the symmetry of the crystal.

In the case of paramagnetic liquids, too, the theoretical interpretation is rendered difficult by the complicated character of the liquid state and by the question as to how the diamagnetism of the solvent is to be taken into consideration. In this case there is to be added that the magneton numbers determined by Weiss are by no means exact multiples of his fundamental unit.

There then remain the *paramagnetic gases*, of which measurements have hitherto been possible only for the cases O_2 and NO . In this case Langevin's theory of paramagnetism seems to ensure a trustworthy calculation of the magnetic moment to be ascribed to the individual gas molecule. Langevin's theory asserts that the Curie constant C , that is, the product of the absolute temperature and the susceptibility calculated for a mol of the gas, is given † by:

$$C = \frac{M^2}{R} \cos^2\theta \dots \dots \dots (16)$$

M is the magnetic moment of the mol; that is, L times the magnetic moment μ of the individual gas molecule; R is the gas constant referred

* W. Pauli, *Quantentheorie und Magneton*, Physikal. Zeitschr., **21**, 615 (1920).

† Cf., for example, M. Abraham, *Theorie der Elektrizität*, Bd. 2, 4, Aufl., § 31, p. 263.

to a mol ; θ denotes the inclination of the magnetic axis of a gas molecule to the direction of the magnetic field ; the horizontal bar drawn above the expression denotes that the average is taken for all angles of inclination.

Of course, before the advent of the quantum theory, Langevin's theory assumed θ to be continuously variable. By treating, in addition, all positions as equally probable (it is admissible to disregard favouring the direction of the magnetic lines of force in the process of adjustment, since it requires only a correction that is proportional to the intensity of field), the theory set

$$\overline{\cos^2 \theta} = \frac{1}{3} \quad . \quad . \quad . \quad . \quad . \quad (17)$$

that is, made it just as great for the direction of the lines of force as for two axes perpendicular to this direction. *But, from the point of view of spatial quantising, this is no longer admissible.* Rather, we now have :---

For $n = 1$. All orbits place themselves at right angles to the direction of the lines of force, cf. Fig. 74A ; we have excluded the other theoretical possibility, the meridian position of the orbital plane. Hence, for all orbits $\cos \theta = 1$, and therefore

$$\overline{\cos^2 \theta} = 1 \quad . \quad . \quad . \quad . \quad . \quad (17a)$$

For $n = 2$. The orbital planes set themselves partly at right angles and partly at angles of 30° to the lines of force ; cf. Fig. 74B. Either $\cos \theta = 1$ or $\cos \theta = \frac{1}{2}$; the theoretical possibility $\cos \theta = 0$ is again to be excluded. As on page 247 we regard both these possibilities as equally probable. Consequently,

$$\overline{\cos^2 \theta} = \frac{1}{2} [1 + (\frac{1}{2})^2] = \frac{5}{8} \quad . \quad . \quad . \quad (17b)$$

For $n = 3$. There are three and only three cases, namely, $\cos \theta = 1$, $\cos \theta = \frac{1}{3}$, $\cos \theta = \frac{2}{3}$; all three are equally probable. Accordingly

$$\overline{\cos^2 \theta} = \frac{1}{3} [1 + (\frac{1}{3})^2 + (\frac{2}{3})^2] = \frac{14}{27} \quad . \quad . \quad . \quad (17c)$$

In general. For the quantum number n , we have n equally probable positions, and we get

$$\overline{\cos^2 \theta} = \frac{1}{n} \left[1 + \binom{1}{n}^2 + \binom{2}{n}^2 + \dots + \binom{n-1}{n}^2 \right] \quad (17d)$$

$$= \frac{1}{3} \frac{(n+1)(2n+1)}{2n^2}$$

Equal distribution (equi-partition) among all directions, in the manner assumed by Langevin's formula (17), comes about, then, only in the limit when $n \rightarrow \infty$, as was to be foreseen. But this circumstance has a considerable influence on the calculation of the value of the magneton. As a matter of fact, Weiss bases his determinations of M along the reasoning of Langevin on the following formula which arises from (16) and (17)

$$M = \sqrt{3}RC \quad . \quad . \quad . \quad . \quad . \quad (18)$$

Taking into consideration spatial quantising, he should base them on the formulæ :

$$\text{In the case } n = 1 \text{ [eqn. (16) and (17a)] } M = \sqrt{RC} \quad . \quad (18a)$$

$$\text{In the case } n = 2 \text{ [eqn. (16) and (17b)] } M = \sqrt{\frac{2}{3}}RC \quad . \quad (18b)$$

and so forth.

In the case $n = 1$, for which the magnetic moment amounts to 1 Bohr, that is 5 Weiss, magnetons, Weiss would obtain a value according to eqn. (18) that is $\sqrt{3}$ times too great, namely :

$$5\sqrt{3} = 8.7 \text{ instead of } 5 \text{ Weiss magnetons} \quad . \quad (19a)$$

In the case $n = 2$, for which the magnetic moment amounts to 2 Bohr and hence 10 Weiss magnetons, a comparison of (18) and (18b) shows that Weiss' method of calculation leads to a value that is too great in the proportion $\sqrt{3} : \sqrt{\frac{2}{3}}$, thus

$$10\sqrt{\frac{1.5}{2}} = 13.7 \text{ instead of } 10 \text{ Weiss magnetons} \quad . \quad (19b)$$

Thus if we calculate by Weiss' method, not taking into account the position of the magnetic orbits of rotation, we cannot obtain integral multiples of magnetons, whether we use the Bohr or the (five times too small) Weiss unit. Actually, observations seem to show, too, that the integral character affirmed by Weiss is not in general true.

In the case of the gases NO and O₂, the number of magnetons* amounts, according to Weiss, Piccard and Bauer, to 9 and 14 (more recent measurements have given the values 9.2 and 13.9 or 14.2). It is worthy of note that these values lie in the neighbourhood of our numbers 8.7 and 13.7 in (19a) and (19b). We are therefore inclined to surmise that, in the case of these two very simple paramagnetic gases, we are dealing with the two simplest cases of *one* and *two Bohr magnetons*, whereby each O-atom, in NO as well as in O₂, would have one Bohr magneton. We do not wish to assert that in the case of these gases our numbers 8.7 and 13.7 should be accurately true, that is, that measurements free from error, when inserted in the Weiss-Langevin formula, should lead exactly to the values 8.7 and 13.7. Our spatial quantising refers in the first place to the orbits of the *hydrogen atom*; it may, indeed, be straightway applied to *other monatomic gases*, whereby the so-called **invariable plane**, that is, the plane of the total resultant moment of momentum takes the place of the orbital plane. But the application to diatomic gases is very doubtful. The molecular models of such gases are entirely unknown to us; according to their geometric structure, the spatial quantising may come out differently from that of the hydrogen atom, and then the energy of rotation may affect its orbital positions variously. When we just now concluded from the approximate number

* Weiss and Piccard, *Compt. rend.*, **155**, 1234 (1912); **157**, 916 (1913); Bauer and Piccard, *Journ. de Phys.*, 1920, p. 97.

of magnetons 9 and 14 that there were one and two Bohr magnetons, respectively, present, we did so under the assumption that the behaviour of diatomic gases, too, will not differ markedly from that of hydrogen and that here, too, the ideal case of hydrogen allows us to predict in general outline the approximate behaviour of the complicated cases. Moreover, we did so, in the conviction that the true unit is the Bohr magneton, not the Weiss magneton.

The object of the above discussion was clearly more negative than positive. We wished to show that up to the present measurements have not been able to contradict the quantum value (Bohr's) of the magneton, particularly not when it has been evaluated on the basis of Langevin's formula, which takes no account of spatial quantising. On the other hand, we could not adduce a certain *positive* contribution towards evaluating magnetic measurements either for crystalline paramagnetic solid, or paramagnetic gases. The natural conclusion that there is a Bohr magneton for every O-atom was fraught with uncertainty on account of our ignorance of the molecular models concerned. We have no doubt, however, that, some day, the abundance of magnetic observations will allow us to recognise unmistakably the existence of the Bohr magneton or, what amounts to the same, Planck's quantum of action and that it, just like the data of spectral observations, will bear striking testimony to the quantum structure of matter.

CHAPTER V

WAVE THEORY AND QUANTUM THEORY

§ 1. The Spherical Wave and its Propagation. Conservation of Energy and Momentum

H EINRICH HERTZ,* in his discourse at the Heidelberg Session of the Science Research Society (*Naturforschergesellschaft*) in 1889, drew certain general conclusions from his experiments on electric waves and made the following remarks about the nature of light :---

“What is light? Since the time of Young and Fresnel we know that it is a wave motion. We know the velocity of the waves, we know their lengths, and we know that they are transverse; in short, our knowledge of the geometrical conditions of the motion is complete. A doubt about these things is no longer possible; a refutation of these views is inconceivable to the physicist. The wave theory of light is, from the point of view of human beings, certainty.”

Has this certainty meanwhile been shattered? Yes and no! In all questions of **interference** and **diffraction**, the wave theory has not only maintained its position but has, indeed, gained new ground; it has extended its range of influence towards the side of small wave-lengths as far down as Rontgen and γ -rays, and towards the side of great wave-lengths as far as the waves of wireless telegraphy, whose length is measured in kilometres. In all questions, however, which, to use Einstein's language (cf. p. 38), concern the **production** and **transformation** of light, we have the firm conviction that the optics of the undulatory theory is, at least in its present form, insufficient. The appropriate and natural point of view to adopt towards these phenomena (photo-electricity, secondary radiation, absorption and excitation limits) is that of propagation not in spherical waves but in light-quanta $h\nu$, in the manner expressed by Einstein's photo-electric law. In these phenomena amounts of energy occur such as the wave theory simply cannot place at our disposal, not even if we enlist the help of an artificial accumulation of energy (p. 44). The mildest modification that must be applied to the wave theory is, therefore, that of disavowing the energy theorem for the single radiation phenomenon and allowing it to be valid only on the average for many processes. How this new type of localisation of

* *Gesammelte Werke*, 1, 340.

energy or this denial of every localisation of energy is to be brought into harmony with the laws of the electromagnetic field is still wrapt in obscurity. On the other hand, the most extreme view is that which regards the field laws themselves, that is, Maxwell's equations, only as statistical approximations and to consider the elementary phenomenon of individual emission as a continual succession of light-quanta, which have a definite direction. The connexion between these two views would then be similar to that in the gas theory, in which the continuous equation of state, is only a rough approximation, and the proper elementary process, however, by which the gas pressure is produced takes place discontinuously and in impulses. But whereas we have been able to carry out the statistical calculations for gas molecules and from it the continuous equation of state quite rigorously, we are still far from carrying out the corresponding statistical calculations for light-quanta. Only Einstein,* again, has succeeded in taking a first step in this direction, in deriving Planck's law of heat radiation by starting from elementary phenomena of a markedly one-sided and discontinuous character. The phenomena of light absorption and light transformation receive a natural interpretation in this theory; but the phenomena of interference and diffraction find no place in it. In particular, the spherical wave of optics becomes a configuration that is incoherent in itself, for it comes about as a result of averaging over elementary processes that are all independent of one another.

Both points of view, the classical continuous wave theory and the discontinuous-statistical theory of light-quanta, each offer at present only one-half of the truth. How the dilemma will be overcome finally, cannot yet be gauged. At all events the classical wave theory in its application to the phenomena of light propagation has not yet been supplanted by something better. It is, indeed, astonishing how much of the wave theory still remains even in spectroscopic processes of a decidedly quantum character. Bohr has formulated this very definitely in his *Principle of Correspondence* (cf. the end of § 3). For example, in describing the continuous radiation of X-rays, we pointed out the effectiveness of the classical wave theory (cf. p. 34).

In the sequel we shall take the view, as far as the propagation of light is concerned, of the classical wave theory. We shall thus repress all doubts about the idea of a spherical wave that is coherent in itself and shall accept it as given in experience. Whether this view is the fundamental and final one must be left an open question; it is at least approximately justified by a general correspondence between wave theory and quantum theory. To account for the *production* of light by the process of atomic radiation, on the other hand, we must absolutely call in the aid of the quantum theory, in particular Bohr's frequency law:

$$h\nu = W_a - W_e \quad \dots \quad (1)$$

* Verh. d. D. Phys. Ges., 1916, p. 318; Physikal. Zeitschr., 18, 121 (1917). See also p. 106 of *The Quantum Theory*, F. Reiche. Methuen & Co., Ltd.

This equation determines the *frequency* of the wave according to the theory of quanta. Besides frequency, however, a light wave possesses *intensity, polarisation, and a certain measure of coherence* (ability to interfere). The quantum theory seems at present unable to answer the finer questions touching the form of the vibrations, their arrangement in space and the space-time disposition of the train of waves. Here that is true, which may be said of every purely energetic treatment: the equating of energy—as is performed in our equation (1)—can never furnish more than *one* equation determining the course of the phenomenon. In the case of more than one degree of freedom the energetic view must be supplemented by a deeper dynamical treatment.

Let us next enumerate the determining factors, accessible to observation, of a monochromatic spherical wave (or one practically monochromatic) starting out from the point at which emitting atom is situated. The wave-length (or vibration number or frequency) is one determining factor, the length of the train of waves, the “coherence length” (number of successive wave-lengths up to the point of perceptible extinction of the phenomenon of “vibration”) is a second determining factor. (Strictly speaking, of course, a finite coherence length is not compatible with exact monochromatism; we here mean the kind of approximate monochromatism such as is presented by a sharp but, of course, not infinitely narrow spectral line.) *Three further determining factors* are presented by considerations of *intensity and polarisation*. For if we draw two mutually perpendicular planes through a direction of emission chosen at random, we have in both of them a definite amplitude of the alternating electromagnetic field and between both there is a certain phase difference of the partial vibrations. With these three data, the observable intensity and the character of the polarisation (linear, circular, or elliptic) is fixed for one direction. But it is not sufficient to furnish these data for any arbitrary direction of emission, but rather this direction must be a *unique axis for the spherical wave*, in order that through it the distribution of intensity and the polarisation is determined for the whole spherical wave.

At first sight it would appear that the existence of a unique axis contradicts the notion of a spherical wave. For a spherical wave is usually understood to mean a phenomenon that is propagated from the centre of the source of light symmetrically in all directions and in every respect. This view corresponds to our rough optical experiences but not to refined observation such as forms the basis of the theory of light. According to Maxwell's equations (as well as the older ideas of elasticity) a spherical wave has always a unique axis both for the distribution of intensity as for polarisation. Only the phase of the light is distributed with spherical symmetry; and only the wave surfaces, that is the surfaces of points in the same phase, in the case of a spherical wave, form a system of concentric spherical surfaces. On the other hand the surfaces of points of the same intensity are by no means spherical surfaces. Let us recall, for

example, the simplest case, in which, in the language of the classical wave theory a linearly vibrating electron emits the spherical wave. On account of the general character of transversality of the light vibrations no intensity is emitted in the direction of vibration of the electron; the intensity is a maximum at right angles to this direction (cf. in this connexion the innermost curve in Fig. 11, which depicts this case of emitted radiation). The surfaces of equal intensity have therefore by no means a spherical shape, but, rather, the direction of vibration of the electron is at the same time a *unique axis of the distribution of intensity*. The same is true in the case, which, in the language of the classical theory, corresponds to an electron that executes circular vibrations. Here the axis perpendicular to the vibration circle is a *unique axis of polarisation*, namely, the direction in which circular polarisation is observed, whereas in every direction inclined to this elliptic polarisation occurs, and in directions perpendicular to it, linear polarisation takes place. At the same time the axis mentioned is a *unique axis of distribution of intensity*. In this axis the intensity is a maximum, being, namely, twice as great as, for example, in the two directions at right angles to it.

Now, an axis that starts out from the centre of the sphere is defined by *two determining factors*, for example, two angular measurements. If we add to these the three determining factors which define the amplitude and the phase of the vibrations for this axis, and also the two first-mentioned data relating to frequency and coherence, we get in all: $2 + 3 + 2 = 7$ determining factors or elements of definition for the spherical wave. (We give quantitative details of this in Note 9.)

We require just as many equations of definition which will connect the light emission in the spherical wave with the changes of state in the emitting atom. Hereby we draw special attention to the following point: in general, according to the quantum view the atom and the "ether" are not connected with one another;* it is only during the process of emission that they are coupled together. In contradistinction to this, on the ordinary view of the wave theory, the electrons in the atom are permanently coupled with the ether: every change of motion of the electron produces wave radiation. According to this view we consider an electron active at the origin of every spherical wave, which generates in unison with the rhythm of its own motion the electromagnetic spherical wave. However convenient and however much accepted this view may be, yet we must free our minds of it. We must speak not of an electron but of a solution of Maxwell's equations, which is determined by conditions of coupling in the process of emission between the atom and the ether. The more abstract mode of expression, to which we are forced, is

*The objection has been raised against the account given here that in the stationary paths, too, the coupling between the atom and the ether cannot be entirely detached: both the inner forces acting between the nuclei and electrons, as well as the external forces of a possibly added electric or magnetic field are transmitted in the "ether." The author finds himself compelled to admit that this objection is justified.

inevitable if we wish to follow out logically the view of the quantum theory.

Let us now collect together the necessary conditions of coupling that may serve to determine the parameters of the spherical wave that enter into the solution.

In eqn. (1) we have so far only one such determining equation, or two, if we take into account that $h\nu$ determines not only the frequency but also the total energy of the spherical wave, that is, that eqn. (1) contains also a statement about the observable total intensity of each process of emission.

To arrive at further determining equations we consider, besides the energy, the **impulse** or **momentum** of the atom, on the one hand, and of the radiation on the other. In mechanics the fundamental law is that of the *conservation of momentum* (Galileo's and Newton's law of inertia), or, respectively, the law of change of momentum by external forces (Newton's second law). The law of conservation of energy is derived in mechanics as a consequence of the law of momentum.

In mechanics there follows, further, from the law of momentum the law of moment of momentum, in particular, the law of areas, which asserts the conservation of the moment of momentum for vanishing moments of the external forces. When, in the process of emission, the atom is coupled with the surrounding ether, we demanded by eqn. (1) the *conservation of energy*. The energy that is made available by the atom should be entirely accounted for in the energy of radiation ν , which is, according to the quantum theory of the oscillator, equal to $h\nu$. With the same right, we now demand the conservation of momentum and of the moment of momentum: *if in a change of configuration of the atom, its momentum or moment of momentum alters, then these quantities are to be reproduced entirely and unweakened in the momentum and moment of momentum of the radiation*. This postulate will furnish us with three further determining equations of the spherical wave.

The conservation of momentum and of moment of momentum holds hereby, as in mechanics, only when the atom is subject to no external forces. If the atom happens to be in an external field of force, this in general changes the momenta and reacts with them. The momenta may then, instead of being transferred to the radiation, be partly passed on to the external field of force. We show this in the third section.

To develop the equations in question—here for the case unencumbered by external forces—we must talk of momentum and moment of momentum of the atom, and then also of the momentum and moment of momentum of the “ether.”

The *momentum of the atom* does not mean the momentum of a single electron, which primarily brings about the emission of light through its change of motion, but the whole momentum of the atomic configuration.

In the case of hydrogen, too, with its one electron, we are concerned

not with the partial momentum of this electron, but with the whole momentum of the electron and the nucleus. This is zero, if the centre of gravity remains at rest while the electron rotates, no matter whether we regard the mass of the nucleus as finite and take into account the relative motion of the nucleus, or whether we consider the limiting case of an infinitely heavy nucleus at rest. The same is true for an atom containing any number of electrons moving in any manner: *on account of the law of the persistence of the centre of gravity, the total momentum of the atom is zero in its initial configuration; we assume that it is also zero in its final configuration, that is, that the atom does not, in emitting radiation, acquire a velocity as a whole due to a sort of rebound.* As a matter of fact there is no sufficient reason why the atom, when it emits a spherical wave, should favour one direction of velocity more than any other.* Hence *the change of momentum as the atom passes from the initial to the final configuration vanishes. No momentum is transferred from the atom to the ether.*

The position is, however, different in the case of the **moment of momentum**. We designated this for the single electron, for example, the hydrogen atom, by p (or p_ϕ since it is allocated to the azimuth ϕ of the rotation). In the case of the nucleus at rest, it was equal to $nh/2\pi$; when we took into consideration the relative motion of the nucleus we had to set the total moment of momentum of the electron + the nucleus equal to $nh/2\pi$ (cf. Chap. IV, § 4, eqn. (6), and also § 5, p. 227). But also in the case of a more general atomic structure, which we need not consider in further detail here, the resultant moment of the momenta of all masses (electrons + nucleus) is given by $nh/2\pi$, in so far as no external field acts on the atom and the law of areas therefore holds. Let n denote also in this general case, the "azimuthal quantum number."

Thus every change of the azimuthal quantum number n denotes a change of the moment of momentum. This amount of moment of momentum cannot be lost but must be transferred from the atom to the ether, if both systems are coupled together during the process of emission.

Before proceeding further, we shall interpose, as we have already done on page 215, a few remarks to excuse the use of the word "ether." From the point of view of the theory of relativity we must deny the reality of a universal ether transmitting light. No optical system is favoured more than any other. None may claim the true ether as its own. If, in the interests of a convenient and short terminology, we desire not to give up the term ether, we must allow every system of reference its own ether, which enjoys no preference above that of any other system. We hereby merely express that in every system of reference the propagation of light follows the same laws, namely,

* According to the point of view of the elementary processes with a definite direction (cf. p. 254), the position is different; according to Einstein the emitting atom must then suffer a rebound.

Maxwell's equations. This is true in particular of the system of reference in which the emitting atom is at rest. We need not think of a material substratum when we use the word ether; in our interpretation, the ether has no properties other than such as light itself possesses and such as arise out of the laws of the optical field.

Regarded from this angle, what interpretation are we to place on **the momentum of the ether** when we talk of radiation? Every one is aware of the fact that light has energy which, taken from the source of light, is radiated out with the velocity of light. Thus the conception of energy becomes extended from material systems to the electromagnetic system of the ether. The necessity of ascribing to the electromagnetic field not only energy but also momentum was pointed out by Lorentz and later by Poincaré* and Abraham.† We shall give two grounds for this necessity, one that is experimental, and one that is theoretical. The pressure of light may be regarded as an experimentally established fact. A ray of light that falls on an absorbing body exerts on it a pressure in the direction of the ray; a ray of light that is emitted by an emitting body exerts a reaction on the latter, like that of a cannon-ball on the cannon. The most striking theoretical evidence for the necessity of the conception of momentum in radiation is furnished by the relativistic law of the inertia of energy (cf. Chap. VIII, § 1). If energy has inertia and is equivalent to a certain mass, being equal to the energy divided by c^2 , the energy radiated out has momentum; the mass that is equivalent to the energy here moves with the velocity c , hence the momentum, being mass times velocity, is equal to the energy divided by c .

From this step we may conveniently arrive at the quantitative expression for the momentum of the radiation. The electromagnetic energy is, if measured in appropriate (so-called *rational*) units, per unit of volume,

$$W_1 = \frac{1}{2}\mathbf{E}^2 + \frac{1}{2}\mathbf{H}^2.$$

In the field of radiation \mathbf{E} is numerically equal to \mathbf{H} but perpendicular to it in direction, the direction of both being perpendicular to the direction of the ray. In place of W_1 we may, therefore, also write

$$W_1 = \mathbf{E}^2 = \mathbf{H}^2 = \mathbf{E}\mathbf{H}.$$

Let us denote the momentum, calculated for the unit of volume \mathbf{G} . According to the law of the inertia of energy, we have numerically

$$\mathbf{G} = \frac{W_1}{c} = \frac{\mathbf{E}\mathbf{H}}{c}.$$

The direction of the momentum is the same as that of the propagation of energy, that is the direction of the ray. We express this by writing

$$\mathbf{G} = \frac{[\mathbf{E}\mathbf{H}]}{c} = \frac{\mathbf{S}}{c^2} \dots \dots \dots (2)$$

* Arch. Néer., 5, 252 (1900) (Lorentz-Festschrift).
 † Ann. d. Phys., 10, 105 (1903).

In accordance with Note 1 at the end of the book [**EH**] the vector product of **E** and **H**, or **S**, is the so-called Poynting vector of energy-flux. By including (as in Note 1) the factor 4π in the denominator, we pass from our rational to the ordinary conventional units. Eqn. (2) is an expression of how closely connected momentum and radiation is, and likewise the momentum vector **G** and Poynting's vector **S**.

Hitherto we have spoken of the momentum in the single direction of the ray, and now we must consider the momentum of the whole wave. It is certain that the process of emission in the spherical wave is a spherically symmetrical process: in spite of the above-mentioned differences of intensity and polarisation within the spherical wave the radiation is in every radius equal and opposite to that in the corresponding diametral radius. *From this it follows that the total impulse of the spherical wave is zero, not only for unpolarised radiation but also for any arbitrary state of polarisation.* This result concurs with our above assumption that the atom, too, does not furnish the ether with momentum when they are coupled. Thus *the conservation of momentum imposes no other condition on the radiation produced than that it must be a spherically symmetrical spherical wave. The corresponding equation of condition is, so to speak, satisfied identically.*

The position is different, however, in the case of the *moment of momentum* of the spherical wave. The moment of momentum per unit volume of the ether is calculated as the product of the momentum **G** and the perpendicular from the centre of the spherical wave. It is most simply expressed analytically, both in magnitude and direction, by the vector product (cf. Note 1):

$$\mathbf{M} = [\mathbf{rG}] \quad . \quad . \quad . \quad . \quad . \quad . \quad . \quad . \quad . \quad . \quad (3)$$

where **r** is the radius vector from the centre to the unit volume under consideration. From the moment of momentum of unit volume we pass on to the moment of momentum that is radiated out in all directions in the spherical wave by forming

$$\mathbf{N} = \int dt \int d\sigma \mathbf{M} \quad . \quad . \quad . \quad . \quad . \quad . \quad . \quad . \quad . \quad . \quad (4)$$

in which the first integral is taken over the whole time of the emission, and the second over the whole spherical surface of radius *r*.

It certainly seems at first sight as if the moment **M** must vanish for each individual direction and hence also the total moment **N**. For if, as we said, **G** has the same direction as the ray and if this were the radial direction the perpendicular from the centre of the sphere to **G** would be zero and hence **M** would vanish. But we must notice that this determination of the direction of the ray and the momentum is only asymptotic and does not hold accurately for a finite **r**. Hence, in the integral (4), **M** differs from zero when **r** has finite values; when **r** increases towards infinite values, **M** does, indeed, decrease to zero but at the same

time the region of integration increases in proportion to the square of the radius of the sphere. This allows us to understand that both influences may compensate one another and that, in the limit for infinitely great distances, as well as for finite distances, \mathbf{N} may have a finite value. Thus *the total moment of momentum of the spherical wave is in general not equal to zero but is finite in value. It is able to take up and keep the amount of moment of momentum furnished by the atom.*

The considerations here sketched already show that the calculation of the moment of momentum of the radiation renders necessary the carrying out of a more elaborate passage to the limit; we have done this in Note 9. The result is this: we calculate the moment of momentum \mathbf{N} , which is radiated out, from the emitted energy W and the vibration number ν , by means of the formula

$$\mathbf{N} = \frac{W}{2\pi\nu} \frac{2ab \sin \gamma}{a^2 + b^2} \quad (5)$$

To define a , b , and γ , we first remark that a moment of momentum has an axis and hence defines a plane that is perpendicular to it. The axis of the moment of momentum is identical with what we called above *the unique axis* of the spherical wave. If we represent the state of motion by a vector potential (designated by Π in Note 9), this vector potential may be resolved into two perpendicular components that are contained in the unique plane of the momentum. Then a and b denote the amplitudes of vibration of these two components of the vector potential, and γ is the phase difference between them; a , b , and γ define what is called in the usual wave theory the *vibration ellipse* of the exciting electron. Follow the usual terminology, we should call the unique plane of the moment of momentum the *vibration plane*. We must carefully note, however, that even if we adopt the convenient terms *vibration ellipse* (or *vibration circle*) and *vibration plane*, because we are familiar with them, we associate with them a different meaning from that in the wave theory. As already pointed out on page 256, we do not speak of an electron that describes the vibration ellipse and that circulates in the vibration plane; in our account, the vibration ellipse occurs only as a characteristic of the phenomenon of emission and the vibration plane occurs only as the favoured plane of this process or of the corresponding vector potential. This potential itself is calculated, not from the motion of an electron, but from the conditions of coupling of the atom and the ether.

How our view differs from the usual one based on the wave theory manifests itself, too, in the way in which we define the different special cases of polarisation. It is appropriate to our standpoint that we base this definition not on the particular forms of motion of a vibrating electron, but on the special values of the moment of momentum \mathbf{N} , which, according to our view, determines the phenomenon of radiation.

We thus state: the light is **linearly polarised** when the moment of

momentum \mathbf{N} vanishes. By (5) this occurs when either a or b or $\sin \gamma$ vanishes. The vibration ellipse then degenerates to a straight line, which has either the same direction as b (if $a = 0$) or of a (if $b = 0$) or of the one or the other diagonal of the rectangle ab (if $\sin \gamma = 0$). The straight line is the *axis of symmetry* of the spherical wave. Its position allows us to determine for each radius of the spherical wave the direction of the electric force and the observable plane of polarisation according to the rules of the wave theory.

The light is **circularly polarised** when the moment of momentum \mathbf{N} attains its maximum for a fixed intensity of the light ($a^2 + b^2$ remains fixed), the values of a , b , and γ being otherwise variable. This maximum occurs when $a = b$ and $\sin \gamma = +1$ (phase angle $\gamma = +\pi/2$); hereby, the factor depending on a , b , γ in (5) becomes equal to $+1$. The vibration ellipse becomes a vibration circle. Along the axis of the moment of momentum, we have the circularly polarised light, being *left* or *right* polarisation according as $\gamma = +\pi/2$, or $\gamma = -\pi/2$. In all other directions the light is polarised elliptically or, in particular, linearly (namely, perpendicularly to the axis of the moment of momentum).

By setting the moment of momentum, calculated in (5), of the radiation equal to the moment of momentum (by the principle of the conservation of the moment of momentum) which is placed at the disposal of the ether by the atom when the latter changes its configuration, and indeed, setting it equal both in direction and magnitude, we get three determining equations of the geometric character of the resultant emission. We thus get one equation by equating the magnitude, and two by equating the directions of the two moments of momentum. If one of the above-mentioned special cases occur, we also get a statement concerning the character of the polarisation. The complete determination of the defining factors enumerated in this section is, however, not yet hereby attained. Whereas we enumerated seven such elements above, we have here only five determining equations, namely, two in (1) and three in (5). Concerning the "coherence length" in particular, which we counted as one of the determining elements of the spherical wave, it has been proved by interference effects of light for great differences of path, that such a coherence length must exist and must have a perceptible size. Important evidence on this question is furnished by the quantitative measurements of the dying down ("*Abklingen*") of the luminescence of canal rays carried out by W. Wiess.* Whether we have from this to deduce the duration of luminescence of the individual elementary phenomena or rather the so-called "length of stay" ("*Verweilzeit*"), that is the time that the excited electron persists in its initial orbit, is still undecided.

The problem of determining fully the *elementary process* of emission has, indeed, been partially unravelled in the foregoing but it is not yet

* Ann. d. Phys., 60, 597 (1919).

fully solved; we may say that $\frac{5}{7}$ ths of it are solved and the remaining $\frac{2}{7}$ ths are still in darkness. But even if the whole seven of the determining elements were discovered, we should still have to investigate the *probability* of the elementary processes, which alone defines the observable intensity of the spectral lines. This is a statistical question which we touched on in Chapter IV, § 7, page 247, and shall consider more thoroughly in Note 10; the steps here enumerated disclose nothing on this subject.

In conclusion we shall point out those features in which our treatment and the classical wave theory agree and those in which they differ.

They agree in their views of the phenomena that occur in the ether. According to the wave theory, as well as ours, the ether vibrates, that is, it propagates alternating electromagnetic fields. We take over Maxwell's equations, which define the ether and regulate its vibrations, directly from the wave theory.

They differ in their views of the excitation of the states of vibration. According to the wave theory, the electron that excites the ether also vibrates. It is forcibly coupled with the ether and impresses its time of vibration on the latter, which, according to the wave theory, is prescribed by the nature of the bond between the electron and the atom. According to the view of the quantum theory, however, the coupling between the ether and the electron is less strong or more superficial. In its stationary orbits, the electron does not excite the ether at all, but is coupled to it only during the transition from one stationary orbit to another. The duration of vibration of the radiation has nothing to do with the revolution of the electron in its stationary paths. Even during the transition there is nothing in the atom that occurs in rhythm with the vibration number ν . The ether demands its $h\nu$, the atom furnishes it by giving up an amount of energy $W_n - W_m$. The duration of vibration follows if these two quantities are equated; at the same time, the polarisation follows if we equate the two corresponding moments of momentum. (It has, indeed, been suggested that the transition from the stationary initial orbit to the stationary final orbit takes place along a spiral, which is traversed with the frequency ν .) This too specialised picture seems to us unfruitful. *It is not the atom that vibrates, but the ether.* The coupling between the atom and the ether is, as we said, more provisional in the quantum theory than in the wave theory. The atom gives the ether a certain amount of energy and moment of momentum. The ether does with this, what its nature compels it to do, namely, it transforms these amounts into vibrations of a definite state of polarisation. The coupling is of an *integral* kind, not of a differential kind that determines the infinitesimal elements of the process of vibration.

Is this state of the theory only transitory, or does it denote an actual advantage of the quantum theory? A theory should, indeed, determine the observable phenomena, but must not over-determine them. There

are in the spherical wave, as we saw, only a definite number of determining elements or factors. Consequently a definite number of determining equations also suffices. Our integral equations of coupling for the energy and the moment of momentum do not, indeed, furnish a sufficient number of such equations. But they determine several essential factors of the ether vibration and allow the atom on the one side, and the ether on the other, the necessary freedom to behave in their appropriate manners, respectively, that is so that the atom suffers changes in stationary electronic orbits, and the ether undergoes vibrations. Of course, from the moment new empirical factors occur which do not fit into the scheme of the spherical wave with its finite numbers of parameters, effects such as one-sided emission or similar phenomena, the theory must at once give up its general standpoint and must adopt new and cautious hypotheses, also, for example, about the nature of the transition from the initial to the final orbit.

§ 2. Principle of Selection and Rule of Polarisation

In the preceding section we quoted the moment of momentum of the radiation of a spherical wave and we have derived it in Note 9. It was

$$\mathbf{N} = \frac{W}{2\pi\nu} \frac{2ab \sin \gamma}{a^2 + b^2} \quad \cdot \quad \cdot \quad \cdot \quad \cdot \quad \cdot \quad (1)$$

where W is the energy of the spherical wave; as we have to set the latter quantity equal to $h\nu$, we get

$$\mathbf{N} = \frac{h}{2\pi} \frac{2ab \sin \gamma}{a^2 + b^2} \quad \cdot \quad \cdot \quad \cdot \quad \cdot \quad \cdot \quad (2)$$

where a , b , and γ denote amplitudes of vibration and the phase difference of two mutually perpendicular directions in the plane which is at right angles to the axis of \mathbf{N} ("vibration plane"). Herein that which vibrates is not the atom nor an electron in the atom, but the electromagnetic field in the ether, which we described by means of a vector potential in Note 9.

The moment of momentum of the radiation must be equal to the change which the moment of momentum of the atom undergoes during the transition from its initial to its final configuration. The atom is a closed mechanical system in which only internal forces act. Consequently the law of sectorial areas holds for each of its stationary forms of motion; that is, the moment of momentum of the whole system remains constant during the motion; there is a so-called **invariable plane**, whose normal is the axis of the moment of momentum. As in the case of the hydrogen atom this total moment of momentum p is fixed in terms of whole numbers by the quantum condition of the rotator $2\pi p = nh$. Thus the change of the moment of momentum Δp is connected with the change Δn of the azimuthal quantum number by the equation

$$\Delta p = \frac{h}{2\pi} \Delta n \quad \cdot \quad \cdot \quad \cdot \quad \cdot \quad \cdot \quad (3)$$

By equating (2) and (3), it accordingly follows that

$$\Delta n = \frac{2ab \sin \gamma}{a^2 + b^2} \quad . \quad . \quad . \quad . \quad (4)$$

This equation holds with respect to both magnitude and direction.

The numerical value of the right-hand side of eqn. (4) is less than or at most as great as 1. We have actually, since $(a - b)^2 > 0$:

$$a^2 + b^2 > 2ab \quad . \quad . \quad . \quad . \quad (5)$$

so much the more is

$$a^2 + b^2 > 2ab \sin \gamma \quad . \quad . \quad . \quad . \quad (5a)$$

In place of this inequality we have the equality

$$a^2 + b^2 = \pm 2ab \sin \gamma \quad . \quad . \quad . \quad . \quad (5b)$$

only in the case $a = b$, and $\sin \gamma = \pm 1$, that is, $\gamma = \pm \pi/2$. In this particular case the right-hand side of (4) becomes equal to ± 1 . Hence the absolute value of the left-hand side of (4) is, at the most, equal to 1:

$$|\Delta n| \leq 1 \quad . \quad . \quad . \quad . \quad (6)$$

We first assume that the plane of the moment of momentum in the atom (the invariable plane) is the same before and after the transition. The vector p of the moment of momentum which is perpendicular to this plane has therefore the same direction before and after the transition. Its change Δp is equal to the algebraic difference of the two similarly directed vectors p_a and p_e . Just like Δp , Δn is calculated from the algebraic difference of the two integral quantum numbers n_a and n_e , and is thus itself also necessarily integral.

There are only three integers whose absolute value is not greater than 1, namely, the numbers

$$\Delta n = +1, \quad \Delta n = 0, \quad \Delta n = -1.$$

In the cases $\Delta n = \pm 1$, eqn. (5b) holds; the corresponding values of a , b , and γ are fully determined and already given by eqn. (5b). In the case $\Delta n = 0$, the numerator of the right-hand side must, by eqn. (4), vanish. From this it follows that we must have either $a = 0$, or $b = 0$, or $\sin \gamma = 0$ (i.e. $\gamma = 0$ or π).

For integral values of Δn we thus have three possibilities:

$$\Delta n = \begin{cases} +1 & a = b \text{ and } \gamma = +\pi/2 \\ 0 & a = 0 \text{ or } b = 0 \text{ or } \gamma = 0, \text{ i.e. } \pi = 0 \\ -1 & a = b \text{ and } \gamma = \pi/2. \end{cases} \quad . \quad (7)$$

According to the remarks on pages 261 and 262 of the previous paragraph the emitted light is *left-circularly* and *right-circularly* polarised respectively in the first and third cases, but *linearly polarised* in the second case.

In this way, by a remarkably rigorous process of deduction, reminiscent of the incontrovertable logic of numerical calculation, we have

arrived from the principle of the conservation of moment of momentum at a *principle of selection* and a *rule of polarisation*.

The principle of selection states: *the azimuthal quantum number can at the most alter only by one unit at a time in changes of configuration of the atom.*

The rule of polarisation demands that *if the azimuthal quantum number alters by ± 1 , the light is circularly polarised; if the quantum number remains constant, the light is linearly polarised.*

The principle of selection and the rule of polarisation, as well as the present method of deducing them are due to A. Rubinowicz.*

In the case of circular polarisation ($\Delta n = \pm 1$) there is a unique direction of the ray (normal to the vibration plane, axis of the moment of momentum in the ether) in which the polarisation appears circular, whereas in the gradually inclining directions of the ray it appears as more or less elliptic and finally linear. This unique axis of polarisation, too, is fixed by our argument. For eqn. (4) holds, as we said, not only as regards quantity but also as regards direction. On account of the equality of direction the axis of the moment of momentum \mathbf{N} , that is the axis of the circular polarisation must coincide with the normal to the invariable plane of the atom before and after the transition.

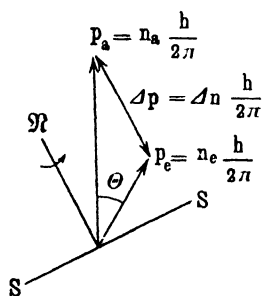

FIG. 75.

On the other hand, in the case of linear polarisation ($\Delta n = 0$) the direction of polarisation remains indeterminate; our determining eqn. (4) assumes the form $0 = 0$ and gives no clue about the direction. The conclusion which at once suggests itself, although it is not inevitable, that where the direction of polarisation is

thus indeterminate, nothing at all happens, that is *that the case $\Delta n = 0$ which could theoretically lead to linear polarisation can lead to no emission.*

Hitherto we have assumed that the moment of momentum p of the atom retains its axis during the change of configuration. We shall now make the more general assumption that this axis, and hence also the invariable plane of the atom (the orbital plane of the electron in the simple Kepler motions) changes. Then Δp is to be constructed vectorially from the moments of momentum p_a and p_e before and after the transition, as shown in Fig. 75. Let Θ be the angle between the axes of the two moments of momentum before and after the transition. By Pythagoras' theorem, we get

$$\Delta p = \sqrt{p_a^2 + p_e^2 - 2p_a p_e \cos \Theta}.$$

* *Bohrsche Frequenzbedingung und Erhaltung des Impulsmomentes*, Physikal. Zeitschr., **19**, 441 and 465 (1918).

Moreover, on account of the relationship between $p, \Delta p$ and $n, \Delta n$, expressed in the figure, we also have

$$\Delta n = \sqrt{n_a^2 + n_e^2 - 2n_a n_e \cos \Theta} \quad . \quad . \quad . \quad (8)$$

At the same time, in the triangle formed from p_a, p_e and Δp , the one side Δp is in general, according to Euclid, greater than the difference between the other two sides p_a and p_e , thus

$$\Delta p \geq |p_a - p_e|$$

for which, on account of the proportionality between p and n , we may also write

$$\Delta n \geq |n_a - n_e| \quad . \quad . \quad . \quad (9)$$

The sign of equality holds only when the triangle degenerates to a double straight line, that is $\Theta = 0$; this is the case which we have already considered, namely, in which p_a and p_e are in the same direction.

The axis of the moment of momentum \mathbf{N} of the spherical wave coincides with the direction of Δp , as is indicated in the figure. At the same time the vibration plane SS has been drawn in as a normal plane to this direction.

According to eqn. (6) we now have

$$\Delta n \leq 1 \quad . \quad . \quad . \quad (10)$$

and, by (9), still more is

$$|n_a - n_e| \leq 1 \quad . \quad . \quad . \quad (11)$$

Thus our *principle of selection* still holds exactly as before under the present general assumption, that is: *the azimuthal quantum number can change by at most one unit during a change of configuration.*

In the first and third cases, $n_a - n_e = +1$, we also have $\Delta n = 1$ owing to the following double equation, arising out of (9) and (10):

$$|n_a - n_e| \leq \Delta n \leq 1$$

hence we have, as remarked in the case of (9), $\Theta = 0$. The relative position of the vectors p_a and p_e is, therefore, actually not shown correctly in Fig. 75; rather, this figure degenerates into one in which p_a and p_e , Δp and \mathbf{N} all have the same direction. We then find ourselves again confronted with the conditions above considered and our *rule of polarisation* is also valid unchanged, that is: *the light is circularly polarised and the vibration plane coincides with the invariable plane before and after the transition.*

The position of things is not so simple in the second case $n_a - n_e = 0$, which is represented in Fig. 76. If we denote the common value of n_a and n_e by n , then, as a result of (8),

$$\Delta n = n \sqrt{2(1 - \cos \Theta)} = 2n \sin \Theta/2 \quad . \quad . \quad . \quad (12)$$

Hence from $n_a - n_e = 0$, it does *not* now follow that $\Delta n = 0$. In Fig. 76, the vector \mathbf{N} represents the axis of the moment of momentum of the spherical wave, which coincides with the direction of Δp . The corresponding plane of vibration SS is then the plane of symmetry between p_a and p_e . From (10) and (12), we see that half the angle between the directions of p_a and p_e is subject to the limitation

$$\sin \Theta/2 \leq \frac{1}{2n} \quad \dots \quad (13)$$

But we further wish to show that we now also return to the case initially considered in which p_a and p_e have the same direction, that is, in which the angle of inclination $\Theta = 0$. To do this we refer to the spatial quantising of the orbits, which was treated in the last section of the preceding chapter. As the spatial quantising could there be carried out only for Kepler paths, we shall here also speak only of the orbital plane of a single electron instead of the invariable plane of any arbitrary atomic system, but we shall finally allow ourselves to extend this result to the general case.

We certainly have not now, in conformity with our assumption, an

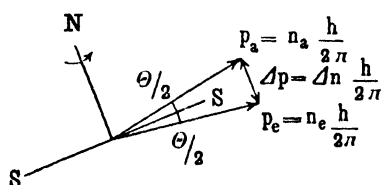

FIG. 76.

external field of force to which we may refer the orientation of the orbital plane. In the absence of such a field, we shall adopt the standpoint (certainly rather risky) that the initial position of the orbital plane already defines a favoured direction in space.

The normal of the initial orbit then takes the place of the direction of the lines of force, of which we spoke in Chapter IV, § 7, and the equation which formerly determined the inclination of the orbital plane to the field of force, now applies to the inclination of the final orbit to the initial orbit. By correspondingly replacing the former symbol α for the angle by Θ , and taking n_1, n_2 to denote the quantum numbers of the final orbit in its orientation with respect to the initial orbit, we may write the equation referred to thus:

$$\cos \Theta = 1 - 2 \sin^2 \frac{\Theta}{2} = \frac{n_1}{n_1 + n_2}, \quad n_1 + n_2 = n \quad \dots \quad (14)$$

From this, it follows

$$\sin^2 \frac{\Theta}{2} = \frac{n_2}{2n} \quad \dots \quad (15)$$

On the other hand, by eqn. (13):

$$\sin^2 \frac{\Theta}{2} \leq \frac{1}{4n^2} \quad \dots \quad (16)$$

From (15) and (16) it follows that:

$$\frac{n_2}{2n} \leq \frac{1}{4n^2} \quad n_2 \leq \frac{1}{2n}$$

Now $\frac{l}{2n}$ is a proper fraction, and n_2 is an integer. Hence the only value of n_2 that is possible under these conditions is $n_2 = 0$. But eqn. (14) then states that

$$\cos \Theta = 1, \quad \Theta = 0.$$

Thus the plane of the final orbit coincides with that of the initial orbit. Accordingly, the more general case in which p_a and p_e are in different directions reduces to the previous case in which they had the same direction, and this happens not only for changing quantum numbers $n_a - n_e = \pm 1$, but also for quantum numbers that remain equal, i.e. $n_a - n_e = 0$.

On the whole we have the remarkable result: *the invariable plane of the atomic planetary system (in the simplest Kepler case this is the orbital plane) remains the same (is "invariable") not only in the case of the stationary motions themselves, but also in the transitions from one such motion to another. If, in these transitions, the azimuthal quantum number changes by one unit, the light emitted is circularly polarised. If the azimuthal quantum number is to remain unaltered, only linear polarisation can occur; but since the direction of the latter is indeterminate, we conclude that such transitions are not connected with emission. The general case of elliptic polarisation is suppressed by the quantum conditions (if the spatial quantising is applied).*

In the whole of this section we have spoken solely of such transitions in the atom as may give rise to monochromatic emission. It is only for these that the preceding limitations and exclusions hold. Only when we assumed the coupling between the atom and the ether, did we arrive at our principle of selection and so forth, and only the combination of the two postulates that energy and moment of momentum are transferred to the ether, led to the eqn. (1) on page 264, from which we made our later inferences. Phenomena that have nothing to do with monochromatic wave radiation are not subject to the principle of selection. These include, for example, electronic impacts which throw an atom from its natural state into an excited state. In such a case we are dealing not with the combination, atom and ether, but with the combination, atom and impinging electron. Such occurrences have nothing to do with the principle of selection.

How far have we got with the experimental proof of these results?

It is evident that in an atom not subject to forces *the rule of polarisation* eludes experimental proof. In this case every position in space is of equal value with every other. Hence if the individual occurrence exhibits polarisation in conformity with the position of the atom, the observable total phenomena will still appear totally free from polarisation. This holds for hydrogen as well as for every other atom.

The position is more favourable as regards *the rule of selection*. In

the case of atoms other than hydrogen, it leads to important restrictions of the principle of combination, which we shall get to know in the next section, and thus finds clear expression in the general series scheme of these atoms. But in the case of the hydrogen spectrum, too, the rule of selection is accompanied by surprising consequences. The azimuthal quantum number n can change only into $n \mp 1$. Hence it follows that, for example, when H_β or H_γ are emitted, a circular orbit can never transform into a circular orbit. For H_β ($4 \rightarrow 2$) the initial orbit, if it takes the form of a circle, would have the azimuthal quantum number $n_u = 4$, the final orbit the azimuthal number $n_v = 2$. This transition cannot lead to an emission; the "ether" would not be able to take up the moment of momentum $\Delta n = 2$. Thus the initial orbit of H_β and likewise of H_γ , H_δ , . . . must be an elliptic orbit; only in the case of H_α ($3 \rightarrow 2$) can a circular orbit be transformed into a circular orbit. The final orbit in the cases H_α , H_β , . . . may be a circle, but need not be so. From this we see that the various possible origins, which we counted up on page 239, for Balmer's lines, are considerably reduced by the principle of selection, and that Fig. 67 on page 218, which makes a circular orbit pass into a circular orbit for all Balmer lines, is incorrect.

The possibility of proving the principle of selection experimentally is certainly as yet not offered as long as we maintain the standpoint adopted in the preceding chapter. From that standpoint all possible transitions coincide in one line and the differentiation between circular and elliptic orbits seems at first sight impossible. This is different, however, if we adopt the relativistic standpoint, as we shall do in the final chapter; in this case each transition corresponds to a different component of a *fine structure*, and then it also becomes possible to test the principle of selection quantitatively by spectroscopic experiments.

But the rule of polarisation and the principle of selection enter fully into action only when an external field of force is present, as in the Stark effect and the Zeeman effect. The next section is to serve as an introduction to these phenomena.

§ 3. Emission in a Field of Force. Principle of Correspondence

We assume the field of force to be an electric field. On account of the very small order of magnitude of atomic dimensions we may certainly regard it as homogeneous. Thus the force has everywhere the same magnitude and the same direction. We determine the moment of the force for a fixed point O of the atom, for example, for the nucleus situated at an arbitrary initial point P , and represent it by a vector (at right angles to the plane through O , P , and the direction of the lines of force). The component of this vector in the direction of the lines of force is then zero. According to mechanics, the moment of the force determines the change in the moment of momentum; the moment of momentum is here to be calculated as the sum of the moments of momentum of all the

particles of mass of the atom with respect to the same point O and is likewise to be represented by a vector. Its component in the direction of the lines of force now remains constant on account of the vanishing of the corresponding component of the moment of the force, whereas the perpendicular component in the plane continually changes. Thus the law of areas holds, in its special form as the law of the conservation of the sectorial velocity, only for the direction of the lines of force. It is only for this direction that we have an areal (sectorial) constant.

Consequently, we may demand the conservation of the moment of momentum during the coupling of the atom with the ether only for this special direction. This already allows us to see that we can assign to the components of the moment of momentum that are perpendicular to the lines of force no definite constant amounts that would be transferred from the atom to the ether during the process of emission. For these components change in the atom with the phase of the motion, and hence their difference in the initial and the final configuration would depend on that phase of the motion, in which we imagine the initial configuration to have ceased and the final configuration to have started. But in reality the process of emission must be definite and free from such arbitrariness. Hence we conclude that only the constant component of the moment of momentum in the direction of the force can determine the emission.

This component of the moment of momentum, and not the whole moment of momentum will now be equal to $nh/2\pi$, according to the quantum theory. Let n be called the **equatorial quantum number**. We take the direction of the lines of force as our z -axis, and the perpendicular xy -plane will be called the equatorial plane. Our present quantum number n refers to the circulatory motion in the equatorial plane and not as before to that in the invariable plane. Accordingly, let \mathbf{N}_z be the component, in the direction of the lines of force, of the moment of momentum of the emitted spherical wave. We take its mode of representation in terms of the amplitude and phase constants of the spherical wave from eqn. (23) of Note 9. Since we have now defined our coordinate system with reference to the field of force, and not, as before, with respect to the plane of vibration, three amplitude constants a, b, c , now occur, of which the third, c , refers to the z -axis, whereas in our former orientation with respect to the plane of vibration this third amplitude constant dropped out. Moreover, there occurs in the quoted eqn. (23) a phase constant γ , which denotes the phase difference between the a -vibration and the b -vibration (the x - and the y -component). Our representation of \mathbf{N}_z now becomes

$$\mathbf{N}_z = \frac{h}{2\pi} \frac{2ab \sin \gamma}{a^2 + b^2 + c^2} \dots \dots \dots (1)$$

This z -component of the moment of momentum of the ether must be

equal to the change in the corresponding component of the atomic moment of momentum. We thus demand that

$$\mathbf{N}_z = \frac{h}{2\pi} \Delta n \quad \dots \quad (2)$$

where Δn is the change in our present equatorial quantum number, that is, simply the algebraic difference between its initial value n_a and its final value n_s .

From (1) and (2) it follows that

$$\Delta n = \frac{2ab \sin \gamma}{a^2 + b^2 + c^2} \quad \dots \quad (3)$$

Just as in the previous section we may now conclude: the numerical value of the right-hand side of (3) is necessarily ≤ 1 , for, as in eqn. (5) on page 265,

$$a^2 + b^2 > 2ab$$

hence so much the more is

$$a^2 + b^2 + c^2 > 2ab \sin \gamma.$$

Thus the right-hand side of (3) can be equal to ± 1 only if simultaneously

$$a = b, \quad c = 0, \quad \sin \gamma = \pm 1.$$

Accordingly the left-hand side of (3) must necessarily lie between the limits ± 1 . As it is itself an integer, being the difference of two integers, it can have only the values

$$\Delta n = +1, 0, -1.$$

When $\Delta n = \pm 1$, we get

$$a = b, \quad c = 0, \quad \sin \gamma = \pm 1.$$

We have a **circularly polarised spherical wave** (left or right). *Its vibration plane is the equatorial plane* (perpendicular to the direction of the lines of force), *and its unique axis coincides with the direction of the force. The component of the vibration in the direction of the force, measured by the amplitude c , vanishes.* The vibration ellipse becomes a vibration circle that is perpendicular to the direction of the force.

When $\Delta n = 0$, we get, by (3), either $a = 0$, or $b = 0$, or $\sin \gamma = 0$. This suggests the conclusion that *only the z -component of the vector potential can be present*, that is, that both $a = 0$ and $b = 0$, whereas only $c \neq 0$. To determine this, we set up the following line of argument that is not, however, inevitable. The polarisation must be fully determined in this case as in every other. On account of the field of force the z -axis and the equatorial plane xy are uniquely determined, but within this plane every direction is of no less and no more value than any other. If $a = 0$ and $b = 0$, then the y -axis would be favoured as a direction of vibration as compared with the x -axis. If $b = 0$ and $a \neq 0$, the x -axis

would be favoured. If $\sin \gamma = 0$, we should have a linear vibration in the direction of the resultant of the two amplitude vectors a and b , and this direction would then be favoured above all other directions of the equatorial plane. There is no physical reason that this should be so. But the necessary equality of value (equivalence) of all equatorial directions is, however, brought about if we set $a = b = 0$, whereby the eqn. (3) is likewise satisfied for the case $\Delta n = 0$. Thus we are left with only the amplitude of vibration c , which is actually favoured by being in the direction of the lines of force. *The spherical wave produced is then linearly polarised and the direction of the force is the axis of symmetry of the linear polarisation.*

The difference in this result and in the mode of inference compared with the case in which there is no field of force (p. 267) is to be noted. In the latter case, the vibration vector (a, b) lay in the orbital plane (invariable plane) of the atom; in accordance with the definition there was no c component perpendicular to this plane. The equivalence of all directions within this plane therefore led to the conclusion: $a = b = c = 0$, that is to *no emission*. In the present case, on the other hand, the c -component is favoured by being in the direction of the lines of force. Our corresponding conclusion is here, therefore, $a = b = 0$, $c \neq 0$, that is, *linear polarisation along the z -axis*.

Moreover, whereas in the case in which no forces were present, we could prove that the *orbital plane* (or the invariable plane, respectively) was preserved during the transition from the initial to the final state, there is no question of this in the present case. Under the influence of an electric field the orbit of the hydrogen electron is not plane, and a more general type of atom has no invariable plane. But even under the influence of a magnetic field, in which we can, in a certain sense (cf. § 6) speak of a plane orbit of the hydrogen electron, *this plane is not preserved* in the transition.

Summing up, then, we may say that also in the presence of an external field of force the *rule of polarisation* and the *principle of selection* is confirmed provided the appropriate changes are introduced which are given by the existence of a unique direction of the force. *The rule of polarisation* states that the axis of symmetry of the linear or the unique axis of the circular polarisation, respectively, now coincide with the direction of the force, whereas, earlier, the same axes were only relatively orientated to the state of motion of atom, but could have any arbitrary position in space. *The principle of selection* now refers simply to the equatorial quantum number, which is associated with the component of the moment of momentum of the atom in the direction of the lines of force, just as earlier the azimuthal quantum number was allocated to the whole moment of momentum.

Through the restriction to one direction of the components the effect of the principle of selection is clearly weakened. This is seen very simply if

the assumptions are as in § 7 of Chapter IV (limiting case of a field of force of intensity zero). There the azimuthal quantum number n allowed itself to be resolved into two parts, the equatorial n_1 and the "latitudinal quantum number" n_2 . By merely taking over this resolution and the consequent change in terminology (n_1 in place of the previous n for the equatorial quantum number, and n for the quantum sum $n_1 + n_2$), we may say: our principle of selection restricts only n_1 leaving n_2 free. But through this the limitation of n is partly removed. Instead of $|\Delta n| \leq 1$ in the case without forces, we have now $|\Delta n_1| \leq 1$, whereas

$$\Delta n = \Delta n_1 + \Delta n_2 = \begin{pmatrix} \pm 1 \\ 0 \end{pmatrix} + \Delta n_2.$$

On account of the freedom of Δn_2 , Δn , too, is now capable of assuming also values above 1 (or below -1 , respectively).

We apply this to an actual case by passing from the field with a definite direction of the lines of force, as hitherto considered, to a field in which the direction of the lines of force are unknown and change from atom to atom.

Electrically such a field is realised by a discharge tube of high current density. Free charges occur in it which produce spherical fields of force distributed arbitrarily. Different atoms are then under the influence of forces which differ in direction, and one and the same atom is subject to forces that vary with the time.

In this case the component of the moment of momentum in the direction of the lines of force and the corresponding equatorial quantum number are not observable since the direction of the lines of force is not defined. Only this equatorial quantum number, however, is restricted by the principle of selection. In the case of the azimuthal quantum number, which is alone observable, the principle of selection does not come into effect. So we arrive at the following conclusion which has been excellently confirmed by experiment (cf., for example, § 2 of the next chapter): *when the electric current density in the discharge tube is high the principle of selection is rescinded.*

What we have said here about *electric* force (in a definite direction) will also be applied to *magnetic* force, but with certain alterations of the argument, for which we refer to § 6 of this chapter.

Finally we have yet to speak of ideas of quite a different type, by which Bohr has arrived at the same results as ours in his latest researches,* and has, indeed, partly gone considerably beyond them. Bohr has set up a general "Principle of Correspondence between the Wave Theory and the Quantum Theory" which is added to the quantum theory as something foreign to its nature. We sketch it here for only the simplest case of purely periodic orbits; we give its general formulation in Note 10.

* Kopenhagener Akademie, 1918 (so far, Parts 1 and 2 have appeared).

In a mechanical system that periodically executes a cycle there belong to the stationary orbits of infinitely great quantum numbers a rotation number ("Umlaufzahl") that agrees with the vibration number (frequency) calculated according to the quantum theory for the transition of the electron from one such stationary path to a neighbouring path (cf. Note 10, in which the proof is straightway given for the general case of a conditionally periodic system). Since, according to classical electrodynamics, the rotation number of an electron coincides with the vibration number of the light-wave which it emits, we may say that in the region of infinitely great quantum numbers, the vibration frequencies coincide in the classical and the quantum theory. Moreover, since in atomic systems of the Bohr type the rotation number decreases to zero as the quantum number increases, this is in harmony with the theory of heat radiation for which, likewise, in the region of infinitely slow vibrations the results of the classical theory are confirmed by the quantum theory as well as by experiment. But the classical theory makes definite statements not only about the frequency but also about the *polarisation* and the *intensity* of the emitted vibrations. We can raise no objection, in the light of what we have just said, to regarding these statements as trustworthy, too, in the region of infinitely slow vibrations. Now, Bohr extends these statements, by extrapolation, to the region of rapid vibrations, too, that is he passes from infinitely great to *finite* quantum numbers. The justification for this can be found only by agreement with experiment. And experiment does, indeed, give convincing evidence in favour of Bohr's extrapolation. For Bohr derives by this means not only the rule of polarisation and the principle of selection as well as their non-validity for cases in which external forces are superimposed, but he and his pupil Kramers,* respectively, also find that when the intensity of the spectral lines is determined in the above way the results agree remarkably well with experiment.

Our object in the above discussion was the reverse of Bohr's. In leaving incomplete our process of finding the determining elements, in the wave theory, of the process of emission, we wished to fit wave theory and quantum theory together according to the immediately evident maxim of the conservation of energy and momentum and to prove that the conception of two views are compatible with each other. On the other hand, Bohr has discovered in his *principle of correspondence* a magic wand (which he himself calls a "formal" principle), which allows us immediately to make use of the results of the classical wave theory in the quantum theory. For the rest, in his discussion of the results, he also refers to the conservation of the moment of momentum, as a possible means of explanation, quite independently of, although simultaneously with, Rubinowicz. It is a source of satisfaction that Bohr's

* H. A. Kramers, "Intensities of Spectral Lines," Kopenhagener Akademie, 1919, p. 287.

method and our own, in spite of their opposite starting-points, agree in their essential results.

Hereby Bohr's method is not only of greater consequence in the question of intensity, but also leads to sharper and more definite results as regards the question of polarisation. Whereas we, in the case $\Delta n = 0$ (cf. pp. 266 and 272), attained our object only as a result of plausible reflections, the principle of correspondence comes to its decisions by unambiguous analytical criteria, namely, that in the case in which forces are absent the radiation is absent, and that when there is a field of force there is linear polarisation in the direction of the lines of force (details in Note 10).

In the matter of method the principle of correspondence has the great advantage that it postulates that Maxwell's theory be generally valid for long waves (Hertzian vibrations of wireless telegraphy), and that it does not throw overboard the many useful results, which the classical theory gives for optical waves and Röntgen rays, but makes fundamental use of them. From this point of view the quantum theory seems, as Bohr has several times emphasised, not to deny the classical wave theory but systematically to extend it.

We have to recognise the complete superiority of the principle of correspondence in the matter of atomic models. For here Bohr seems to have succeeded (cf. pp. 59 and 109), by using classical mechanics and electrodynamics, in arriving at definite statements about the periodic system and the atomic shells, which would have been inaccessible by any other route.

§ 4. The Orbits of the Hydrogen Electron in the Stark Effect

The influence of the electric field on the emission of the Balmer lines was discovered by J. Stark* in 1913 and was examined by him in the succeeding years experimentally in an exemplary fashion as far as all the details of the fine-structure † and polarisation, not only for hydrogen, but for a series of other elements, He, Li, etc. It was a happy coincidence that in the same year, 1913, Bohr's spectral theory was proposed and was elaborated far enough to be able to grapple with the problem of the electrical resolution of hydrogen lines. The solution of the problem was obtained simultaneously and along essentially similar lines by K. Schwarzschild ‡ and P. Epstein § in 1916. Whereas the classical theory failed completely, the quantum theory yielded all the many details of Stark's observations of the fine-structure in such complete coincidence

* Berliner Sitzungsber., Nov., 1913; Ann. d. Phys., **43**, 965 and 983 (1914). A summary has been given by J. Stark, *Elektrische Spektralanalyse*. Leipzig (Hirzel), 1914.

† Göttinger Nachr., Nov., 1914.

‡ K. Schwarzschild, *Zur Quantentheorie*, Berliner Sitzungsber., April, 1916, published on 11th May, the day of Schwarzschild's death.

§ P. S. Epstein, *Zur Theorie des Starkeffektes*, Ann. d. Phys., **50**, 498, (1916).

with experiment that it was no longer possible to doubt the correctness and unambiguity of the solution found.

We shall just shortly remark on the experimental difficulties of the problem. The object was to subject hydrogen atoms during their emission to a powerful electric field of, say, 100,000 volts per cm. This was not possible with the ordinary arrangement of the Geissler tube, in which the hydrogen lines are usually produced. Geissler tubes are comparatively good conductors; an electric field in it simply collapses. Stark, therefore, used in place of the Geissler tube the luminescence of a canal-ray tube in a layer directly behind the perforated cathode. By using an oppositely charged electrode placed parallel and close to the cathode, he was able to generate a uniform and measurable electric field in a space of a few millimeters. The shortness of the space between the electrodes of this additional field not only favours the production of the resulting great potential drop but also prevents (in accordance with the peculiar laws of the production of the dark space in discharge tubes) the occurrence of a spontaneous discharge between the electrodes. The potential difference is great enough to influence effectively the canal-ray ions that fly through the perforated cathode in the usual way and to distort perceptibly the electronic orbits which are being traversed in them.

In contradistinction to Stark, Lo Surdo* uses as a means of influencing the phenomenon of luminescence no additional field but the field of the discharge tube itself, and, indeed, the part within the dark space of the cathode. Thus his method sacrifices quantitative definiteness and homogeneity of field but offers special advantages for the purpose of qualitative observations.

The general experimental results of Stark and Lo Surdo, respectively, were:—

1. Every Balmer line becomes *split up* into a number of components.
2. The number of components increases with the *series number* of the line.
3. The components are *linearly polarised when viewed transversally* (transverse effect), being polarised partly parallel to the field (*p*-components) and partly perpendicularly to it (*s*-components).

We must then first define clearly what these terms usually signify. In the case of the *p*-components the *direction of the electric vibration* in the light ray at the point of observation is *parallel* to the lines of force of the external field; in that of the *s*-components, the direction of the electric vibration is *perpendicular* to these lines of force. Thus it is not the position of the optical plane of polarisation, as shown by a Nicol's prism, that is to serve to distinguish "*p*" and "*s*." Since, as we know, the plane of polarisation in the light ray is perpendicular to the direction of electrical vibration (or, what is the same, it passes through the plane of magnetic vibration), we should have to transpose the terms *p* and *s* if we

* Accad. dei Lincei, 23, 83, 117, 143, 252, 326 (1914).

judged them according to the plane of polarisation. The use of the words "parallel" and "perpendicular," as here applied, arose historically out of the ideas of the classical wave theory. If we imagine a vibrating electron to be added to the place at which the emitting atom is situated, then the wave emitted by this electron would have, according to the classical view, a direction of electric vibration that would have the same direction as the component of acceleration of the electron (\dot{v}_n in Fig. 7) that is effective in the direction of emission in question. The p - and the s -components thus arise, in classical language, from vibrations of an exciting electron, which take place parallel or perpendicularly to the line of force of the external field.

4. When viewed *longitudinally* (longitudinal effect) the p -components are *invisible* and the s -components are *unpolarised*.

5. The intense p -components in general lie on the *outside*, and the intense s -components on the *inside*.

6. In the case of hydrogen the resolution and the polarisation are distributed *symmetrically* on both sides of the original line, but in the case of other atoms, the distribution is largely *unsymmetrical*.

7. The distances of the components from the centre are, in the case of hydrogen, whole *multiplies of a certain smallest distance between the lines*, and indeed, measured in the scale of vibration numbers, there is the same line-interval for the various hydrogen lines.

8. The resolution (in particular, this smallest line-interval) increases *proportionally with the field*.

We have already formed in Chapter IV, page 237, a general theoretical idea of the cause of the Stark effect. We spoke there of the various possible ways in which one and the same Balmer line may be produced by circular or elliptic orbits with the same quantum sum. These various modes of origin certainly coincide in one line if no external field of force is present (and if, see Chap. VIII, § 3, we leave out of consideration the relativistic fine-structure). But they become separated if a powerful electric field is imposed.

Thus the Stark effect denotes the artificial separation of the various possible modes of production, which originally coincided in a Balmer line, of the initial and the final orbit, this separation being effected by the application of an external electric field. And, owing to the spatial position of the orbits, the composition of the same quantum sum out of three quantum numbers n_1 , n_2 , and n_3 is involved. This is easily understood from the fact that the effect of the electric field on the orbits of the hydrogen electron will be found to depend not only on the shape and size (two quantum numbers) but also on the spatial position of the orbit with respect to the electric lines of force (third quantum number). These orbits are in the electric field, no longer, of course, circular and elliptic but are more complicated curves. Our object is to select from the totality of mechanically possible orbits those that are distinguished in the light

of the quantum theory by choosing three appropriate quantum numbers n_1, n_2, n_3 , and by representing the orbital energy as a function of these quantum numbers. To each such quantum triplet n_1, n_2, n_3 , in the initial and the final orbit there corresponds in general a different component in the Stark fine-structure. The increasing number of components in the series of lines $H_\alpha, H_\beta, H_\gamma, \dots$ becomes immediately intelligible from this. As the quantum sum of the initial orbit gradually increases, the number of the quantum triplets into which this sum may be resolved also increases, and, in harmony with this number, the number of components of the corresponding picture of resolution in the Stark effect increases.

We now consider the mechanical problem: how does an electron move when under the influence of a fixed nuclear charge E (in the case of the hydrogen atom this $E = e$) and under the simultaneous action of an external homogeneous electric field of force of the intensity F ? This problem is contained in the more general one: how does a point-mass move when under the influence of two arbitrary and arbitrarily placed fixed (Newton-Coulomb) centres of attraction?

The appropriate co-ordinates for the treatment of this general problem are (according to Jacobi) the parameters of the families of confocal ellipses and hyperbolæ that are described about the two centres as foci, together with the angle counted from the line connecting the centres. If one of the centres is taken off to infinity whilst its attractive power correspondingly increases, the general problem reduces to our special one; at the same time the systems of confocal ellipses and hyperbolæ resolve into two families of confocal parabolas of which the second fixed

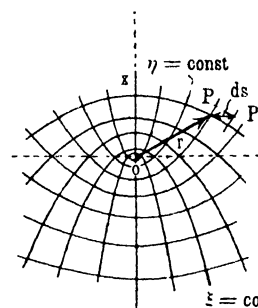

FIG. 77.

centre, the nucleus, is the focus, and the field direction through it is the common axis. We call the parameters of these two parabolic systems ξ and η . They, together with the angle ψ counted from the direction of the axis, are the co-ordinates which we shall have to use in our special problem.

In Fig. 77, O represents the nucleus, x the direction of the lines of force. The parabolas $\xi = \text{const.}$, $\eta = \text{const.}$, respectively have the equations:

$$\frac{\eta^2}{\xi^2} + 2x = \xi^2, \quad \frac{\eta^2}{\eta^2} - 2x = \eta^2 \quad . \quad . \quad . \quad (1)$$

For each point $P(x, y)$ of the plane we calculate by means of these equations the parameters ξ, η of the two parabolas which intersect at P . These two parameters may serve in place of x, y to define the point P , and hence also to determine the position of the electron within the plane of the diagram ("meridian plane"). To fix the position in space we use as the third co-ordinate the angle ψ that the meridian plane which passes

through the position of the electron at the moment in question makes with an arbitrary fixed meridian plane.

In the figure the lengths $OP = r$ and $PP' = ds$ are also drawn. The potential and kinetic energies of the electron are calculated from them. We show how these expressions are derived, and also how the parabolic co-ordinates are naturally introduced that lead to the eqns. (1) in Note 11 at the end of the book: here we write down at once the expression W for the total energy. In forming this expression as a function of the co-ordinates of position ξ, η, ψ and of the corresponding momentum co-ordinates p_ξ, p_η, p_ψ we call it Hamilton's function H (cf. Chap. IV, § 1, p. 194):

$$W = H = \frac{1}{2m(\xi^2 + \eta^2)} \left\{ p_\xi^2 + p_\eta^2 + \left(\frac{1}{\xi^2} + \frac{1}{\eta^2} \right) p_\psi^2 - \frac{1}{4mc^2} + mc^2(\xi^4 - \eta^4) \right\} \quad (2)$$

The relationship between the momentum co-ordinates p and the velocity co-ordinates $\dot{\xi}, \dot{\eta}, \dot{\psi}$ is given by the first triplet of Hamilton's equations, of eqn. (4) on page 194:

$$\frac{d\xi}{dt} = \frac{\partial H}{\partial p_\xi} = \frac{p_\xi}{m(\xi^2 + \eta^2)}, \quad \frac{d\eta}{dt} = \frac{\partial H}{\partial p_\eta} = \frac{p_\eta}{m(\xi^2 + \eta^2)}, \quad \frac{d\psi}{dt} = \frac{\partial H}{\partial p_\psi} = \frac{p_\psi}{m\xi^2\eta^2} \quad (3)$$

The second triplet of Hamilton's equations then states how the p 's alter dynamically:

$$\frac{dp_\xi}{dt} = - \frac{\partial H}{\partial \xi}, \quad \frac{dp_\eta}{dt} = - \frac{\partial H}{\partial \eta}, \quad \frac{dp_\psi}{dt} = - \frac{\partial H}{\partial \psi} = 0 \quad (4)$$

The last of these equations shows that p_ψ is a constant. This is nothing new to us for we saw on page 271 that in a homogeneous electric field the moment of momentum about the direction of the lines of force (even when the atom has a complex configuration) must be constant; accordingly, p_ψ is the "equatorial" areal constant.

The first two eqns. (4) are, if we replace H by the constant value W which it has after the differentiation has been performed:

$$\begin{aligned} \frac{dp_\xi}{dt} &= \frac{1}{m(\xi^2 + \eta^2)} \left\{ 2m\xi W + \frac{p_\psi^2}{\xi^3} - 2mc^2 F \xi^3 \right\} \\ \frac{dp_\eta}{dt} &= \frac{1}{m(\xi^2 + \eta^2)} \left\{ 2m\eta W + \frac{p_\psi^2}{\eta^3} + 2mc^2 F \eta^3 \right\} \end{aligned} \quad (5)$$

If we divide these two equations by the first two eqns. of (3) respectively, the differentiation with respect to t drops out in accordance with the scheme:

$$\frac{dp_\xi}{dt} \cdot \frac{d\xi}{dt} = \frac{dp_\xi}{d\xi}, \quad \frac{dp_\eta}{dt} \cdot \frac{d\eta}{dt} = \frac{dp_\eta}{d\eta}$$

and we get

$$\left. \begin{aligned} p_\xi \frac{d p_\xi}{d \xi} &= 2mW\xi + \frac{p_\psi^2}{\xi^3} - 2meF\xi^4 \\ p_\eta \frac{d p_\eta}{d \eta} &= 2mW\eta + \frac{p_\psi^2}{\eta^3} + 2meF\eta^3 \end{aligned} \right\} \dots \dots \dots (6)$$

It is worthy of note that the right-hand members of (6) are pure functions of ξ and η . We may therefore integrate and thus get p_ξ^2 as a function of ξ^2 and p_η^2 as a function of η^2 :

$$\left. \begin{aligned} p_\xi &= \sqrt{f_1(\xi)}, \text{ where } f_1(\xi) = 2mW\xi^2 - \frac{p_\psi^2}{\xi^2} - meF\xi^4 + C_1 \\ p_\eta &= \sqrt{f_2(\eta)}, \text{ where } f_2(\eta) = 2mW\eta^2 - \frac{p_\psi^2}{\eta^2} + meF\eta^3 + C_2 \end{aligned} \right\} \dots \dots \dots (7)$$

C_1 and C_2 are constants of integration. They become reduced to only one constant since p_ξ, p_η must satisfy the equation of energy (2). For if we insert $p_\xi^2 + p_\eta^2 = f_1 + f_2$ from (7) into (2), it follows that $C_1 + C_2 = 4meE$. Thus we may set

$$C_1 = 2m(eE - \beta), \quad C_2 = 2m(eE + \beta) \dots \dots \dots (7a)$$

where β is now the arbitrary solely remaining constant of integration. Eqns. (7) are derived a little more shortly and less artificially by the *method of separation of variables* in Note 11.

The essential result of our treatment so far is: *the parabolic co-ordinates of momentum are square roots of simple rational functions of the parabolic co-ordinates of position.*

From this theorem a general inference may be drawn, without further calculation, concerning the form of the orbital curves. Firstly, we see from (7) that during the motion ξ is limited to values for which $f_1 > 0$, since p_ξ must be real. Hence the extreme values that ξ may assume are the roots of $f_1(\xi) = 0$. We denote them by ξ_{min} and ξ_{max} . In the case $F = 0$, for which $f_1 = 0$ becomes a quadratic equation in ξ^2 , there are only two positive roots. In the case $F \neq 0$ a third root comes from infinity but it does not come into consideration for us; thus we take ξ_{min} and ξ_{max} to denote those two roots that proceed by continuous development from those of the case $F = 0$.

We next show that in the course of the motion ξ increases continually from ξ_{min} to ξ_{max} . For if ξ were to alter the sense of its progressive increase, we should have to have $\dot{\xi} = 0$. But then, by (3), $p_\xi = 0$. By (7), however, p_ξ cannot vanish if $f_1 = 0$, that is if $\xi = \xi_{max}$ or ξ_{min} . Thus ξ changes the sense of its progressive increase when it starts from $\xi = \xi_{min}$, for the first time at the point $\xi = \xi_{max}$. Whereas hitherto $p_\xi > 0$, from now on, the negative sign of the square root holds; when $p_\xi < 0$, we have, by (3), $\dot{\xi} < 0$.

The decrease of ξ now continues until $\xi = \xi_{min}$ and then passes over into a phase of increase, and so forth. We see that, *in the motion* ξ is

confined to the region between ξ_{min} and ξ_{max} and continually traverses this in alternate senses. The same holds for η . Here, too, the roots η_{min} and η_{max} of $f_2(\eta) = 0$ form the reversion points or "libration limits" (*Librationsgrenzen*) for the progress of the η -co-ordinate. At the same time we have in this behaviour of ξ and η a typical example of the general course of motion in the case of all "conditionally periodic systems" (cf. Note 7, No. 2). The continuous libration of the co-ordinates is proved in the general case just as in our special case.

The main features of the form of the orbits in the Stark effect are now exposed. In Fig. 78 we exhibit the curved quadrangle which is formed by the parabolas $\xi = \xi_{min}$, $\xi = \xi_{max}$, $\eta = \eta_{min}$, and $\eta = \eta_{max}$. The orbital curve is enclosed within these limits; it alternately touches a ξ - and an η -limit, and in the course of time closely covers the whole of the curved quadrangle. Our figure exhibits the conditions only in the meridian plane, that is, in a plane $\psi = \text{const}$. Besides the motion in this plane a rotation of the plane in space about the direction of the lines of force takes place in which the moment of momentum p_ψ is constant. By eqn. (3), there corresponds to it a quantity, the rotational velocity, $\dot{\psi}$, which is variable within certain limits. Hereby the plane orbital curve shown in the figure becomes a spatial orbital curve which continually circles round the direction of the lines of force.

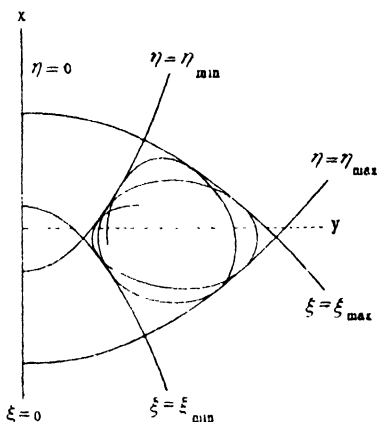

FIG. 78.

Only in the special case $p_\psi = 0$, in which $\dot{\psi}$ also = 0, the meridian plane remains at rest; the electron then describes a plane orbital curve in it. From the expression (7) for f_1 , it follows that when $p_\psi = 0$ one of the roots of $f_1 = 0$ vanishes. For if we multiply throughout by the denominator ξ^2 , we get

$$\xi^2(2mW\xi^2 - m_eF\xi^4 + C_1) = p_\psi^2$$

thus

$$\xi_{min} = 0 \text{ when } p_\psi = 0$$

and likewise it follows that

$$\eta_{min} = 0 \text{ when } p_\psi = 0.$$

But by Fig. 77, $\xi = 0$ and $\eta = 0$ respectively denote double the negative or the positive x -axis. Instead of the point of contact of the bounding parabolas ξ_{min} and η_{min} in Fig. 78, there then occurs an intersection of the x -axis on both sides of the nucleus. The orbital curve then assumes the form of Fig. 79.

Just as the orbital curve in Fig. 78 everywhere closely filled the

whole curved quadrangle between the bounding parabolas ξ_{min} , ξ_{max} , η_{min} , η_{max} , or the whole ring region, in a spatial sense, between the corresponding paraboloids, so also the whole curved two-sided space between the bounding parabolas is everywhere *closely occupied* in the course of the motion by our plane curve in Fig. 79. From this it follows that our electron must finally, some time or other, *collide with the nucleus*.

The special case $p_\psi = 0$ in the Stark effect is thus analogous to the special case of an ellipse that degenerates into a double straight line in the case of the Kepler motion (cf. the dotted lines in Figs. 71A, B, C, D). We shall draw here the same inference as in the Kepler case, namely, that this orbit which lies in the meridian plane and which collides with the nucleus cannot exist as a stationary state of motion and is to be excluded from the series of quantum states.

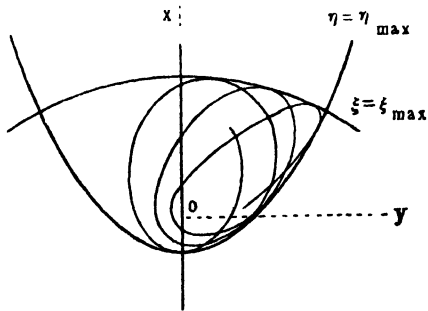

FIG. 79.

Now that we have discussed the essential features of the mechanical aspect of the problem, we turn to the quantum aspect. It is clear that we shall have to apply the quantum conditions to our co-ordinates ξ , η , ψ . Taking n_1 , n_2 , n_3 to denote integers, we then postulate

$$\oint p_\xi d\xi = n_1 h, \quad \oint p_\eta d\eta = n_2 h, \quad \int_0^{2\pi} p_\psi d\psi = n_3 h \quad (8)$$

we call n_3 the *equatorial quantum number*. The integration with respect to ψ is to be taken over all positions ψ of the meridian plane from 0 to 2π . Since p_ψ is constant, we get

$$2\pi p_\psi = n_3 h, \quad p_\psi = \frac{h}{n_3} \quad (9)$$

n_3 may assume all integral positive values *except zero*. We exclude zero on the ground of the collision between the electron and the nucleus considered above.

Let n_1 and n_2 be called *parabolic quantum numbers*. The integration with respect to ξ and η refers to the whole of the region of values of these variables, that is, in the case of ξ , from ξ_{min} to ξ_{max} and back to ξ_{min} , and correspondingly for η . In eqns. (8) this closed integration path is denoted by the sign \oint . It may also be replaced by twice the one way from ξ_{min} to ξ_{max} or from η_{min} to η_{max} respectively. But it is better to take full advantage of these simplifications that result from the circumstance that the path of integration is closed. This occurs in Note 6 in sub-section f.

n_1 and n_2 may assume all positive integral values *including zero*. The

case $n_1 = 0$ denotes that the integration path in the first integral (8) shrinks to the length zero, that is, that $\xi_{min} = \xi_{max}$. In this case the eqn. $f_1 = 0$ has two equal roots. The two bounding parabolas $\xi = \xi_{min}$ and $\xi = \xi_{max}$ in Fig. 78 merge into one and the orbital curve runs to and fro on this bounding parabola between the limits η_{min} and η_{max} . Considered spatially, it then lies on a paraboloid of revolution, of which it everywhere completely covers a portion enclosed between two parallel circles. The same is true for $n_2 = 0$, in which η_{min} becomes equal to η_{max} . Since these paraboloidal orbital curves always remain at a finite distance from the nucleus during the whole course of the motion, there is no reason for excluding them from the family of stationary curves.

The case $n_1 = n_2 = 0$ also belongs to the possible stationary orbits. It is characterised by two pairs of coincident roots: $\xi_{min} = \xi_{max}$ and simultaneously, $\eta_{min} = \eta_{max}$. The curved quadrangle of Fig 78 contracts into a point and the orbit consists, regarded spatially, of a *circle* that is described about the direction of the lines of force. Its centre does not, however, coincide, as in the case in which no forces are present, with the nucleus, but is displaced towards the side of the negative lines of force (negative x -axis), as we see at once, if we inquire into the equilibrium between the action of the nucleus and the external field of force. In particular, there belongs to this simplest circular type of orbit the *unexcited natural orbit* of the hydrogen atom (for which the quantum sum = 1) in the electric field. For if we are to have $n_1 + n_2 + n_3 = 1$, then, on account of $n_3 > 0$, it follows of necessity that $n_1 = n_2 = 0$.

The totality of quantised orbits thus forms a triply infinite discontinuous group and is represented by the scheme of quantum numbers

$$n_1 = 0, 1, 2 \dots, \quad n_2 = 0, 1, 2 \dots, \quad n_3 = 1, 2, 3 \dots$$

In the limiting case $F = 0$ of a vanishing field each member of the group becomes a Kepler ellipse with the nucleus as a focus. We might be led to suppose that in this limiting case our present group merges into the triply infinite group which resulted from spatial quantising in Chapter IV, § 7, and which was represented by the scheme

$$n' = 0, 1, 2 \dots, \quad n_2 = 0, 1, 2 \dots, \quad n = 1, 2, \dots$$

But this is not so. Our present quantum numbers have a different meaning than the former ones, since they are based on a different co-ordinate system. Accordingly, also the position and the shape of the Kepler ellipses will now be different. We discuss this further in the final section of this chapter. In mathematical language, the ambiguity of this result is due to the fact that in the Kepler motion we are dealing with a *degenerate problem* (cf. p. 241). As in such a case there are several possible choices of co-ordinates, so there will be several different results of quantising. But from the physical point of view no ambiguity is admissible. Only one of our two methods of quantising can be physically true.

The following circumstance decides which of these two it is. The Kepler motion without external forces is a degenerate problem only so long as we consider it from the physically insufficient view-point of classical mechanics. From the relativistic view there is, at least for the plane problem, no ambiguity. On the other hand our treatment of the Stark effect in parabolic co-ordinates is possible only when we start from classical mechanics. That is, our quantising of the Stark effect holds only so long as classical mechanics is applicable. This is the case with strong electric fields but not with arbitrarily weak fields. Whether a field is to be regarded as strong or weak in this sense may be most simply determined as follows. Let $\Delta\nu_F$ be the resolution that an electric field F effects in a Balmer line. Let $\Delta\nu_{II}$, on the other hand, be the natural doublet interval of the Balmer lines (cf. p. 209) which is accounted for by relativistic mechanics. If $\Delta\nu_F < \Delta\nu_{II}$, the field is called weak; if $\Delta\nu_F \gg \Delta\nu_{II}$, as is always the case when observations of the Stark effect are made, the field is to be called strong. In the latter case the quantising performed in this section is correct, in the former case it fails. The passage to the limit for the field zero is thus not allowable. In physical language, therefore, the present method of quantising the Kepler motion for the case when no external forces are acting is wrong, but the method of the preceding chapter remains true.

The question, interesting as regards method but difficult, as to how we are to quantise in the case of very weak electric fields has been answered quite definitely by H. A. Kramers.* As it is of no account for the interpretation of the Stark effect, after what we have just said, we shall not discuss it. But in speaking of the Paschen-Back effect in Chapter VIII, § 7, we shall again have to refer to it.

In saying above that when we quantise Kepler's problem in parabolic co-ordinates different ellipses result than when we quantise in polar co-ordinates, this difference affects the shape, but not the *energy* of the orbits. As we shall see at the beginning of the next section, the energy comes out exactly the same by each method so long as the quantum sum that enters into it is assumed the same in each. This holds not only for the present case of Kepler ellipses, but generally for degenerate problems: as far as the calculation of the energy and the spectral consequences that result therefrom are concerned, the ambiguity that otherwise attaches to degenerate systems disappears.

§ 5. The Resolution of the Balmer Lines in the Stark Effect

If in the first two eqns. (8) of the preceding section we imagine $\sqrt{f_1(\xi)}$ and $\sqrt{f_2(\eta)}$ written for p_ξ and p_η , only two unknowns occur in the left sides of (8), namely, the energy constant W and the integration con-

* Zeitschr. f. Phys., 3, 199 (1920).

stant β . These two constants are, by eqn. (8), brought into relation with the two quantum numbers n_1 and n_2 and may each be calculated separately from these. Since p_ψ also occurs in the expressions for f_1 and f_2 , and since, by (9), p_ψ is proportional to n_3 , the expressions that we are seeking for W and β will depend on all three quantum numbers n_1, n_2, n_3 . What interests us above all is the *expression for* W . We get for it, as shown in Note 11, if we develop our expression in increasing powers of the intensity of field F and stop at the first power:

$$-W = \frac{2\pi m e^2 E^2}{h^2} \frac{1}{(n_1 + n_2 + n_3)^2} + \frac{3h^2 F}{8\pi^2 m E} (n_2 - n_1)(n_1 + n_2 + n_3) \quad (1)$$

The first term on the right denotes the energy of the electron when the field is free. We designate it by $-W_0$ and may write

$$-W_0 = \frac{R h (E/e)^2}{(n_1 + n_2 + n_3)^2} \quad (2)$$

Since we thus get the same value as when we quantise the Kepler motion free of forces in polar co-ordinates, cf. eqn. (20), p. 236, we have proved the statement made at the close of the preceding section: in spite of the difference in the paths the energy is the same in both cases so long as the quantum sum is the same ($n_1 + n_2 + n_3 = n + n'$).

The second term on the right of eqn. (1) denotes the change of energy in the electrical field. We designate it by $-\Delta W$ and then have

$$-\Delta W = \frac{3h^2 F}{8\pi^2 m E} (n_2 - n_1)(n_1 + n_2 + n_3) \quad (3)$$

From the change in energy we may calculate the change in the vibration number, or the **resolution**, according to the formula

$$h\Delta\nu = \Delta W_a - \Delta W_r.$$

Let the quantum numbers n_1, n_2, n_3 refer to the final state e , the quantum numbers k_1, k_2, k_3 to the initial state a . Then we find

$$\Delta\nu = \frac{3hF}{8\pi^2 m E} \{ (n_2 - n_1)(n_1 + n_2 + n_3) - (k_2 - k_1)(k_1 + k_2 + k_3) \} \quad (4)$$

We now assert that this eqn. (4) contains the whole of the experimental facts which the researches of Stark have exposed in the case of hydrogen. Our result is a little more general in that it includes, besides hydrogen, atoms of the hydrogen type. In the case of hydrogen itself we must set $E = e$. Eqn. (4) is of course to be supplemented by the *principle of selection* and the *rule of polarisation*, as was developed in the case of an electric field in § 3.

Firstly, we read out of (4) the experimental facts described in 7 and

8, on page 278: all resolutions of lines $\Delta\nu$ in the Balmer series are *whole multiples of a smallest line-interval*:

$$C = \frac{3hF}{8\pi^2 m E} \dots \dots \dots (5)$$

As the intensity of field increases, this smallest line-interval and hence also the whole picture of the resolution of each Balmer line becomes magnified *proportionally to F*.

We read the experimental fact 6 on page 265 out of eqn. (4) just as directly: in the case of each Balmer line the resolution is *symmetrical* about the original line. For if the transition

$$k_1 k_2 k_3 \rightarrow n_1 n_2 n_3 \dots \dots \dots (6)$$

is possible according to the principle of selection, then so also is the transition

$$k_2 k_1 k_3 \rightarrow n_2 n_1 n_3 \dots \dots \dots (6a)$$

If the former gives rise to a component at a distance $\Delta\nu$ from the original line, then, by 4, the latter gives rise to a component at a distance $-\Delta\nu$. The *polarisation*, too, is the same for each component. For this is decided only by the equatorial quantum numbers, which are the same for each pair of transitions such as (6) and (6a).

Concerning the type of the polarisation our rule of polarisation states:

if $k_3 = n_3 \pm 1 \dots \dots \dots (7)$

then (cf. p. 273) a wave is emitted which is circularly polarised around the direction of the lines of force. In the transverse effect such a wave appears under all circumstances to be polarised *perpendicularly to the lines of force* (in the sense defined more closely on p. 277). In the longitudinal effect, it would be observed as a circular wave if only *one* process of emission were to be seen. In reality each observation represents a section through many elementary phenomena. These split up into two groups, as far as the hydrogen atoms are concerned, which originally circulate around the lines of force in one or the other direction respectively. Both directions of circulation are equally frequent and cannot be distinguished energetically. The same quantum transition that leads to the right-circular polarisation of the one group leads from the, so to speak, antipodal standpoint of the other group, to left-circular polarisation. The superposition of these two groups thus brings it about that, in the direction of the lines of force, no polarisation is observed.

If, on the other hand,

$$k_3 = n_3 \dots \dots \dots (8)$$

the direction of vibration that is unique in the state of polarisation (cf. p. 273) coincides with the direction of the lines of force. Consequently, in the transverse effect *linear polarisation is observed parallel to the lines*

of force. In the longitudinal effect these same components of the resolution are *invisible* according to the general rules of wave kinematics, which does not allow emission at all in the direction of vibration. These deductions agree literally with the experimental results which we stated under 3 and 4 on pages 277 and 278.

We next consider in turn the resolutions of $H_a, H_\beta, H_\gamma, H_\delta$, and use the abbreviation

$$K = (k_2 - k_1)(k_1 + k_2 + k_3), \quad N = (n_2 - n_1)(n_1 + n_2 + n_3). \quad (9)$$

$$\Delta = \frac{\Delta^r}{C} = N - K, \quad \dots \dots \dots (10)$$

According to (4) and (5) Δ denotes the displacement, measured in terms of the unit measure C , of the component in question compared with the original line. We set up the totality of possible transitions in a table and count them up according to the value of the azimuthal quantum number k_3 , by letting k_3 decrease from its respective greatest value to its smallest value 1. The value $k_3 = 0$, just like the value $n_3 = 0$, is to be excluded, according to page 283. Furthermore, we classify the transitions according to the type of polarisation. In the case of H_a , we have

$$k_1 + k_2 + k_3 = 3, \quad n_1 + n_2 + n_3 = 2$$

that is,

$$K = 3(k_2 - k_1), \quad N = 2(n_2 - n_1).$$

For the *parallel components* ($k_3 = n_3$), the value $k_3 = 3$ drops out, because n_3 can have no value greater than 2. We thus begin our enumeration with $k_3 = 2$. Whereas the corresponding final orbit is fully determined, namely 002, there are two initial orbits belonging to $k_3 = 2$, namely (102) and (012). The two transitions thus possible, namely,

$$102 \rightarrow 002 \quad \text{and} \quad 012 \rightarrow 002$$

differ, however, like the transitions (6) and (6a) only in that the first two quantum numbers are interchanged simultaneously and thus give rise to components that lie symmetrically. In our table we show only the first of the two transitions which lead to a positive Δ , and throughout we imagine the symmetrical components, with a negative Δ added, that arise through the simultaneous interchange of the first two quantum numbers, and we also give the numbers K, N , and Δ in accordance with (9) and (10). Then we consider $k_3 = 1$ and the corresponding final orbits with $n_3 = 1$. Here there are three transitions that lead to a positive Δ and just as many that belong to an equally great negative Δ , which will not be stated in the table. The electrically resolved line H_a thus consists, on both sides, of four components of which the line-intervals are to be read out of Table 27.

TABLE 27

H α , *p*-components, $k_3 = n_3$

$k_1 k_2 k_3 \rightarrow n_1 n_2 n_3$	K	N	Δ
102 \rightarrow 002	- 3	0	3
111 \rightarrow 101	0	- 2	2
201 \rightarrow 101	- 6	- 2	4
201 \rightarrow 011	- 6	+ 2	8

TABLE 28

H α , *s*-components, $k_3 = n_3 \pm 1$

$k_1 k_2 k_3 \rightarrow n_1 n_2 n_3$	K	N	Δ
003 \rightarrow 002	0	0	0
102 \rightarrow 101	- 3	- 2	1
102 \rightarrow 011	- 3	+ 2	5
201 \rightarrow 002	- 6	0	6
111 \rightarrow 002	0	0	0

Passing on to the perpendicular components, we begin with $k_3 = 3$, $n_3 = 2$, corresponding to the first transition given in Table 28, namely, 003 \rightarrow 002; circular orbit \rightarrow circular orbit (cf. p. 284). Starting from $k_3 = 2$ and $k_3 = 1$, we get in each case two transitions, as may be read from the table. The component $\Delta = 0$ arises in two ways; besides this, there are three transitions with a positive Δ , and, of course, just as many with a negative Δ .

We compare with this the result of the observations of Stark. Fig. 80 is a slightly altered copy of Stark's original diagram (re-drawn from the scale of $\Delta\lambda$'s to that of the $\Delta\nu$'s). The length of the strokes indicates the intensity of the resolved components as estimated by Stark. A sign of interrogation denotes that the existence of the component in question is uncertain. The accompanying numbers give the resolution (in wave numbers) as multiples of the fundamental unit C, that is, our Δ .

Here we see that *as far as $\Delta = 4$ the theoretical predictions agree perfectly with the observations made of H α* . For example the places 0 and 1 are free of *p*-components and occupied by *s*-components, whereas the reverse is the case with the places 2, 3, and 4, both in theory as in experiment. It is, however, true that the theory gives several components of greater resolution, 8 as a *p*-component, and 5 and 6 as an *s*-component, which were not shown up in the experiment.

Is this a reason for distrusting the theory? By no means. As we have left the question of intensities quite out of consideration here, it signifies little that we do not observe a theoretical component; for theory might disclose that the intensity of such a line is very feeble. This is

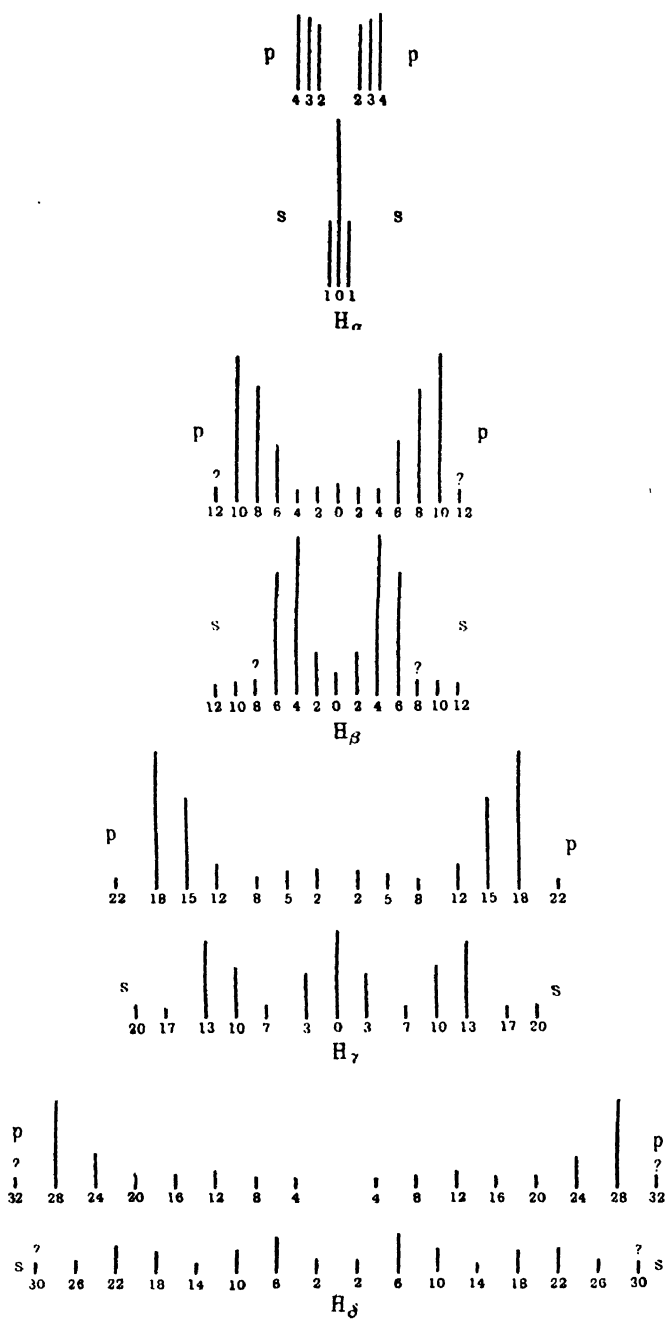

FIG. 80.

completely confirmed by the dissertation of Kramers (cf. p. 273) in which the question of intensity is treated with complete rigour according to Bohr's principle of correspondence. On the other hand, Stark emphatically leaves open the possibility, in particular in the case of H_α , that in addition to the observed components, still other weaker ones may yet be present.

If, however, a doubt should still remain about H_α , it would be removed by a look at the complete picture of the resolutions of H_β , H_γ , and H_δ . It convinces us absolutely of the truth of the theory.

The following tables require no further explanation. In the case of the p -components of H_β we have to begin our tabulation again with $k_3 = 2$, on account of $k_3 = n_3$ and $n_3 \leq 2$. There are two transitions from $k_3 = 2$, and four from $k_3 = 1$, which, according to the principle of selection, lead to p -components on the positive side ($\Delta > 0$). The symmetrical components on the negative side here again arise by interchanging the first two quantum numbers in the scheme of transition of the initial and the final orbit, and are to be imagined added. The number of transitions that lead to positive (or negative, respectively) s -components is just as great, namely equal to 6.

TABLE 29
 H_β , p -components, $k_3 = n_3$

$k_1 k_2 k_3 \rightarrow n_1 n_2 n_3$	K	N	Δ
202 \rightarrow 002	- 8	0	8
112 \rightarrow 002	0	0	0
301 \rightarrow 011	- 12	+ 2	14
301 \rightarrow 101	- 12	- 2	10
211 \rightarrow 101	- 4	+ 2	6
211 \rightarrow 011	- 4	- 2	2

TABLE 30
 H_β , s -components, $k_3 = n_3 \pm 1$

$k_1 k_2 k_3 \rightarrow n_1 n_2 n_3$	K	N	Δ
103 \rightarrow 002	- 4	0	4
202 \rightarrow 011	- 8	+ 2	10
202 \rightarrow 101	- 8	- 2	6
112 \rightarrow 011	0	+ 2	2
211 \rightarrow 002	- 4	0	4
301 \rightarrow 002	- 12	0	12

The agreement with the experimental picture of the resolution in Fig. 80 is again striking. All the theoretical components have been observed; besides these, however, there are shown, in Fig. 80 among the p -components, $\Delta = 4$ as a very weak line and $\Delta = 12$ as questionable, and among

the s -components $\Delta = 0$ as weak and $\Delta = 8$ as questionable. It may very well be that a revision or repetition of these observations will disclose these components as unreal or produced by a secondary effect. The s -component, $\Delta = 4$, which is observed as the most intense line arises, according to our table, in two ways, and this partly explains its predominating intensity. For a more detailed discussion of questions of intensity we must refer to Kramers.

In the case of H_γ the agreement between theory and observation is absolutely perfect. The theory gives the following picture:—

TABLE 31

 H_γ , p -components, $k_3 = n_3$

$k_1 k_2 k_3 \rightarrow n_1 n_2 n_3$	K	N	Δ
302 \rightarrow 002	- 15	0	15
212 \rightarrow 002	- 5	0	5
401 \rightarrow 011	- 20	+ 2	22
401 \rightarrow 101	- 20	- 2	18
311 \rightarrow 011	- 10	+ 2	12
311 \rightarrow 101	- 10	- 2	8
221 \rightarrow 011	0	+ 2	2

TABLE 32

 H_γ , s -components, $k_3 = n_3 \pm 1$

$k_1 k_2 k_3 \rightarrow n_1 n_2 n_3$	K	N	Δ
203 \rightarrow 002	- 10	0	10
113 \rightarrow 002	0	0	0
202 \rightarrow 011	- 15	+ 2	17
302 \rightarrow 101	- 15	- 2	13
212 \rightarrow 011	- 5	+ 2	7
212 \rightarrow 101	- 5	- 2	3
401 \rightarrow 002	- 20	0	20
311 \rightarrow 002	- 10	0	10
221 \rightarrow 002	0	0	0

TABLE 33

 H_δ , p -components, $k_3 = n_3$

$k_1 k_2 k_3 \rightarrow n_1 n_2 n_3$	K	N	Δ
402 \rightarrow 002	- 24	0	24
312 \rightarrow 002	- 12	0	12
222 \rightarrow 002	0	0	0
501 \rightarrow 011	- 30	+ 2	32
501 \rightarrow 101	- 30	- 2	28
411 \rightarrow 011	- 18	+ 2	20
411 \rightarrow 101	- 18	- 2	16
321 \rightarrow 011	- 6	+ 2	8
321 \rightarrow 101	- 6	- 2	4

TABLE 34
 H_δ , s-components, $k_3 = n_3 \pm 1$

$k_1 k_2 k_3 \rightarrow n_1 n_2 n_3$	K	N	Δ
303 \rightarrow 002	- 18	0	18
213 \rightarrow 002	- 6	0	6
402 \rightarrow 011	- 24	+ 2	26
402 \rightarrow 101	- 24	- 2	22
312 \rightarrow 011	- 12	+ 2	14
312 \rightarrow 101	- 12	- 2	10
222 \rightarrow 011	0	+ 2	2
501 \rightarrow 002	- 30	0	30
411 \rightarrow 002	- 18	0	18
321 \rightarrow 002	- 6	0	6

The observations, pictured in Fig. 80, are identical in every detail.

The same is true of H_δ .

The wonderful numerical regularity of the pictures exhibiting the resolutions is brought to light in the following remarks.

In the case of H_β and H_δ , only even multiples of the interval Δ occur, and, indeed, this is so both in theory and in experiment. (The theoretical reason is that, in the case of H_β and H_δ , the common divisor 2 of the quantum sum in the first and second term of their series-expression remains preserved in the quantity $\Delta = N - K$.)

In the case of H_β the components are partially, in that of H_γ and H_δ fully polarised, again both in theory and in experiment. (This is shown in the theory in that the Δ -values of the p - and s -series in the scheme of H_β partly overlap.)

The succession of components in the sequence of lines H_α , H_β , H_γ , H_δ becomes less and less dense. The interval between neighbouring components is 1 unit for H_α , 2 units for H_β , 3, or 4 units alternately for H_γ , 4 units without exception in the case of H_δ .

It now seems almost self-evident that, besides the ratios of the intervals of the components, also *the absolute values of the distances* will be given correctly by the theory. The absolute value of the resolution is given by our constant C in eqn. (5) and depends on the field F. The latter cannot be determined very accurately experimentally (hardly to within 1 per cent.). We may therefore correct the measured field intensity, as Epstein has done, by using the values calculated from the actual resolution, and, trusting, justifiably, in the truth of the theory, use the resolution in the Stark effect as a means of measuring accurately an electric field, just as the resolution in the Zeeman effect has occasionally been used to measure a magnetic field. The corrected field intensity thus found differs from that measured by Stark by only very little (107,000 compared with 104,000 volt/cm.).

All in all, we may regard the theory of the Stark effect as one of the most striking achievements of the quantum theory in atomic physics.

§ 6. The Zeeman Effect

In 1896 Zeeman discovered that the lines of the series spectra may be influenced by magnetic means. In the simplest case there appear instead of one line, when viewed *longitudinally*, that is when the ray is in the direction of the magnetic lines of force, two lines (**Zeeman doublet; longitudinal effect**), but when viewed *transversely*, that is when the ray is perpendicular to the magnetic lines of force, instead of one line, three lines are observed (**Zeeman triplet; transverse effect**).

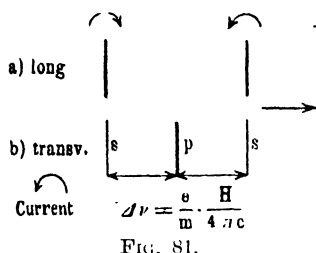

Of the latter three lines one occupies the position of the original unresolved line, and the other two are displaced by equal amounts to greater or smaller wave-lengths, and occupy the same position in the spectrum as the two lines of the doublet in the longitudinal effect (cf. Figs. 81, *a* and *b*).

The displacement amounts to

$$\Delta\nu = \frac{e}{m} \frac{H}{4\pi c} = 4.70 \cdot 10^{-5} \cdot H \quad (1)$$

where H = the intensity of the magnetic field in absolute units (Gauss). If we wish to measure ν in sec.^{-1} , we have to take e on the right side of the equation as the *electrostatic* charge of the electron; but if we measure ν in cm.^{-1} as a "wave number," then e is the charge on the electron measured in electromagnetic units, and $e/m = 1.77 \cdot 10^7$ is the specific charge on the electron measured in the same way. The numerical value $4.70 \cdot 10^{-5}$ in eqn. (1) refers to the latter method of measuring ν , and thus gives the displacement $\Delta\nu$ in the scale of wave numbers.

In the first observations of Zeeman the lines were not completely separated, because the resolution was too feeble and the lines were too wide. But he succeeded in establishing beyond doubt the presence of polarised light at the extreme edges of the line configuration. The type of the polarisation is indicated in our figure. The symbols p and s (parallel and perpendicular, German *senkrecht*, to the lines of force) mean the same as on page 277. They refer not to the position of the optical plane of polarisation but to the direction of the electrical vibrations in the ray at the place of observation. In the longitudinal scheme the *circular arrows* denote that *circular polarisation* was observed, and, as is shown; the sense in the two lines of the doublet is opposite. In general, in the short-wave component the sense of the circular polarisation is the same as that of the positive current in the coils of the electromagnet, which produces the magnetic field, and, of course, in the long wave component the sense is reversed.

We first wish to emphasise that our two figures *a* and *b* express the same facts under different circumstances of observation. The p -com-

ponent of the transverse effect must be ineffective in the longitudinal effect and that is why in Fig. 81a no line occurs at the position of the transverse p -component. Actually, this p -component arises from a vibration phenomenon for which the direction of the lines of force is a line of symmetry of the intensity (or, expressed in the language of the older theory, it is due to the vibration of an electron, which moves in the direction of the lines of force). But such a vibration, as we know and have already used in the Stark effect on page 288, emits no light. On the other hand, the circular components that occur in the longitudinal effect are due to a vibration phenomenon, in which the plane of vibration is perpendicular to the lines of force (in words of the old theory, due to the vibration of an electron, which describes a circle in this plane). Such a vibration phenomenon, however, sends out in a direction perpendicular to its unique axis, that is, in the transverse direction, linearly polarised light, whose electric force vibrates in the plane of vibration, that is perpendicular to the magnetic lines of force, likewise analogous to the circumstances in the Stark effect, cf. page 287. Hence the s -components of the transversal scheme correspond to the circular components of the longitudinal scheme. Accordingly, it is sufficient to study the Zeeman effect in only one direction, for example, in the transverse direction which is more convenient for purposes of observation: then the picture that must be obtained when observations are made in the longitudinal direction may be derived from the latter quite easily.

The facts so far described are fully explained by *Lorentz's Theory of the Zeeman Effect*. This is based on the assumption of quasi-elastically bound electrons, which excite vibrations in the ether that are synchronous and in constrained connexion with the vibrations of the electrons (cf. the end of § 1). More precisely: the electron is considered bound to a position of rest in the atom in such a way that when it is displaced a restoring force acts on it proportional to this displacement from the position of rest, and, indeed, the force is the same for all *directions* of the displacement. We know nowadays that this picture is too simple and restricts the true scope of atomic phenomena. Nevertheless it has proved of great service for explaining the typical Zeeman effect.

For let us imagine the motion of such an electron in a magnetic field. Whatever it may be in itself, we may resolve it into a linear component which takes place in the direction of the magnetic lines of force and into two circular components that take place perpendicularly to the latter with reversed senses of revolution. The first component is not influenced by the magnetic field, so that its frequency of vibration is the same as when the magnetic field is not present. *That is why we get the p -component in the position of the original line* (when no field is present) *when the observations are made transversely*. The two circular components are for the one part accelerated and for the other retarded by the magnetic field. *Hence we have the two circular components in the case of longitudinal*

observation, or respectively the two *s*-components in that of transverse observation, displaced by an amount $\Delta\nu$ with respect to the line when no field is present; and the displacement is the same in each direction and proportional to the magnetic field H . Equation (1), which expresses mathematically these facts, is a direct consequence of Lorentz's theory of the phenomenon. The value (1) will therefore still be called the **Lorentz difference of vibration** or the **Lorentz displacement**. Its method of derivation assumes besides the idea of a quasi-elastically bound electron only the recognised laws about the influence of magnetic forces on moving charges (law of Biot and Savart). The sense of the circular polarisation in the one or the other component of the Zeeman doublet also follows from Lorentz's theory if the *negative* sign of the electronic charge is taken into account.

Lorentz's theory, however, far from includes the whole complex of facts of magneto-optic phenomena; rather, it is limited to lines of the simplest structure.

In the case of multiple lines (doublets, triplets) there occur in place of the "normal Zeeman effect" of Fig. 81 the so-called **anomalous** or **complex Zeeman types**. We shall treat these in detail in the next chapter.

Here we deal only with the normal Zeeman effect and shall show how this may be understood on the quantum theory. For this purpose we consider the simplest atomic model, that of hydrogen, consisting of a singly charged nucleus and an electron in the magnetic field. In the last section of the previous chapter we have already spatially quantised the orbits of the electron (the nuclear mass being ∞) for a field of force of which the intensity is zero. We can reduce the action of an arbitrary homogeneous magnetic field H to this case. For, following Larmor, we state that *the superimposed field H leaves the form of the orbits and their inclination to the magnetic lines of force, as also the motion in the orbit, unaltered, and merely leads to the addition of a uniform "precession" of the orbit about the direction of the lines of force, the precessional velocity being*

$$\omega = \frac{1}{2} \frac{e}{m} \frac{H}{c} \quad (2)$$

This law holds provided that the velocity imparted to the electron by the precessional motion alone is small compared with the velocity that the electron would have in its path without the precessional motion; under the circumstances of our atomic model this is the case even for the strongest magnetic field that can be produced. The proof of Larmor's theorem is based on the conception of Coriolis forces, which is known from the mechanics of relative motions (for example, from the circumstances of the rotating earth).

Generalising somewhat from the special conditions of the hydrogen atom, we consider the motion of a point-mass m under the influence of

forces that are distributed symmetrically about a certain axis A, which, for example, arise from centres of force on this axis. We call the co-ordinate system of reference there used the **static system of reference**. We next imagine the point-mass to traverse the same orbit at the same rate but relatively to a system of reference which turns about the axis A with the uniform velocity \mathbf{o} relative to the static system of reference. In this case the motion of the point-mass is no longer natural or free. Rather, to maintain this motion, forces in addition to those acting in the static system are necessary which just neutralise the inertial resistances of the rotation. These inertial resistances are, in the first place, the ordinary centrifugal force

$$Z = m\mathbf{o}^2\rho \quad . \quad . \quad . \quad . \quad . \quad (3)$$

where ρ signifies the respective distance of the point-mass from the axis A; and, secondly, the composite centrifugal force or Coriolis force

$$C = 2m[\mathbf{v}\mathbf{o}] \quad . \quad . \quad . \quad . \quad . \quad (4)$$

where \mathbf{v} is the velocity of the point-mass in the orbit that is being turned, and $[\mathbf{v}\mathbf{o}]$ is the vector product of \mathbf{v} and the vector of rotation \mathbf{o} drawn in the direction of the axis A (cf. Note 1). Eqn. (4) determines not only the magnitude but also the direction of C, the latter as the common normal to the directions of \mathbf{v} and A. On the other hand, the force, which a magnetic field H exerts on the electronic charge ($-e$) moving with the velocity \mathbf{v} is, according to the laws of electromagnetism,

$$K = -\frac{e}{c}[\mathbf{v}\mathbf{H}] \quad . \quad . \quad . \quad . \quad . \quad (5)$$

This force exactly neutralises the Coriolis force if the direction of the lines of force coincides with the direction of the axis A and if, also, the condition for the magnetic field holds (we equate C and K):

$$2m\mathbf{o} = \frac{e}{c}\mathbf{H}, \quad \mathbf{o} = \frac{1}{2} \frac{e}{m} \frac{\mathbf{H}}{c} \quad . \quad . \quad . \quad . \quad (6)$$

If we disregard the centrifugal force Z for the moment, then a magnetic field of suitably chosen intensity is just able to bring into equilibrium the inertial action of the electron in its rotating orbit. Thus, in the magnetic field H, the rotating orbit is a natural orbit or, in other words, *the electron describes in the magnetic field the same path as when no magnetic field is acting but doing so with respect to a system of reference which is rotated with the velocity \mathbf{o} determined by the eqn. (2) or (6). Regarded from the standpoint of this system of reference the orbits are traversed as if no field were present. Precession of the system of reference and action of the magnetic field are interchangeable and equivalent to one another.*

Concerning the ordinary centrifugal force Z we may easily convince ourselves, on the basis of the restriction made in Larmor's theorem, that

it may be neglected in comparison with C . This restriction is, in our present symbols :

$$\rho \ll v \quad \dots \quad (5a)$$

As we see from the expressions (3) and (4), it is identical with

$$Z \ll C.$$

We now revert to the hydrogen atom. We know the totality of its orbits in the absence of a magnetic field (merely ordinary Kepler orbits). By what has just been proved we also know the totality of its orbits when a magnetic field is present (Kepler orbits with a motion of precession about the direction of the lines of force). Thus we have a complete survey of the *mechanically possible* orbital curves. We have now only to select those that are possible on the *quantum* hypothesis. For the "fieldless" case this has also been done in the preceding chapter : we obtained Kepler orbits of a definite shape and with a definite inclination to the direction of the lines of force. But now we have seen that the orbits when a magnetic field is present are, from the standpoint of the precessional system of reference, fieldless orbits. Hence if we carry over the quantising of the fieldless orbits from the static system to the precessional system of reference, we get *for the quantised orbits with a field the same orbits in the precessional system of reference as we get without a field in the static system*. In the next section we shall trace this application of quanta, which was here introduced merely as an obvious special step, back to a general principle.

Thus we set up the quantum conditions for the magnetic field just as previously for the case when the "field was zero." By introducing polar co-ordinates r, θ, ψ in the *precessional system of reference*, we have

$$\int p_r dr = n' h, \quad \int p_\theta d\theta = n_2 h, \quad \int p_\psi d\psi = n_1 h \quad \dots \quad (7)$$

From this we conclude as in Chapter IV, § 7, eqns. (2), (3), (4), (9), and (8) :

$$\left. \begin{aligned} 2\pi p \left(\frac{1}{\sqrt{1 - \epsilon^2}} - 1 \right) &= n' h, & 2\pi p &= (n_1 + n_2) h \\ \cos \alpha &= \frac{n_1}{n_1 + n_2}, & 2\pi p_\psi &= n_1 h \end{aligned} \right\} \quad \dots \quad (8)$$

Here the quantities ϵ and θ are by definition independent of whether we refer them to the static or the rotated system ; on the other hand, the quantities p and p_ψ are, in conformity with their nature, to be *measured in the system of reference which is turned with the velocity \mathbf{o}* . Hence we take ψ explicitly as denoting the geographical longitude of the relative position of the electron in the rotating system of reference and distinguish it from the geographical longitude χ in the static system of reference. The connexion between these quantities is clearly

$$\dot{\chi} = \dot{\psi} + \mathbf{o}, \quad \chi = \psi + \mathbf{o}t \quad \dots \quad (9)$$

We now form the *expression for the kinetic energy of the electron*, first when there is a magnetic field, $E_{kin}(H)$, and again when there is none, $E_{kin}(0)$. The latter expression is :

$$E_{kin}(0) = \frac{m}{2} (\dot{r}^2 + r^2 \dot{\theta}^2 + r^2 \sin^2 \theta \dot{\psi}^2) \quad (10)$$

At the same time this denotes the kinetic energy of the electron, when there is a magnetic field, related to our rotating system of reference. The kinetic energy, when there is a magnetic field, related to our static system of reference, is therefore (we merely interchange ψ and χ) :

$$E_{kin}(H) = \frac{m}{2} (\dot{r}^2 + r^2 \dot{\theta}^2 + r^2 \sin^2 \theta \dot{\chi}^2) \quad (10a)$$

By substituting from (9), we get

$$E_{kin}(H) = \frac{m}{2} (\dot{r}^2 + r^2 \dot{\theta}^2 + r^2 \sin^2 \theta \dot{\psi}^2 + 2r^2 \sin^2 \theta \dot{\psi} \mathbf{o} + \dots) \quad (10b)$$

The last member (not written here) is quadratic in \mathbf{o} and hence, owing to the restriction contained in Larmor's theorem, is to be neglected. If we also take into account the significance of p_ψ :

$$p_\psi = \frac{\partial E_{kin}(0)}{\partial \dot{\psi}} = m r^2 \sin^2 \theta \dot{\psi}$$

as well as the expression for $E_{kin}(0)$ in eqn. (10), we may write in place of (10b) :

$$E_{kin}(H) = E_{kin}(0) + p_\psi \cdot \mathbf{o} \quad (10c)$$

Finally, we introduce the expression

$$\Delta E_{kin} = E_{kin}(H) - E_{kin}(0)$$

as the change in kinetic energy of the electron arising through the magnetic field H , and express p_ψ , by eqn. (8), in terms of the quantum number n_1 . We thus get from (10c)

$$\Delta E_{kin} = \frac{n_1 \mathbf{o} h}{2\pi} \quad (11)$$

On the other hand we have, as regards the potential energy,

$$\Delta E_{pot} = 0 \quad (11a)$$

For the potential energy of the Coulomb attraction $\frac{e^2}{r}$ undergoes no change through the introduction of the magnetic field, since the distance r in the precessional and the original orbit remains the same within the limits of accuracy of our calculation.

Hence from (11) and (11a) we get for the magnetic change of the total energy W of the electron

$$\Delta W = \frac{n_1 \mathbf{o} h}{2\pi} \quad (12)$$

Likewise we get for the difference of the total energy in the initial and final orbit of the electron

$$\Delta W_a - \Delta W_e = \frac{n_{1a} - n_{1e}}{2\pi} \mathbf{o} h \quad (13)$$

Now, just as the frequency ν of the emitted spectral line is determined from Bohr's condition

$$h\nu = W_a - W_e$$

so the effect of the magnetic field is given by the condition

$$h\Delta\nu = \Delta W_a - \Delta W_e.$$

Hence eqn. (13) states that

$$h\Delta\nu = \frac{n_{1a} - n_{1e} h}{2\pi}$$

or, if we insert the meaning of h from (6):

$$\Delta\nu = (n_{1a} - n_{1e}) \frac{e H}{m 4\pi c} \quad (14)$$

We firstly note that in the transition from (13) to (14), the quantum of action, h , has characteristically cancelled out. *In our final formula (14) the quantum theory has in a certain sense become latent in that its characteristic feature, the quantity h , has disappeared.* In this we see a reason that it was possible to develop magneto-optics in Lorentz's theory to a certain degree on the classical, pre-quantum, basis. In electro-optics (Stark effect) and in the general optics of spectral lines this was hopeless from the outset, because here the quantum of action h played, not a latent, but an explicit part.

We next observe that our final formula (14) agrees not only in its general structure but also in almost all its details with the result of Lorentz's theory, that is with eqn. (1) and Fig. 81 at the beginning of this section. To see this we have only to enlist the aid of our principle of selection. In the magnetic field this concerns, as in the electric field, only the *equatorial* quantum number n_1 (called n_3 in the Stark effect) and states that:

$$n_{1a} - n_{1e} = \pm 1 \text{ or } 0 \quad (15)$$

From (14) we therefore get

$$\Delta\nu = \pm \frac{e H}{m 4\pi c} \text{ or } \Delta\nu = 0 \quad (16)$$

In this form our quantum result agrees fully with the result of Lorentz's theory: *we have before us not only the two lines of the Zeeman triplet which are both displaced by the amount $\Delta\nu$ to greater and smaller frequencies but also the undisplaced line $\Delta\nu = 0$.* In contradistinction to (16), our original formula (14) would lead us to expect superfluous components of the resolution that would be displaced two, three, . . . times as much as the normal resolution. The fact that such components are, under normal* circumstances, not observed is a strong confirmation of our principle of selection in its application to the magnetic case.

* In the reproduction of a photograph of the Zeeman effect in hydrogen taken by Paschen and Back, Ann. d. Phys., 39, Plate VIII, Fig. 4, Bohr discerned a faint impress of the lines of twice the normal resolution and ascribed it to the unintended simultaneous action of an electric field. On the original photograph lines of three times

But not only *the displacement of the Zeeman components* but also their polarisation comes out correctly in our theory. This becomes immediately evident if we can convince ourselves that our rule of polarisation originally derived for an electric field may be applied to the magnetic field. For then we have circular polarisation in the case $\Delta n = \pm 1$, and linear polarisation parallel to the lines of force in the case $\Delta n = 0$, corresponding to the two possibilities distinguished in eqn. (15). Applied to eqn. (16) this means the following:—

Viewed longitudinally *the two external components* of the Zeeman effect are *circularly polarised*, and, indeed, in opposite directions; the plane of vibration is perpendicular to the magnetic lines of force. Viewed transversely, these lines must consequently be *linearly polarised at right angles to the lines of force*. *The middle component* of the Zeeman effect is *polarised linearly and perpendicularly to the lines of force*.

Concerning the extension of the rule of polarisation and the principle of selection from the electric to the magnetic case, we seek to justify it by the following not quite inevitable reasoning:—

Let us again picture to ourselves the orbit of the electron, both in the precessional system in which its plane is firmly fixed, as in the “static system of reference,” in which it is rotated through the action of the magnetic field with the constant angular velocity ω . In the precessional system of reference we erect the vector of the moment of momentum as a normal to the orbital plane; here it has a constant magnitude and direction, and hence also constant projections along the direction of the lines of force and in the equatorial plane. Regarded from the static system of reference, it describes a circular cone about the direction of the lines of force with the constant angular velocity ω . From the standpoint of the static system of reference, however, there becomes added to the “moment of momentum without rotation” “the moment of momentum of the rotation itself,” which alters in magnitude and direction, with the distance of the electron from the nucleus. Hence, strictly speaking, the cone that is described in the static system of reference by the vector of the total moment of momentum is not a circular cone. Its projection in the equatorial plane of the static system is slowly rotated in the course of the precession (corresponding to the circumstance that there are no areal constants for the equatorial axes of the static system) and also its projection on the direction of the lines of force is not exactly constant (strictly speaking, the law of sectorial areas is also rescinded by the action of the magnetic field for the direction of the lines of force.)

Nevertheless there is a great difference between the manner in which this component is not constant along the direction of the lines of force

the normal resolution can be seen. Just as the lines of normal resolution confirm the principle of selection, so the lines of double and triple resolution give a striking example of how the principle of selection is rescinded by electric fields, as was explained on page 274.

and that in which it is not constant in the equatorial plane. The component along the lines of force exhibits only brief fluctuations (of the same period as the period of revolution of the electron); the component at right angles to it performs, besides, a slow rotation in the equatorial plane (of the same period as that of the precession). In view of the condition (6a), on which, alone, Larmor's theorem and our treatment of the Zeeman problem is justified, even the variable part of the component along the lines of force vanishes in comparison with the constant part. On the other hand, in consequence of the same condition the rotation of the equatorial component of the moment of momentum is, indeed, infinitely retarded, but for a sufficient lapse of time it entails a complete reversal of the corresponding moment of momentum of the component in question.

From this we conclude, as on page 271, for the case of an electric field, that we can postulate the conservation of the moment of momentum in the coupling of the atom with the ether only for the direction of the lines of force. Hence only the equatorial quantum number n_1 that refers to the rotation about the direction of the lines of force is bound by the condition imposed by the principle of selection. From this there results the eqn. (15) already used, and the corresponding rule of polarisation.

It is instructive to trace in detail the scheme of quantum transitions and the position of the orbital planes in the Zeeman effect, for example, for the line H_α . We find it expedient to start from the scheme of quantum transitions for the Stark effect, with which our present scheme agrees in design but from which it differs in that the quantum numbers have other meanings in the inferences. Our present quantum numbers n' , n_2 , n_1 correspond to r , θ , ψ . In turn they replace the quantum numbers n_1 , n_2 , n_3 in the Stark effect. Our present equatorial quantum number n_1 is subject to the same selective condition for the parallel and perpendicular components as the equatorial quantum number n_3 formerly. Our present quantum sum $n' + n_2 + n_1$ is, just like the former sum $n_1 + n_2 + n_3$, equal to 2 for the final orbit of H_α . Our present quantum sum $k' + k_2 + k_1$ for the initial orbit is, like the earlier sum $k_1 + k_2 + k_3$, equal to 3. Thus if we enquire as to what quantum numbers lead in the Zeeman effect to parallel polarised light, we arrive at the same transitions $k_1 = n_1$ as were enumerated in the first column of Table 25. But there is the following difference between the Stark effect and the Zeeman effect. Whereas in the Stark effect the first two quantum numbers n_1 and n_2 have essentially the same meaning, in the sense that a simultaneous interchange of them in the initial and the final state leads to two essentially equal resolutions (differing only in sign), the meaning of the first two quantum numbers n' and n_1 in the Zeeman effect is entirely different. Thus two transitions that differ through the simultaneous interchange of these two numbers are therefore not of equal value (equivalent) in the Zeeman effect. In this way there becomes added, in the case of the p -components of H_α , to

the first column of the following table, which has been borrowed from Table 25 dealing with the Stark effect, the second column in which $(n'n_2)$ and $(k'k_2)$ have been interchanged.

But there is still a second difference. In the Kepler motion under no external forces, all those transitions are excluded by our principle of selection (p. 269), in which the sum $n_1 + n_2$ does not alter by one unit. Reasons of continuity make us inclined to regard this rule of exclusion as valid in the magnetic field (this may be proved rigorously with the help of Bohr's principle of correspondence). The transitions separated out in this way are bracketed in the following table. Thus, of the eight transitions only four remain. From our present non-relativistic standpoint, they of course all lead to the same parallel polarised component $\Delta\nu = 0$. We shall see later in Chapter VIII that upon closer calculation and observation they are slightly separate. Corresponding tables may be set up for the s -components of H_α , as for H_β , H_γ , . . .

TABLE 35
 H_α , p -components

$k'k_2k_1 \rightarrow n'n_2n_1$	$k'k_2k_1 \rightarrow n'n_2n_1$
(102 \rightarrow 002)	012 \rightarrow 002
111 \rightarrow 101	(111 \rightarrow 011)
(201 \rightarrow 011)	021 \rightarrow 011
201 \rightarrow 110	(021 \rightarrow 101)

In Table 35 the following circumstance is worthy of note. In the non-bracketed orbits the number-pair k_2k_1 is throughout different from n_2n_1 . As this number-pair determines the position of the orbital plane (cf. Chap. IV, § 7, eqn. (9)) in the initial and the final orbit, respectively, it follows that the orbital plane changes position in the transitions that here come into question (and partly also in those belonging to the s -components). In the first non-bracketed transition, for example, the initial orbit is inclined at an angle of 60° with the equatorial (cf. Fig. 64b), and the final orbit coincides with the equatorial plane, and so forth.

So we see, whereas in the Kepler motions, free of forces (cf. p. 269), the orbital plane remains preserved, it alters in general in the Zeeman effect; through spatial quantising a discontinuity is introduced into the position of the orbital plane as compared with its position for Kepler orbits. Here "orbital plane" refers to that in the rotating system of reference.

Concerning the observation of the polarisation in the longitudinal effect, the following difference in the Zeeman and the Stark effects is yet to be noted. In the Stark effect the transitions that would lead to right and left polarised light are equivalent energetically. They therefore occur in one and the same line and produce unpolarised light. In the

Zeeman effect they are distinguished from one another magnetically, and therefore produce different line components circularly polarised in opposite directions.

When in 1916 the author* investigated the Zeeman effect on the basis of the quantum theory, he felt himself impelled to emphasise in a concluding remark that "Bohr's energy equation $h\nu = W_u - W_l$ (also called frequency condition), being a scalar equation, can never account for the polarisations." We now see that this gap has in the meanwhile been successfully bridged over, as it was only necessary to add to the energy equation the equation of the moment of momentum. As already remarked at the beginning of this chapter, the observation of the polarisation historically preceded the quantitative observation of the resolution and was exhibited with greater certainty. Accordingly, the quantum theory of the Zeeman effect can be regarded as quite complete and valid only since the polarisation phenomena have been fitted into it.

In its present state the quantum treatment of the Zeeman effect achieves just as much as Lorentz's theory, but no more. It can account for the normal triplet, including the conditions of polarisation, but hitherto it has not been able to explain the complicated Zeeman types (p. 296). The perfect agreement between final results obtained in two such different ways is highly remarkable from the point of view of method, and again betrays an intimate and certainly not accidental correspondence between the quantum and the classical view of radiation phenomena.

§ 7. The Adiabatic Hypothesis

At the first Solvay Congress,† in the year 1911, H. A. Lorentz proposed the question as to how a simple pendulum behaves when its length is shortened by holding the thread between two fingers and drawing it up between them. If it has initially exactly the correct energy that corresponds as an energy element to its frequency, then at the end of the process when the frequency has become increased this energy would no longer suffice to make up a full energy element.

Einstein at once furnished the correct reply in saying that the suspending thread must be shortened infinitely slowly and then the energy would increase proportionally to the frequency and would continue to be equal to an energy element.

This answer is covered by Ehrenfest's **Adiabatic Hypothesis**.‡ We

* *Physikal. Zeitschr.*, **17**, 491 (1916). Cf. also the somewhat earlier work of Debye, *ibid.*, p. 507, or *Göttinger Nachr.*, June, 1916.

† *Rapports du Congrès*, Paris, 1912, p. 450.

‡ First set up by P. Ehrenfest in connection with the problems of "cavity radiation" in *Ann. d. Phys.*, **36**, 91 (1911), §§ 2 and 5, and then applied by him to other problems; see *Verh. d. Deutsch. Physikal. Ges.*, **15**, 451 (1913); *Amsterd. Academy*, **22**, 586 (1913); *Phys. Zeitschr.*, **15**, 657 (1914). A detailed survey for systems of several degrees of freedom is contained in *Ann. d. Phys.*, **51**, 327 (1916). Cf. also J. M. Burgers, *ibid.*, **52**, 195 (1917). Bohr, who early recognised the importance and the fruitfulness of this method, calls it the "Principle of Mechanical Transformability."

formulate it according to its general significance as follows : Let us consider any arbitrary mechanical system and an arbitrary initial state of motion which is correctly quantised. We now alter the state infinitely slowly by gradually imposing an arbitrary external field of force or by gradually altering the inner constitution of the system (length, mass, charge, connections). This causes the original state of motion to be transformed by mechanical means to a new state of motion. **For the new conditions of the system this new state of motion is a quantum-favoured state if the original state was so under the original conditions ; it corresponds to the same quantum numbers n_1, n_2, \dots as the latter.**

The expression "*Adiabatic Hypothesis*" is taken from thermodynamics. Just as in an adiabatic change of state in thermodynamics the co-ordinates that determine the heat motion are not directly affected, but only indirectly while no heat is added from without and the conditions of the system are altered (for example, the volume, the position in the gravitational field, and so forth), so in the applications of the adiabatic hypothesis to the quantum theory the motion of the system is not controlled directly by external agency ; for such agency acts, not on the co-ordinates of the motion, but on a parameter of the system. Just as in thermodynamics an adiabatic change of state is to be regarded as a chain of states of thermal equilibrium, so in the quantum theory the adiabatic transformation from the original to the final quantum state has to occur infinitely slowly, that is by passing through intermediate states of equilibrium of motion. Quantities that remain unaltered during this transformation are called **adiabatic invariants**. The quantum numbers that fix the original state are by the adiabatic hypothesis themselves such invariants. All other adiabatic invariants must be expressible in terms of these simplest invariants.

There are three characteristics that are both necessary and at the same time sufficient for adiabatic processes. 1. *The infinitely slow or reversible* element of the process. In thermodynamics phenomena are also known that occur without the addition of heat but are irreversible (for example, the diffusion of a gas when no cotton-wool aperture is used). Such processes are not adiabatic in the present sense. 2. *The effect* not on the *co-ordinates of the motion* but on one or more *parameters* of the system, that remains constant in the original motion. 3. *The unsystematic or irregular nature of the influence* (effecting the alteration) in relation to the phases of motion. Even in the case of the simple pendulum we could intentionally carry out the shortening of the thread in such a way that the energy of motion there remains constant, if we draw up the thread only at the points at which the motion is periodically reversed. In that case, as Warburg remarked at this Solvay Congress, a contradiction to Einstein's assertion and to the quantum theory would arise. Such intentional or methodical alterations are then in no case to be included in the category of adiabatic processes.

We next consider the mechanical aspect of the question. The fact that in ordinary mechanics we set aside the adiabatic processes is not because they are less interesting, but because they are more difficult in comparison with the ordinary problems of mechanics. In the case of the simple pendulum, we easily attain our object by direct calculation without having to seek support from the general laws of adiabatic invariance, which we shall develop from this example.

Let l be the length of the pendulum, m its mass (concentrated at a point), ϕ the angle of the instantaneous deflection, c the amplitude, and ν the frequency, so that

$$2\nu\pi = \sqrt{g/l} \quad . \quad . \quad . \quad . \quad . \quad (1)$$

The tension S acting on the thread is, as we know,

$$S = mg \cos \phi + ml\dot{\phi}^2$$

in which the first part is due to gravity, the second to the centrifugal force. If we shorten the thread infinitely slowly by $|dl|$, we have to perform work against the tension; its amount is

$$dA = \bar{S} |dl| = -mg \overline{\cos \phi} dl - ml\bar{\phi}^2 dl \quad . \quad . \quad . \quad (2)$$

The horizontal bar denotes that the time average is to be taken and indicates that during the shortening by the amount dl many swings of the pendulum are to occur. The negative sign occurs because $|dl|$ is to denote a shortening, so that dl itself is negative. From

$$\phi = c \sin (2\pi\nu t + \gamma)$$

it follows that

$$\overline{\cos \phi} = 1 - \frac{1}{2}\bar{\phi}^2 = 1 - \frac{c^2}{4} \bar{\phi}^2 = (2\pi\nu)^2 \frac{c^2}{2} = \frac{g}{l} \frac{c^2}{2} \quad . \quad . \quad . \quad (3)$$

thus

$$dA = -mg \left(1 - \frac{c^2}{4}\right) dl - mg \frac{c^2}{2} dl = -mg \left(1 + \frac{c^2}{4}\right) dl.$$

The one part, $-mgdl$, of this work dA is used to raise the mean position of the weight mg . The remainder,

$$dA' = -mg \frac{c^2}{4} dl \quad . \quad . \quad . \quad . \quad (4)$$

increases the energy E of the motion of the pendulum. This total energy E is twice as great as the mean kinetic energy :

$$\bar{E}_{kin} = \frac{m}{2} l^2 \bar{\phi}^2 = mgl \frac{c^2}{4} \quad . \quad . \quad . \quad . \quad (5)$$

Hence the change in the mean total energy is

$$d\bar{E} = mg \frac{c^2}{2} dl + mglc dc \quad . \quad . \quad . \quad . \quad (6)$$

By equating (4) and (6) we get

$$-\frac{3}{4} c dl = l dc.$$

Integrating,

$$\begin{aligned} \frac{3}{4} \log l &= -\log c + \text{const.} \\ lc &= \text{const.} \end{aligned} \quad (7)$$

From this it follows that when the pendulum is shortened adiabatically the angular amplitude c increases, as may easily be seen by performing the experiment, whilst at the same time the linear amplitude lc decreases. Concerning the energy we conclude by comparing (5) and (7) that it increases when the pendulum is shortened adiabatically, as is evident from the work dA' performed; it is inversely proportional to \sqrt{l} .

By squaring (7), and inserting the values of lc^2 from (5) and \sqrt{l} from (1), we may write (7) in the form

$$\frac{E_{kin}}{\nu} = \text{const.} \quad (8)$$

and on account of the equality of \bar{E}_{kin} and \bar{E}_{pot} in our special case this entails that $\frac{\bar{E}}{\nu}$ is an adiabatic invariant, in accordance with the quantum law of the harmonic oscillator $\bar{E} = nh\nu$. Eqn. (8) is an illustration of the general law, the **quantum of action** (cf. Note 7, eqn. (5)):

$$2 \int_0^{\tau} E_{kin} dt = 2\tau \bar{E}_{kin} = \frac{2}{\nu} \bar{E}_{kin} \quad (9)$$

taken over a period is an adiabatic constant.

The *adiabatic invariance* of the quantity (9) already played a part in the general investigation made by Boltzmann to base the second law of thermodynamics on statistical considerations. Its relation to the quantum theory is clear from the equation:

$$2E_{kin} = \sum p_k \dot{q}_k, \quad 2 \int E_{kin} dt = \sum \int p_k dq_k \quad (10)$$

(cf. Note 4, eqn. (5)) which is valid for any arbitrary mechanical system. If we take this integral for a *purely periodic system* over the time T of a period, then we have on the right the sum of the phase integrals (cf. p. 198). From here we have a bridge to the more general class of *conditionally periodic systems* (Note 7, No. 2): *here each individual phase integral or each of the corresponding quantum numbers is an adiabatic invariant.* By proving this theorem in Note 12, we show that from the point of view of the adiabatic hypothesis our general quantum hypothesis of page 200 is justified; if, on the other hand, we adopt the opposite view of regarding this quantum hypothesis as an established fact, we prove the adiabatic hypothesis for the whole class of conditionally periodic systems. (In adiabatic transformations transitions through degenerate systems are excluded, as Bohr has shown and as will be proved in Note 12.)

We next use the adiabatic hypothesis to fill in various gaps that were left in the preceding section, firstly in the Zeeman effect.

To deal at the outset with the simplest case we consider a hydrogen atom in which the electronic orbits are circular in a plane which is perpendicular to the magnetic lines of force. Let a and ω be the radius and angular velocity in the circular orbit when the field is zero, and let $a + \Delta a$, $\omega + \Delta\omega$ be the same quantities when the field H has been imposed adiabatically. The flux of lines of force through the orbit is $H\pi a^2$. Since we regard it as a small quantity (of the order of the increments Δa , $\Delta\omega$, whose squares and products may be neglected) it suffices to use in it the original a instead of $a + \Delta a$. By Faraday's law of induction, the flux of the lines of force gives the whole electromotive force that is excited by the increasing field in the "circular current" of radius a , that is the work performed on the current "unity." Our rotating electron, the charge of which is e in E.S.U., represents a current which, measured in E.M.U., is of intensity $e v/c = e\omega/2\pi c$ (cf. p. 248). Thus, by setting the work performed equal to the change of energy ΔW of the electron, we get

$$H\pi a^2 \cdot \frac{e\omega}{2\pi c} = \Delta W \text{ or } \frac{1}{2c} e H a^2 \omega = \Delta E_{kin} + \Delta E_{pot} \quad (11)$$

Now

$$\left. \begin{aligned} E_{kin} &= \frac{m}{2} a^2 \omega^2, & \Delta E_{kin} &= m(a^2 \omega \Delta\omega + a\omega^2 \Delta a) \\ E_{pot} &= -\frac{e^2}{a}, & \Delta E_{pot} &= \frac{e^2}{a^2} \Delta a = m a \omega^2 \Delta a \end{aligned} \right\} \quad (12)$$

In the last transformation the equation for the centrifugal force

$$m a \omega^2 = \frac{e^2}{a^2} \quad (13)$$

By substituting (12) in (11) and dividing by $m a^2 \omega^2$, we get

$$\frac{\Delta\omega}{\omega} + 2\frac{\Delta a}{a} = \frac{e}{2m} \frac{H}{a\omega c} \quad (14)$$

A second equation is obtained from the circumstance that during the adiabatic change of state the dynamical laws, here the equation of centrifugal force, are to remain valid throughout.

In eqn. (13) we wrote down this equation only to a first approximation for the field zero. In general it is

$$m(a + \Delta a)(\omega + \Delta\omega)^2 = \frac{e^2}{(a + \Delta a)^2} + \frac{e}{c} H a \omega$$

or, when multiplied by $(a + \Delta a)^2$,

$$m(a + \Delta a)^3(\omega + \Delta\omega)^2 = e^2 + \frac{e}{c} H a^3 \omega \quad (15)$$

From this, by using (13) and dividing by $2ma^3\omega^2$, we get

$$\frac{\Delta\omega}{\omega} + \frac{3}{2} \frac{\Delta a}{a} = \frac{e}{2m} \frac{H}{\omega c} \quad (16)$$

By comparing (16) and (14) we see at once that

$$\Delta a = 0, \quad \Delta\omega = \frac{e}{2m} \frac{H}{c} = \mathfrak{o} \quad (17)$$

Hence, when the magnetic field is introduced adiabatically the radius *a* remains unchanged, the rate of rotation is changed by the amount \mathfrak{o} of the Larmor precession (cf. eqn. (2) of p. 296), being increased or diminished according to the direction of the field.

The same calculation may be carried out for a circular or elliptic path inclined to the lines of force, and the result is: as the magnetic field increases gradually, the size and the shape of the orbit remains preserved (corresponding to $\Delta a = 0$); but the rate of rotation becomes changed in that the angular velocity \mathfrak{o} about the axis of the lines of force becomes added. But this means: *the orbit as a whole performs a precessional motion.*

The limitation to a *gradually, that is infinitely slowly, increasing field* is absolutely necessary. The precessional orbit arises from the original one with the fixed orbital plane only if we pay due attention to the necessary initial velocity of the electron in the direction of precession (perpendicular to the lines of force). If the field is introduced suddenly, the momentary velocity of the electron is not affected; for a change of velocity to come about it is necessary that the electron traverse its orbit one or more times during the time that an appreciable change of the magnetic intensity of field takes place.

So far we have been dealing with *adiabatic mechanics*. The *quantum* aspect of the adiabatic change comes into question only if we wish to allocate quantum numbers to the changed motion. In the case of the circular orbit that is simply placed perpendicular to the lines of force, this has to occur, by the adiabatic hypothesis, thus: let the initial circular orbit (*a*, ω) be quantised, that is, let it be such that

$$ma^2\omega = \frac{n\hbar}{2\pi} \quad (18)$$

Then the altered motion (*a*, $\omega + \mathfrak{o}$) is also quantised, and corresponds also to the quantum number *n*. But this correspondence does not mean that now the formula

$$ma^2(\omega + \mathfrak{o}) = \frac{n\hbar}{2\pi} \quad (19)$$

holds, which would contradict the preceding eqn. (18); but rather, (18) still remains valid. Whereas, however, the left side of (19) denotes the moment of momentum in the static system of reference, the left side of

(18) represents the moment of momentum in the system of reference of which the precession is $\pm \mathbf{o}$. Thus the latter, not the former, is quantised. This is extended still further then to the general case of elliptic motion. *The precessional orbits in the magnetic field correspond to the same quantum numbers as the Kepler ellipses in the case when no magnetic field is present; but the phase integrals are not to be calculated with reference to the static, but with reference to the precessional co-ordinate system.*

This was, as a matter of fact, the method that we followed in the previous section (p. 298), and which is accordingly justified by the adiabatic hypothesis. The particular simplicity of the Zeeman effect now consists in the circumstance that in it the adiabatically altered orbits are identical in shape with the original orbits, and differ from them only in their precessional motion.

We now give a second application of the adiabatic hypothesis. In the case of an electric field (Stark effect), we showed that the orbits of which the equatorial quantum number is zero are to be rejected, because, finally, they would approach infinitely near the nucleus. We follow Bohr in concluding from this that, in the case of the magnetic field (Zeeman effect), the orbits of which the equatorial quantum number is zero are inadmissible, although in this case there is no question of a collision with the nucleus. The orbits that were not allowable in the electric field were such as were shown in Fig. 79; they were situated in a fixed meridian plane through the electric lines of force. The orbits that are to be rejected in the magnetic field are Kepler ellipses, which lie in a meridian plane through the magnetic lines of force, and are rotated around these.

To prove this, we imagine superimposed on the initial electric field a magnetic field of force increasing adiabatically from zero, and with its lines of force having the same direction. All that then happens is that the orbits due to the Stark effect are made to execute a precession in which their shape and rate of rotation are preserved. As a matter of fact, we proved Larmor's theorem on page 297 not only for a single nucleus, but for arbitrary centres of force, situated on the axis of revolution. The homogeneous electric field parallel to the axis of revolution, therefore, also falls within the scope of Larmor's theorem. We may now let the magnetic field increase to a desired amount, and afterwards allow the electric field to decrease adiabatically to zero. We thus transform in a perfectly continuous way the orbits of the Stark effect into the precessional orbits of the Zeeman effect. Here, quantised orbits remain quantised, allowable orbits remain allowable, and inadmissible ones remain inadmissible. Thus *the equatorial quantum number zero is inadmissible in the Zeeman effect because it is inadmissible in the Stark effect.*

A final application of the adiabatic hypothesis concerns the shape and position of the orbits in the Stark effect for the limit when the electric

field becomes vanishingly small, $\text{Lim } F \rightarrow 0$. We know (p. 284) that these orbits are Kepler ellipses, but that they differ from the Kepler ellipses in the case of no forces, or, better expressed, from those in the magnetic field of vanishing field intensity $\text{Lim } H \rightarrow 0$. Our object is to prove the relationship between the two groups of Kepler ellipses; we abbreviate them thus $K_F = 0$, $K_H = 0$.

The field F is to be in the direction of the x -axis (cf. Fig. 79). The potential energy of the electron in the field is eFx . The total energy is W , and is composed partly of kinetic energy, partly of potential energy in the field of the nucleus and in the external field F ; it remains constant during the motion so long as the external field is kept constant. If it is altered by an amount δF , the total energy alters by the amount $\delta W = ex\delta F$. Since the change δF of the field is to take place infinitely slowly, we may replace x by the time-mean \bar{x} for one or more revolutions and write:

$$\delta W = e\bar{x}\delta F.$$

We calculate \bar{x} from the time of revolution τ by means of the formula:

$$\bar{x} = \frac{1}{\tau} \int_0^{\tau} x dt \quad . \quad . \quad . \quad . \quad . \quad (20)$$

If the field increases from 0 to F , the change of energy is:

$$\Delta W = \int \delta W = \int_0^F e\bar{x}\delta F = e\bar{x}F \quad . \quad . \quad . \quad (21)$$

In the last term of this equation we have taken \bar{x} to be independent of F . In other words, we have neglected the change of \bar{x} due to the increasing field, as it entails in the expression of ΔW only a term in F^2 , with which we are not concerned. In particular, then, we may also calculate \bar{x} for the case $F = 0$ and accordingly take the integration in (20) over the orbit curve $K_{F=0}$.

On the other hand, we take ΔW from eqn. (1) of § 5. Here $-W$ was developed in powers of F and the higher powers were neglected; thus ΔW is equal to the term in F . We accordingly get, if we equate the two expressions for ΔW :

$$\begin{aligned} e\bar{x}F &= - \frac{3h^2 F}{8\pi^2 m e^2} (n_2 - n_1)(n_1 + n_2 + n_3) \\ \bar{x} &= - \frac{3h^2}{8\pi^2 m e^2} (n_2 - n_1)(n_1 + n_2 + n_3) \quad . \quad . \quad . \quad (21) \end{aligned}$$

On the right-hand side we introduce the major axis of the ellipse out of eqn. (18) on page 236, namely:

$$a = \frac{h^2}{4\pi^2 m e^2} (n_1 + n_2 + n_3)^2 \quad . \quad . \quad . \quad . \quad (22)$$

In this, we have set $E = e$ (hydrogen) and $n + n' = n_1 + n_2 + n_3$, corresponding with our present nomenclature of the quantum sum. The circumstance that a has the same value for our present ellipses K_{F-0} as for our earlier ones K_{H-0} , follows from the fact that we are comparing orbits having the same energy, and that, according to (19) on page 236, for orbits of equal energy a is the same. By substituting (22) in (21), we get

$$\bar{x} = \frac{3}{2} a \frac{n_1 - n_2}{n_1 + n_2 + n_3} \dots \dots \dots (23)$$

So far we have calculated \bar{x} from energy considerations. We now express it geometrically in terms of elements of the orbit. For this purpose we introduce into the orbital plane of the ellipse rectangular co-ordinates x', y' whose origin is at the nucleus and whose x' -axis lies along the major axis. We form \bar{x}' and \bar{y}' along the lines of eqn. (20). By symmetry $\bar{y}' = 0$. If θ and η are the inclinations of the x' - and the y' -axis to the x -axis we get

$$\bar{x} = \cos \theta \cdot \bar{x}' + \cos \eta \cdot \bar{y}' = \cos \theta \cdot \bar{x}' \dots \dots \dots (24)$$

By the law of sectorial areas, $p = mr^2\dot{\phi}$ (where r and ϕ are polar co-ordinates in the $x' - y'$ -plane, so that $x' = r \cos \phi$), we have

$$dt = \frac{m}{p} r^2 d\phi \dots \dots \dots (25)$$

and hence

$$\tau = \int_0^\tau dt = \frac{m}{p} \int_0^{2\pi} r^2 d\phi, \quad \tau \cdot x' = \int_0^\tau x' dt = \frac{m}{p} \int_0^{2\pi} r^3 \cos \phi d\phi \dots \dots \dots (26)$$

If we write the equation to the ellipse in the form (cf. p. 235, equ. (11))

$$\frac{1}{r} = A(1 + \epsilon \cos \phi), \quad A = \frac{1}{a(1 - \epsilon^2)} \dots \dots \dots (27)$$

then, by (26),

$$\tau = \frac{2\pi m}{pA^2} J, \quad \tau x' = \frac{2\pi m}{pA^3} J' \dots \dots \dots (28)$$

The integrals here denoted by J and J' have the significance:

$$J = \frac{1}{2\pi} \int_0^{2\pi} \frac{d\phi}{(1 + \epsilon \cos \phi)^2}, \quad J' = \frac{1}{2\pi} \int_0^{2\pi} \frac{\cos \phi d\phi}{(1 + \epsilon \cos \phi)^3}$$

J is worked out in Note 6 under (b); J' follows from it by differentiation

$$J = \frac{1}{(1 - \epsilon^2)^{3/2}}, \quad J' = -\frac{1}{2} \frac{dJ}{d\epsilon} = \frac{3}{2} \frac{\epsilon}{(1 - \epsilon^2)^{5/2}} \dots \dots \dots (29)$$

Hence by (28) and (27)

$$\bar{x}' = \frac{J'}{AJ} = \frac{3}{2A} \frac{\epsilon}{1 - \epsilon^2} = \frac{3}{2} a\epsilon. \quad (30)$$

and by (24) and (23)

$$\epsilon \cos \theta = \frac{n_1 - n_2}{n_1 + n_2 + n_3}. \quad (31)$$

Whereas in the case of the Kepler ellipse $K_{II} = 0$ (cf. eqn. (14) on p. 235), the eccentricity ϵ was fixed by the quantum numbers alone (there they were n and n'), there enters into the expression ϵ for the Kepler ellipse $K_F = 0$ the non-quantised angle θ . The limiting cases $K_{II} = 0$ and $K_F = 0$ thus actually differ from one another.

Our eqn. (23), deduced from adiabatic considerations, allows us to form a conclusion not only about the shape but also about the position of the orbits. For we read out of (23) that: if $n_1 > n_2$, then \bar{x} must > 0 , that is, the electron in traversing its orbit remains longer on the front side of the nucleus than on the rear side; if $n_1 < n_2$, then $\bar{x} < 0$, and the orbit conversely is longer on the rear side than on the front side of the nucleus. Here the front side denotes that which faces in the direction of the lines of force ($x > 0$).

As is clear from formula (4) on page 286 for the displacement of the lines in the Stark effect, the sign of $\Delta\nu$ is the same as that of $(k_1 - k_2)$. The line-displacement due to the initial orbit always exceeds considerably that due to the final orbit. Thus $k_1 > k_2$ produces a positive $\Delta\nu$, that is, a component on the short-wave side of the original line, whereas $k_1 < k_2$ produces a negative $\Delta\nu$, a long-wave component. Combining this with the preceding result, we may say: the short-wave (long-wave) components in the Stark effect are due to transitions in which the initial orbits lie more on the front side (rear side, respectively) of the nucleus.

This remark is useful for interpreting* certain differences of intensity between the long- and short-wave components,† which have been observed in rapid canal rays of hydrogen.

The author owes the latter arguments about the Stark effect to Mr. W. Pauli. They show how extraordinarily easily the adiabatic hypothesis allows us to solve problems which otherwise could be treated only by complicated calculations.

* Cf. N. Bohr, Phil. Mag., 30, 405 (1915); A. Sommerfeld, Jahrbuch f. Rad. und Elektr., 17, 417 (1921); A. Rubinowicz, Zeitschr. f. Phys., 5, 331 (1921).

† J. Stark, Elektr. Spektralanalyse, § 14 and § 33; H. Lunelund, Ann. d. Phys., 5, 517 (1914).

CHAPTER VI

SERIES SPECTRA IN GENERAL

§ 1. Empirical Data of the Scheme of Series

AS a result of extensive researches, spectroscopists have arrived at a number of physical points of view which enable them to arrange the lines into distinct series. These points of view are based on the structure and multiplicity of the lines, the ease with which they are produced, their blurredness or sharpness, their behaviour in the Zeeman effect, and so forth. There thus arose as the final criteria as to whether lines belonged to a certain series the possibility of expressing in a formula their regular sequence. For the sake of brevity, we shall begin here by describing the series in formulæ; the individual phenomena may then be conveniently derived from this description.

We must preface our remarks by saying that the existence of series cannot be proved for all elements (for further details, see § 6). The series character predominates only in the first three columns of the periodic system. In the fourth, fifth, and six columns, series relationships have been discovered only exceptionally (for example, in the case of O, S, Se, Mn). Towards the end of the periodic system, in the sixth, seventh, and eighth columns, the number of lines increases enormously (cf. the Fe-lines, and, indeed, those of all triad elements), to such an extent that hitherto it has been impossible to order the lines and combine them into series. Throughout, corresponding elements, that is, those that are in one vertical column in the periodic system, exhibit an analogous behaviour spectroscopically, in that they all have the series character, or are all devoid of it. This agrees with the view already expressed in Chapter II, § 7, that the visible spectra arise at the periphery of the atom, and hence behave similarly as regards structure if the peripheral structure is the same.

Each series is calculated, like Balmer's, as the difference of two "terms," *a constant first term* and *a variable second term*. We call the latter the *current term*. Just as in Balmer's case, the term is a function of an integer m , and of certain parameters that characterise the atom. We next give the usual nomenclature of the current term of the Principal Series, and of the First and Second Subsidiary Series.

The **Principal Series** (*Hauptserie*) is characterised by the letter p ; its current term is written thus :

$$\text{H.S.} \quad . \quad . \quad . \quad mp.$$

The integer m is called the current number; it distinguishes the individual successive members of the series from each other. The symbol p hints at the special atomic constants that are of account for this term.

The **First Subsidiary Series** (I *Nebenserie*) is also called the Diffuse Subsidiary Series owing to the blurred appearance of its lines; it is characterised by the letter d . The current term of the First Subsidiary Series is written thus :

$$\text{I N.S.} \quad . \quad . \quad . \quad md.$$

The **Second Subsidiary Series** (II *Nebenserie*) consists, as a rule, of sharp lines, and is also called the Sharp Subsidiary Series. Hence the letter s is used to denote its current term :

$$\text{II N.S.} \quad . \quad . \quad . \quad ms.$$

To these three series types that have been known for some considerable time there became added later, when the infra-red part of the spectrum first became accessible to analysis, the so-called **Bergmann Series** (called briefly, B.S.). We shall denote it by the letter* b , and shall write its current term :

$$\text{B.S.} \quad . \quad . \quad . \quad mb.$$

A survey of the totality of these series terms is given by the scheme

$1s$	$2s$	$3s$	$4s$	$5s$	$6s \dots$
	$2p$	$3p$	$4p$	$5p$	$6p \dots$
		$3d$	$4d$	$5d$	$6d \dots$
			$4b$	$5b$	$6b \dots$
				$5x$	$6x \dots$
					$6y \dots$

It expresses that the current number m in the s -term may take all integral values from 1 to ∞ , in the p -term all values from 2 to ∞ , and so forth. Further, it indicates in the bottom terms that still higher terms follow the b -term, in which m has values beginning from 5, 6, etc.; for the first of such terms we have proposed the symbol mx and my , etc.

Next, concerning the *constant term* of our various series, this coincides

* The use of the symbol Δp instead of b is due to Ritz: it was chosen on the assumption, which has since not been confirmed, that there is a numerical relationship between the series constants of the B.S. and the H.S. The name "Fundamental Series" (in place of Bergmann Series), which is usual in English and American literature where it is characterised by mf instead of mb , is founded on the "hydrogen-like" character of the Bergmann Series. We shall see on p. 317 that this is not a decisive characteristic of the B.S. If we wish to call a series term "fundamental," it should be the term I.S., which is, indeed, least "hydrogen-like," but is associated with the "fundamental orbit" of the atom (cf. the end of this section).

in the Principal Series with the term of the Second Subsidiary Series for $m = 1$; the constant term in the two subsidiary series is the term of the Principal Series for which $m = 2$; the constant term of the Bergmann Series is the term of the First Subsidiary Series for $m = 3$. We thus have, so far as the constant term is concerned:

H.S.	1s
I N.S.	2p
II N.S.	2p
B.S.	3d

The final mode of representing the series thus becomes in our four cases:

$$\left. \begin{array}{llll} \text{H.S.} & . & . & \nu = 1s - mp & . & . & m = 2, 3, 4 \dots \\ \text{I N.S.} & . & . & \nu = 2p - md & . & . & m = 3, 4, 5 \dots \\ \text{II N.S.} & . & . & \nu = 2p - ms & . & . & m = 2, 3, 4 \dots \\ \text{B.S.} & . & . & \nu = 3d - mb & . & . & m = 4, 5, 6 \dots \end{array} \right\} (1)$$

We next define how a single series term is represented quantitatively. As an abbreviative symbol we write (m, k) and (m, k, κ) respectively, and follow Rydberg or Ritz, according to the degree of accuracy required, by writing:

$$\left. \begin{array}{l} (m, k) = \frac{R}{(m + k)^2} \dots \dots \dots \text{Rydberg} \\ (m, k, \kappa) = \frac{R}{[m + k + \kappa(m, k, \kappa)]^2} \dots \dots \dots \text{Ritz} \end{array} \right\} (2)$$

R is the universal Rydberg-Ritz constant, which derives its name from this mode of representation in terms; k as well as κ denote the empirical parameters above indicated by s, p, d , which are characteristic of the element in question and of the series of that element under consideration. For $k = 0$, or $k = \kappa = 0$, respectively, both expressions for the terms pass over into the form that we know well from hydrogen:

$$(m, 0) = \frac{R}{m^2} \text{ (Balmer)} \dots \dots \dots (2a)$$

In Ritz's form the term is represented not explicitly, but implicitly, in that the term also occurs in the denominator of the expression, though only as a small correction involving also κ .

For k we must substitute in formulæ (2) the letter s in the terms of the II N.S., and the letters p, d, b for those of the H.S., the I N.S., and the B.S., respectively. Correspondingly, we write for the Ritz coefficient κ in these four term types the letters $\sigma, \pi, \delta, \beta$. It is noteworthy that the series constants s, p, d, b decrease in the case of every element in the order written (cf. in this connexion § 6, Table 43), likewise the Ritz constant $\sigma, \pi, \delta, \beta$. We may also express this in the following way. In

the scheme of series terms ms, mp, md, mb, \dots on page 316, the resemblance with hydrogen increases steadily as we proceed downwards. The l -terms are more hydrogen-like than the p -terms. The Bergmann terms are already to a marked extent hydrogen-like (cf. the note on p. 315); to a still higher degree are the x - and the y -terms hydrogen-like, as also the succeeding terms that have not been written down. According to eqn. (2a), the hydrogen character is fully attained when $k = \kappa = 0$.

In the foregoing remarks, we have departed from spectroscopic usage in that we have also written down the current number of the s -term as whole numbers. Usually they are set, not equal to ms , but to

$$(m + \frac{1}{2}, s) = 1.5s, 2.5s, 3.5s, \text{ etc.}$$

The reason for this is that in the case of the alkalis (and only in their case) the excess of the denominator of the term above the whole number m seems to approach the value $\frac{1}{2}$ so much the more, the smaller the atomic weight. For example, in the case of Na this excess is 0.65, for Li it is 0.59. Whether the subtraction of the amount $\frac{1}{2}$ is justified by theory is as yet undecided. We shall return to this point in the sequel (cf. § 2, Note to p. 329, and § 6 in the remarks connected with Table 63). In our description we shall also use the integral nomenclature ms for the s -term, that is, we shall suppose the amount $\frac{1}{2}$ taken up in the series parameter s . In using the halves the eqn. (1) for the H.S. and the II N.S. would have to be altered as follows:

$$\left. \begin{array}{ll} \text{H.S.} & \nu = 1.5s - mp \quad m = 2, 3, 4 \dots \\ \text{II N.S.} & \nu = 2p - (m + \frac{1}{2}, s) \quad m = 2, 3, 4 \dots \end{array} \right\} (3)$$

It is just this method of transcription that earlier seemed to justify the name "H.S. and II N.S. of hydrogen" for the He⁺-series (of Fowler and Pickering, cf. p. 207). If, namely, for the purpose of representing them we insert the special value $s = p = 0$ in the general definition (2) of the series term, then there arise from eqns. (3) exactly the eqns. (6) and (7) on page 207. But, on the other hand, as the series became reduced to the integral Balmer form, the eqns. (6a) and (7a) on page 208, the use of the halves has in general lost ground.

It must not be imagined that the combination of the lines into series and their resolution into two terms is a mere trifle. Rather it demands special experience and ingenuity. First of all, the lines of the various series are all mixed together and must be separated out in accordance with the criteria indicated at the beginning of this section. There are usually only a moderate number of lines of a single series present, as the higher members of the series, on account of their feeble intensity, are less accurate than the more intense lower members. To derive the series limit and hence the constant first term of the series by extrapolation, the analytical expression for the current term, for example in the Ritz

form, must be used as a basis. The series limit is then obtained, as well as the indeterminate parameters that occur in the series law (in general denoted in (2) by k, κ), by a graphical or arithmetical process of approximation.* It almost always appears that the first member (or members) of the series is not given with sufficient accuracy. From this we must conclude that not only Rydberg's but also Ritz's form represent only an approximation to the strict series law and are true only for the greater values of m . We shall see in the next section how the law is to be supplemented from the theoretical point of view, so as to be of service for smaller values of m . The task of calculating the series becomes much easier if other series or series limits of the same element are already known. On account of the relationships of "combination" (explained in the sequel) between the different series, we have always to strike a balance between the calculations of several series. It is unnecessary to emphasise that the wave-lengths measured are first reduced to measurements "in vacuo" and referred to normals, and that finally the wave-numbers must be expressed in international units.

In the representation (1) the following laws are contained, which historically preceded the description by terms and gave rise to it:—

1. *The series limits of the first and second subsidiary series coincide.* For, by (1), both occur at the wave-number $\nu = 2p$. The limit of the Bergmann series occurs at the wave-number $\nu = 3d$. As stated, these limits in most cases cannot be observed, but can only be calculated by extrapolation.

2. The series limit of the principal series has the wave-number $\nu = 1s$. *The difference between the wave-numbers of these series limits and of the common limit of the first and second subsidiary series is equal to the wave-number of the first member of the principal series (Rydberg-Schuster rule);* the second subsidiary series, too, if we extrapolate its expression in series for $m = 1$, leads to the same wave-number with the sign reversed.

So far we have tacitly spoken of *series of simple lines*. But frequently the series lines consist of several components; they are *doublets* or *triplets*, and in this respect, too, the elements that occur in the same column of the periodic system behave alike. This multiplicity of lines is due in the first place to the term of the principal series. On the other hand the term of the second subsidiary series is always simple. Also the term of the diffuse series has the same complexity as the term of the principal series, namely double or treble according as the term of the principal series consists of doublets or triplets (cf. § 5). But the separation of the components in the d -term is much smaller than in the b -term. For the *general* orientation of the series scheme with which we are for the present concerned, the multiplicity of the d -term and still more that of the b -term need not be taken into account. We indicate the multi-

* This process that has mainly been worked out by Paschen and his co-workers is described by E. Fues in his *Münchener Dissertation: Ann. d. Phys.*, **63**, 1 (1920).

plicity of the term of the principal series by considering mp in (1) replaced by :

$$mp_i \begin{cases} i = 1, 2 & \text{doublet series} \\ i = 1, 2, 3 & \text{triplet series.} \end{cases}$$

If we fix our attention on the lines with the same index i , we speak of a **Partial Series**. For the partial series contained in a doublet or a triplet series the following laws, which have been particularly useful in distinguishing principal and subsidiary series, hold :—

3. *For the first and the second subsidiary series the law of constant differences of frequency (difference of wave-number) hold.* That is: the doublet or triplet differences in the I and II N.S. have a difference $\Delta\nu$ (measured in wave-numbers), which is independent of the member number m of the lines and is identical in the I and II subsidiary series. Moreover, it coincides with the wave-number difference in the first member of the principal series. This follows immediately from the fact that the multiplicity of the subsidiary series is due to the *constant term* $2p_i$. In § 5 we shall illustrate in the case of I_i that this law is, on account of the additional multiplicity of the d -term, only a law of approximation in I N.S.

4. *The wave-number differences of the principal series decrease to zero as the member number increases.* The reason for this is that in this case the multiplicity is conditioned by the *variable* term, whereas the constant term is, strictly speaking, simple. For example, in a doublet series the difference in frequency of corresponding members of the two partial series $\Delta\nu = mp_2 - mp_1$ and this difference, according to (2), becomes smaller and smaller as m increases :

$$\Delta\nu = \frac{R}{(m + p_2)^2} - \frac{R}{(m + p_1)^2} = \frac{2R(p_1 - p_2)\left(m + \frac{p_1 + p_2}{2}\right)}{(m + p_1)^2(m + p_2)^2} \cong \frac{2R(p_1 - p_2)}{(m + p)^3} \quad (4)$$

where, in the denominator of the last expression, p is a mean value between p_1 and p_2 .

From (3) and (4) it follows, in particular, for series limits that :

5. *The partial series of a principal series approach, as the number of the member increases, one and the same series limit. The partial series of one and the same subsidiary series have series limits that differ from each other by the constant wave-number difference of the partial series in question ; but corresponding partial series of the first and second subsidiary series approach the same series limit as m increases.*

A further difference between principal series and subsidiary series follows from the intensity of the lines in the doublet and the triplet series.

We next consider the example of the D-lines, the first member of the principal series of the Na-spectrum already considered in Fig. 64 ; as is

well known, they form a doublet. The wave-length difference of the lines D_1 and D_2 amounts fairly accurately to 6\AA . D_2 is of shorter wave-length and more intense (twice as intense) as D_1 . This is to be interpreted in the sense that the number of Na-atoms that emit D_2 is greater than (twice as great as) the number of Na-atoms that emit D_1 ; cf. also § 5, eqn. (5). In Fig. 82 we show schematically, besides the lines D_1D_2 , also the next member of the principal series, in which the doublet interval is already markedly smaller, as also one of the succeeding members, in which the doublet no longer appears resolved. On the other hand, the type of the two subsidiary series is indicated in Fig. 82. By Law 3 their constant wave-number difference is equal to that in the first member of the principal series. The distances of the series members from one another, with which we are not at present concerned, have here (just as in the case of the principal series) been chosen arbitrarily in the scale of the ν 's. What are of essential interest to us at present are the conditions of intensity. In the subsidiary series the more intense component of the doublet is on the opposite side to that in the principal series. The reason

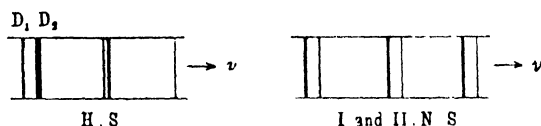

FIG. 82.

for this we see without difficulty by looking at the formulae (1) is that mp_i occurs in the expression for the principal series with the reverse sign to that of $2p_i$ in the expressions for the subsidiary series. We generalise this for arbitrary doublet and triplet series and enunciate our last proposition as follows:—

6. *The order of sequence of the intensities in the doublets and triplets of a principal series is the reverse of that in the corresponding doublets and triplets of a subsidiary series.*

For the rest, we have already in Chapter III, § 5, established the same fact with reference to the Röntgen spectra for the intensities of $K\alpha$, $K\alpha'$ and $L\alpha$, $L\beta$, as well as for those of $L\alpha$, $L\alpha'$ and $M\alpha$, $M\beta$. What was here called, in connexion with series representation, reversal of sign, appeared there, more vividly, as interchange of initial and final path in the one or the other pair of lines. Of course this interpretation may be taken over from Röntgen spectra and applied to the visible spectra.

As a comprehensive example of the preceding theorems we shall compare in Fig. 83 the line-spectra of potassium with one another; in the first row is the principal series, in the middle is the second subsidiary series, and in the bottom is the first subsidiary series. The lines have been drawn on the correct scale of their frequencies quantitatively; but we have magnified the doublet intervals ten times to make them per-

ceptible; the weaker doublet lines have throughout been drawn as dotted lines.

We see from the figure that the limits of the first and the subsidiary series coincide (Theorem 1), both the continuous and the dotted limits (Theorem 5). The limit of the principal series, diminished by the common limit of the first and second subsidiary series, gives the frequency of the first member of the principal series (Theorem 2, the Rydberg-Schuster Law; it is indicated for the continuous and dotted partial series by the continuous and dotted arrow). The doublet intervals are equal and constant in the two subsidiary series (Theorem 3); in the principal series they decrease rapidly towards the violet (Theorem 4.) That is why the limit of the principal series is simple, and that of the subsidiary series is double (Theorem 5). The order of sequence of the intensities of the doublet lines in the principal series is the reverse of that in the subsidiary series (Theorem 6).

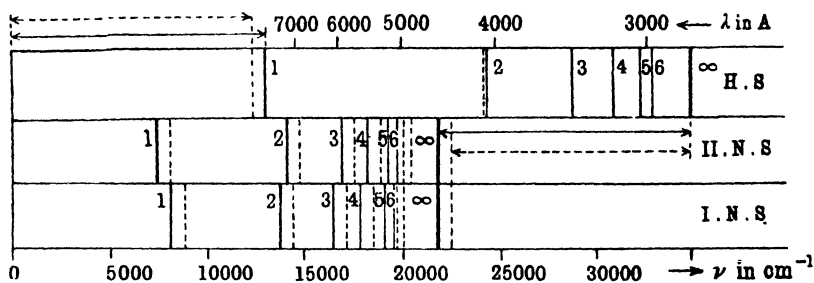

FIG. 83.

The spectra of the alkalis being easy to grasp first led to the arrangement of spectral lines into series and to the discovery of the relationships embodied in them. In the elements of the second and third column the character is much more manifold; here there are series types of simple lines, series types of doublets and triplets which in their turn again resolve into principal series, subsidiary series and Bergmann series. For a time it was therefore conjectured that the complete series scheme must consist of doublet, triplet, and simple lines. But this conjecture only helped to obscure the true state of affairs. For, as we shall see in § 6, the doublet series correspond to a state of ionisation of the atom other than that to which the simple series and the triplet series correspond, which belong together. Doublet series never occur in the same atom (in the same atomic state) in conjunction with triplet and simple series. In the last columns of the periodic system the number of lines and their character defies analysis, as we said above.

Besides the four series hitherto mentioned there are in the case of all elements numerous other combination lines and combination series. For example, we may combine the term $1s$ instead of $2s$ with the p -terms, or

Chapter VI. Series Spectra in General

$3p$ instead of $2p$ with the d -terms. In this way we arrive at a second representative of the H.S. or of the I N.S. type, which may be represented by formulæ analogous to (1):

$$\left. \begin{array}{l} \text{H.S.} \quad \nu = 2s - mp \quad m = 3, 4, 5 \dots \\ \text{I N.S.} \quad \nu = 3p - md \quad m = 4, 5, 6 \dots \end{array} \right\} \quad (5)$$

The following combination series are also often represented:

$$\left. \begin{array}{l} \nu = 3d - mp \quad m = 4, 5, 6 \dots \\ \nu = 4b - md \quad m = 5, 6, 7 \dots \end{array} \right\} \quad (6)$$

Ritz's Principle of Combination (p. 205) would even lead us to expect that we may combine every term ms , mp , mb , md with every other. But we shall see in the next paragraph that under normal conditions this principle is subject to selective limitations. We are already familiar from earlier remarks (p. 187) with the fact that it is *the terms and not the lines combined from them that constitute the true aim of spectroscopy*.

Helium (neutral helium, not He^+), the element which immediately succeeds hydrogen, already shows a very complicated series scheme that is in many ways very remarkable. It possesses two different series terms that do not combine with one another. We follow Bohr in calling the one **orthohelium**; to it belongs, for example, the intense yellow He-line, the Fraunhofer line D_3 for which $\lambda = 5876$, $\nu = 2p - 3d$. We call the other series system **parhelium**; it was originally ascribed to an element possibly different from helium. The series of orthohelium consist of very narrow double lines, the lines of parhelium are strictly simple.

We make use of the following "**scheme of levels**" ("*Niveauschema*"). Starting from the "energy-level zero" denoted by ∞ (an electron at an infinite distance from the atom) we plot the numerical value of each series term *downwards* and draw a step that is to visualise the term. Since the terms are proportional to the energy of the atom in the corresponding states of motion, each step denotes a possible energy-level of the atom—quite analogously to the earlier figures for the Röntgen region. We distinguish the steps as s -, p -, d -levels, drawn on the left for parhelium and on the left for orthohelium. It is found convenient to denote the levels of parhelium by capitals (S, P, D), those of orthohelium by small letters (s , p , d). This method of distinction agrees with the custom, introduced by Paschen, of characterising simple series with capitals, multiple series with small letters, wherever this is practicable. The two dense lines of separation in the middle of the figure indicate that direct transitions from the orthohelium levels to the parhelium levels are not admissible. We have omitted the series of b -terms and higher terms, as also the "doubleness" of the steps of orthohelium as, in any case, on account of their closeness, they cannot be made clear in the scale of the figure. The S-steps are numbered 1 to ∞ , the P-steps from 2 to ∞ , the D-steps from 3 to ∞ . The step $1s$ is present only once, namely, in the case

On the left of these there is drawn also the line

$$\lambda = 585, \quad \nu = 1S - 2S$$

we shall see in § 3 how these lines that lie far beyond the visible region may be measured.

There is a wide chasm between the levels 2S and 1S which is indicated in the figure by an interruption in the arrows. The distance (1S, 2S) is almost five times as great as the distance (2S, ∞), so that it could not be represented accurately to scale in the figure. Since the level 1s is missing in orthohelium, there is in its case no H.S. with the symbol 1s - $m\mu$. The main series with the symbol 2s - $m\mu$, 2S - mP are represented in both ortho- and parhelium. The majority of their lines lie in the visible region; only the first line of both series is in the infra-red, as is indicated by the shortness of the corresponding arrow. Their wave-lengths are:

$$\begin{aligned} \lambda &= 10830\text{\AA} \lesssim 1\mu, & \nu &= 2s - 2p \text{ (orthohelium),} \\ \lambda &= 20582\text{\AA} \lesssim 2\mu, & \nu &= 2S - 2P \text{ (parhelium).} \end{aligned}$$

The first, being the "resonance line" of helium (cf. § 3), is particularly interesting.

The levels with the same numerical coefficients, for example 2s, 2p, or 3s, 3p, 3d, have been joined together in the two halves of the figure to a continuous step-like line. As there is no level 2d or 2D, the first of these step-lines breaks off at 2p (2P), the second at 3d (3D); to the step-line 4s, 4p, 4d there would become added, if we had included the Bergmann series, the level 4b. The levels that have in this way been grouped together by means of the common current number m are actually uniform and correspond to one and the same Balmer term R/m^2 . It was partly to preserve these classifications or co-ordination that we departed somewhat in the foregoing from the usual nomenclature. The parhelium terms that are usually called 1.5S, 2.5S, 3.5S (cf. eqn. (3)) we have called 2S, 3S, 4S. Our ground-level 1S, which is inaccessible to ordinary spectroscopy, would be called 0.5S in the terminology which uses halves. Our figure may be regarded as a particular piece of evidence showing that the nomenclature of halves in the system of series is less well adapted than our nomenclature of whole numbers for the S- and s-terms.

Hitherto we have spoken only of *emission lines*. They result after previous excitation, that is, after the atom has been raised out of its naturally most stable state to one that is less stable (cf. p. 215), from which it in turn strives to escape into one that is again more stable. We call the most stable state of motion of the atom its **natural orbit** (ground orbit, German (*Grundbahn*)). The ground orbit thus corresponds to the *least energy* (algebraically), or what is the same, *the highest term*. In the case of neutral helium it is represented by the level 1S (or 0.5S in the ordinary nomenclature).

The *absorption lines*, on the other hand, so far as they arise in cold vapours, correspond to the unexcited natural state of the atom. The initial level of the absorption lines is therefore the "natural orbit" of the atom. In our diagram the absorption lines would have to be represented by arrows that start out from the natural or ground level and are directed *upwards*. Hence the lines of the H.S. type $1s - nP$, dotted in the figure, if inverted, therefore represent the absorption lines of cold He-gas and presumably (cf. § 3) the only absorption lines. The fact that they all lie in the extreme ultra-violet explains why He-gas is quite transparent in the visible region.

Clearly the position of the absorption spectrum is of fundamental importance for the knowledge of the series scheme. It makes us acquainted with the natural or ground orbit of the atom; it tells us that in the case of He the lowest level accessible to spectroscopy (here $2s$) cannot be the true natural or ground orbit.

§ 2. Quantum Theory of the Series Scheme. The Principle of Selection for the Azimuthal Quantum

The distinctive property of the hydrogen atom is, spectroscopically, that it exhibits only *one* series spectrum, namely Balmer's. The division into principal series and subsidiary series was here shown to be to no purpose. We saw the reason of this in the preceding chapter: the most general orbit of the hydrogen electron, the Kepler ellipse, when properly quantised leads to the same energy and the same spectral lines as the special circular orbits: the individual series term depends only on the *sum* of the azimuthal and radial quantum numbers $n + n'$, and not on these numbers separately. The same holds for the atoms He^+ and Li^{++} which are of the hydrogen type.

The case is different for atoms that are not of the hydrogen type; that is even for neutral He and Li. Here the pure Coulomb field with the nuclear charge Ze no longer reigns. We distinguish between an external "initial electron" (*Aufelektron*) which is thrown by some agency of thermal or electric origin out of its stable position into an orbit further removed from the nucleus, and the $Z - 1$ inner electrons which essentially describe their normal orbits ("essentially" means except for perturbations that arise from the respective position of the initial electron). This external initial electron moves in the field of the nucleus, which is screened off by the inner electrons. This field is still, indeed, asymptotically a Coulomb field: for sufficiently great distances the nuclear charge $+Ze$ and the $Z - 1$ electrons near the nucleus act conjointly like a simple point charge $+e$; but for moderate distances the individual distribution of the electrons near the nucleus enters as a factor. It produces a supplementary field that differs from the Coulomb field. The orbits of

But these are the same forms of the series terms, as those we enumerated in our note on the empirical laws of series in the preceding paragraph as the first, second, and third degree of development, namely, as the Balmer, Rydberg, and Ritz forms of the series term. *It is highly remarkable and satisfactory that these three types of spectral formulæ, which have been evolved slowly and laboriously, at widely distant times, from the data of observation, arise naturally and simultaneously out of our calculation.*

The theory also indicates in what direction we may expect a rational extension of the spectral formula. It arises when we retain in the expression for the potential energy higher (indeed, also even) powers of $\frac{1}{r}$, that is when we start from the most general form of central forces. The corresponding extended expression for the term then becomes :

$$(m, k \dots) = \frac{R}{[m+k+\kappa(\bar{m}, k \dots) + \kappa'(m, k \dots)^2 + \kappa''(\bar{m}, k \dots)^2 + \dots]} \quad (6)$$

The new series constants κ' , κ'' , that have here been introduced, are again independent of the radial quantum number n' and hence also of the current number $m = n + n'$, and they depend, besides on the constants of the atomic field, only on the azimuthal quantum number n . This is stated on the assumption that, *on the whole, the atom is neutral*, and that the main body of the atom, in the field of which the outer electron describes its orbits, has a surplus of a *single charge*. How the spectral formula is to be altered when the atom is *ionised* as a whole will be discussed in § 6.

And now there can no longer be a doubt as to how we must fit the hitherto separate principal series, subsidiary series, and so forth into our general scheme. In the principal series m assumes, by eqn. (1) on page 316, the values 2, 3, 4 . . . We shall assume that for all lines of the principal series the azimuthal quantum number n has the fixed value $n = 2$, whereas the radial quantum number may have all values $n' = 0, 1, 2 \dots$. This is equivalent to m assuming all the values 2, 3, 4 . . . To get into accord with the usual nomenclature we shall here write

$$k = \rho, \quad \kappa = \pi.$$

These quantities, being independent of n' , are characteristic constants of the principal series.

On the other hand, in the first subsidiary series, m assumes successively, by eqn. (1) on page 316, the values 3, 4, 5 . . . We shall assume that in the current term of the first subsidiary series the azimuthal quantum number n has the fixed value $n = 3$, whereas the radial quantum number may assume all numbers $n' = 0, 1, 2 \dots$; at the same time we shall write $k = d$, $\kappa = \delta$.

In the next section we shall see that the ideas which have been developed about the individual terms along these lines also fit in naturally

with the excitation conditions under which these series are found by experiment to come about. It is true that we are not yet in a position to calculate the series constants s , σ ; ρ , π , . . . *a priori* from the atomic models. The problem is, rather, the reverse, namely, to draw inferences from the observed series constants about the coefficients c in the development of the potential of the supplementary atomic field. But even this cannot be satisfactorily accomplished at present, because the coefficients c to be obtained in this way are incompatible with the assumptions (purely central supplementary field; electronic orbits lie only in the outer* regions of the atom), which are assumed as the basis of our problem in Note 13.

In spite of this the interpretation here obtained for the spectra which are unlike that of hydrogen is of value. It explains not only the separation of the one hydrogen series into the series systems that are observed in the case of all other elements, as well as the Rydberg and the Ritz form of representation of these series systems, but it also procures for us definite pictures of the phenomena when the principal series is emitted, or the first subsidiary series, etc. (cf. Fig. 85, that relates to the principal series). It is only in the first member of this series that the initial orbit is circular ($n = 2, n' = 0$); in the subsequent members the orbits assume an elliptic form of increasing eccentricity ($n = 2, n' = 1, 2, 3, \dots$). In the figure the orbits are drawn as exact

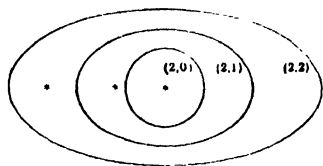

FIG. 85.

* The condition that the orbit of the migratory electron ("Aufelektron") lies entirely in the outer regions of the atom was tacitly assumed in our calculation of the terms in that we started with a uniform expression for the supplementary field; if the electron penetrates into the interior of the atom, the expression for the supplementary field would alter more or less discontinuously. Schrödinger has shown (*Zeitschr. für Phys.*, 4, 347 (1921)) that in the case of the s -term of the alkalis the migratory electron would have to pass through the s -shell, and he has taken this into account in the initial conditions for the supplementary field and the quantum conditions. He gets for the denominator of the s -term by his very schematic calculation the values:

$$m = 0.74 = 1.26; 2.26; 3.26; \dots$$

It immediately suggests itself that we may bring these fractional values into relationship with the multiples of halves occurring in the s -term (cf. p. 317), although the numerical values are widely different at present. Thus the fact that the s -term of the alkalis is an integral number of halves would accordingly be explained by the entrance of the migratory electron into the inner s -shell.

It is also noteworthy that in Schrödinger's result the lowest term-denominator, 1.26, corresponds, not to the value $m = 1$, but to $m = 2$. Schrödinger therefore assumes that the ground orbit of the alkalis is not a "circular orbit" ($n = 1, n' = 0$), but an "elliptic orbit" ($n = 1, n' = 1$), and accordingly designates it not by $1s$ but by $2s$. Thus the circular type of orbit which is the simplest of the series of s -orbits would thus be impossible dynamically and the series would begin with the simplest form of the elliptic type. Rojdestvensky, too, starting from a more formal point of view (comparison with the hydrogen spectrum), comes to the conclusion that the ground orbit of the alkalis is to be written as $2s$ and not as $1s$; cf. *Verhandl. des optischen Instituts in Petersburg*, Bd. II, Nr. 7, Berlin, 1921. Nevertheless, we consider it right for the present to keep to denomination $1s$ for the ground orbit, in particular in Fig. 86.

ellipses, whereas they are, in reality, deformed by the atomic field and their perihelions move. Furthermore, they have been drawn concentrically whereas they are in reality confocal (cf. the points indicated by small stars which denote the positions of the foci, which should in reality coincide). The orbits that form the basis of the term of the first subsidiary series are more extended (they have a great areal constant, $n = 3$) than those that condition the term of the principal series ($n = 2$), but they are otherwise similar to the latter. In the case of the term of the first subsidiary series the departure from the hydrogen type is less than in that of the term of the principal series; in that of the Bergmann term ($n = 4$) this departure is already so small that this term may from the outset be written down directly in Balmer's form. In the following terms* $m.r.$, $m.g.$ that correspond to the quantum numbers $n = 5$, $n = 6$, respectively, this is nowadays still adopted in the tables of Dunz, that is, these tables are written :

$$R \\ m^2, \quad m = 5, 6 \dots$$

We recognise in this a confirmation of the point of view set out at the beginning of this section, according to which every atomic field acts, at a sufficient distance from the nucleus, asymptotically as a Coulomb field and hence must produce a spectrum that is more and more closely related to Balmer's spectrum. Finally, the above reflections tell us that the Rydberg number R is a universal constant in the spectra of all elements and explain why it is so.

But we only see with certainty that we are right in ascribing the s -, p -, d -, b -terms to the azimuthal quantum numbers $n = 1, 2, 3, 4$ when we enlist the aid of our principle of selection (Chap. V, § 2). According to this, we have to expect only those combinations of the s -, p -, d -, b -terms in which the azimuthal quantum number differs only by unity.

If we write down the array of series terms in the order of increasing azimuthal quantum numbers :

$$\begin{array}{l} \text{II N.S.} \\ \left\{ \begin{array}{l} n = 1 \\ n = 2 \\ n = 3 \\ n = 4 \end{array} \right. \end{array} \quad \begin{array}{l} s\text{-term} \\ p\text{-} \\ d\text{-} \\ b\text{-} \end{array} \quad \begin{array}{l} \left\{ \begin{array}{l} \text{H.S.} \\ \text{I N.S.} \\ \text{B.S.} \end{array} \right. \end{array}$$

The arrows at the immediate right of the terms denote those transitions from an initial to a final state, in which the azimuthal quantum number decreases by 1 ($n_a - n_r = +1$); those on the left denote transitions in which the azimuthal quantum number increases by 1 ($n_a - n_r = -1$).

For example, the principal series arises through the transition at the right-hand top corner, corresponding to its symbolic expression

$$\nu = 1s - np, \quad m = 2, 3, 4 \dots$$

* A detailed special study of these terms has been carried out by Rojdestvensky, cf. *Verhandl. des optischen Instituts in Petersburg*, Nr. 8, Berlin, 1921.

Its characteristic feature is the combination of the p -term ($n_a = 2$) with the s -term ($n_s = 1$); the amount of the number m , which is, according to our view, determined by the radial quantum number ($m = n + n'$, and in the present case, $m = 2 + n'$), remains arbitrary. It is clear that our principle of selection also allows the series

$$\nu = 2s - mp, \quad \nu = 3s - mp \dots$$

which likewise correspond to the transition from $n_a = 2$ to $n_a = 1$. Its occurrence was discussed in eqn. (5) of the preceding section and again specially in Fig. 84 for the case of helium. The fact that it is in general weaker than the true principal series $\nu = 1s - mp$ is easily explained on the ground that here the number m must in general be greater than 2 to give rise to a positive ν , that is, to make possible a process of emission accompanied by loss of energy.

The first subsidiary series is characterised by the transition, at the centre of the second column to the right, which corresponds to the series formula

$$\nu = 2p - md, \quad m = 3, 4, 5 \dots$$

In it the essential feature is the combination of the p -term with the d -term ($n_s = 2$ and $n_a = 3$); instead of $2p$ there might also be, according to our principle of selection, $3p$ or $4p$; in either of these cases, however, the minimum value of m would have to be raised beyond 3, and this would entail a weakening of the corresponding lines. Such transitions have actually been observed, even if less often than the lines of the first subsidiary series in the narrower sense (cf. eqn. (5) on p. 322).

The lowest arrow on the right leads to the following symbol for the Bergmann series

$$\nu = 3d - mb, \quad m = 4, 5, 6 \dots$$

or, in addition, to the Bergmann series of higher order

$$\nu = 4d - mb, \quad m = 5, 6, 7 \dots$$

The combinations of the terms mx , my also fit in well with the principle of selection. According to Dunz, the following combinations occur in the case of the alkalies, of He, and other elements:

$$4b - 5x, \quad 5x - 6y$$

which are written by him, on account of their similarity with the hydrogen series (cf. p. 330), thus:

$$4\Delta p - \frac{N}{5^2}, \quad \frac{N}{5^2} - \frac{N}{6^2}$$

(where Δp and N take the place of b and R respectively).

These combinations exactly realise the quantum transitions here to be expected, $n_a = 5$, $n_s = 4$ and $n_a = 6$, $n_s = 5$ respectively, which would link up on the right with our scheme.

Whereas the series $4b - m.r$ ordinarily lie in the infra-red region, and hence mostly escape observation, they become displaced into the visible region in the case of spark spectra (cf. § 6). Fowler* has discovered a series of this kind, consisting of many lines, in the spark spectrum of Mg, but has described it by the expression $4b - mb$, which is in contradiction with the principle of selection. This interpretation is possible as an approximation only because the terms $m.r$ are only very slightly different from the terms mb (and both differ only slightly from the Balmer terms). Nevertheless, Fowler is compelled in his interpretation to talk of "inexact combinations" between mb and $4b$. The correct interpretation of $4b - m.r$ has been brought out clearly by Rojdestvensky (cf. p. 330); in it the infringement against the principle of selection, as also that against the principle of combination, vanishes.

We now pass on to consider the left-hand side of our scheme. Here the top arrow belongs to the second subsidiary series (II N.S.). It is represented by :

$$\nu = 2p - ms, \quad m = 2, 3, 4 \dots$$

For a corresponding increase in the minimum value of m , we may again write $3p, 4p, \dots$ in place of $2p$.

The two lower arrows on the left lead to series that have been observed in the case Na, for example, and that have the form of eqn. (6) in § 1. They are, corresponding to the higher minimum values of m necessary in this case, rarer and weaker than the better known series previously discussed.

Recapitulating we state: *The combinations which our principle of selection allows in the first place lead to the most commonly occurring and most intense series (Principal Series, First and Second Subsidiary Series, Bergmann Series). Reasonable grounds may be adduced for the more infrequent occurrence of the combinations allowed by our principle. We may regard the above statement as confirming the allocation of the various series terms to the azimuthal quantum number n , and we may regard it as convincing evidence of the truth of the principle of selection.*

But there are also exceptions to the principle of selection; these include transitions in which the azimuthal quantum remains unaltered ($n \rightarrow n$), and also such in which it changes by more than one unit ($n \rightarrow n - 2$). Concerning this, investigations by J. Stark† and his collaborators are particularly instructive. They show in the case of neutral helium that anomalous series of this kind are invisible under

* Phil. Trans., **214A**, 225 (1914).

† J. Stark. Neue im elektrischem Felde erscheinende Hauptserien des Heliums. G. Liebert, Der Effekt des Elektrischen Feldes auf ultraviolette Linien des Heliums. G. Liebert, Eine neue Heliumserie unter der Wirkung des elektrischen Feldes. O. Hardtke, Über die Bedingungen für die Emission der Spektren des Stickstoffs, Ann. d. Phys., **56**, 577, 589, 610, 633 (1918).

ordinary conditions of discharge and are called up only when strong electric fields are applied.

The series in question are (in the notation corresponding to Fig. 84):

$$\left. \begin{array}{lll} \text{III N.S.} & \nu = 2p - mp & m = 3, 4, 5 \\ \text{" Diffuse " H.S.} & \nu = 2s - md & m = 3, 4, 5 \\ \text{" Sharp " H.S.} & \nu = 2s - ms & m = 3, 4, 5 \end{array} \right\} \quad (7)$$

The expression "Third Subsidiary Series (III N.S.)" is due to Lenard, who first observed it in the alkalis. The two other expressions have been suggested by Stark, but have not been happily chosen. The series formulæ themselves characterise the true state of things more clearly and exhaustively than such expressions. The first and the third series are examples of the transition $n \rightarrow n$; the second is an example of the transition $n \rightarrow n - 2$. In our scheme on page 330 the series belonging to the transition $d \rightarrow s$ is represented by the dotted arrow at the top on the right. Isolated lines of this series have also been observed occasionally in other elements (cf. Dunz for the cases, K, Rb, Tl, Ca, Ba). Indeed, Foote, Meggers, and Mohler* find that when the current density is particularly high the line $1s - 3d$ in the spectrum of Na and K surpasses all the other lines in intensity. Furthermore, there are combinations, that have been variously measured, between the b - and the p -term (in the cases, Li, Na, K, Al, Tl, Zn, Cu, Ag) which likewise contradict the principle of selection; they are denoted in our scheme on page 330 by the dotted arrow at the bottom on the right. On account of the lack of definiteness of the conditions of excitation it is quite possible that in these cases, too, intensities of field due to condensed discharges may have played a part. We may refer also to Paschen's inclusion of the He^+ -line $\lambda = 4686$ in the "spark current" (cf. Chap. VIII, § 4), which depicts in a particularly convincing fashion the occurrence of component lines in the electric field that are otherwise inadmissible.

In Chapter V, § 2, the principle of selection was specially derived for emission in the absence of fields; in Chapter V, § 3, it was shown that it is rendered invalid by intense electric fields. This case is proved to occur experimentally in the experiments of Stark, Foote-Meggers-Mohler, and Paschen, and accounts, without artificiality, for the other occasional exceptions to the principle.

The considerations of the preceding chapter at the same time shed light on the true meaning of our azimuthal quantum number n (cf. footnote 1 on page 326). That which is transported by the radiation and is fixed in integral numbers by a quantum condition is the *total moment of momentum of the atom*, not that of an outer electron. The principle of selection, as a deduction from the principle of emission, in proving itself to be the deciding factor for the s -, p -, d -, b -terms, indicates that the

* The results are in course of publication.

quantum number n that distinguishes these terms, and that was, to begin with, ascribed in our theoretical treatment of the series scheme to the outer electron, must be closely related to the rotatory *motion of the whole electronic system of the atom*. Further details on this point will be found in the appendix to § 7.

Konen, in his book, "Das Leuchten der Gase und Dämpfe," has appended to his account of the principle of combination a criticism of this same principle, in which he calls attention to the comparatively infrequent occurrence of many of the combinations possible according to it. In contradistinction to this, we see here that all those combinations that are indicated by the principle of selection and by our interpretation of the series terms actually occur, and are the rule, and that we have no reason to be surprised at the absence of certain combinations, but rather at the isolated occurrence of anomalous combinations. But the latter, too, are also consonant with the sense of our principle since, in agreement with the observations in the case of He and He⁺, they are produced in Na and K exactly under the conditions that theory leads us to expect.

Thus the principle of selection forms a necessary supplementary limitation to the principle of combination; it restricts the boundlessness of the former and raises its practical value. We oppose to Ritz's form of the principle of combination, namely, *every series term can be combined with any other to form a spectral line*, the more precise form: *every series term can normally be combined with any other of which the azimuthal quantum number differs from that of the first by one unit; combinations which overstep this limitation are not essentially excluded, but they require special conditions of excitation*.

Just as we concluded the preceding section by a description of the series scheme of He, so we shall conclude the present one by considering the particularly lucid and typical series scheme of the alkalis. Corresponding to their true physical definition, the terms will again be depicted as energy-steps or energy-levels; the scale used corresponds to sodium. The steps furthest to the left belong to the s -terms, those next on the right to the p -terms, then those to the d -terms, and so forth. The numbers (1, 2, 3, . . . on the left) written next to the energy-steps denote the quantum sums (azimuthal quantum number + radial quantum number), so that, for example, the succession of steps 3 comprises the terms $3s$, $3p$, $3d$. Corresponding to the actual behaviour of the terms, the height of the steps in the upper levels gradually decreases till at the step ∞ , corresponding to the zero-level of the energy when the electron under consideration is infinitely distant from the atom, the height vanishes entirely, that is, becomes zero. The transitions from one level to a lower level are characterised by arrows, and represent the lines of the H.S., the I N.S., and so forth. Not only $1s - 2p$, but also $2s - mp$ is designated as H.S. The D-line is represented by the arrow $1s - 2p$

on the left. We could not in the figure take account of the two-foldness of the p -level, so that the two components D_1 and D_2 are represented by the same arrow. In contradistinction to Fig. 84, the "ground orbit" $1s$ is optically accessible in the case of the alkalis (cf. the conclusion of the preceding section). For the lines $1s - mp$ of the H.S., among them above all the D-lines, appear in cold Na-vapour as strong absorption lines, and thereby indicate that we have before us in the optical level $1s$ the true ground orbit for the natural state of the Na-atom; the same is true of the alkalis generally. The absorption spectrum of Na-vapour has already been depicted in Fig. 64. The principle of selection comes into action in the present figure in that all the arrows combine respectively only two such levels as are neighbouring in the sequence s, p, d, b ; it is a particular consequence of this that to draw the arrows it was only

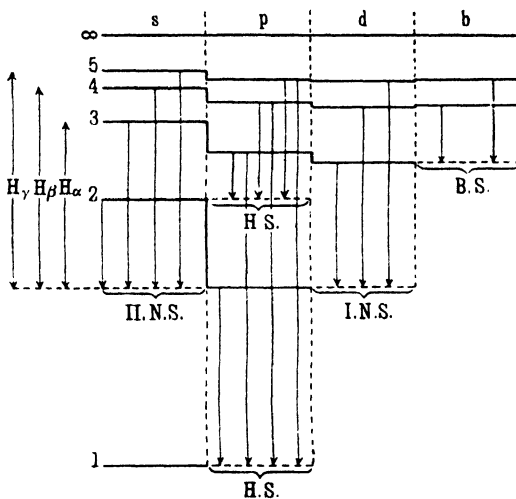

FIG. 86.

necessary to continue (as a dotted line) each level to the series of terms that follow directly on the right or on the left.

Further, we use our figure to make clear the relations between the spectra unlike the hydrogen type to the hydrogen type itself. The transition to the hydrogen spectrum is effected (see p. 317) by setting all the series constants, $s, \sigma; p, \pi \dots$ equal to zero. The series of levels of the quantum sums, $2, 3, 4 \dots$, that appear as steps in our Fig. 86, thereby become stretched into straight lines (or approximately straight lines, if we take account of the fine-structure, Chapter VIII). The transitions between the scheme of levels simplified in this way are the Balmer lines, as is indicated on the left side of the figure.

Scheme I, shown below, shows in detail how the various lines of the general series scheme are assigned to the various kinds of origin of the Balmer lines (cf. p. 238). We have already remarked on page 270 that

the principle of selection considerably reduces the originally enumerated possible modes of production of the Balmer lines. Our Scheme I now shows that according to the principle of selection there are for *each* Balmer line *only three possible modes of production*, which are represented by the quantum sum $n + n'$ of the final and the initial orbit. To these three possible modes of production there correspond three lines of the general series scheme, being indeed one of the H.S., one of the I N.S., and one of the II N.S. This comparison of our two pictures brings out particularly clearly how *the lines that coincide in the case of hydrogen* (or that are close together in the picture which includes the fine-structure) *become dissociated into lines of the general scheme of the series that may even be wide apart.*

SCHEME I

$$\begin{array}{l}
 H_{\alpha} \left\{ \begin{array}{ll} 2 + 0 \leftarrow 3 + 0 & 2p - 3d \quad \text{I N.S.} \\ 2 + 0 \leftarrow 1 + 2 & 2p - 3s \quad \text{II N.S.} \\ 1 + 1 \leftarrow 2 + 1 & 2s - 3p \quad \text{H.S.} \end{array} \right. \\
 H_{\beta} \left\{ \begin{array}{ll} 2 + 0 \leftarrow 3 + 1 & 2p - 4d \quad \text{I N.S.} \\ 2 + 0 \leftarrow 1 + 3 & 2p - 4s \quad \text{II N.S.} \\ 1 + 1 \leftarrow 2 + 2 & 2s - 4p \quad \text{H.S.} \end{array} \right. \\
 H_{\gamma} \left\{ \begin{array}{ll} 2 + 0 \leftarrow 3 + 2 & 2p - 5d \quad \text{I N.S.} \\ 2 + 0 \leftarrow 1 + 4 & 2p - 5s \quad \text{II N.S.} \\ 1 + 1 \leftarrow 2 + 3 & 2s - 5p \quad \text{H.S.} \end{array} \right.
 \end{array}$$

SCHEME II

$$\begin{array}{l}
 \text{H.S.} \left\{ \begin{array}{ll} 1s - 2p & Ly \\ 1s - 3p & \text{,,} \\ 1s - 4p & \text{,,} \\ 1s - 5p & \text{,,} \\ \dots & \dots \end{array} \right. \left| \begin{array}{ll} 2s - 3p & H_{\alpha} \\ 2s - 4p & H_{\beta} \\ 2s - 5p & H_{\gamma} \\ \dots & \dots \end{array} \right. \left| \begin{array}{ll} 3s - 4p & \text{Pa-Ri-Fow} \\ 3s - 5p & \text{,,} \\ \dots & \dots \end{array} \right. \\
 \text{I N.S.} \left\{ \begin{array}{ll} 2p - 3d & H_{\alpha} \\ 2p - 4d & H_{\beta} \\ 2p - 5d & H_{\gamma} \\ \dots & \dots \end{array} \right. \left| \begin{array}{ll} 3p - 4d & \text{Pa-Ri-Fow} \\ 3p - 5d & \text{,,} \\ \dots & \dots \end{array} \right. \left| \begin{array}{ll} 4p - 5d & \text{Pi} \\ \dots & \dots \end{array} \right. \\
 \text{II N.S.} \left\{ \begin{array}{ll} 2p - 3s & H_{\alpha} \\ 2p - 4s & H_{\beta} \\ 2p - 5s & H_{\gamma} \\ \dots & \dots \end{array} \right. \left| \begin{array}{ll} 3p - 4s & \text{Pa-Ri-Fow} \\ 3p - 5s & \text{,,} \\ \dots & \dots \end{array} \right. \left| \begin{array}{ll} 4p - 5s & \text{Pi} \\ \dots & \dots \end{array} \right. \\
 \text{B.S.} \left\{ \begin{array}{ll} 3d - 4b & \text{Pa-Ri-Fow} \\ 3d - 5b & \text{,,} \\ \dots & \dots \end{array} \right. \left| \begin{array}{ll} 4d - 5b & \text{Pi} \\ \dots & \dots \end{array} \right. \\
 \text{K.S.} \left\{ \begin{array}{ll} 3d - 4p & \text{Pa-Ri-Fow} \\ \dots & \dots \end{array} \right. \left| \begin{array}{ll} \dots & \dots \end{array} \right.
 \end{array}$$

In Scheme II the arrangement is reversed: the hydrogen lines have been set down on the right next to the corresponding various types of series (H.S., I N.S., II N.S., B.S.; K.S. = combination series) and these are the hydrogen lines into which these series resolve when the atomic field becomes vanishingly small. Here $L\gamma$ denotes a line of the ultra-violet Lyman series (cf. p. 207); Pa-Ri denotes a line of the infra-red series observed by Paschen after having been calculated by Ritz; the same series occurs in ionised helium as Fowler's series, and has been denoted by the abbreviation Fow. Again, Pi points to the Pickering series of ionised helium, the analogous series of which for hydrogen would lie in the extreme infra-red and has not been observed.

From Scheme II as well as from Scheme I we read that *each* of the Balmer lines corresponds to *three* different lines of the general series scheme, and in the same way the Paschen-Ritz or the Fowler lines, respectively, each correspond to *five* different lines. The latter number is brought into striking evidence, as we shall see in § 4 of the final chapter, by Paschen's observations of Fowler's series.

§ 3. Testing the Series Scheme by the Method of Electronic Impact

The most direct test of Bohr's ideas, the one that is most free of theoretical elements, is the method of electronic impact.* It was initiated by Franck and Hertz † in 1913 and during the war it was developed in the United States particularly. At present it is being brought to a greater and greater pitch of perfection by Franck and his followers and is being applied to finer and finer problems.

The first investigations of Franck and Hertz were concerned with the question of the elastic collisions between electrons on the one hand and gaseous atoms or molecules on the other hand. In the final arrangement of 1914, electrons enter into the space occupied by gas and here acquire a certain velocity through a potential drop that may be finely regulated. (According to eqn. (1) on page 8, the measure of this drop in volts may at once be used as a measure of the velocity.) After finally traversing a small constant retarding potential the electrons fall on to an electrode and flow through a galvanometer to earth. In the case of inert gases and, in general, of such gases as have no electron-affinity (N_2 or vapours of electropositive metals) the galvanometer indicates, when the potential is gradually raised in the gas chamber, a gradual increase of the current passing to earth, but then a sharp limit occurs, which marks the first occurrence of inelastic collisions, that is, of collisions that are accompanied by loss of energy and that entail a change of constitution

* Details are given in: Franck and Hertz, *Phys. Zeitschr.*, **20**, 122 (1919); Franck, *ibid.*, **22**, 358 (1921); W. Gerlach, *Die experimentellen Grundlagen der Quantentheorie*. Sammlung Vieweg, Braunschweig, 1921.

† *Verh. d. D. Phys. Ges.*, **15**, 34, 373, 613, 929; **16**, 12, 457, 512 (1911); **18**, 213 (1916).

in the structure of the atom or molecule struck. This first maximum in the potential-current curve is followed by other maxima or kinks, which occur at regular intervals, showing that the electrons, after having lost their velocities in a first inelastic encounter have for a second or third time, owing to their further passage through the potential drop, attained a velocity that once again permits them to lose their energy in inelastic collisions. The distance between such successive bends of the curve measures in volts the energy that was transferred to the atom during the inelastic collision, that is, determines a characteristic constant of the atom struck.

In the case of the Hg-atom the first inelastic collision obtained in this way was given by 4.9 volts. Moreover, Franck and Hertz were at once able to give the spectroscopic interpretation of this number. For they observed that at a potential of 4.9 volts the Hg-line $\lambda = 2537$ flashed up, and they were able to show that the related $h\nu$ corresponded exactly to the energy due to 4.9 volts. In the same way, in the case of He the first inelastic collision occurred at 20.5 volts; for Ne it was at 16 volts, and for A it was at 12 volts.

Lenard* must be mentioned as the predecessor of Franck and Hertz in the production and measurement of slow electronic velocities. The rather qualitative observations of Gehecke and Seeliger† (alteration of the average colouring of the luminescence of gases as the velocity of the exciting cathode rays is varied) also preceded the decisive experiments of Franck and Hertz.

The original method was later elaborated in manifold ways. Instead of allowing the electrons to acquire their velocities whilst incurring many elastic encounters with gas molecules, it is preferable for many purposes to accelerate them along a distance that is less than their mean free path (that is, to use a low pressure). The electrons that have been endowed with the desired velocity in this way are then allowed to enter into the actual collision chamber, which is essentially free of fields, and the size of which is made large and offers opportunity for a sufficient number of collisions with the gas particles under examination. Finally, the electrons are completely debarred from making all further progress, owing to the agency of a stronger opposing field. Thus they do not reach the measuring electrode connected with the galvanometer at all. Rather, what are measured by the galvanometer are the positive ions that are formed, whether directly or indirectly, by the primary electrons during the inelastic collisions. Positive ions are produced *directly* if the velocity of the electrons is sufficient to *ionise* the atoms struck. They are produced *indirectly* if the transferred energy, although not able to eject an electron right out of the atomic configuration, yet suffices to raise one of the electrons belonging to the atom out of its natural orbit into one that

* Heidelberg Akad. Abh., Nr. 34 (1911); Nr. 17 (1914).

† Verh. d. D. Phys. Ges., 14, 335 (1912).

is richer in energy. When the electron belonging to the atom returns from this new orbit to one that is poorer in energy (nearer the nucleus), it emits light; in atoms that are more easily ionisable, which belong to the struck electron or which, under certain circumstances, are mixed as impurities with the gas under examination, this light acts photo-electrically and thus also produces positive charges that make themselves observed in the current which flows through the galvanometer.

To discriminate between these two effects, namely, the direct ionisation effect and the indirect photo-electric effect, was a matter of great experimental importance. Bohr* was the first to call attention to the possibility of this indirect effect and showed numerically that it probably occurred in Franck and Hertz's deduction of the values 4.9 volts for Hg, and 20.5 volts for He. Davis and Goucher† succeeded in carrying out experimentally the unambiguous differentiation between the original ionisation and the photo-electric effect by means of an ingenious arrangement and connexion of fields for the case of Hg, and thereby fully confirmed Bohr's point of view. We cannot here enter into the details of the method and of the manifold improvements which have been made to it in the sequel, but must refer the reader to the reports quoted at the beginning of the chapter. There, too, will be found the interesting and much varied forms of the current-voltage curves and their discontinuities.

In addition to the *purely electrical method*, in which electrical devices are used not only to excite but also to observe the effect of the excitation by means of a galvanometer, there is also a more *optical method* in which the occurrence of the various emissions of light is investigated by means of a spectrograph. Rau‡ has obtained noteworthy results. He found, particularly in the case of the lines of neutral He, that to excite successive members the excitation voltage had to be increased from line to line. This furnishes a quite general and decisive confirmation of Bohr's series scheme: *the higher members of a series require higher energy levels, and hence higher excitation voltages become necessary*. At the same time, this is a general refutation of all the older theories of series that regarded the higher members as, in some sense, overtones of the lower members, and that sought to find a mechanical connexion between their emission and that of the lower ones. While this fact holds within one and the same series, another circumstance is of no less importance for us; it is concerned with a comparison of the excitation voltages of lines of different series: *the requisite excitation voltages increase in the sequence H.S., I N.S., and, as we may with reason add, B.S.* The H.S. appears first, that is at the smallest excitation; the first subsidiary series is obtained with greater difficulty, and the Bergmann series is obtained with the greatest difficulty, and hence was the last to

* Phil. Mag., 30, 394 (1915), § 3.

† Phys. Rev., 10, 101 (1917); 13, 1 (1919).

‡ Würzburger phys.-med. Gesellsch., 1914, p. 20.

be found. This corresponds exactly with our views developed in the last section. Actually, the most important factor for the excitation of a series is the realisation of the corresponding initial orbits that correspond to the *second* series term. This is the p -term in the case of principal series, the d -term in the first subsidiary series, and the b -term in the Bergmann series. According as the realisation of these initial orbits require smaller or greater amounts of energy, the series may be excited with less or with greater ease. If we compare, in particular, the initial orbit in the first members of each series with each other, then the energy-level $2p$ lies below the energy-level $3d$, and this in turn below $4b$. Hence the order H.S., I N.S., B.S., follows. The position of the *second* subsidiary series exhibits singularities as regards its excitation. In general, the second subsidiary series occurs simultaneously with the principal series; indeed, in the case of He, it occurs, according to measurements of Ritz perhaps in part even earlier than the latter. This, too, may be interpreted by considering the relative position of the s - and the p -levels in Fig. 84.

Before passing on to the proper quantitative results of the method of electronic collisions, we wish to give the transformation formula which, by means of the $h\nu$ -relation, leads us from the wave-length λ of a spectral line to the voltage necessary to excite it. It is clearly:

$$h \cdot c/\lambda = e \cdot V.$$

If we here express V in volts, that is, set $V \cdot 10^8$ in place of the potential difference V initially considered measured in electromagnetic C.G.S. units, and if, further, we use for e the value $1.59 \cdot 10^{-20}$ (that is, electromagnetic C.G.S. units), and measure λ , instead of in cms., in terms of $\mu = 10^{-4}$ cms., we get

$$V \text{ (volts)} \times \lambda(\mu) = \frac{h \cdot c}{e} \cdot 10^{-4} = 1.234 \quad . \quad . \quad (1)$$

Ladenburg* has called attention to the particular convenience of using this formula.

For example, if we calculate the excitation potential corresponding to the Hg-line $\lambda = 2537 \text{ \AA} = 0.2537 \mu$, and to the D-line of Na, $\lambda = 5890 \text{ \AA} = 0.589 \mu$, we get by (1), respectively,

$$V = \frac{1.234}{0.254} = 4.9 \text{ volts}, \quad V = \frac{1.234}{0.589} = 2.1 \text{ volts} \quad . \quad (1a)$$

Let us, on the other hand, calculate the excitation potentials corresponding to the series limits to which these two series belong. The series limits are given as limits of the values of terms in cm.^{-1} . Now, since

$$\nu = \frac{1}{\lambda(\text{cms.})} = \frac{10^4}{\lambda(\mu)}$$

it follows from (1) that

$$V \text{ (volts)} = 1.234 \cdot 10^{-4} \nu \quad . \quad . \quad . \quad (2)$$

* Zeitschr. f. Elektrochemie, 1920, p. 265.

From the spectroscopic tables (Dunz) we read off that the limit of the principal series (see below) to which the Hg-line 2537 belongs is $\nu = 84177$; for the principal series of sodium it is $\nu = 41445$. Hence from (2) it follows, respectively, that

$$V = 1.234 \cdot 8.418 = 10.39, \quad V = 1.234 \cdot 4.145 = 5.11 \text{ volts} \quad (2a)$$

We call the last two potentials the **ionisation potentials** of the initially neutral Hg- or Na-atom. For, just as the series limit is a measure of the energy that is liberated when the electron makes a transition from infinity, so the corresponding potential in volts is a measure of the energy that must be used up to remove the electron to infinity. Thereby we assume that the final orbit of the spectral process (the initial orbit of the ionisation process) is actually the ground orbit of the neutral atom. For example, in the case of the neutral He, we should certainly not, from the conditions represented in Fig. 84, calculate its ionisation voltage from the limit of the visible principal series, as in this case the final orbit of the principal series (called $2s$ by us) lies far above the ground orbit, in the energy scale.

But we use for the two numbers in volts calculated in (1a) the now customary term **resonance potential**, which we interpret as meaning the following. If the work done in the electronic collision does not, indeed, suffice to bring about ionisation, it may yet suffice to lift an electron out of its ground orbit $1s$ into the ("energetically") next highest orbit $2p$.* The atom that has been excited in this way will, if left to itself, tend to return to the stable configuration of the ground orbit, thus causing the emission of monochromatic light. For, according to the principle of selection, the transition $2p \rightarrow 1s$ will be possible for it, and it is the *only* way in which the excited atom can revert to its unexcited state. In this process the *whole* energy V that is given to the atom by the colliding electron will be emitted as monochromatic radiation of wave-length λ equivalent, by eqn. (1), to V . This re-emission of the whole transferred energy is called resonance (linking up with the old views of the theory of vibrations); hence we get the expressions **resonance line** and **resonance potential**. The conception of resonance line thus implies two things: first, that its final orbit is the ground orbit of the atom, and second, that its initial orbit is the (energetically) next highest orbit from which the return to the ground orbit, and only to this, is possible, being accompanied by the emission of monochromatic light.

* In the case of the Earths Al, In, Tl, which exhibit pronounced doublet series, the greatest s -term spectroscopically accessible is *smaller* than the term $2p$ (more accurately, than the two doublet terms $2p_1$ and $2p_2$, p. 319). Hence, if there is no greater s -term inaccessible to ordinary spectroscopy, then $2p$, and not $1s$, would be the ground orbit of these atoms. We should expect as the absorption lines in cold vapour the lines of the II N.S. $2p - ms$ (not those of the H.S. $1s - mp$), and as a resonance line the transition $1s \rightarrow 2p$ (instead of the transition $2p \rightarrow 1s$). The best method of deciding the existence or non-existence of a possibly deeper, spectroscopically inaccessible, s -orbit is that of electronic collisions. In the case of Tl a start has already been made with this method by Foote and Mohler; cf. Phil. Mag., **37**, 33 (1919).

Only in the case of the hydrogen atom, in which we have definite theoretical knowledge of the ionisation potential or the resonance potential of the various lines, is it possible to evaluate eqn. (2) without having recourse to empirical data. Even in the case of H_2 and He^+ it is necessary to adjoin an empirical number to be able to draw other purely theoretical conclusions.

In the case of H the ionisation voltage is determined by the limit of the Lyman series, that is, by Rydberg's number R. By eqn. (2), we get, therefore, in volts :

$$V = 1.234 \cdot 10^9 \cdot 68 = 13.53 \text{ volts} \quad . \quad . \quad . \quad (3)$$

In ergs it is given by the formula, identical with the latter,

$$-W = h\nu_\infty = h \cdot R = 2.15 \cdot 10^{-11} \text{ ergs} \quad . \quad . \quad . \quad (3a)$$

Here ν_∞ denotes the limiting frequency and R the Rydberg frequency, both measured in sec.^{-1} . If we here also wish to measure ν_α and R as wave-numbers in cms.^{-1} , we must in (3a) write $\nu_\alpha c$ and Rc instead of ν_α and R. The symbol $-W$ is used to indicate that this same quantity, except for its sign, at the same time represents *the total energy of the hydrogen atom in its ground orbit*, that is, the energy that is liberated when the electron, coming out of a position infinitely distant (energy-level zero), in which its energy is irrelevant, is entrapped by the nucleus, and passes over into the state of motion defined by the ground orbit (energy-level $-W$).

We pass on from (3) to the excitation potentials (*Anregungsspannungen*) of the Lyman and the Balmer lines. For the first line of the Lyman series (cf. p. 207)

$$\nu = R \left(\frac{1}{1^2} - \frac{1}{2^2} \right), \quad \lambda = 1215.7 \text{ \AA}$$

we get, since its wave-number amounts to $\frac{3}{4}$ of that of the series limit, $\frac{3}{4}$ of the ionisation potential, thus

$$V = \frac{3}{4} \cdot 13.53 = 10.15 \text{ volts} \quad . \quad . \quad . \quad (3b)$$

But for the first line of the Balmer series we do not get, as its ν -value might lead us to think, $5/36$ of the ionisation potential, but rather, it must be noted, that when the atom is in its natural state, that is in its ground orbit, the electron must first be raised from its ground orbit into the 2-quantum orbit and *then* into the 3-quantum initial orbit of the line H_α . In this way the excitation potential for H_α comes out equal to that of the second line of the Lyman series, that of H_β equal to the third Lyman line, and so forth. Thus we get

$$\begin{array}{ll} \text{for } H_\alpha & \nu = \frac{5}{36} \cdot 13.53 = 12.03 \\ \text{for } H_\beta & \nu = \frac{15}{8} \cdot 13.53 = 12.68, \text{ etc.} \end{array}$$

We have purposely refrained from using for the potential (3b) of the first Lyman line the name resonance potential which immediately sug-

gests itself. It is true that with the excitation of 10.15 volts the hydrogen atom would tend towards its ground orbit with the re-emission of monochromatic radiation corresponding to the amount of energy which it had previously received. But this process does not quite correspond with the experimental conditions present in a true resonance phenomenon. For in actual experiments the initial state of the hydrogen is not the H-atom but the H₂-molecule. The latter must first be resolved into H-atoms by the addition of heat of dissociation or of the potential of dissociation. We know this quantity from observation, but cannot check it with theory as we do not know the model of H₂ exactly. The dissociation potential amounts in volts fairly accurately to

$$D = 3.5 \text{ volts} \quad . \quad . \quad . \quad . \quad . \quad (4)$$

The ionisation potential would have to be increased by this amount if it is to be referred to the hydrogen molecule as the initial state in experiments, and likewise the excitation potential above calculated. Thus we get

$$\left. \begin{aligned} 13.5 + 3.5 &= 17.0 \text{ volts for the ionisation potential} \\ 10.2 + 3.5 &= 13.7 \text{ volts for the excitation potential of } \lambda = 1216\text{\AA} \\ 12.0 + 3.5 &= 15.5 \text{ volts for the excitation potential of } H_{\alpha}, \text{ etc.} \end{aligned} \right\} \quad (4a)$$

all these quantities having been calculated from the state of the H₂-molecule. The total energy of the H₂-molecule becomes, if we use the empirical value $D = 3.5$ in an analogous manner to the first line of (4a),

$$-W = 3.5 + 13.5 + 13.5 = 30.5 \text{ volts} \quad . \quad . \quad . \quad (4b)$$

For if we wish to determine the total energy involved in the relative positions and motions of two H-nuclei and two electrons, we may proceed by resolving the whole system into its components. This is done as indicated in (4b), by dissociating the molecule into its two atoms and then ionising each atom separately.

We postpone the treatment of the difficult question of the ionisation potential of the H₂-molecule necessary for forming a positive H₂⁺-ion till Note 14 at the conclusion of the book. In spite of the extraordinary amount of experimental and theoretical work that has been devoted to it this question still seems not quite cleared up. Here we shall just mention only two points of particular interest.

(a) It is not possible to dissociate the hydrogen molecule by a mere electronic collision of 3.5 volts. Therefore, in the current-potential curves plotted for H₂-gas no bend, that is, no inelastic action of any sort, occurs at the point $V = 3.5$ volts. Rather, dissociation occurs only in conjunction with ionisation or excitation of at least one of the two H-atoms formed as a result of the dissociation, that is not before one of the potentials given in (4a) is reached. The reason for this must be furnished by the dynamics of electronic collision, which we do not yet know.

(b) In the current-potential curves of H_2 -gas we find a pronounced energy-step at about 11 volts, which used to be ascribed to the formation of H_2^+ -ions. According to Franck this interpretation is no longer tenable, but rather it is probable that at 11 volts a characteristic ultra-violet band-spectrum is excited (corresponding to a wave-length of about 100\AA) which bears the same relation to the visible band-spectrum of the H_2 -molecule, the many-lines spectrum ("*Viellinienspektrum*"), as the Lyman series to the Balmer series in the H-atom.

Just as in the case of the H_2 -molecule we obtained the value 3.5 volts, so in that of the He^+ -atom we must know its energy of formation from the neutral atom empirically, that is, from observation, if we wish to draw further conclusions based on the likeness of He^+ to hydrogen. This energy of formation is identical with the ionisation energy of the neutral He-atom and will be denoted by I. Interesting considerations connected with models arise from the value of I; these are described in Note 14. According to many accurately carried out measurements $I = 25.3$ volts. We may now write down, for example, the second order ionisation potential of He. It is

$$I + 4 \cdot 13.5 = 79.3 \text{ volts} \quad (5)$$

Actually, to deprive the hydrogen-like atom He^+ of its electron, we require work four times as great as in the case of the H-atom. As shown by the formula, this follows at once from the factor Z^2 in the He-series; in more pictorial language, we may say that one factor 2 arises out of the doubled nuclear charge of He^+ as compared with H, and the other factor 2 from the halved distance of the electron from the nucleus as compared with that in the case of H. In the curves given by the observations of Franck and Kuipping,* as well as in those of F. Horton,† an ionisation step occurs at 79.5 ± 0.3 and 80 volts respectively, which clearly corresponds to the tearing off of *both* electrons of the He-atom in *one* elementary act. Formula (5) gives, at the same time, the total energy - W of the neutral helium atom.

We pass on to the excitation potential of the line

$$\nu = 4R \left(\frac{1}{3^2} - \frac{1}{4^2} \right), \quad \lambda = 4686\text{\AA}$$

by removing the electrons of the He^+ -ion not to infinity but only as far as the 4-quantum orbit, the initial orbit of 4686. The work necessary for this is

$$4Rch \left(1 - \frac{1}{4^2} \right) = \frac{15}{16} \cdot 4 \cdot 13.5 = 50.1 \text{ volts.}$$

Thus if we start from the neutral state of the He-atom the excitation voltage of 4686 comes out as

$$I + 50.1 = 75.4 \text{ volts} \quad (5a)$$

* Phys. Zeitschr., 20, 481 (1919),

† Proc. Roy. Soc., 95, 408 (1920).

Actually, this line occurred in the experiments of Rau mentioned at potentials lying between 75 and 80 volts, in that at 75 volts no trace of the line appeared but at 80 volts it was present with full intensity.

We now come to the metallic vapours, firstly to the alkalis which are distinguished by the simplicity of the scheme giving their series. The final orbit of the H.S. is here at the same time the ground orbit (cf. § 2, p. 335); the principal series therefore appears as an absorption series in the cold vapour. The first line of the H.S. (in the case of Na, this is the D-line) is at the same time a resonance line, and its excitation potential may straightway be calculated, by eqn. (1), from its wave-length known from optical observations. The potential so determined leads to the first inelastic collision. As a rule, the second inelastic collision after this first one is found to be the ionisation limit. In this process there occurs in the stream of positive atomic ions the possibility of the re-combination into neutral atoms with the emission of some member of the H.S. Accordingly, optical observation of the process of excitations distinguishes between three stages: (a) below the resonance potential there is no emission; (b) after this potential has been exceeded we get the ground line of the H.S. ("one-line spectrum," *Einiinienspektrum*); (c) above the ionisation potential the whole H.S. ("the more-lines spectrum," *Mehrliinienspektrum*) appears. Special precautions are necessary to call up only one part of the lines of the H.S.

How perfectly observation and calculation agree even quantitatively is shown in the following Table 36. In the column under "obs." (observed) the values of the resonance and ionisation potentials measured

TABLE 36
Alkalis

	Resonance potential in volts		Resonance line in Å-units	Ionisation potential in volts		Series limit in cm.⁻¹	Observer
	Obs.	Calc.		Obs.	Calc.		
Li . . .	—	1.84	6708	—	5.36	43,485	—
Na . . .	2.13	2.092	5896	5.13	5.11	41,445	
K . . .	1.55	1.602	7699	4.1	4.32	35,006	} Tate and Foote, Phil. Mag., 36, 75, (1918)
		1.609	7664				
Rb . . .	1.6	1.55	7948	4.1	4.15	33,685	
		1.58	7800				
Cs . . .	1.48	1.38	8943	3.9	3.87	31,407	} Foote, Rognley, and Mohler, Phys. Rev., 13, 59 (1919)
		1.45	8521				

by the method of electronic collisions, and under "calc." (calculated) the values obtained for the same quantities from the optical data by eqns. (1) or (2), respectively, are given. The optical data themselves are tabulated under the headings "resonance line" and "series limit." Whereas

the limit $1s$ of the principal series is simple, the resonance line $1s - 2p_i$, $i = 1, 2$, is double, but separated by so small an interval that it must appear simple in electronic collision. In passing we must note that the position of the series limit is given by numbers regularly decreasing as the atomic number increases. (In the resonance line that is compounded from the difference of two terms this regularity (cf. Li) is a little obscured.) This and the correspondingly proportional decrease of the ionisation potential denotes at the same time a weakening of the electro-positive character of the alkalis as the atomic number increases, and this may be explained by the parallel increase of the ionic size (cf., for example, Fig. 26).

The conditions are much more involved in the case of divalent metallic vapours. Here, as already mentioned (p. 321; further details in § 5), there occur a series system of triplet lines and one of lines of a simple structure, which combine among themselves. The former are denoted by the symbols s, p_i, d_i, \dots ($i = 1, 2, 3$), the latter by the symbols S, P, D, \dots . In the case of these vapours excitation by means of electronic collisions was first investigated by McLennan and Henderson* and led to the just now mentioned differentiation between the "one-line spectrum" (in the *above* sense, not in the sense of the symbols S, P, D) and of the "more-lines spectrum." But the whole matter became cleared up through the work of Davis and Goucher (cf. p. 347) on the excitation of Hg-vapour. The interest was here centred in the resonance line of mercury $\lambda = 2537$, which we have already mentioned several times; the fact that it is, at the same time, the ground line of the absorption spectrum shows that its final orbit also represents the ground orbit in the Hg-atom. We call its term $1S$ (in Paschen's nomenclature it is usually called $1\cdot5S$). As Paschen has shown,† $\lambda = 2537$ is a combination line of the system of simple and triplet lines. It has the formula,

$$\nu = \frac{1}{\lambda} = 1S - 2p_2$$

both terms are defined with perfect accuracy from our knowledge of the triplet and the simple lines series. For we have

$$1S = 84177, \quad 2p_2 = 44767$$

and so we get the resolution

$$\nu = 39410 = 84177 - 44767.$$

Since, in the process of emission, the first term (we discard the sign) determines the energy of the final orbit, and the second term determines that of the initial orbit, we write at the lowest energy-level of Fig. 87 the number, - 84177, and at the next lowest the number, - 44767. It is

* Proc. Roy. Soc., **91**, 485 (1915) and a series of continuations of this paper.

† Ann. d. Phys., **35**, 876 (1911).

between these two levels that both the process of emission (arrow downwards) as well as that of absorption (arrow upwards) take place.

In addition, we consider the line $\lambda = 1849\text{\AA}$ situated still further in the ultra-violet. As it likewise occurs not only as an emission line but also as an absorption line in cold mercury vapour, it must start out from or, respectively, tend towards the same ground level, the natural orbit of the electron at the periphery of the atom. This is confirmed by its expression in terms. For, according to Paschen (*loc. cit.*), $\lambda = 1849$ is the line of the principal series of simple lines and is therefore expressed by the formula,

$$\nu = \frac{1}{\lambda} = 1S - 2P$$

in which $2P = 30111$, and we have the resolution

$$\nu = 54066 = 84177 - 30111.$$

In accordance with this we have therefore to add in Fig. 87, above the two energy-levels hitherto considered, one that is higher and to which we assign the number -30111 .

The emission and the absorption of $\lambda = 1849$ then takes place between this upper level and the lowest level, and they are indicated by oppositely directed arrows. Above this upper level there has been drawn in the figure a still higher top level, which denotes the removal of the electron to

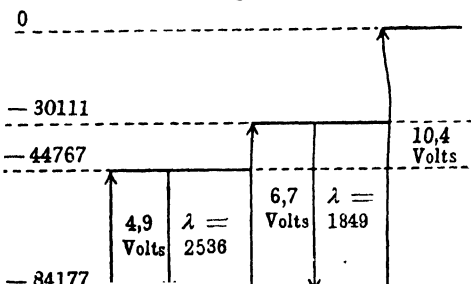

FIG. 87.

infinity and represents the energy 0. According to eqn. (2) the following numbers of volts correspond to the above-mentioned wave-numbers :

$\nu = 84177$	$V = 10.4$ volts.
$= 54066$	$= 6.7$ „
$= 39410$	$= 4.9$ „

Actually, Davis and Goucher have confirmed that at the value 4.9 volts given by Franck and Hertz (cf. p. 338) the line $\lambda = 2537$ is flashed out. At the same time, however, they succeeded in proving that an ionisation of Hg-vapour did not yet occur at this potential. Furthermore, they detected signs of the emission of the line $\lambda = 1849$, likewise without ionisation, when the potential was 6.7 volts. *Ionisation was shown beyond doubt to occur at a potential of 10.4 volts.*

But these circumstances are exactly repeated in the case of all elements of the second column of the periodic table. In all cases, $1S - 2p_2$ is the first excitation limit, $1S - 2P$ the second, and $1S$ itself the ionisation potential. How completely the measurements obtained

from electronic collisions agree with spectroscopic data is shown in Table 37. The values tabulated under "calc." have here, too, been determined from eqns. (1) and (2).

TABLE 37
Alkaline Earths

	Excitation potential in volts		1S - 2p ₂ 1S - 2P	Ionisation potential in volts.		Series limit in cm. -1	Observer
	Obs.	Calc.		Obs.	Calc.	1S	
Mg . . .	2.65 4.42	2.7 4.33	4572.65 2853.06	7.75; 8.0	7.61	61,663	Foote and Mohler, <i>Phil. Mag.</i> , 37 , 33 (1919). Mohler, Foote and Meggers, <i>Journ. Opt. Soc. Amer.</i> , 4 , 364 (1920). Bur. of Stand., Nr. 403, 1920.
Ca . . .	1.90 2.85	1.88 2.92	6574.59 4227.9	6.01	6.09	49,309	Mohler, Foote and Stimson, Bur. of Stand. Nr. 368, 1920; <i>Phys. Rev.</i> , 14 , 534 (1920).
Sr	—	1.79 2.68	6894.45 4608.61	—	5.67	45,935	—
Ba	—	1.56 2.23	7913.52 5537.04	—	5.19	42,030	—
Zn . .	4.1; 4.18 5.65	1.01 5.77	3076.88 2139.33	9.3; 9.5	9.35	75,759	Tate and Foote, <i>Phil. Mag.</i> , 36 , 64 (1918). Mohler, Foote and Meggers, l.c.
Cd . .	3.88; 3.95 5.35	3.78 5.39	3262.09 2288.79	8.92	8.95	72,533	As for Zn.
Hg . . .	4.9; 4.76 6.7; 6.45	4.86 6.67	2537.48 1849.6	10.38; 10.2	10.39	84,178	Franck and Hertz, l.c. Franck and Einsporn, l.c. Mohler, Foote and Meggers, l.c.

In addition to these results very detailed measurements carried out in the case of mercury in particular by Franck and Einsporn* have brought into evidence a whole series of higher energy-levels, for example, 1S - 3P, 1S - 4P, 1S - 3p₂, 1S - 4p₂, in the current potential curves. It is of particular interest that the transitions

$$1S - 2p_1 \quad \text{and} \quad 1S - 2p_3$$

that are not observed optically and that are excluded by a selective principle governing the inner quantum numbers (cf. § 5) make themselves noticeable in the current-potential curves as bends. It occurs to us immediately that the principle of selection, by the mode of its deduction (cf. p. 269), restricts only the phenomena of monochromatic emission, not the effects of electronic collisions.

The ionisation potential of the second order, that is the formation of a double positive ion has also been determined by Foote, Meggers, and Mohler† for the alkaline earths, the first being Mg. This ionisation potential of the second order corresponds to the H.S. limit of the doublet

* *Zeitschr. f. Phys.*, **2**, 8 (1920).

† *Phys. Rev.*, **18**, 128 (1921).

lines of the spark, just as the ordinary ionisation potential corresponds to the limit of the H.S. simple lines, and, of course, lies considerably higher than the latter (15 volts as compared with 7.6 volts, in the case of Mg). It is of particular interest as it is a measure of the "*Wärmelönung*" (sum of the heat generated in a chemical reaction and the external work performed) in the chemical union of divalent ions.

It is also of interest that it was possible to find the ionisation potential of Pb^* by electronic collisions, that is of an element whose series system is still quite obscure. In this quarter a way seems open to introduce order into the line-relations of Pb, after the limit of its H.S. has been found.

Excitation experiments have also furnished valuable knowledge about neutral helium. In the first place a decision was required concerning the question of its atomic model. Bohr's model (Fig. 19) with its two electrons revolving at the ends of a diameter would require an ionisation potential $I = 28.7$ volts, as we shall calculate in Note 14. But observation led to $I = 25.3$ (cf. eqn. (5) above, or the following Table 38). Thus *Bohr's model had to be rejected*.

Then the ground level of helium, 1S in Fig. 84, had to be found. It already follows from the fact that helium gas is quite transparent as far down as the ultra-violet that this level is not identical with the final orbit of the visible H.S., namely, 2S or 2s (as on p. 322, the capitals refer to "parhelium," and the small letters to "orthohelium"). A positive datum for the position of the ground level is the measurement of the first inelastic collision at 20.5 volts by Franck and Hertz (cf. p. 338). If we express the limit of the H.S. of orthohelium $\nu = 38453$ in terms of volts by eqn. (2), we get $1.23 \cdot 3.85 = 4.75$ volts; and by adding this to 20.5, we get 25.25 volts, that is the ionisation potential of neutral He. From this we see that the *ground level 1S lies 20.5 volts lower than the final level of the H.S. of orthohelium*, the formula of which we write as $\nu = 2s - mp$ (in the usual notation $\nu = 1.5s - mp$).

The first inelastic collision of 20.5 volts (20.45 volts according to Franck and Knipping†) is therefore to be interpreted as

$$20.45 \text{ volts} = 1S - 2s.$$

Following Franck, we call this the **transformation potential** ("*Umwandlungsspannung*"). The slightly higher step, which is clearly distinguishable from 20.45 in the current-potential curves of Franck and Knipping, is

$$21.25 \text{ volts} = 1S - 2s.$$

The difference

$$21.25 - 20.45 = 0.80 = 2s - 2S$$

corresponds exactly to the difference of the limits of the optical H.S. of orthohelium and parhelium.

* Mohler, Foote and Stimson, Bureau of Standards, Nr. 368, 1920.

† Physik. Zeitschr., 20, 481 (1919); Zeitschr. f. Phys., 1, 320 (1920).

These conditions have already been exhibited graphically in Fig. 84; on the right side of the figure we see the compounding of the ionisation potential out of the transformation potential 20.45 and the H.S. limit of orthohelium; on the left side we see how it is compounded of the energy-level 21.25 and of the H.S. limit of parhelium.

TABLE 38

Observed	Calculated *	Series name	Wave-lengths
20.45	—	1S - 2s	610 ⁰
21.25	21.25	1S - 2S	585
21.9	21.85	1S - 2P	569
23.6	23.7	1S - 3P	523
25.3	25.23	1S	493

The next steps may be read from Table 38, and have also been drawn in Fig. 84 on the left as dotted arrows. They correspond to the ultra-violet H.S. of parhelium that tends to the ground orbit: it must at the same time be the absorption series of unexcited He. The wave-lengths given in Table 38, in particular that corresponding to the transformation potential, $\lambda = 610$, have only been calculated. Only the wave-length 585 \AA has been observed optically by Lyman and Fricke †; as it has the formula 1S - 2S it is an exception to the principle of selection, and is presumably to be expected only in intense electric fields. It is just for this reason that, in the Lyman-Fricke arrangement, it escapes absorption in the case of neutral helium, whereas, on the other hand, the lines 1S - 2P, 1S - 3P, which one would expect first, optically, are presumably again extinguished by absorption.

That there is no level 1s of orthohelium corresponding to the level 1s of parhelium is rendered certain by the facts above stated. This circumstance also explains the distinctive position taken up in the series system of He by 2s (it is indicated in Fig. 84 by the darkening of the level 2s). For, once this state has been excited, it cannot again be destroyed by monochromatic emission. It is therefore called the **metastable** state by Franck and Reiche. ‡ The term "transformation potential" applied to the 20.45 volts points to the transformation from the stable state 1S to the metastable state 2s. In this connexion the remark of Franck is interesting that the transformation 1S \rightarrow 2s occurs only in impure He: in perfectly pure samples of the gas the transformation potential 1S - 2s vanishes entirely from the current-potential curve.

The level 2S has also a certain degree of stability inasmuch as the transition 2S \rightarrow 1S which, from the energy view, is alone possible here

* Obtained by adding to 20.45 volts the amounts of energy that follow from the series scheme.

† Phil. Mag., **41**, 814 (1921).

‡ Zeitschr. f. Phys., **21**, 635 (1920).

is excluded by the principle of selection: at any rate $2S$ is not unstable to the same degree as, say, $2P$, $3P$, But nevertheless the stability of $2S$ is much less than that of $2s$, because in the case of $2s$ there becomes added to the restrictions imposed by the *principle of selection* the evidently much more effective "partition" restriction (imposed by the fact that the levels of ortho- and parahelium may not be combined). Consequently, the level $2S$ is not, as in the case of $2s$, called metastable; corresponding to this, the level $2s$ but not $2S$ in our Fig. 84 has been emphasised by being darkened and thus made comparable to the ground level $1S$.

At the same time the particular position of $2s$ explains the character of the line $\lambda = 10830\text{\AA} \cong 1\mu$ as a "resonance line." From the initial state $2p$ the He-atom can pass over only to $2s$, whilst the transition to $2S$ or $1S$ is excluded owing to our central partition in Fig. 84. Herein the line $2s - 2p$ is distinct from the line $2S - 2P$, $\lambda = 20582 \cong 2\mu$. From the initial state $2S$ there is possible the transition to $2S$ as well as to $1S$. Actually, according to an investigation by Paschen,* $\lambda = 2\mu$ exhibits incomplete resonance, but $\lambda = 1\mu$ complete resonance. This means that if helium gas receives radiation $\lambda = 1\mu$, it re-emits all the absorbed light as light of the same wave-length, whereas, if it receives radiation $\lambda = 2\mu$, it radiates out only a fraction of the absorbed light as light of the same wave-length. The fact that in each case a certain excitation of the He-gas was necessary to provoke absorption, is in accordance with the circumstance that neither $2s$ nor $2S$ is the ground orbit of the unexcited He.

We have described here, of course, only those results of the method of electronic impact that are particularly instructive and immediately intelligible. Over and above this, the method bids fair to shed light on unknown series relationships (cf. also the conclusion of the next paragraph).

Finally, we shall add for the sake of contrast with the excitation by means of electronic impact a method of purely optical excitation. It has been developed by Füchtbauer † for Hg-vapour. In exhibiting its results we shall follow Füchtbauer in using a diagram that was first used by Bohr ‡ and that is particularly appropriate for representing the complicated conditions here involved. In this diagram the various atomic states are not represented by horizontal levels but by points which, according to their series character are disposed along different horizontal lines. The difference between the energy-values of two atomic states are accordingly not denoted by a vertical arrow but by the *horizontal projection* of an arrow, which connects the points of the initial state with those of the final state. In this diagram lines to the left signify absorption, those to the right signify emission, and owing to the principle of selection they will always be in an oblique direction. The distances of the horizontals, denoted by

* Ann. d. Phys., **45**, 625 (1914).

† Physik. Zeitschr., **21**, 635 (1920).

‡ Zeitschr. f. Phys., **2**, 434 (1920). Cf. also W. Grotrian, Physik. Zeitschr., **21**, 638 (1920).

s, p_i, S, P, D , from one another are chosen arbitrarily, but the positions of the points marked 1, 2, 3, . . . on these horizontals are drawn according to scale, their distances from the bounding line on the left of the figure give directly the values of the corresponding terms.

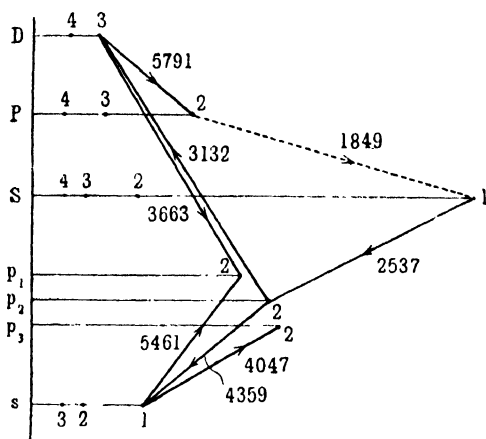

FIG. 88.

initially, since the Hg-vapour is in the state given by the ground orbit $1S$; but, owing to the absorption, a fraction of its atoms, cf. Fig. 88, pass into the state $2p_2$. Hence this fraction is enabled to emit not only the line $1S - 2p_2$ but also to absorb the lines

$$2p_2 - 1s, \quad \lambda = 4359; \quad 2p_2 - 3D, \quad \lambda = 3132$$

(as, indeed, all lines of the type $2p_2 - X$, for which $2p_2$ is the initial level of the absorption). In this way new atomic states $3D$ and $1s$ (the latter is usually called $1\cdot5s$) come about. From these as starting points the following emissions are possible according to the principle of selection:

$$2P - 3D, \quad \lambda = 5791; \quad 2p_1 - 1s, \quad \lambda = 5461$$

$$2p_3 - 1s, \quad \lambda = 4047.$$

These and further emission* lines have been photographed by Füchtbauer as secondary and tertiary consequences of the primary illumination by the radiation 2537\AA . Füchtbauer showed that 2537 was actually the only primary excitation active by causing the line 2537 to be absorbed by the interposition of a thin film of glass; this led to the cessation of the emission of light of longer wave-length.

It is fascinating to observe how the light that was initially ultra-violet in its zig-zag diagrammatic course, which may be considerably multiplied

* For example, the lines of the I N.S., $2p_i - 3d_j$, $2p_i - 4d_j$, that are not drawn in the figure were very intense on the photographs. Füchtbauer kindly informed me in a letter that he had identified thirty-one lines, some being very intense, others less intense.

§ 4. Continuous Transition: Röntgen Series to Visible Spectra 353

in the figure, becomes more and more divided up into branches of visible light. We have also indicated by a dotted line in the figure the possibility of getting ultra-violet light of still shorter wave-length than the original 2537 light (the necessary energy in quanta is furnished by the absorption of light of longer wave-lengths that has occurred in the meantime). We need merely connect $2P \rightarrow 1S$ to close our polygon, thus obtaining in $\nu = 1S - 2P$, $\lambda = 1849$, an emission that is of shorter wave-length than the primary light $\lambda = 2537$. This emission was certainly present in Füchtbauer's experiment although the constructional limits of the apparatus did not allow it to be observed.

Füchtbauer's experiments are also instructive in that they bring into evidence the finite "time of stay" of atoms* in their excited states. Actually there is, for example in the state $2p_2$, a finite probability that a further energy quantum will link up with $2p_2$ only if the atom persists in the state $2p_2$ for a finite time.

There is the following fundamental difference between excitation by electronic collision and excitation by means of vibrational energy. The kinetic energy of the impinging electron may be greater and need not be exactly equal to the amount that the atom requires for the transition to the excited state; any excess beyond this amount remains as energy of motion of the electron. On the other hand, in the excitation by means of light radiation of frequency ν the quantum $h\nu$ must be exactly equal to the energy-step of the transition to be excited. Light of a greater ν is just as ineffective as light of a smaller ν . It is only when the transition leads to the dissociation of the atomic configuration, that is to ionisation, that a greater ν is also effective. Only in this case is the amount by which its $h\nu$ exceeds that necessary for ionisation imparted to the detached electron as "photo-electric" energy of motion.

§ 4. Continuous Transition from the Röntgen Series to the Visible Spectra

Whereas in the early stages of electromagnetic optics chief interest was centred in the problem of bridging over the region between Hertzian waves and heat waves, that is, between wave-lengths of about 1 metre to 1 microm., the experimenter now finds himself confronted with the task of filling the gap that exists between the optical region, and the Röntgen (X-ray) region. If we count the optical region, including the extreme Schumann rays, as stretching to, say, 1200Å and the Röntgen region that is accessible to crystal analysis as extending to 12Å, then the gap, expressed in terms of volts by means of eqn. (1) on page 8, extends from about 10 volts to 1000 volts. The limits of the region between $\lambda = 1200\text{Å}$ and $\lambda = 12\text{Å}$ correspond to the fundamental proper radiation $K\alpha$ of H on the one hand and of Na on the other; accordingly

* In Chapter VII, § 3, we shall draw a similar conclusion from certain observations of band-spectra.

there are accumulated in the middle of the region the lines and bands of selective absorption of the atoms C, N, and O, which can hardly be omitted entirely from the course of optical radiation. It is clear that just this region must present very great difficulties to the optical method. We therefore expect the most important disclosures about this intermediate region from the method of electronic impact which has, indeed, already fixed the characteristic fundamental points of the region (see below, 20 volts for He, 16 volts for Ne, and 12 volts for A). Furthermore, Foote and Mohler have succeeded in tracing the L-series* for example

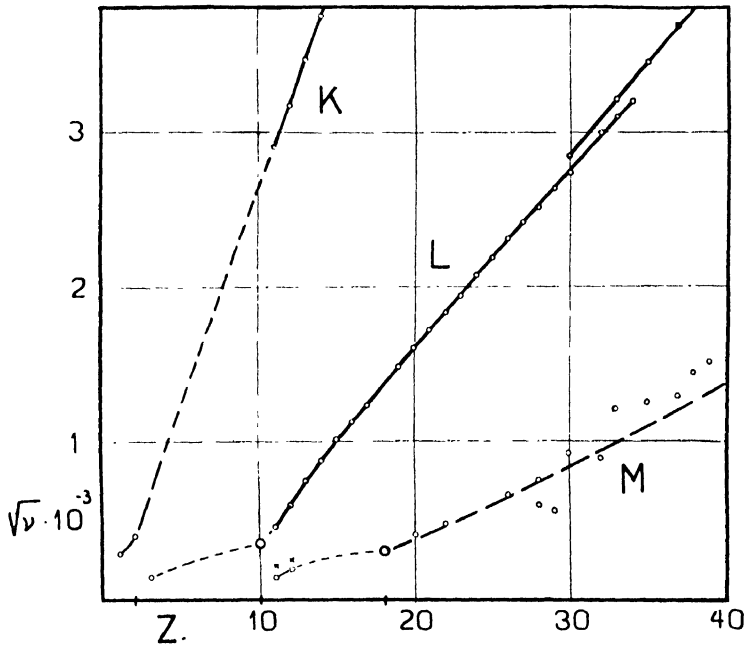

FIG. 89.

as far down as Ne. The fact that the optical method of the grating (cf. p. 161) is competing at the same time and is being elaborated gives us ground to expect that the gap still present will soon be bridged.

By extrapolating boldly and using the numerical values at present available, Kossel has continued to map out even at this early stage the general lines of connexion between Röntgen spectra and visible spectra. We proceed to describe his instructive diagram† given in Fig. 89. The horizontal axis gives the atomic numbers of the lower elements, whereas,

* Journ. Opt. Soc. Ann., Vol. 5, July, 1921.

† Zeitschr. f. Phys., 2, 470 (1920). Experiments in the extreme ultraviolet now allow us also to check Kossel's figure empirically. Cf. Millikan, National Academy, 7, 289, 1921, where, for example, the L α -line is given for the elements Al to Li. Kossel's predictions have hereby been confirmed in every detail.

following Moseley's example, Kossel plots along the vertical axis the square root of the frequency number of the principal line of each Röntgen series; the root is chosen in preference to the frequency itself because of its rectilinear course and the greater ease of extrapolation.

The line $K\alpha$ has been observed as far as Na, for which $Z = 11$, and its graph may be extended without uncertainty as far as to He. Here it ends exactly at the ultra-violet absorption line of He, which corresponds to the removal of one of the two He-electrons from the ground orbit 1S to the quantum orbit 2P; we see from Table 38 on page 350 that its wavelength is $\lambda = 569\text{\AA}$, which corresponds to an excitation potential of 21.9 volts. This He-line is followed at once by the first line of the Lyman series, which has already been described on page 226 as the analogous line to the $K\alpha$ -line for hydrogen. Its position is made certain by Balmer's formula.

Only the upper part of the graph of L, as far as $Z_n = 30$, has been constructed from direct measurements of $L\alpha$. But for smaller values of Z its course may be found with sufficient accuracy for our present purpose from the values of the combination of $K\beta$ and $K\alpha$ by calculating from the formula: $L\alpha = K\beta - K\alpha$ (to be read in terms of wave-numbers) which is approximately but not accurately true. The small difference in height between the initial upper and the later lower course of the L-line denotes the so-called "combination-defect" $\Delta = K\beta - K\alpha - L\alpha$ (cf. Chap. VIII, § 6, where it is explained as the difference of level M_1M_3). The L-graph so constructed then tends (with a slight curvature to which Kossel draws particular attention) directly to a characteristic Ne-point. The latter corresponds to the excitation value observed by Franck and Hertz and mentioned on page 338 (16 volts); it is to be interpreted as the fundamental absorption line of the neon spectrum. The point is no longer far from the ground line of Li, the first line of its principal series, $\lambda = 6708$, and it is connected with the point representing this line by a dotted arc of a curve, of which the curvature is partly determined from theoretical considerations. The radical change of the course of the L-graph before and after neon illustrates the contrast between the gradual building up of the L-shell and its completion from Ne onwards. The fact that the construction of the L-shell (or of the L-ring) begins with Li and that therefore the ground line of the Li-spectrum is to be ascribed to the L-series fits in very well with the general picture of the periodic system (cf. Chap. II, § 7, p. 108).

The third and lowest line of our figure represents the graph of the $M\alpha$ -line. This has been measured directly, as we know, only in the case of the heaviest elements (as far down as $Z = 66$); as far as $Z = 40$, it can be found sufficiently accurately from the combination of $L\alpha$ and $L\gamma$. But in the case of the lower elements Kossel finds himself compelled to have recourse to the much more uncertain combination of $K\beta$ and $K\gamma$. Since $K\gamma$ denotes the transition from the N-shell, and $K\beta$ that from the

M-shell, into the K-shell (cf. Fig. 47, which has, indeed, been drawn only for very general conditions but is quite appropriate for our present purpose), we see that actually $K\gamma - K\beta$ represents a transition from the N- to the M-shell, and is therefore equal, or more accurately, approximately equal to the principal line $M\alpha$ of the M-series (Fig. 47 allows us to read this off directly). The points thus obtained on the M-graph, owing to their derivation from the difference of two nearly equal quantities, certainly scatter considerably, but they allow us to recognise without constraint its general course, which tends directly to the argon point, 12 volts (according to Franck and Hertz, see p. 338). The argon point is to be combined with the point representing the principal line of the Na-spectrum, namely the D-line, $\lambda = 5890\text{\AA}$. The principal line of the magnesium spectrum (ground member of the principal series of simple lines) $\lambda = 2853\text{\AA}$ (cf. Table 37) fits in here. The small crosses above the two last-mentioned points denote the corresponding series limits (ionisation potentials). In the M-graph, too, the contrast with the M-rings that are successively being formed at the surface of the atom (for the elements from Na to A) and the completed M-shell that contracts more and more in the interior of the atom becomes more and more marked; the latter shell explains the steady course of the M-graph for higher atomic numbers.

Thus the figure is instructive in various respects.

In the first place, it exhibits the similarity of character in the emission of X-rays and of light rays. Each Röntgen series, as the atomic number decreases, ends unmistakably in certain (ultra-violet or visible) lines of the optical spectra.

Secondly, the figure brings out clearly the periodicity of the arrangement or constitution of the atom. Each of the branches of the graphs to be drawn represents a sphere or a shell in such a way that each alkali marks the beginning of a new shell.

Thirdly, the figure allows us to follow the gradual building up of each shell from each alkali to the next succeeding inert gas. The building up finishes with the inert gas and from this point onwards our graph line travels along a straight line towards higher atomic numbers; between the alkali and the inert gas it follows a law which is clearly different. The inert gas forms, so to speak, the corner-stone in the development of the atomic structure and the turning-point for our spectroscopic graph lines, quite in harmony with our reflections on page 103 about the importance of the configuration of the inert gases.

But in other respects the figure is surprising and paradoxical.

It shows that in the case of Li the first H.S.-line corresponds to the Γ -series, whereas in the case of Na it corresponds to the M-series. Thus lines that are of an exactly similar type in the theory of series and that are represented by the same symbol $1s - 2p$, appear as different types

in the Röntgen scheme: the one line is allocated to the L-series, the other to the M-series.

This indicates that the analogy between the outer region and the inner region of the atom is not complete. We have already, earlier, encountered differences between these regions and we explained them by means of the different characters of the quantum orbits (the outer orbits are virtual, the inner orbits are constitutive and have their full quota of electrons; see p. 190). In the visible region the lines may occur both in emission and in absorption, whereas in the Röntgen region they can occur only in emission. In the visible each series line has its particular excitation limit which is lower than the ionisation limit; in the Röntgen region all lines of the same series have the same excitation limit and this coincides with the work of dissociation ("Abtrennungsarbeit") for the shell in question.

Concerning the allocation of quantum numbers we were able in the visible region (§ 2) to characterise each kind of term by a definite value of the azimuthal quantum numbers, for example, the s-terms were characterised by $n = 1$. It was originally thought that in the Röntgen region, too, it would be sufficient to distinguish each shell by one quantum number, for example, the K-shell by $n = 1$, the L-shell by $n = 2$, and so forth. The facts presented by the fine-structure in the Röntgen region show that this is not so (cf. Chap. VIII, §§ 5 and 6). Kossel's figure also brings this out clearly, for the M-series and the L-series, just like the K-series, degenerate as the atomic number decreases to the principal series of the alkalis, that is, resolve into a transition that undoubtedly has the final state characterised by $n = 1$.

Bohr hints at the solution of this apparent contradiction (cf. p. 109) in his letter to "Nature," mentioned on page 59; according to him, there exists a "quantum number" (we purposely express ourselves in indefinite terms) that increases in the successive shells to a maximum, and then decreases, in the manner formerly asserted of the distribution member of the shells. The extreme atomic shell, whether it be the M-shell as in Na, or the L-shell as in Li, always belongs to the "quantum number" 1, and the ground line of the Röntgen series in question can then in the case of each shell pass over without discontinuity into the principal series of the visible region.

The transition between the inner and the outer region of the atom would be brought out more clearly by drawing Kossel's figure for the terms instead of as in Fig. 89 for the lines. As already frequently emphasised, the former are of greater fundamental importance than the latter. The continuous linking up of the lines would follow as a corollary from that of the terms. But at present we cannot yet sketch such a diagram of terms without too great vagueness; our table of Röntgen terms in Chapter VIII, § 6, merely furnishes us provisionally with as yet incomplete connexions.

§ 5. The Permanency of the Multiplicities. Inner Quantum Numbers

In general, spectral lines have not a simple structure, but occur as *doublets*, *triplets*, etc. (cf. p. 318); or, it is better to say that the *terms* from which the spectral lines are composed, are in general not simple but *two-fold*, *three-fold*, and so forth,

We illustrated this in § 1 for the case of the p -term. The p -term of the alkalis is *two-fold*. Instead of mp we therefore wrote in § 1:

$$mp_i, \quad \text{where } i = 1 \text{ or } 2.$$

The p -term in the arc spectrum of the alkaline earths is *three-fold* (or simple, i.e. one-fold). When it was three-fold we designated it by

$$mp_i, \quad i = 1, 2, \text{ or } 3.$$

Earlier, we purposely avoided taking account of the multiplicity of the d -term (cf. p. 319).

We now assert: *together with the p -term, also the d -term and the b -term are two-fold or three-fold. Only the s -term, as already emphasised on page 318, is always simple (one-fold).* This similarity of subdivision which pervades the p -, d -, and b -term we shall call the *permanency of the multiplicities*. In extending this law to the b -term we are carrying out an extrapolation which has hitherto been proved only for isolated examples, and which, as we shall see below, *could* only be proved in particularly favourable cases.

We next consider the various combinations of the s -, p -, d -, b -terms. Concerning the H.S. and the II N.S., which are combinations of the s - and the p -term, we have nothing essential to add to what has already been said on page 319. On account of the simple structure of the s -term and according to the two-fold or three-fold structure of the p -term, the lines of these series are themselves *two-fold* or *three-fold* respectively. The same is true of combinations of the s - and the d -term, which are inadmissible according to the selection principle, and which can be realised only by external electric fields (cf. p. 333). Since in the II N.S. $\nu = 2p_i - ms$ the multiplicity is in the constant term, the doublet or the triplet lines have in this case *constant* $\Delta\nu$'s. Since, on the other hand, in the H.S. $\nu = 1s - mp$ the multiplicity is in the variable term, the $\Delta\nu$'s here *gradually decrease as we approach the series limit*, as, indeed, the mp term itself decreases to zero (cf. p. 327). At the same time, since the sign of the constant term is the reverse of that of the variable term, the order of the intensities of the doublet and triplet lines in the H.S. is the reverse of that in the II N.S. (cf. Fig. 82).

New phenomena, however, occur in the I N.S. $\nu = 2p_i - md_j$. In the doublet systems, $i = 1, 2$ and $j = 1, 2$, we are led to expect *four lines*, corresponding to all possible combinations of i and j , whereas in the case of the triplet systems, $i = 1, 2, 3$ and $j = 1, 2, 3$, we should indeed expect *nine*. We shall see presently that the numbers 4 and 9 in reality

become reduced owing to the fact that some of the components of the line-configuration which are algebraically possible are inadmissible physically. We call the whole line-configuration a *composite doublet* or *composite triplet* respectively; these names are due to Rydberg.* We consider it advisable to avoid the usual term *complete doublet* or *complete triplet* for the reason that it is just the incompleteness of the line-configuration, that is, the actual dropping out of certain of its possible components, which is characteristic of its structure. The first explanation of this structure forms one of the finest achievements of Rydberg; it was given at a time when the systematic structure of series terms and their multiplicities were still wrapt in obscurity.

Passing on to the quantitative aspect, we adopt the convention in conformity with the usual practice that *the terms are numbered within each multiplicity in the order of their magnitude*; thus we always † have

$$mp_1 < mp_2 < mp_3, \quad nd_1 < nd_2 < nd_3 \dots \dots \dots (1)$$

(In doublet systems the third term of this inequality of course drops out.)

Furthermore, if we represent the terms graphically as energy-levels (*Energieniveaus*), then, according to the inequalities (1), the level $p_1(d_1)$ lies *above* the level $p_2(d_2)$, and, in the case of triplet systems, the latter lies *above* $p_3(d_3)$; for the terms are defined as negative amounts of energy $-\frac{W}{h}$, and so, from $mp_1 < mp_2$ it follows for the corresponding energies that $W_1 > W_2$, and so forth. We may therefore also say: *we number the energy-levels within each multiplicity according to their heights, beginning at the highest level with $i = 1$.*

We next illustrate the structure of a *composite doublet* by considering the example of the heaviest alkali Cs (in accordance with a general rule to be discussed later the separation of the components is greatest in this case, and thus observation is easiest). The first member of the I N.S. is $\nu = 2p_i - 3d_j$ for Cs, and lies in the infra-red near the point

* Ann. d. Phys., 50, 625 (1893), cf., in particular, subsection III. See also long paper on "Recherches sur la constitution des spectres d'émission des éléments chimiques." Swedish Academy, Vol. 23. A German translation is about to appear in the series, "Ostwalds Klassiker."

† The fact that the convention (1) may be made uniformly and consistently for all m 's and that the terms which are ordered together by the same i whilst m varies, namely, mp_i or nd_i actually belong together by their nature may be inferred from the approximate validity of Rydberg's method of representation in terms (p. 316). For from the ordering (1) of the terms there follows a corresponding numbering and ordering of the constants p_i, d_i of the atomic field in Rydberg's formula; and, conversely, the former follows from the latter.

We might also number the terms, instead of according to their *magnitude*, according to the *intensity*, with which they occur in the combination sp_i . For it appears that the term mp_1 is almost always the most intense, mp_2 the next most intense, and mp_3 , when it is present, gives rise to the weakest component of the corresponding line-configuration. In the case of the Bergmann series of Cs this enumeration in order of intensity would, according to K. W. Meissner (cf. below), differ from that in order of size, and is to be preferred to the latter on systematic grounds.

in which the upper indices 12, and 23 indicate the origin of the difference from the terms p_2, p_1 , and p_3, p_2 respectively. On the other hand, the three-fold nature of the d -term gives rise to the wave-number differences

$$\Delta\nu_d^{12} = 3d_2 - 3d_1 = 18 \text{ cms.}^{-1}$$

$$\Delta\nu_d^{23} = 3d_3 - 3d_2 = 12 \text{ cms.}^{-1}$$

On account of the comparative smallness of $\Delta\nu_d$ compared with $\Delta\nu_p$ the scale could not be kept uniform in Fig. 91, but it was necessary in the interests of clearness to exaggerate the $\Delta\nu_d$ differences relatively to the $\Delta\nu_p$ differences.

The figure shows that in the composite triplet, too, there are principal lines, satellites, and missing lines (indicated by being dotted in the figure). The principal lines are $2p_1 - 3d_1, 2p_2 - 3d_2, 2p_3 - 3d_3$, and are thus given by $i = j$. The forbidden lines as before satisfy the inequality (3), namely, $i > j$. The totality of the admissible lines, principal lines, and satellites is again determined by (2). The true differences $\Delta\nu_p$ are measured, not as between principal lines, but as between principal lines and satellites, and partly occur twice; the same applies to the differences $\Delta\nu_d$. The whole line-configuration is composed, in a very characteristic way, of $3 + 2 + 1 = 6$ lines, whereas $1 + 2 = 3$ lines are forbidden.

Precisely the same line-configuration of the doublet or triplet scheme occurs, further, in all lines of the I N.S. and, indeed, in all combinations $np_i - md_j$. In proportion as the numbers n and m become greater, the p -differences or the d -differences become less (cf. p. 319, equ. (4)). It may happen that even in the first member of the I N.S. the d -difference is so small that it cannot be resolved. The I N.S. does not then appear as a sequence of composite but of simple doublet (or triplets), just as in the II N.S. This is so in the case of Li, for example. Hereby the following difference between the doublets of the II N.S. and the I N.S. was shown to exist by the measurements of Kent* (carried out in Tübingen): whereas the doublets of the II N.S. fulfil accurately the law of constant differences of frequency (p. 319) and gives the exact difference $\Delta\nu_p$, the doublets of the I N.S. remain slightly below this value and only approach it in the case of the later members. Kent finds from the first two members of the I N.S.

$$\Delta\nu = 0.306 \text{ and } 0.326 \text{ cm.}^{-1}$$

and, on the other hand, from II N.S. he gets

$$\Delta\nu = 0.34 \text{ cm.}^{-1}.$$

The reason of this is clear from Fig 90. In the I N.S. the doublet difference is measured as the distance from the short-wave principal line to the centre of gravity between the long-wave principal line and its satellite

* Astrophys. Journ., 40, 343 (1914).

(which is not distinct from it). This distance or interval is less than the true doublet interval $\Delta\nu_p$, but approaches it in the higher series members in which the (unresolved) d -difference becomes smaller and smaller.

Generally, we see from this example that the *Law of Constancy of Frequency Differences* (or *Wave-number Differences*) is only a *limiting law* (*Grenzesgesetz*) in the case of the I N.S., that is, one which is the more nearly obeyed the higher the number of the member in the series; and the exact structure of the I N.S. can be described only by the co-operation of the two differences $\Delta\nu_p$ and $\Delta\nu_d$. This law is directly and strictly valid only in the case of the II N.S. This circumstance has not, however, prevented it from being of great practical utility, when applied to the I N.S., for the classification of spectra in all those cases in which the accuracy of observation allowed the p -difference but not the d -difference to be resolved.

The "Permanence of the Multiplicities" exhibits itself in the structure of the composite doublets and triplets in the circumstance that a doublet (or triplet) p -term always combines with a doublet (or triplet) d -term, *but that a doublet p -term never combines with a triplet d -term or vice-versa*. In the case of the hydrogen fine-structures, with which we shall deal in Chapter VIII, § 4, the position is, however, different; here, for example, in the Balmer series there is superposed on the doublet structure of the first term $R/2^2$ a triplet structure that arises from the second term $R/3^2$. This in no wise contradicts the law of permanence of multiplicities at present under consideration since, as we made clear from Fig. 86, the hydrogen fine-structures do not correspond to the structures of the terms not of the hydrogen type, but rather to their various series types.

Does the law of permanence apply only to the p -term and the d -term and not to the b -term? When the author* first formulated this question, no certain data were available which might have given an answer. In the meantime this gap has been filled. Only, indeed, in the case of the heaviest elements and when the resolution is very great, may we expect to find definite signs for the two-foldness or three-foldness of the b -term. In the case of the lighter elements and when the resolution is small the multiplicity of the b -term must practically vanish.

And now Saunders† has recently succeeded in showing that the Bergmann lines of the triplet arc spectrum of Ba, $\nu = 3d_i - mb_j$, are composite triplets consisting each of six lines. Furthermore, K.W. Meissner‡ has measured composite doublets in the B.S. of Cs, which according to the position of their satellites do not quite agree with what is expected,§ but at least show the characteristic number of two principal lines and one satellite and exhibit the relationship between their intervals and the

* Ann. d. Phys., **63**, 228 (1920.)

† Astrophys. Journ., **51**, 23 (1920).

‡ Ann. d. Phys., **65**, 378 (1920).

§ The anomaly that has arisen here vanishes if we number the b -terms not according to size but according to intensity (cf. foot-note 1 on p. 359).

difference $\Delta\nu_d = 3d_2 - 3d_1$. Popow* has revealed a composite Bergmann doublet of unusually great resolution in the doublet spark spectrum of Ba; it has the wave-number differences

$$\begin{aligned}\Delta\nu_d &= 3d_2 - 3d_1 = 801 \text{ cms.}^{-1}, \\ \Delta\nu_s &= 4b_2 - 4b_1 = 225 \text{ cms.}^{-1}.\end{aligned}$$

We shall see in the next section that in this very case, in which the two-foldness of the Bergmann term was first observed, the conditions for observing them are as favourable as can be desired. For, in the spark spectrum, the term difference (here $\Delta\nu_s$) is, in round numbers, four times as great as in the arc spectrum.

Thus the permanence of the multiplicities is, as far as the Bergmann terms, a fact that dominates the whole structure of systems of the doublet and triplet lines. What physical meaning are we to attach to this? What circumstances bring about the subdivision of the energy-levels of the atom and ensure that the number of subdivisions remains constant in the various series? In § 2 we proposed the question: What circumstances produce the separation of the one hydrogen series into the various series or types of series in the case of the elements not of the hydrogen type? We there answered this question thus: These circumstances are due to the *additional electrical field* which is superposed on the simple resultant Coulomb field arising from the nuclear charge and the electronic charges; by taking this into account we succeeded in confirming, besides the number and sequence of the various series, also the general (Ritz) character of the series formulæ. In the present case, everything urges us to enlist the aid of an *intra-atomic magnetic field* such as, in particular, occurs in the intimate relationship in which the problem of term multiplicities stands to the problem of the anomalous Zeeman effect. This magnetic view of the origin of term multiplicities is completely confirmed by observations of Paschen, which are connected with the problem of forbidden lines in the composite doublet and triplet and wherein these lines are called forth by a *magnetic field*.†

Another circumstance seems to indicate that the intra-atomic magnetic field that is responsible for term multiplicities is produced by the circulation of the outer electrons of atoms. For in the case of equal valency the multiplicities are of the same type: they are doublets in the case of uneven, and triplets in the case of odd valency (cf. next section). Now since the valency is given by the number of outer electrons of the atom, the origin of the inner magnetic field also seems to be founded on the number and the motion of the outer atomic electrons. We shall substantiate this further in the appendix to § 7; for the present we shall confine ourselves to a rather qualitative theory discarding special ideas.

* Ann. d. Phys., 45, 172 (1914).

† F. Paschen and E. Back, "*Liniengruppen magnetisch vervollständigt.*" Zeeman Jubilee Issue of the Dutch journal "Physica," 1921, p. 261.

The point from which we launch our attack is given by the forbidden components of the composite line-configuration. These components imply that the azimuthal quantum number n introduced in § 2 does not suffice for all purposes. For all p -levels it is equal to 2, for all d -levels it is equal to 3, and so forth, and it cannot therefore effect a determinate selection between the levels p_i and d_j . So that if we wish to exclude the forbidden lines by a principle of selection, we must, indeed, introduce a new quantum number; we call it the **inner quantum number** and designate it by n_i .

In Fig. 92 we illustrate our procedure for the case of *doublet systems*. The ground level s is lowest (greatest negative energy and highest positive term*). To it there corresponds the azimuthal quantum number $n=1$. For the ground orbit and indeed for all s -terms we also set $n_i=1$.

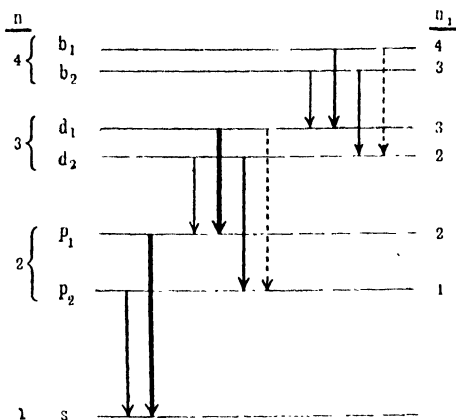

FIG. 92.

The p -levels lie above it (have smaller terms*); beginning from the top, we number them p_1 and p_2 . Their azimuthal quantum number is $n=2$. We assign to them the inner quantum numbers

$$p_1 \dots n_i = 2, \quad p_2 \dots n_i = 1$$

and this is to hold not only for the term $2p$ but for all terms mp , that is, independently of the radial quantum number n' . We draw the d -levels above the p -levels; they are less separated than the latter, and the b -levels still less so. Their inner quantum numbers are, as we know, $n=3$ and $n=4$, respectively. We set down as azimuthal quantum numbers

$$\begin{aligned} d_1 \dots n_i = 3, & & d_2 \dots n_i = 2 \\ b_1 \dots n_i = 4, & & b_2 \dots n_i = 3 \end{aligned}$$

and generally for the azimuthal quantum number n :

$$\dots n_i = n, \quad \dots n_i = n - 1.$$

* Cf. also what was said in foot-note 1, p. 341, about Al, In, Tl.

We next formulate our **Selection Principle of Inner Quantum Numbers**. Whereas the azimuthal quantum number can in general undergo only the transitions

$$n \rightarrow n \mp 1$$

the following transitions, and *only* these, are possible for the inner quantum number :

$$n_i \rightarrow n_i \mp 1, \quad n_i \rightarrow n_i \dots \dots \dots (4)$$

Thus, in this case, $\Delta n_i = 0$ is not forbidden.

This rule of selection is to be supplemented by a rule of intensity: of the three transitions (4) that one is to occur with greatest intensity which takes place in the same direction as the transition to the azimuthal quantum number n ; and the intensity is to increase so much the more the more the type of the transition of n_i differs from that of n . Hereafter we shall thus speak of a "strong," a "less strong" and a "weak transition."

Let us now consider from the point of view of this principle of selection and of this rule of intensity the combinations $(p_i d_j)$ in the I N.S. of the doublet systems, such as are depicted in the middle part of Fig. 92. The azimuthal quantum number hereby falls from the value 3 (d -term) to 2 (p -term). Accordingly we have two "strong" transitions of the inner quantum number $3 \rightarrow 2$ and $2 \rightarrow 1$, which actually correspond to the two principal lines $(p_1 d_1)$ and $(p_2 d_2)$, $i = j$. The transition $2 \rightarrow 2$ of the inner quantum number, which belongs to the satellite $(p_1 d_2)$ is "less strong"; the combination $(p_2 d_1)$, $i > j$, is forbidden because, in it, the inner quantum number would make a jump of two units, from 3 to 1. Exactly the same holds for the combinations $(d_i b_j)$ of the Bergmann lines, cf. the upper right half of the figure. Here, too, the two principal lines correspond to the transitions $n_i \rightarrow n_i - 1$, and the satellite corresponds to the transition $n_i \rightarrow n_i$; the combination $(d_3 b_1)$, $i > j$ is also forbidden because it would denote a transition from 4 \rightarrow 2.

Finally, concerning the combination (sp_i) , in the H.S. or the II N.S., the two transitions $2 \rightarrow 1$ and $1 \rightarrow 1$ are allowable, but are to be expected, according to our principle of selection, to be of varying intensity. In the case of Na we have, for example, for D_1 , $\lambda = 5896$, and D_2 , $\lambda = 5890$ (cf. Fig. 82):

$$\left. \begin{array}{l} D_2, \quad \nu = 1s - 2p_1, \quad (n_i = 2) \rightarrow (n_i = 1) \\ D_1, \quad \nu = 1s - 2p_2, \quad (n_i = 1) \rightarrow (n_i = 1) \end{array} \right\} \dots \dots \dots (5)$$

Actually, according to many exact measurements D_2 is more intense than (indeed, exactly twice as intense as) D_1 . In the higher members $m = 3, 4 \dots$ of the H.S. of the alkalis the difference of intensity of both components, as Füchtbauer* has shown, increase regularly in such a way that here in place of the ratio 2 : 1, we get, say, 3 : 1, 4 : 1 . . .

It is clear that our above remarks fix only the differences Δn_i of the inner quantum numbers and not their absolute values n_i . It is possible

* Ann. d. Phys., 43, 96 (1914), in conjunction with W. Hofmann.

to alter all the n_i -values of the figure by adding the same number throughout, without affecting our conclusions about the possible existence and intensity of the lines. But we shall see that the selection here made concerning the absolute values n_i is also maintained in the phenomena of the Zeeman effect (§ 7).

We now come to the *triplet systems*. The scheme of inner quantum numbers is now to be extended in the manner shown in Fig. 93. In the highest level of each term the inner quantum number n_i again agrees with the azimuthal quantum number n and thence onwards decreases in two steps by 1 each time, that is in the p -levels from 2 to 0, and in the d -levels from 3 to 1, and so forth.

The scheme of the composite *triplets* ($p_i d_i$) in the I.N.S. here also follows naturally and satisfactorily. Principal lines arise from "strong"

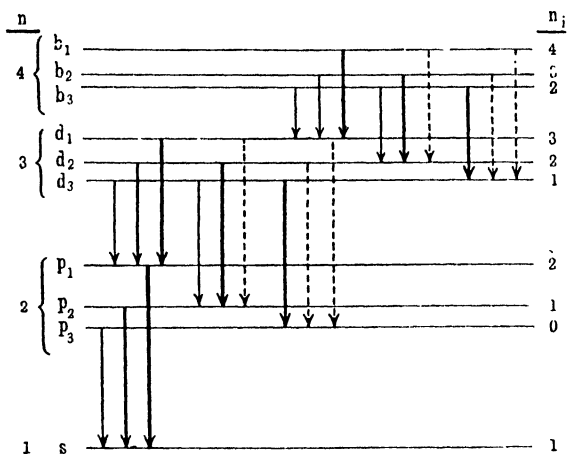

FIG. 93.

transitions, in which n_i decreases by 1, and thus moves in the same sense as the azimuthal quantum number n , which simultaneously decreases from 3 to 2. Primary satellites arise from the "less strong" transitions $\Delta n_i = 0$; the secondary satellite ($p_1 d_3$) arises from the "weak" transition $1 \rightarrow 2$ of the inner quantum number, which occurs in the reverse direction to that of the transition $3 \rightarrow 2$ of the azimuthal quantum number. The forbidden lines, according to their indices given by $i > j$, belong to transitions in which n_i jumps by two or, in the case of ($p_3 d_1$) by three units. It is characteristic that in the investigation of Paschen mentioned on page 363, the line ($p_3 d_1$) was much more difficult to call up than the two other forbidden lines. The ground for this is evidently that when $p_3 d_1$ is produced by magnetic means our principle of selection is infringed to a much greater degree (jump of three units) than in the case of the other two lines (jump of two units).

Exactly as in the I.N.S. so in the B.S. the type of the composite

triplet may be analysed by inner quantum numbers, as indicated briefly in Fig. 93.

In the combinations (sp_i) in the H.S. or the II N.S. no forbidden transitions occur, but the intensities grade themselves in the sequence (sp_1), (sp_2), (sp_3), corresponding to the circumstance that in the first of these combinations we have a "strong," in the second we have a "less strong," and in the third a "weak" transition; actually in the last transition n_i alters in the reverse direction to n , and indeed in the H.S. as well as in the II N.S., whereas in the first transition it alters in the same sense.

Very interesting new material for the question of selection is furthermore given by the combinations of triplet and simple terms, such as are usual in the whole group of divalent elements, the alkaline earths and related elements. We here recall only the resonance line of Hg, $\lambda = 2537$, $\nu = 1S - 2p_2$, and the analogous lines given in Table 37 for Zn, Cd, Mg, . . . Ba. As previously we denote the simple terms throughout by S, P, D, and the triplet terms by s , p_i , d_i . The following scheme gives us the key to these combinations:

Allowed types: $Sp_2, Pd_2, Pd_3, p_1D, p_2D$.
 Forbidden types: Sp_1, Sp_3, Pd_1, p_3D .

For example, the following have been observed (cf. Dunz):

$2P - md_2$ and $2P - md_3$ for $m = 3$ in the case of Zn,
 and for $m = 3, 4, 5$, in the case of Cd and Hg.
 $2p_1 - mD$ and $2p_2 - mD$ for $m = 3$ in the case of Cd,
 for $m = 3, 4, 5, 6$ in that of Hg.

The next step is to assign to the simple terms such quantum numbers as make the exclusion of these lines intelligible in the light of selection. There can be no doubt about the azimuthal quantum numbers: we have to set $n = 1, 2, 3$ for S, P, D. That, in addition, inner quantum numbers are also effective in the simple terms is shown directly by the forbidden combinations. In selecting these we follow Landé's* example. We set $n_i = 0, 1, 2$ for S, P, D. We see at once then that (Pd_1) and (p_3D) are forbidden. As illustrated in Fig. 94, (Pd_1) would be the transition $3 \rightarrow 1$, (p_3D) the transition $2 \rightarrow 0$. The combination (Sp_1) is also forbidden, according to our principle of selection, since it likewise corresponds to the transition $2 \rightarrow 0$. A certain difficulty arises, however, in the exclusion of (Sp_1); to exclude this combination we must follow Landé by asserting definitely that the transition $0 \rightarrow 0$ is not "less strong," as would be the case according to our general rule of intensity, but must *not occur at all*. The fact that, on the other hand, the combination (Sp_2), in the case of Hg the line $\lambda = 2537$, occurs intensely and dominatingly is in complete accordance with our general rule of intensity,

* A. Landé, Physikal. Zeitschr., **22**, 417 (1921).

since we are here concerned with the "strong" transition $1 \rightarrow 0$ which occurs in the same sense as the azimuthal transition. But the conditions of intensity $(p_1D) : (p_2D)$ and $(Pd_2) : (Pd_3)$ are verified by observation to be such as our rule of intensities leads us to expect and as are indicated in Fig. 94. (p_1D) belongs to the "weak" transition $2 \rightarrow 2$, (p_2D) to the "strong" transition $2 \rightarrow 1$; accordingly, (p_2D) is observed throughout to occur more intensely than (p_1D) . On the other hand, (Pd_2) belongs to the "strong" transition $2 \rightarrow 1$, (Pd_3) to the "weak" transition $1 \rightarrow 1$; and actually, (Pd_2) is throughout observed to occur more intensely than (Pd_3) .

A perhaps still more striking confirmation of the fruitfulness of our inner quantum numbers is furnished by certain combinations $(d_i d'_j)$ and

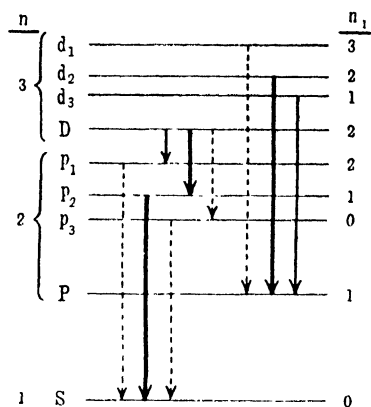

FIG. 94.

$(p_i p'_j)$ that occur between the triplet systems of the alkaline earths. The terms p_i, d_i in these combinations are those that we already know from the composite triplets of the I N.S.; the terms p'_j, d'_j are new terms which combine with the former in spite of the fact the jump in the azimuthal quantum number is not ± 1 but 0. How this is to be viewed in the light of Bohr's Correspondence Principle will be discussed in Note 10 (g).

Types of this sort were first described by Rydberg* in the cases Ca and Sr, and by Popow† in that of Ba, under the heading "skew-sym-

metrical combination groups." At the present time they are being studied by R. Götze ‡ in Tübingen in connexion with their Zeeman types. They are not composed, like the composite triplets, of $3 + 2 + 1$, but in the case of $(d_i d'_j)$ of $2 + 3 + 2$, and in that of $p_i p'_j$ of $2 + 3 + 1$ components. According to Götze their structure may be understood as follows from the scheme of inner quantum numbers.

In Fig. 95 we depict the group $(d_i d'_j)$. The levels $d'_1 d'_2 d'_3$, being initial levels, lie higher than the levels $d_1 d_2 d_3$ that are final levels. As was done earlier, the azimuthal and the inner quantum numbers have been written along the side of the scheme of levels. There are two transitions to d_1 ($n_i = 3$), namely, the one starting from d'_1 , $n_i = 3$, and the other from d'_2 , $n_i = 2$. The transition $d'_3 \rightarrow d_1$ is forbidden, because it would denote a jump of two units in the inner quantum number. All three transitions to d_2 are allowed, but again only two to d_3 . The jump $d'_1 \rightarrow d_3$ is forbidden

* Ann. d. Phys., 52, 119 (1894).

† Ibid., 45, 156 (1914).

‡ The author is indebted to Messrs. Paschen and Götze for kindly communicating to him the result of these investigations.

because the inner quantum number would have to jump by *two* units: all these circumstances agree with observation. We see that the structure of this line configuration differs in a characteristic way from the composite triplets of the I N.S. The index rule $i > j$ which was set up for the latter and which sifted out the forbidden components, loses its validity, whereas *the rule of selection of inner quantum numbers holds undiminished sway.*

But our *rule of intensities* is also shown to be fully trustworthy. As the azimuthal quantum number n is equal to 3 in the initial and the final state, and its jump Δn is therefore equal to 0, those transitions of the inner quantum number n_i , for which $\Delta n_i = 0$, are now to be regarded as occurring in the same sense as n . Here actually, as denoted in Fig. 95, the combinations $(d_1d'_1)$, $(d_2d'_2)$, $(d_3d'_3)$ are the *strongest*. In the middle group $(d_2d'_2)$ the "satellites" lie on *both sides* of the "principal line" $(d_2d'_2)$; in the group $(d_3d'_3)$ we have one satellite on the *short-wave* side, that is fundamentally different from the type of composite triplets in the I N.S., but completely in agreement with our rule of intensities for inner quantum numbers.

In the combination $(p_i p'_i)$ the same "skew-symmetrical type" occurs, but with the following characteristic difference: whereas in the case of $(d_i d'_i)$ the line $(d_3d'_3)$ belonged to the three principal lines, in the case of $(p_i p'_i)$ the line $(p_3p'_3)$ is *missing*.

To account for this we must note that here the inner quantum numbers are not 3, 2, 1 but 2, 1, 0 (cf. Fig. 93), so that the combination $(p_3p'_3)$ signifies the transition $0 \rightarrow 0$. According to our observations of the Hg-combination Sp_3 this transition is to be excluded by a special convention. Thus this special convention is also found to be trustworthy under entirely new conditions. The absence of the line $p_3p'_3$ brings it about that, as we said above, the group $(p_i p'_i)$ consists of $2 + 3 + 1$ lines and not, like the group $(d_i d'_i)$ of $2 + 3 + 2$ lines or, like the composite triplet in the I N.S., of $3 + 2 + 1$ lines.

If we now add that the inner quantum numbers of the triplet and simple lines in the anomalous Zeeman effects (§ 7) prove to be quite as trustworthy as was just emphasised in the case of the doublet systems, we can hardly doubt any longer that the quantum phenomena here involved are real. Nevertheless we must emphasise that all the preceding regularities denote rather a representation of the empirical facts arranged according to a theoretical view-point than a true theory.

The following data about the *size* of the term-multiplicities have a still more empirical nature:—

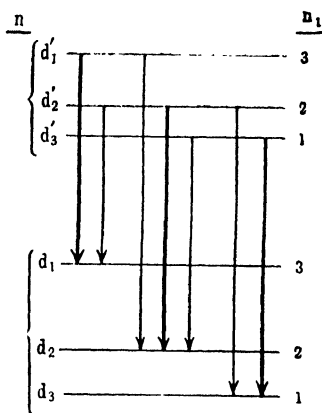

FIG. 95.

(a) **The difference of level of the doublets of the p - and the d -terms.**
 Extending the nomenclature of page a little we set

$$\Delta\nu_{2p} = 2p_2 - 2p_1, \quad \Delta\nu_{3d} = 3d_2 - 3d_1, \quad \Delta\nu_{3p} = 3p_2 - 3p_1$$

and from Dunz's tables we have :

TABLE 39.

	$\Delta\nu_{2p}$	$\Delta\nu_{3d}$	$\Delta\nu_{3p}$	$10\frac{\Delta\nu_{2p}}{Z^2}$	$100\frac{\Delta\nu_{2p}}{Z^3}$
3 Li . . .	0.84	—	—	0.88	1.26
11 Na . . .	17.21	—	5.47	1.42	1.29
19 K . . .	57.90	1.65	20.34	1.61	0.84
37 Rb . . .	237.71	?	77.57	1.74	0.47
55 Cs . . .	554.10	97.90	181.07	1.83	0.38

The first column shows that the p -difference, $\Delta\nu_{2p}$, increases rapidly with the atomic number : whereas this difference can just be distinguished in the case of Li, it is of macroscopic size in the case of Cs. The same is true to a still greater degree of the d -difference, $\Delta\nu_{3d}$, which is not yet distinguishable in the case of Li and Na. For the rest, it is considerably smaller than the p -difference, being not only smaller than $\Delta\nu_{2p}$, but also smaller than $\Delta\nu_{3p}$.

Let us now consider the last columns of the table, in which we have compared the p -difference with the atomic number Z . We see that it increases a little more rapidly than Z^2 but less rapidly than Z^3 . We cannot fail to recognise that it depends in a regular way on the atomic number. This circumstance points directly to the co-operation of the inner

TABLE 40

	$\Delta\nu_{2p}$	$\Delta\nu_{3d}$	$10\frac{\Delta\nu_{2p}}{Z^2}$	$100\frac{\Delta\nu_{2p}}{Z^3}$
13 Al . . .	112.07	1.32	6.6	5.1
43 In . . .	2212.63	23.59	9.2	1.9
81 Tl . . .	7792.45	81.64	11.7	1.5

configuration of the atom in the resolution into terms. Whereas in other cases the nuclear charge is screened by the electronic cloud in the case of the visible spectra (this corresponds to their origin at the surface of the atom), it shines through this cloud, as we remarked on page 101, in the resolution into terms. A comparison showing the analogy with the doublet differences in the Röntgen region which arise at the centre, but which increase essentially with Z^4 , immediately suggests itself (cf. p. 176).

The same remarks may be applied, both as regards the relative magnitudes of the p - and the d -differences, and the dependence on the atomic number, to Table 40 dealing with the earths Al, In, Tl, which are characterised by systems of doublet series.

Here, too, the p -difference increases approximately proportionally to Z^2 and at any rate less rapidly than Z^3 . For the same Z the p -difference is essentially greater than in the case of the alkalis.

(b) **The differences of level of the triplets.** In the triplet arc spectra of the alkaline earths and of the related elements Zn, Cd, Hg we have two differences of level for each term; we designate them as on page 360. These, too, increase in each of the two columns regularly with the atomic number, and indeed, as the following table shows, they again increase more rapidly than Z^2 :—

TABLE 41

	$\Delta\nu_p^{12}$	$\Delta\nu_p^{23}$	$10\frac{\Delta\nu_p^{12}}{Z^2}$	$\Delta\nu_d^{12}$	$\Delta\nu_d^{23}$	$\frac{\Delta\nu_p^{12}}{\Delta\nu_p^{23}}$	$\frac{\Delta\nu_d^{12}}{\Delta\nu_d^{23}}$
12 Mg . . .	40.92	19.89	2.85	—	—	2.06	—
20 Ca . . .	105.99	52.11	2.65	22.13	13.87	2.05	1.6
38 Sr . . .	394.44	187.05	2.74	100.68	59.99	2.10	1.8
56 Ba . . .	878.4	370.3	2.83	381.1	181.5	2.38	2.1
30 Zn . . .	388.91	189.78	4.31	4.55	3.40	2.05	1.34
48 Cd . . .	1171.05	541.86	5.10	18.26	11.72	2.17	1.56
80 Hg . . .	4630.31	1767.19	7.25	34.90	59.94	2.62	0.59

The last two columns that have here been added to the tables of doublets are of interest. They show that the ratio of the two p -differences is, fairly regularly and with only slight fluctuations, nearly constant within each of the two columns of elements, in such a way that

$$2p_2 - 2p_1 \cong 2(2p_3 - 2p_2).$$

This behaviour differs characteristically from that of the hydrogen triplet which we shall consider more closely in Chapter VIII, § 3, equ. (8). In the hydrogen triplet the ratio of the successive triplet intervals is exactly as 1 : 3, whereas in the present triplets that are *not* "hydrogen-like" the ratio is approximately as 2 : 1. Actually the inner cause of the former line configuration (namely, relativistic change of mass) is quite different from that of the latter configuration (inner magnetic field).

The circumstances are similar in the case of the d -differences of the triplets; here, too, the quotient $3d_2 - 3d_1 : 3d_3 - 3d_2$ is fairly constant and greater than 1. Only Hg exhibits an anomalous behaviour, in that the first d -difference is smaller than the second. For this reason we have chosen as our example in Fig. 91 not Hg but Cd.

In the appendix to § 7 we shall return to the question of the magnitude of this ratio (2 : 1 in the case of the p -term, and about 3 : 2 in that of the d -term).

Pronounced systems of triplets occur not only in the second group but also in the elements O, S, Se of the sixth group of the periodic system. The p -differences here exhibit a similar behaviour as in the second group, namely, there is again an approximate proportionality to Z^2 and the ratio of the first to the second triplet difference is approximately constant. The d -differences are not resolved.

TABLE 42

	$\Delta\nu_p^{1,2}$	$\Delta\nu_p^{2,3}$	$100\frac{\Delta\nu_p^{1,2}}{Z^2}$	$\frac{\Delta\nu_p^{1,2}}{\Delta\nu_p^{2,3}}$
8 O	3.38	2.76	5.3	1.23
16 S	17.90	11.26	7.0	1.59
33 Se	103.66	44.82	9.0	2.32

§ 6. Spectroscopic Law of Displacement and Law of Exchange

(a) **Law of Displacement.** In practical spectroscopy we distinguish between spark spectra on the one hand and flame and arc spectra on the other. Speaking generally we may say that spark spectra require strong provocation such as is offered by condensed discharges, whereas flame and arc spectra occur when the excitation is less, namely, thermal or electric.

The line of demarcation between these two types of series has not been sharply drawn by experiment. The spark lines often occur in certain parts of the arc even when the excitation is only ordinary but they then become "enhanced" in the stream of sparks. On the other hand some arc lines are as a rule present in the emission of the spark.

From the point of view of theory, however, we must differentiate by a simple and unambiguous definition between arc and spark spectra. In our treatment of the series scheme of § 2 we assumed that the atom under consideration was, as a whole, *neutral*; the jumping electron (cf. p. 325) is then confronted by an atomic trunk of which the effective charge is $+e$. Following Bohr, we associate this case with the *flame* and *arc spectrums*. On the other hand, according to Bohr, to produce a **spark spectrum** we must have an **ionised atom** and (in the case of simple ionisation) an atomic trunk with an effective charge $+2e$. *We shall here always take spark spectrum as the system of emission of the ionised atom in the sense denoted by this theoretical distinction.* For the present, only cases of simple ionisation come into question, since only such have been observed—in general we shall hold in reserve for the system of the simply ionised atom the name "first spark spectrum," for that of the doubly

ionised atom the name "second spark spectrum," and so forth—in case these terms should prove necessary later.

The simplest examples of spark spectra in this sense are given by the emission of He^+ in the Fowler and Pickering Series (cf. (6a) and (7a) of p. 207). The simplest examples of spark spectra of the second order would be realised, if observable, by the emission of Li^{++} . The general form of representation of terms for a doubly charged atomic trunk is (cf. Note 13, eqn. (18)):

$$(m, k^* \dots) = \frac{4R}{[m + k^* + \kappa^*(m, k^* \dots) + \dots]^2} \quad (1)$$

The occurrence of $4R$ in place of R is an indication of the double charge of the atomic trunk. The coefficients k^* , $\kappa^* \dots$ differ, as a rough calculation shows (cf. Note 13), from the coefficients k , $\kappa \dots$ of eqn. (6) on page 328 in an easily expressible manner.

We next assert that **the spark spectrum of each element is in structure the same as the arc spectra of the element that precedes it in the periodic system**, that is, that it consists of doublet, triplet, or so-called non-series lines, according as the arc spectrum of the preceding element is composed of doublets (like the alkalis), or triplets (like the alkaline earths), or of lines that apparently succeed one another without regularity (like most elements at the right end of the periodic system, in particular the inert gases). Here we have enunciated a **Law of Displacement*** which, like the law of displacement of radioactivity, leads from one element of the periodic system to a neighbouring element.

The meaning of our displacement law as applied to our model of the atom is obvious. Each column of the periodic system is, in general language, characterised by a certain valency, or, in our model, by a certain number of external electrons. On the other hand, we know that the line-structure of the spectra is without exception the same in each column of the series. If now the atom loses one electron by ionisation then it becomes a member of the preceding column in its external behaviour, and thus, as our law of displacement asserts, it will conform in the structure of its lines with the members of the preceding column; numerically it will be best comparable with the element that immediately precedes it in the periodic system.

According to its origin in theory, our law thus uses as its starting point only the most general feature of the atomic model, namely, the gradually increasing number of external atoms in the periodic system. It is completely independent of the particular interpretation of the series terms and their allocation to the quantum numbers. To show on what it is based empirically we shall run through the groups of the periodic system.

* W. Kossel and A. Sommerfeld, Auswahlprinzip und Verschiebungssatz bei den Seriespektren. Verhandl. d. D. Phys. Ges., Jahrg., 21, 1919.

1. **Alkalies and Inert Gases.**—The doublet system of the alkalies is a typical flame spectrum ("sodium-bead") or an arc spectrum; it is thus derived from the neutral and *not* from the ionised atom. The disruption of an electron subjects the atom of the alkali to the greatest conceivable change. It causes the atom to move over into the column of inert gases, that is, from the beginning of one period to the end of the preceding period. Spectrally this must signify the transition from the simple and transparent conditions of the beginning of the period to the complicated conditions at the end of the period in which there is an abundance of lines. We regard the fact that this transition actually occurs as an initial (at present, indeed, only qualitative but impressive) proof of our law of displacement.

Eder and Valenta* found in 1894 that Na and particularly K when subjected to violent sparking emit besides the series spectrum a new spectrum very rich in lines, which lies predominantly in the ultra-violet, and in which it has not yet been found possible to discern series relationships. Later, in 1907, Goldstein† succeeded in selecting the conditions so that the non-series lines of the alkalies appear pure and without the admixture of the arc lines whereas the spark spectra of the alkalies that have been photographed in the usual way exhibit both types of lines simultaneously, and he has very clearly asserted that these (non-series) lines arise from an initial state unconnected with these series, and so he suggested for them the name "*ground spectra.*"

The special conditions which Goldstein chose in his experiments, namely, in which he intentionally forced the greatest possible density of current through matter that was as thinly divided as possible, indicate quite clearly that we are here dealing with emission from atoms which have already been once ionised, that is, that we have that for which we above chose the name "spark spectrum" in the narrower sense.

Goldstein's observations were restricted to the visible region. Eder's pupil Schillinger‡ confirmed the abundance of lines, already remarked by Eder and Valenta, in the ultra-violet which is peculiar to the ground spectra, and which is of importance for our point of view.

The more detailed conditions under which the ground spectra are excited agree well with the ideas that we have formed about the arrangement of the electrons in the atom. The outer electrons of the inert gases, if we judge from their chemical inactivity, are much more tightly bound than the (chemically) particularly active outer electron of the alkalies. The same is to be conjectured of the electronic configuration which the outside of the ionised alkaline atom forms after the outer valency electron has been removed. Thus, in contradistinction to the

* Denkschr. Wien. Akad., **61**, 347 (1894); cf. also Beiträge zur Photochemie, p. 109. Wien, 1904.

† Verhandl. d. D. Phys. Ges., **9**, 321 (1907).

‡ Wiener Sitzungsber., **118** [2a], 605 (1909).

series spectra of the alkalis, the ground spectra must be comparatively difficult to excite, and, in fact, the difference between the possibility of exciting the arc and the spark spectrum is in the case of no other elements so high as in that of the alkalis.

2. **Alkaline Earths and Alkalis.**—In the case of the alkaline earths three series systems are known: simple lines, doublet, and triplet systems.

Of these, simple and triplet systems form plenty of combinations with each other (cf., for example, the conclusion of the preceding paragraph), but not a single one with the doublet system. Further, they are excited by electronic impact with the neutral atom (cf. § 3, p. 347), and, finally, they may be formulated in terms of the simple Rydberg number R . All this proves that simple and triplet terms are associated with the same atomic state, namely, the neutral state. The suggestion of putting our law of displacement to a severer test arose out of a letter by Paschen, in which he remarked that “the doublet systems of the alkaline earths come out relatively much more intensely when excited by sparking than in the arc.” This remark led us to regard the doublet system of the alkaline earths as their spark spectrum, and to bring it into relationship with the doublet system of the alkalis. To support this view it was necessary to study the quantitative expressions for these doublet series, and to try to discover whether, in accordance with equation (1), Rydberg’s number R in it is to be replaced by $4R$. It became manifest that this question had already passed through an interesting stage of historical development.

Ritz* calculated the doublet series of Ca, Sr, and Ba according to his series formula (that is, with R , and not with $4R$), but at that time he had at his disposal only an insufficient number of lines. More detailed measurements and calculations were made by Lorenser.† Following in the footsteps of Saunders, ‡ he showed that Ritz’ formula is inappropriate for representing these series, and he calculated the doublet terms by means of the primarily empirical formula

$$(m, k) = \frac{A}{(m + k)^2} \quad \dots \quad (2)$$

in which we see that R has been replaced by a constant A that may be chosen arbitrarily. Lorenser then found that he obtained a satisfactory expression, especially for the higher series lines, by assuming the following values for A :—

Mg	{	I N.S.	A = 423376·6	Ca	{	I N.S.	A = 423416·0
	{	II N.S.	= 413202·5		{	II N.S.	= 421559·0
Sr	{	I N.S.	A = 410836·0	Ba	{	I N.S.	A = 390431
	{	II N.S.	= 415157·0		{	II N.S.	= 397795

These values are all more or less near $4R = 438948$.

* Physikal. Zeitschr., 9, 521 (1908).

† Dissertation, Tübingen, 1913.

‡ Astrophys. Journal, 35, 352 (1912).

As this agreement is of a purely empirical nature and was found without its author being prejudiced in favour of a particular theory (Bohr's theory was not yet available for Lorensen), it is so much the more convincing.

In the case of Mg the question was again taken up by Fowler* in 1915, and then, indeed, under the direct influence of Bohr's theory. Fowler calculated certain new Mg-lines (e.g. the Bergmann line $\lambda = 4481$), which he had found, as spark lines and compared them with the spark line of He^+ , $\lambda = 4686$, corresponding to the Bergmann series.

It is of interest to mention a chance remark by Fowler to the effect that there is no relationship between the constants of the spark doublet-lines and those of the arc lines of the *same* element. On the contrary, it must be emphasised that the relationship is not to be sought between the spark and the arc lines of the *same* element but between the spark lines of *one* element and the arc lines of its *predecessor*.

Finally, E. Fues,† adopting the view given by the law of displacement, has examined arithmetically the whole data of the doublet spectra of the alkaline earths by inserting instead of the empirical number A as the numerator in the expression of the terms in (2) the value $4R$ itself. The extended expression (1) for the terms then established a perfect link with the observations. At the same time it was shown that there is an interesting relationship between the constants s^* , p^* , d^* , b^* of the atomic fields in the case of these spark spectra and the corresponding constants s , p , d , b of the arc spectra of the alkalis. Both have the same (plus or minus) sign, and (with one exception) the former are always greater than the latter. Details are given in Table 43, in which there are added on the right, next to the atomic field constants under consideration, their ratios.

TABLE 43

	s	p	d	b
Mg ⁺	0.93 } 1.43	0.31 } 2.1	- 0.045 } 2.65	+ 0.0006 } —
Na	0.65 } 1.43	0.15 } 2.1	- 0.017 } 2.65	— } —
Ca ⁺	1.20 } 1.46	0.5 } 1.7	- 0.63 } 2.25	- 0.025 } 2.50
K	0.83 } 1.46	0.29 } 1.7	- 0.28 } 2.25	- 0.01 } 2.50
Sr ⁺	1.32 } 1.64	0.61 } 1.7	- 0.43 } 1.25	- 0.034 } 1.89
Rb	0.91 } 1.64	0.36 } 1.7	- 0.35 } 1.25	- 0.018 } 1.89
Ba ⁺	1.43 } 1.51	0.75 } 1.7	- 0.33 } 0.73	- 0.064 } 2.0
Cs	0.95 } 1.51	0.45 } 1.7	- 0.48 } 0.73	- 0.032 } 2.0

In Note 13, eqn. (17), it is shown that if we adopt a certain convention about the supplementary field due to the electronic configuration a value for the atomic field constants k^* (charge $2e$ of the "trunk" of the

* Phil. Trans., 214 (A), 1914; cf. also Proc. Roy. Soc., 1915; Bakerian Lecture and Nature, 1915.

† E. Fues, Dissertation, Munich; Ann. d. Phys., 63, 1 (1920).

atom) follows which is twice as great as that of the constant k of the associated arc spectrum (the charge e of the atomic trunk is the same, the structure otherwise not differing). From this table we actually see that the ratios in question are almost throughout > 1 , and that in part they approach the value 2.

We have yet to make a remark about the constants s and s^* . Whereas Fues defines them, in the usual way, as the deviation of the numerator of the term from the value $n + \frac{1}{2}$, in the above table they are taken as the deviation from n , in agreement with our notation, which uses integral numbers (thus our s and s^* are greater by 0.5 than the s , s^* of Fues). From the fact that with his definition of s , s^* the ratio 2 is more closely approached than when the integral notation is adopted, Fues concludes that he has found a physical justification for using the notation involving halves. The present author is of the opinion that this inference is no longer tenable in view of the fairly regular course followed by the ratio numbers, for example, in the first two horizontal rows of the table; this regular course would be destroyed by the opposing definition of the constants s , s^* . We are thus inclined to see in this table rather a reason against the usual definition (involving halves) of the s -term.

Even without a close knowledge of the representation in terms we may say the following: If the term $(m\eta_i)$ is of the spark type (1), then, on account of the numerator $4R$, the doublet-difference $\Delta\nu_p = m\eta_2 - m\eta_1$ would be four times as great as the doublet-difference of a neighbouring element of the arc type provided that the constants η_i of the atomic field are assumed to be the same for the two doublets under comparison. The actual difference of the atomic fields will then, further, bring about a deviation from the magnification number 4, be it in the positive or in the negative direction. We have accordingly to expect that every doublet or triplet difference during the transition from arc to spark conditions becomes magnified to an extent that is essentially determined by the ratio 4 of the numerator of the term although it may, of course, deviate more or less from this value owing to the accompanying action of the factors due to the atomic field in the numerators of the term.

Numerical details are given in Table 44; here we are dealing everywhere with the doublet-difference $2\eta_2 - 2\eta_1$. The Ra-doublet* is added to the analogous spark doublets of the alkaline earths, although the preceding alkali (eka-casium), which is necessary for the comparison, is still unknown. In the last two rows of the table the elements Zn and Cd which are, in an extended sense, analogous to the alkaline earths, have been included, as also their predecessors Cu and Ag.

* The Ra-doublet is of special interest because Runge and Precht, in the *Physikal. Zeitschr.*, 4, 285 (1903), have endeavoured to extrapolate the atomic value of Ra from it. For the dependence of the term-differences on the atomic number, which we studied in the preceding section used to be regarded as a dependence on the atomic weight.

TABLE 44.

Mg 92	Na 17·21	Mg : Na = 5·3
Ca 223*	K 57·90	Ca : K = 3·9
Sr 800	Rb 237·71	Sr : Rb = 3·4
Ba 1691	Cs 544·10	Ba : Cs = 3·1
Ra 4858	— —	— —
Zn 872	Cu 248·1	Zn : Cu = 3·5
Cd 2484	Ag 920·6	Cd : Ag = 2·7

Thus the ratio of the doublet-differences compared lies in the case of most elements between 3 and 4, and hence reflects directly the characteristic feature of the spark spectrum, namely, the increase of the effective charge of the atomic residue from e to $2e$ and the increase of Rydberg's number from R to $4R$. Besides this, our table shows that the deviation of our ratio-number from 4 is systematically related to the atomic weight, or, as we may just as well say, to the number of electrons in the atom. In surmising that this deviation is due to the influence of the atomic fields, and that this influence must increase with the number of electrons, the dependence here established becomes readily intelligible.

The fruits of our discussion may be summarised without involving uncertainty as follows: *The doublet systems of the alkaline earths are spark spectra. Their character as doublet systems is accounted for by the doublet character of the arc spectra of the alkalis. Simple numerical relations hold between the spark spectrum of an alkaline earth and the arc spectrum of the directly preceding alkali.*

3. Earths and Alkaline Earths.—Whereas the arc spectra of the alkaline earths are triplet systems (or simple lines), the spectra of the earths are usually doublet systems (cf. p. 370). But, according to our law of displacement, the *spark spectra* of the earths are to have the same character as the *arc spectra* of the alkaline earths, that is, are also to be composed of triplet systems. We have thus to look for triplets in the earths and to ask whether they are to be regarded as spark lines.

Actually, some instances may be found. Firstly, the ultra-violet spark spectrum of aluminium was investigated by Lyman.* (It is clear that, on account of the magnitude of $4R$, the spark spectra will in general have to be sought in the extreme ultra-violet.) Now, according to Popow,† it may be shown that among the lines measured by Lyman, there are several triplets. Further examples are furnished by the spectra of scandium and yttrium, in which, likewise, individual lines arrange themselves into triplets.‡ Owing to the mode of excitation of these lines it is not so immediately evident as in the case of the previously mentioned Al-lines, that they are to be regarded as spark lines (in the photographs by Exner and Hascheck, or Kayser). But if we form the frequency-differences for these lines and compare them with the corresponding

* Astrophys. Journ., **35**, 341 (1912).† Ann. d. Phys., **45**, 166 (1914).

‡ Further details are given in the essay by Kossel and Sommerfeld which we quoted above.

frequency-differences of the arc-lines of the elements calcium and strontium that just precede them in the periodic system, we again get ratios that lie in the vicinity of the number 4 and thus substantiate our belief in the spark character of these lines.

We may, at any rate, certainly expect to find in the series of earths still further examples of triplets, and shall be able to show that they are probably spark triplets. It seems justifiable even now to draw the general conclusion: *The spark spectra of the earths are triplet systems of the same character as the arc spectra of the alkaline earths. There is a regular connexion between each triplet of an earth and that of the preceding alkaline earth.*

4. We drew attention earlier to the possibility of ionising the atom several times (multiple ionisation) and to the existence of spark spectra of higher orders. In the case of two-fold ionisation the resulting *spark spectrum of the second order* would be similar in structure to the arc spectrum of the element that precedes it by two steps in the periodic system (and, on account of the "law of exchange" (*Wechselsatz*) below, at the same time to its own arc spectrum). Hereby Rydberg's number R would have to be replaced, not by $4R$ but by $9R$ (as conjectured in the case of Li^{++} , cf. p. 225). In the *spark spectrum of the third order* we should expect $16R$ in place of R .

In literature no statement is yet to be found about such spark spectra of higher orders. But they, too, cannot fail to come to light now that the attention of spectroscopists has been directed to the question, particularly as the structure of their lines is predicted by the law of displacement, and the sequence of the lines can be determined in general from the magnification of the Rydberg constants; they must be found situated in the ultra-violet and with extended intervals between the lines. In the visible region we may expect of them only the series with higher quantum numbers, namely, Bergmann series and "ultra-Bergmann series" (cf. p. 315).

A general method of distinguishing arc spectra from spark spectra, the difference between which is connected with their Rydberg numbers, is clearly given by determining the excitation potentials, whereby, generally speaking, the spark spectrum demands a considerably higher excitation than the arc spectrum. In connexion with this, compare what was said about Mg^+ in § 3, p. 349, and about He^+ , $\lambda = 4686$, on p. 344.

The difference between arc and spark lines is brought out particularly strikingly and elegantly in the method of the "excitation function" developed by R. Seeliger.* Corresponding with the potential drop in the Geissler tube from the cathode onwards, the spark lines come out

* Ann. d. Phys., **59**, 613 (1919), and particularly Ann. d. Phys., **65**, 423 (1921) (in collaboration with D. Thaeer). The method is not, like that of Franck, quantitative but qualitative. It does not determine the minimum potential at which a line is excited but the optimum, at which it is made to occur with greatest intensity.

considerably shorter in the spectrographic pictures than the arc lines. The assertions of the law of displacement have been confirmed by this method for several lines of Na, Mg, and Hg.

M. N. Saha * has drawn unusually convincing conclusions for solar physics from the differentiation between spark and arc spectra. Of the 92 terrestrial elements only 36 are represented by lines in the solar spectrum. For example, Rb and Cs are not represented at all; K is weakly, but Na strongly represented. Are Rb and Cs, then, not actually present in the sun? Saha's answer is that they are indeed present but only in the ionised state. Consequently the characteristic arc lines of Rb and Cs do not appear, as we should ordinarily expect, but their ground spectra do appear, but, being situated in the main in the ultra-violet, they escape the ordinary methods of observation. The fact that it is just the elements Rb and Cs that are completely ionised in the sun is explained by their low ionisation potential (cf. Table 36). In the case of K the ionisation potential is somewhat, in that of Na considerably, greater; hence also the arc lines of these elements appear in the sun. Furthermore, a characteristic feature is that the doublet spark spectra of Ca, Sr, Ba appear strongly marked in Fraunhofer's spectrum, e.g. the two lines $1s - 2p$ of the H.S. doublet of Ca^+ appear as the Fraunhofer H and K lines. This reasoning receives support from the conditions in the chromosphere, in which on account of the decreasing pressure in the upper layers the ionisation progresses regularly and even the D-lines of Na, for example, vanish.

There is no doubt that in the future, too, the law of displacement will prove to be a trustworthy guide and a regulative principle in the intricate labyrinth of spectroscopic observations.

(b) **The Cross Law or Law of Exchange.** Hitherto we have spoken only of the first three columns of the periodic system, because the series relationships that are known are almost exclusively in these alone. In the following columns only isolated series occur, namely, in column VI in the case of O, S, and Se there is a triplet system for each and, besides, in the case of O a very narrow unresolved doublet system (*Runge and Paschen*); in column VII a triplet system is known in the case of Mn (*Kayser and Runge*). All of these series consist of arc lines, since, as is shown by their expression as series, they are to be written with a single R, and thus belong to the neutral and not to the ionised atom. From the column of inert gases there is still to be added the well-known series of orthohelium and parhelium, doublet lines and simple lines, and the complicated series system into which Paschen † succeeded in resolving the spectrum of neon.

If we now survey the distribution of doublet and triplet series over

* *Zeitschr. f. Phys.*, **6**, 40 (1921); in greater detail in *Phil. Mag.*, **40**, 472 (1920) and **41**, 809 (1921); *Proc. Roy. Soc.*, **99**, 135 (1921).

† *Ann. d. Phys.*, **60**, 405 (1919); Appendix, *ibid.*, **63**, 201 (1920).

the whole periodic system, we cannot escape the impression that there is a regular *reciprocal or cross connexion* between them.

Quite early, Rydberg* had set up the rule that the elements with odd valency lead to doublet systems, and those with even valency to triplet systems. This rule seemed to collapse after doublet systems had been proved to exist in the whole column of the alkaline earths. In recognising that these systems were spark spectra, the contradiction was eliminated and the relationship of the line character to the number of external electrons (valency number in the respective ionisation state) became restored. There thus belong together: *even* ("paired") *electronic numbers and triplets, odd electronic numbers and doublets*. Here and in the sequel we tacitly take "triplets" to include the systems of simple lines that always occur conjointly with them.

Extrapolating the cross relationship which exists between doublet and triplet systems in the first groups we get Table 45 given below.

As we see, our rule passes over the Groups IV and V which have not yet been explored by theory as regards series on to firm ground in Group VI, where the triplet series of O, S and Se arrange themselves in accordance with our expectations.

In Group VII our table again points, in the row marked "sparks," presumably to triplet structure, not only on the basis of our law of displacement which links up the spark spectra of Group VII with the triplet arc spectra of Group VI, but also on the basis of a remark by Paschen which he kindly communicated to the author in a letter, and in which he states that he has found triplet series in the spectrum of Cl and has proved that they are spark spectra (since they have the numerator 4R).

TABLE 45

	VIII or O	I	II	III	IV	V	VI	VII
Arc	No series	Doublet	Triplet	Doublet	—	—	Triplet	?
Spark	?	No series	Doublet	Triplet	—	—	—	Triplet?

We have next to dispose of the apparent contradictions to our cross law. The first is the above-mentioned *doublet spectrum of oxygen*. As a demonstrable arc spectrum it contradicts our cross law just as much as the triplet spectrum of oxygen is in conformity with it. Now there is the following difference between the triplet and the doublet spectrum of O. Whereas under the influence of a strong magnetic field the triplet spectrum exhibits the Paschen-Back effect (cf. the next section), this is not so in the case of the doublet spectrum. The doublet spectrum preserves its double-line character even in such magnetic fields as should easily transform it and, at any rate, behaves quite otherwise than a

* Cf. Kayser, *Handbuch der Spektroskopie*, Bd. II, p. 590, Nr. 464.

typical alkali doublet under corresponding circumstances (again according to a letter received from Paschen). Thus we must discriminate between *proper* or true *doublets* (alkalies, earths, alkaline earths in spark spectra) and *improper doublets*, whereby the Zeeman effect is to be enlisted as the criterion. The doublet series of O are to be designated as improper doublets and are presumably to be regarded as two *simple lines* that lie close together without being intrinsically related, and then they fit in excellently with our cross law; indeed, they supplement the triplet series of O in the same way as the simple lines of the alkaline earths supplement their own triplet series.

The circumstances are similar in the case of the *doublet series of orthohelium*. These, too, are improper doublets, since they exhibit no Paschen-Back effect but rather preserve their individual structure even in the presence of very strong magnetic fields, as is evident from unpublished photographs taken by Back. Since we have to ascribe even valency, zero, to helium, our cross law would here enable us to predict triplet and simple lines. The simple lines of parahelium obey it and the improper doublets of orthohelium which we again wish to regard as pairs of simple lines, do not contradict it.

In our table we have in general stated that the spectra of Group VIII (inert gases and triads) have "no series" (are *serienlos*). In actual fact they seem to be characterised by inextricable confusion (as testified, for example, by the Fe-spectrum). In the case of the inert gases, for example argon, only isolated "sequences," that is, groups of lines with constant differences of frequency may be distinguished. It is scarcely to be doubted that we have to regard these groups as the first signs of series relationships which only for the present appear to lie in confusion. In his treatment of the arc spectrum of neon (see above) Paschen has taught us how, starting from such sequences, we may finally unravel all the spectral regularities. A system of about 900 lines scattered more or less densely over the whole visible region and accumulating in the red is represented by Paschen as a combination of four *s*-, ten *p*-, and twelve *d*-terms, which in part follow a new kind of series laws. This offers abundant material for speculative work in the theory of series.

What is the position here with regard to the permanence of multiplicities? Are there actually more *d*-terms than *p*-terms or may, perhaps, two of the *d*-terms be regarded as improper multiplicities in such a way that the number of proper *p*- and *d*-terms again becomes equal (for example, both equal to 10)? It is, of course, to be noted that the classification of the terms as *s*, *p*, *d* may itself be open to doubt. For example, Paschen had originally claimed some of the *d*-terms as *s*-terms, until K. W. Meissner* recognised them as *d*-terms from their behaviour in the Stark effect.

* *Mittellungen d. Physik. Ges. Zürich*, 1919, Nr. 19, p. 64; Meissner makes use of the observations of Nyquist, *Phys. Rev.*, **10**, 237 (1917).

What selective conditions govern the combination of these various terms? What "composite" line-configurations occur here? Is it possible to distribute inner quantum numbers among the terms in such a way that the observed combinations can be read off from a general scheme? In this connexion Grotrian* and Landé† have already made noteworthy suggestions and have recognised regularities. Can the Ne-spectrum be brought into quantitative relationship with the Na-ground spectrum as is to be required according to our law of displacement? And, above all, does the Ne-spectrum subject itself to the cross law? If we extend this law literally, then in the case of Ne as in that of other elements of even valency we should expect only simple and triplet terms. Now Paschen pointed out early in his first work on neon that among the Zeeman effects of the neon lines as observed by Lohmann‡ there are characteristic types that are known from the Hg-triplets, and Landé summarises Paschen's analysis as signifying that the whole neon spectrum consists of combinations of series of two simple terms, two triplet terms, and a simple term with a triplet term. According to this, then, the cross law would also be brilliantly confirmed in the case of this most complicated of all hitherto ordered spectra. For the rest, it must be emphasised that the Ne-spectrum is far from having been sufficiently investigated magneto-optically, and that, therefore, final conclusions must for the present be postponed.

Finally, we have yet to deal briefly with the triplet series of Mn. They have been declared to be arc lines whereas our table provides for the triplet series in Group VII only as spark lines. The contradiction is overcome by a conjecture of R. Ladenburg § based on chemical facts, according to which the number of outer electrons in the case of Mn and its neighbouring elements would be 2. We here find ourselves at a point of the periodic system, directly before the Fe triad, in the middle of the first great period, where the number of outer electrons no longer increases regularly as at the beginnings of the periods, but rather remain stationary whilst at the same time the whole arrangement of the electrons becomes remodelled (cf. p. 108). It thus becomes intelligible that in the case of these elements the cross relationship between doublet- and triplet-systems drops out and that particularly in the case of Mn the occurrence of the electrons in pairs as suggested by chemical facts produces triplet series as a consequence.

Thus even in the case of Mn there does not seem to be a real contradiction to our cross law, so long as we follow the above procedure and do not refer the exchange (crossing over) of the line-structure to the columns of the periodic system (the *maximum valencies*) but rather to the number

* Physikal. Zeitschr., **21**, 639 (1920).

† *Ibid.*, **22**, 417 (1921).

‡ Dissertation, Halle, 1907. Continued by Takamine and Yamada, Proc. Tokio Math. Phys. Soc., **7**, 277 (1913).

§ Naturwissenschaften, 1920, Heft 1.

of outer electrons actually effective in the emission of lines (*the actual or effective valency*).

The reader will inquire how the relationship between the number of outer electrons and the line-structure, which doubtless exists, is to be explained in terms of the models. In the appendix to the following section we shall give an answer to this question albeit only a provisional one.

§ 7. The Anomalous Zeeman Effect.

In Chapter V, § 6, we developed the quantum theory of the *normal Zeeman effect*. Apart from the case of hydrogen, with the model of which our description linked up, this normal effect occurs only in the case of lines of very simple structure (cf. p. 384) that is, in the case of such lines as are composed of *two simple terms*.* The normal Lorentz resolution amounts to

$$\Delta\nu = \frac{e}{m} \frac{H}{4\pi c} \quad (1)$$

In the transverse effect (observation perpendicular to the magnetic lines of force) it gives the measure of the distance of the middle component polarised in a parallel direction and each of the two outer components polarised in a perpendicular direction.

In the case of multiple lines, on the other hand, *anomalous Zeeman effects* occur. Even when this Zeeman phenomenon was first discovered (in 1896) anomalous resolutions intruded themselves. What Zeeman first observed was a *broadening* of the D-lines which showed itself in the spectroscope, associated with a characteristic *polarisation* of the light at the broadened edges. Now, the two D-lines by no means split up into a normal triplet, but rather the one (D_1) gives rise to a quartet of lines, and the other (D_2) to a sextet of lines polarised partly in a parallel direction and partly in a perpendicular direction (cf. Fig. 96). The fact that Zeeman actually succeeded at all in proving the polarisation of the outer edges of the broadening in this complicated configuration of lines is only due to the circumstance that here as in the normal triplet the perpendicularly polarised components are arranged on the outside and those polarised in the parallel direction lie more towards the middle of the picture of resolution. Whereas initially the departures from the theory of the normal Zeeman effect appeared discouraging from the point of view of quantitative research, now it is just the laws which underlie these departures that claim the greatest interest. As we shall see in the appendix to this section we have to recognise that we have at our disposal in these phenomena, which are just as much ordered as they are manifold, one of the most effective means of laying bare the structure of the atom. For

* In a certain sense this statement is tautologous. For we should only allow such lines to stand as simple lines, and such terms as simple terms, as behave in a normal manner in the Zeeman effect.

the present we shall, indeed, as in the preceding section, not proceed along the lines of the model. Nevertheless we shall succeed in giving a theoretical account of the empirical data, which will borrow its form from the quantum theory of atomic models and of which the claim to physical truth is based on the fact that nowhere does it use undetermined parameters but only whole numbers.

There are two rules that govern the realm of the anomalous Zeeman effects, namely Preston's* rule and Runge's † rule.

Preston's rule states that related lines, that is, lines which are composed of *similar terms*, give rise to the same Zeeman effects. Hereby those terms are defined as similar which have the *same multiplicity* and the *same azimuthal quantum number* (i.e. bear the same symbol *s*, *p*, *d*, . . .). The Zeeman type is on the other hand independent of the radial quantum number (number of the member in the series) and of the chemical nature of the element.

On the other hand Runge's rule states that the line-resolutions that occur in the anomalous Zeeman effects are, when measured in wave-numbers (and not in wave-lengths) rational multiples of the normal

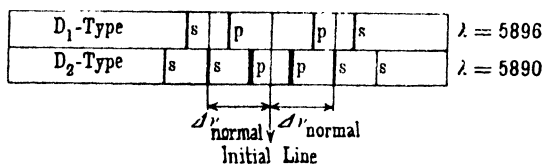

FIG. 96.

Lorentz resolution (1). Let us consider the following two resolution pictures from the point of view of these two rules.

Fig. 96 represents the type of D-lines. Both D-lines have been drawn in spite of their somewhat different wave-lengths, one above the other. In the upper row we have the quartet, in the lower the sextet which we have already mentioned on p. 384. Here *p* denotes "polarised in a parallel direction," and *s* denotes "polarised in a perpendicular direction"; the nomenclature refers to the transverse effect and to the direction of vibration of the electric force at the point of observation relatively to the lines of force of the magnetic field (cf. p. 294). The density of the lines in this as well as in the succeeding figures indicates the approximate intensity of the components. The distances of the components of resolution from the original line are all multiples of $\frac{1}{3}$ of the normal Lorentz resolution: the "Runge denominator" is equal to 3.

The same type of resolution now occurs, besides in the D-lines, also in all members of the H.S. of Na, as well as in the II N.S. which, as we

* Cf. Kayser's Handbuch, 2, 619.

† Physikal. Zeitschr., 8, 292 (1907); the rule was set up on the basis of the particularly abundant Zeeman types of Neon.

know, is built up of the same terms, the s - and the p -term.[†] The same type again occurs in the H.S. and the II N.S. of the remaining alkalis and in the elements Cu, Ag as far as the latter have doublet terms. But the same type also characterises the doublet terms of similar composition in the case of the earths Al, In, Tl, and not only these but also the spark spectra of the alkaline earths and of the elements Zn, Cd, Hg. Preston's rule here links up with our cross law (p. 380). According to Preston's rule the same line-multiplicity (when the combination of terms is the same) entails the same Zeeman type. According to the cross law, on the other hand, the circumstance whether the number of outer electrons is even or odd conditions the equality of line-multiplicity (doublet systems are conditioned by an odd, triplet systems by an even number). Consequently in the groups of the periodic system the Zeeman type must also occur alternately in the arc spectra and must be the same as in the spark spectra of the intervening group. (*Cross Law of the Zeeman Types.*)

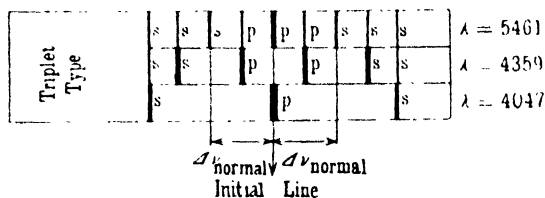

FIG. 97.

Fig. 97 represents as the second most important case the resolution picture of the II N.S. of triplet systems as first observed for Hg by Runge and Paschen.[†] The wave-lengths on the right are the Hg-lines $2p_1 - 1s$, $2p_2 - 1s$, $2p_3 - 1s$. In each case the distances of the components from the original lines are half-multiples of the normal resolution $\Delta\nu$, here Runge's denominator is equal to 2.

But the same resolution picture does not only occur in the triplet lines of Hg given in the figure but also in all similarly constructed combinations of Hg, Cd, Zn, and of the alkaline earths; also in the spark spectra of the earths, as well as in certain lines of Neon, which, on account of the even number of its outer electrons belongs to the alkaline earths, according to our cross law.

Conditions are much more complicated in the I N.S. in the case of the composite doublets and triplets, that is, in the combinations (pd). Fig. 98 represents the resolution picture corresponding to the doublet systems. Here, too, the inner components are polarised in a parallel direction, and the outer ones in a perpendicular direction, as is indicated by the brackets p , s at the lower edge of the figure. Only such p -components as intrude

[†] The use of the symbols s and p for the polarisations as well as for the terms here is unfortunate but can be avoided only with difficulty.

[†] Berliner Akademie, Feb. 1902.

into the region otherwise occupied by *s*-components have been indicated by the letter *p* as such. In the case of all three lines, of which the composite doublet consists, the distances of the components (measured from the position of the original line) are multiples of $\frac{1}{15}$ of the normal resolution. *Runge's denominator amounts to 15.* The "**Runge numerator**" (as we

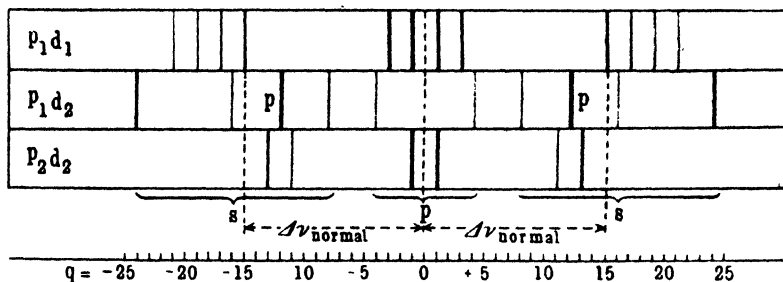

FIG. 98.—I. Subsidiary Series of the Doublets.

shall call the multiple number in question for each component) may be read off from the scale under the figure. It has been designated by *q* and assumes in the complete picture of the three lines the values $\pm (1, 3, 4, 8, 11, 12, 13, 15, 16, 17, 19, 21, 24)$.

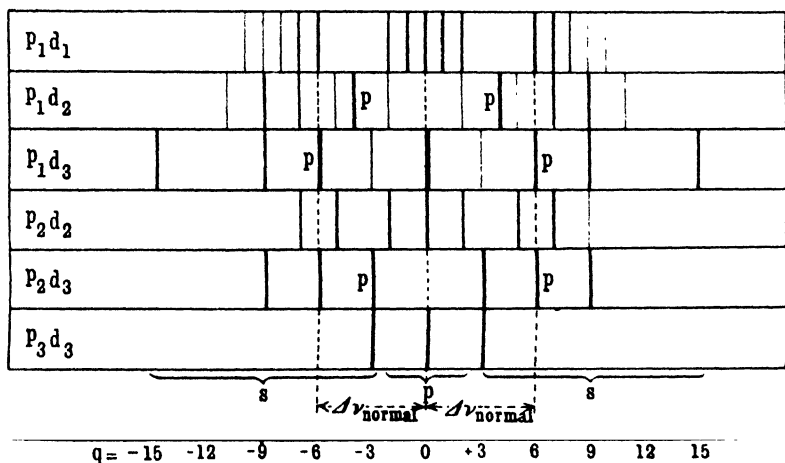

FIG. 99.—I. Subsidiary Series of the Triplets.

The same resolution picture is found present in the case of all composite doublets (*p, d*) in all members of the I N.S. and in all elements with doublet systems. It was first ascertained to this degree of completeness by E. Back.*

Fig. 99 represents the resolution picture for the six lines of the composite triplets (*p, d*). Concerning the arrangement of the picture the

* Short note in the "Naturwissenschaften," 1921, Heft 12.

same is to be said as for the preceding figure. The letter p ("parallel") has been written beside only those components that overlap beyond the middle part of the figure occupied by p -components. *The Range denominator is here 6.* The Runge numerator denoted by q varies from 1 to 15.

A part of the resolution pictures represented in Fig. 99 has already been ascertained by Miller, Moore, and Runge-Paschen. The complete scheme, however, in this case, too, is due to Back.* It holds for the triplet combinations (p, d) of all elements.

We might now inquire into the Zeeman types (d_i, b_j) of the Bergmann series, which have hitherto remained unknown, or into the combination $(p_i S)$, $(p_i D)$, $(P d_j)$ between simple and triplet lines, which have in many cases been observed, or into the combinations $(d_i d'_j)$, $(p_i p'_j)$ (cf. p. 368). We prefer, however, to add some remarks about this in relationship with the theory, which teaches us how to get a survey of all possible resolutions. Here it only remains to emphasise that the preceding figures are far from exhausting the abundance of anomalous Zeeman effects.

The Zeeman effect has long been used as the most powerful means of classification in getting a survey of the series relationships of spectral lines. Only such lines can be regarded as properly arranged or ordered which exhibit the Zeeman effects to which they are entitled by Preston's Rule, and which are the same for similar elements. We recall, for example, those multiplicities which (in the case of He and O) we called "improper." The contradiction to Preston's rule here indicates that the doublet view is a necessary one. Even nowadays there are sufficient spectra that elude being ordered into series, but they, too, will finally have to disclose their inner structure when subjected to the criterion of the similarity of the Zeeman effects.

A large group of apparent contradictions to the Preston rule has been cleared up by the important discovery of the **Paschen-Back effect**.† We begin by distinguishing between "weak" and "strong" magnetic fields. A field is to be regarded as weak when the displacements $\Delta\nu$ produced by it are small compared with the original distances $\Delta\nu_0$ between the lines when no field is present; it is to be regarded as strong when these displacements are large compared with $\Delta\nu_0$. The terms "strong" and "weak" have thus a sense relative to the magnitude of the line-multiplicity which happens to be under consideration at the moment.

In the case of weak fields the Zeeman type of each line of a line-configuration can develop itself undisturbed by the Zeeman type of the neighbouring line. But as the field increases, the resolution pictures of the neighbouring lines tend finally to overlap and interpenetrate. But before this stage arrives the Zeeman types exert a mutual influence on

* Dissertation, Tübingen, 1921.

† Ann. d. Phys., **39**, 897 (1912), and **40**, 960 (1913).

each other. The resolution pictures shown in our figures experience disturbances and distortions. In the case of strong fields an asymptotic condition finally sets in, as if the original multiplicities were not present at all. Under the influence of a field that is strong in the above sense every line-configuration behaves like a simple line, as we may easily understand, and exhibits the normal Zeeman effect. That is what Paschen and Back proved in the case of a number of narrow doublets and triplets. Our definition of strong fields entails that for a simple line even the weakest magnetic field is to be regarded as "strong." For the D-lines of Na (initial separation is 6 Å) a field of 180,000 gauss, which cannot be produced in reality, would just produce the complete Paschen-Back effect. The first stages, however, of the transformation and mutual influence between D_1 and D_2 may be shown by a field of 30,000 gauss.* In the magneto-optic investigation of the corresponding lithium line $\lambda = 6708$ whose components on the other hand, are originally only 0.13 Å apart, we very soon arrive at the conditions of the Paschen-Back effect; its transformation may thus be observed as far as the final stage of the normal triplet.† Compared with the remaining alkalis, lithium used to appear an exception to Preston's rule; through the discovery of Paschen and Back this and many other exceptions have been cleared up.

Besides the "total" Paschen-Back effect we have also to consider a "partial" one. By this we mean, for example, the case that in the combination (pd) the magnetic field is strong enough relative to the small d -difference but weak relative to the greater $\Delta\nu$ of the p -difference. In this case we should no longer write the line-configuration as (pd) but as ($p;d$), and should then be able to treat the d -term as a simple term. (Further details are given at the end of this section.) The Zeeman type is then neither the normal one as in the case of two simple terms, nor the one, as in the case of two multiple terms represented in Figs. 98 and 99; but it may be predicted from the general theory that is to be developed, and is, indeed, found to be in agreement with experiment.

Of course, the Paschen-Back effect links together only such lines as belong together in a series as multiplicities. Two lines of two different series, however near together they may be, in no wise affect each other magneto-optically in this case, the two resolution pictures interpenetrate without influencing each other. This, too, is the reason why we have not to expect a Paschen-Back effect in the fine structures of hydrogen; for the mutually neighbouring components of the Balmer lines are members of different series (they are "*serienfremd*") (cf. Chap. VIII, § 4).

We next turn our attention to the theory. The most general point of view in the theory of spectra is that given by the **Principle of Combination**. There is no doubt that this principle must also hold for the

* Cf. E. Back, *loc. cit.*, Diss., p. 23.

† Cf. E. Kent in the work quoted on p. 361.

of resolution has already demonstrated its practical use and validity by allowing the rather uncertain denominators determined by Runge* on the one hand and by Takamine and Yamada† on the other to be corrected and reduced to smaller denominators.

It is advisable to make at this early stage a reservation about the exact formulation of the law. If r_1 and r_2 have common factors, then it does not follow from (5) that $r = r_1 r_2$ but that r is equal to the *smallest common multiple* of r_1 and r_2 . If r_1 and r_2 were known originally, then r would also be known *unambiguously* as the smallest common multiple. Actually, not r_1 and r_2 but r is originally given by observation; the reduction towards r_1 and r_2 is *not* then *unambiguous*. Let us consider an example that is important for the sequel. Suppose $r = 6 = 2 \cdot 3$. Then, by the law of resolution we could have (a) $r_1 = 2, r_2 = 3$; but we could just as well have (b) $r_1 = 1 \cdot 2, r_2 = 2 \cdot 3$. We shall see below how, by enlisting the aid of further observations, we may arrive at a means of deciding between (a) and (b).

Let us first consider *simple lines*. The Zeeman effect is normal for these, thus

$$r = 1.$$

From this it necessarily follows for each term that participates in the building up of simple lines that

$$r_1 = r_2 = 1.$$

We apply this statement to the s -term of any series systems whatsoever, which is, even in the case of doublet and triplet systems, always a simple term. We shall thus take as our starting-point that *the Runge denominator of the s -term is always equal to 1*.

We next consider *doublet systems*. We found for the combination (sp) of these in the H.S. and the II N.S. (cf. Fig. 96) that $r = 3$. Since we set r_1 equal to 1 for the s -term, we get unambiguously that $r_2 = 3$ for the Runge denominator of the p -term. Let us now consider the combination (pd). For these we had in Fig. 98 $r = 15$. This gives us a first test of our law of resolution: 15 is divisible by 3. From $r = 15$ and $r_1 = 3$ it follows that $r_2 = 5$. This conclusion is, however, no longer unambiguous. Thus $r_2 = 3 \cdot 5$ would also be compatible with $r = 15, r_1 = 3$. We shall, at any rate, try to do with the simpler assumption $r_2 = 5$. By extrapolating we get the following scheme for the *Runge denominator of the doublet terms*.

s	p	d	b	x	y	(7)
1	3	5	(7)	(9)	(11)	

The bracketed numbers have been extrapolated.

* Cf. the quotation on p. 385 and the essay by the author quoted in Note 1.
 † Proc. Tokio Math. Phys. Soc., 7, 277 (1913-1914).

We now turn to the triplet systems. For the combination (*sp*) we here have from Fig. 97 that $r = 2$. Since for the *s*-term we have again to set $r_1 = 1$ it follows unambiguously for the *p*-term that $r_2 = 2$. In the combination (*pd*), Fig. 99, r was equal to 6. Here again we have a test of our law of resolution: 6 is divisible by 2. It would at first sight appear right to conclude that the Runge denominator r_2 is equal to 3 for the *d*-term. When the author originally assumed this, he arrived at the following (as we shall see erroneous) scheme for the Runge denominators of the triplet-systems.

<i>s</i>	<i>p</i>	<i>d</i>	<i>b</i>	<i>x</i>	<i>y</i>
1	2	3	(4)	(5)	(6)

But the conclusion $r_2 = 3$ for the *d*-term is not the only possible one. As already remarked on page 391, we may also conclude from $r = 6$ and $r_1 = 2 = 1 \cdot 2$ (*p*-term) that $r_2 = 2 \cdot 3$ (*d*-term). We may decide between these two possibilities by arguing from the combination (*P'd*) between the simple terms and the triplet terms of the alkaline earths. Since here $r_1 = 1$ (*P*-term), the Runge denominator r of the combination necessarily becomes identical with the denominator r_2 of the *d*-term. For r we get from observation not the value 6 but the value 3. Thus we must make up our minds to drop the simplest assumption (*a*) of page 391 for the *d*-term, and must set for it $r_2 = 6 = 2 \cdot 3$. The combination (*dd'*) also compels us to do so, cf. page 368; the Runge denominators of its Zeeman pictures are likewise 6, and not 3.

We thus arrive at the following scheme for the triplet terms:

<i>s</i>	<i>p</i>	<i>d</i>	<i>b</i>	<i>x</i>	<i>y</i>	
1	1.2	2.3	(3.4)	(4.5)	(5.6)	(8)

The bracketing here also denotes extrapolation.

All this of course only holds for *weak* magnetic fields. For *strong* fields the Runge denominator must assume the value 1 throughout, both in the doublet as well as in the triplet systems.

A knowledge of the Runge denominators is, however, only the first step to the complete theory of the Zeeman effects. The explanation of the normal Zeeman effect by the theory of quanta must serve as a perfect example of the full theory. In this way we arrive at the following result (eqn. (12) on p. 239): through the magnetic field the original energy W_0 of the Kepler orbits became changed to

$$W = W_0 + mh \frac{\sigma}{2\pi} = W_0 + mh \Delta \nu_{norm} \quad (9)$$

The "magnetic quantum number" m is here equivalent to the "equatorial quantum number" n_1 which occurred earlier. Since n_1 was a part of the azimuthal quantum number n ($n = n_1 + n_2$), n_1 or m , respectively, is smaller than or at most equal to n . Furthermore, since the energy can undergo a decrease as well as an increase, depending on

the sense in which the Kepler orbit is traversed, we must allow the negative as well as the positive sign before m in (9). If we exclude the value $m = 0$ we have then $2n$ possible values for the magnetic quantum number, namely :

$$\pm (1, 2, \dots n) \quad (10)$$

and just as many possible positions of the corresponding "magnetic levels." To this there next comes into account the principle of selection (formulated on p. 300 for the equatorial quantum number) :

Change of the magnetic quantum number by ± 1 leads to circular, in the transverse effect, to linear polarisation *perpendicular* to the field.

Change of the magnetic quantum number by 0 leads to linear polarisation *parallel* to the field.

How is this to be extended on to the case of doublet systems? At first there will occur in place of Δv_{norm} in (9) $\frac{1}{r} \Delta v_{norm}$, where r is by (7) in general equal to $2n - 1$. Then the inner quantum number n_i will have to enter into (9) as the distinguishing characteristic of both doublet levels in (9). Starting from this, Landé[†] has succeeded in evolving the correct generalisation of (9) namely :

$$W = W_0(n_i) + mh \frac{n_i}{r} \Delta v_{norm} \quad (11)$$

Here the argument n_i of W_0 indicates that the original energy is different according as we consider the upper doublet level ($n_i = n$) or the lower one ($n_i = n - 1$). The magnetic quantum number m is to assume in (11) the following values in place of (10) :

$$\pm (1, 3, \dots 2n_i - 1) \quad (12)$$

The number of magnetic levels is thus not as before $2n$ but $2n_i$. Finally the rule of selection for m is to preserve its earlier form with the difference that now the quantum jump of 2 units is to take the place of the quantum jump of 1 unit, as is evident from a comparison of (10) with (12).

The content of eqn. (11) is illustrated in Fig. 100. The outer parts of the figure apply to weak fields which alone come into consideration at present, the left side referring to the terms $p_1 d_1$, the right to the terms $p_2 d_2$. The representation of the s -term has been placed in the middle ; it holds for strong as well as for weak fields.

* Following Bohr we proved on pages 246 and 310 that for hydrogen the zero level is forbidden. This exclusion does not in general extend to other models. Actually we shall have to allow the zero level for weak fields in the case of the triplet terms and altogether for strong fields.

† Zeitschr. f. Phys., 5, 231 (1921).

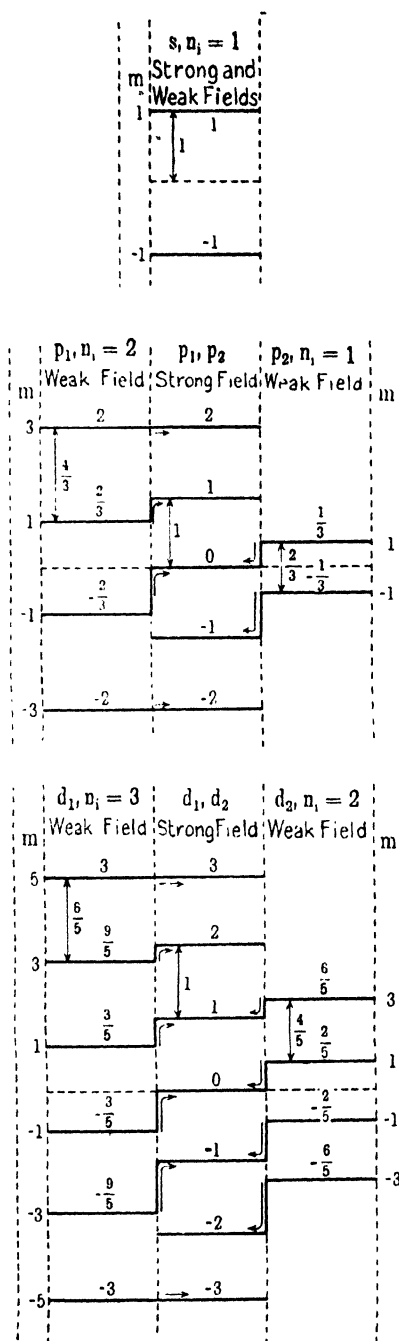

FIG. 100.

In the case of each term the magnetic levels are equidistant. Their distances from each other are, by (11), calculated in parts of $\Delta\nu_{norm}$:

2	4	2	6	4	8	6
	3	3	5	5	7	7

for the terms

$s, p_1, p_2, d_1, d_2, b_1, b_2,$

respectively.

To verify this hypothesis let us first deduce from it the type of resolution of the D-lines. Corresponding to the combinations sp_1 and sp_2 (D_2 and D_1), we follow Landé by writing in the upper rows of the following schemes for each value of m the corresponding magnetic level of the s -term, and in the lower rows the corresponding levels of the p_1 - or p_2 -term, respectively. If we form the difference of the numbers which stand one vertically *below* the other, we get the p -components (on account of $\Delta m = 0$). If we form the difference in an *oblique direction* in the schemes, downwards towards the right or left, we get the s components (on account of $\Delta m = \pm 2$). These differences are given in the lowest line of the schemes and are denoted according to their mode of origin by p (parallel) or s (perpendicular).

The result agrees, as we may convince ourselves, completely with the results of the observations expressed in Fig. 96.

In the same way we may obtain the resolution pictures in the I N.S., the combinations (p, d).

$m =$	-3	-1	+1	+3	
s		-1	+1		
p_1	-6	-2	+2	+6	
	-3	-3	+3	+3	
	+1 + $\frac{5}{3}$		- $\frac{1}{3}$ + $\frac{1}{3}$		-5
	s		p		s

$m =$	-1	+1	
s	-1	+1	
p_2	-1	+1	
	- $\frac{1}{3}$	$\frac{1}{3}$	
	+ $\frac{4}{3}$	- $\frac{2}{3}$	+ $\frac{2}{3}$
	s	p	s

To prevent the corresponding schemes from being overloaded, we shall write them down only for positive values of m and add only those for negative values that give rise to new components and not such as differ merely in sign. Accordingly we must suppose those with the reversed sign, added everywhere to the numbers of the lowest row as being those which would result from the same process if we were to complete the scheme in the direction of negative values of m .

m	...	-1	+1	+3	+5
p_1	...		+ $\frac{2}{3}$	+ $\frac{6}{3}$	
d_1	...	-3	+3	+9	+15
		-5	+5	+5	+5
		+ $\frac{19}{15}$ + $\frac{21}{15}$		$\frac{1}{15}$	$\frac{3}{15}$
		s		p	s

m	...	-1	+1	+3	
p_1	...		+ $\frac{2}{3}$	+ $\frac{6}{3}$	
d_2	...	-2	+2	+6	
		-5	+5	+5	
		16	24	4	12
		15	15	+15	+15
		s	p		s

m	...	-1	+1	+3
p_2	...	1	1	
d_2	...	3	3	
			+ $\frac{2}{5}$	+ $\frac{6}{5}$
			1	11
			15	15
		p	s	

These results, too, agree perfectly with observation (Fig. 98). And now we may, without trouble, write down the Zeeman types (that have not been observed) of the Bergmann lines. For example, we find for the combination (d_1b_1) , by extending the foregoing schemes appropriately:

p -components:	$\frac{1}{35}$	$\frac{3}{35}$	$\frac{5}{35}$		
s -components:	$\frac{35}{35}$	$\frac{37}{35}$	$\frac{39}{35}$	$\frac{41}{35}$	$\frac{43}{35}$
		$\frac{45}{35}$			

Here a limiting law already expresses itself, which holds for very high quantum numbers n and n_i , thus, for example (cf. p. 331), for the combination $(x, y), (yz) \dots$ in the limit $n \rightarrow \infty$, as the terms become more and more like those of hydrogen, the Zeeman effect also becomes increasingly like that of hydrogen; the p -components accumulate at the point 0, the s -components at the point 1 of the normal resolution.

To prove this we shall first change the form of eqn. (11). For the upper or lower level, respectively, of a doublet system we have

$$n_i = n, \frac{n_i}{r} = \frac{n}{2n-1} = \frac{1}{2} \left(1 + \frac{1}{2n-1} \right),$$

$$\text{or, respectively, } n_i = n-1, \frac{n_i}{r} = \frac{n-1}{2n-1} = \frac{1}{2} \left(1 - \frac{1}{2n-1} \right).$$

Furthermore, we write for the upper or lower level

$$W_0(n) = W + \frac{1}{2} h \Delta v_0,$$

$$\text{or, respectively, } W_0(n-1) = W - \frac{1}{2} h \Delta v_0,$$

so that W denotes the level which bisects the two original ones, and Δv_0 denotes the original doublet-difference. We then get from (11)

$$W = W \pm \frac{1}{2} h \Delta v_0 + \frac{1}{2} m h \left(1 \pm \frac{1}{2n-1} \right) \Delta v_{norm}. \quad (13)$$

It is to be noted that the inner quantum number has dropped out, and has been replaced by a plus or minus sign. We shall later return to consider the importance of this circumstance.

Let us next consider the transition $n+1 \rightarrow n$ in the case of a very great n . We get the p -component if we give m the same value in both terms. Calculated in units of Δv_{norm} , its resolution will be, by (13) :

$$+ \frac{1}{2} m \left(\frac{1}{2n+1} - \frac{1}{2n-1} \right) = \mp \frac{m}{4n^2-1}. \quad (13a)$$

This is equal to zero when $m = 1, 2, \dots, n$ and $n = \infty$. The s -components come about if we make m jump by 2 units, for example, from $m+2$ to m . From (13) there then results :

$$\left. \begin{aligned} & \frac{1}{2} (m+2) \left(1 \pm \frac{1}{2n+1} \right) - \frac{1}{2} m \left(1 \pm \frac{1}{2n-1} \right) \\ & = 1 \pm \frac{1}{2n+1} \mp \frac{m}{4n^2-1} = 1 \text{ for } m = 1, 2, \dots, n, \text{ and } n = \infty \end{aligned} \right\} (13b)$$

In the limit $n = \infty$, therefore, the *normal Zeeman effect*, as stated, arises, both as regards the position of the p -components as that of the s -components.

It is true that this result holds only if in deriving (13a, b) we take for the two terms (13) that are to be subtracted from each other either

the upper or the lower sign, as we tacitly did, but not if we take the upper sign in the one case, and the lower in the other. That is to say: the normal Zeeman effect presents itself asymptotically when two upper or two lower doublet levels are combined, and this combination gives rise to a *principal line* of the line configuration in question (cf. p. 360). But in the combination of an upper doublet level with a lower one, which leads to the satellite of the line-configuration under consideration (cf. p. 365) the Zeeman effect does not contract asymptotically to the normal position of the *p*- and the *s*-component, but becomes diffuse. Nevertheless, the law formulated above may be maintained because we may assume, on the ground that the similarity with the hydrogen type increases, that the intensity of the satellite and its resolution picture decreases more and more to zero as *n* increases.

We next turn to the triplet systems by imagining, as above, a "weak" magnetic field to be acting. The magnetic levels of the terms have in this case, too, been determined by Landé (*loc. cit.*) by means of a fortunate generalised résumé of the empirical resolutions.

The Runge denominator of the triplet systems (cf. p. 392) was $r = n(n - 1)$. But it actually has this value only in the case of the most central triplet component; in the case of the two outer triplet components it becomes reduced to *n* or *n - 1*, respectively, and this is, of course, no contradiction to the assertion that the common denominator of the triplet is $n(n - 1)$. To write down the general formula for the energy, we do best by starting from (13), but we write it separately for each of the three triplet levels:

$$W = \begin{pmatrix} \bar{W}_1 + mh \left(1 + \frac{1}{n} \right) \Delta\nu_{norm} \\ \bar{W}_2 + mh \left(1 - \frac{1}{n} + \frac{1}{n-1} \right) \Delta\nu_{anom} \\ \bar{W}_3 + mh \left(1 - \frac{1}{n-1} \right) \Delta\nu_{norm} \end{pmatrix} \quad (14)$$

The triplet here appears in a certain sense as a configuration of two doublets that have been combined. On account of the change of sign \pm it is seen from analogy with (13) that ($W_1 W_2$) actually form a first doublet, and ($W_2 W_3$) a second doublet. The differences of frequencies when the field is free (that is, when no magnetic field is acting), which we denoted on page 371 by $\Delta\nu^{12}$ and $\Delta\nu^{23}$, are determined from the quantities W_i in (14) as follows:—

$$\left. \begin{aligned} \Delta\nu^{12} &= \frac{\bar{W}_1 - \bar{W}_2}{h} \\ \Delta\nu^{23} &= \frac{\bar{W}_2 - \bar{W}_3}{h} \end{aligned} \right\} \quad (15)$$

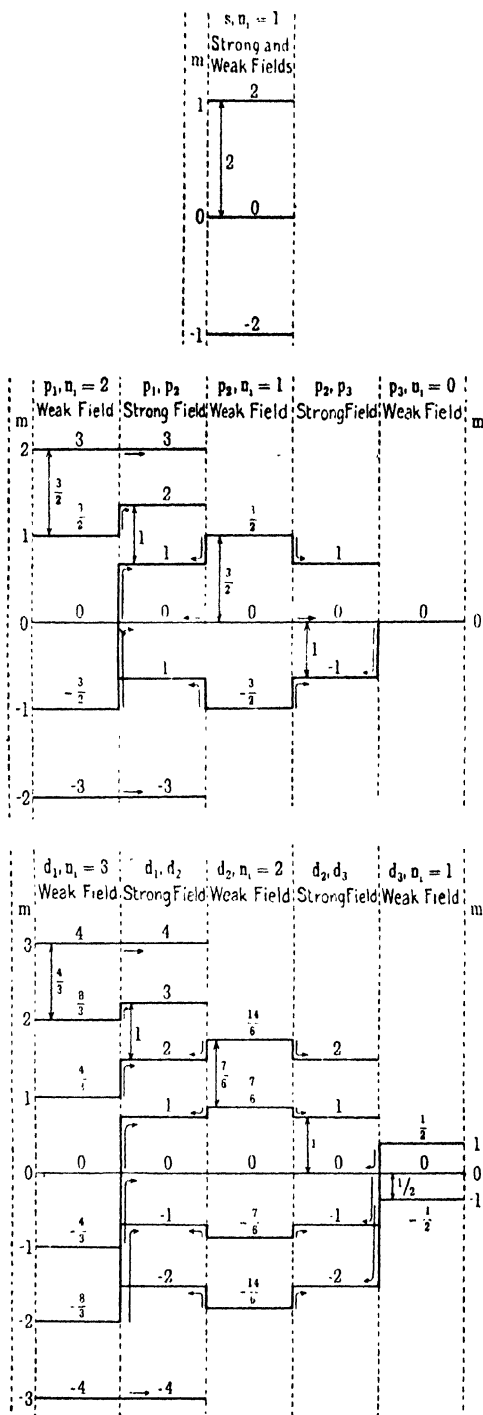

$m =$...	0	1	2	
s	...	0	2		
p_1	...	0	3	3	
		2	0	$\frac{1}{2}$	$-\frac{3}{2}$ -1
	s		p		s

$m =$...	0	1			$m =$...	0	1
s	...	0	2	3		s	...	0	2
p_2	...	0	2			p_3	...	0	
		2	(0)	1	$-\frac{3}{2}$			2	0
	s		p		s		s		p

The result contained in the lowest rows again agrees fully with the earlier data of Fig. 97, with one exception: in the combination (sp_2) the p -component (0) that is bracketed in our table is *not real*; it is not actually observed. This component corresponds to the transition $0 \rightarrow 0$ of m ; the simultaneous transition of n_i is $1 \rightarrow 1$. Just as earlier (p. 367) we forbade the inner quantum number to undergo the transition $0 \rightarrow 0$ so we must now also forbid the magnetic quantum number to undergo the transition $0 \rightarrow 0$, but only when the inner quantum number simultaneously remains unchanged.* It is to be noted that according to this the transition $0 \rightarrow 0$ in the case of the combinations (sp_1) and (sp_3), m is not forbidden to undergo the transition $0 \rightarrow 0$, and this has actually been observed.

We shall not write down the resolution pictures for the combinations (p_1d_j); they, too, agree fully with observation (Fig. 99). We merely mention that in the combinations (p_1d_2) and (p_2d_3) our supplementary rule is also shown to hold good, inasmuch as here the transitions $0 \rightarrow 0$ of m become unreal (or virtual) in accordance with observation. Likewise, we shall refrain from extrapolating our scheme for the case of the Bergmann lines. The law that was enunciated for doublets on page 396, and according to which the anomalous effect asymptotically approaches the normal effect in the principal lines of the higher term-combinations, may be extended unchanged to triplet systems.

On the other hand, we must briefly enter into the question of the important combinations between simple and triplet terms. Of course, the simple terms S, P, D . . . are subject to normal resolution. But, according to page 368, they have an inner quantum number that differs from

* Landé, *loc. cit.*

the azimuthal one, namely, 0, 1, 2, . . . or generally $n_i = n - 1$. Since in their case, too, we suppose the magnetic quantum number to be restricted by the rule (15), the number of their magnetic levels will be reduced as compared with the normal case. As an example, we regard the combination (Sp_2) ($\lambda = 2537$ in the case of Hg). On account of $n_i = 0$ the term S has only the one magnetic level 0; the magnetic levels of p_2 are given in Fig. 101. We get as the combination of these two the so-called " $\frac{3}{2}$ -Type," which is well known experimentally, and is distinguished by its simplicity, according to the following scheme*:

$m =$	- 1	0	+ 1
S		0	
p_2	- 3	0	+ 3
	- 2		+ 2
	+ 3	0	- 3
	+ 2		- 2
	s	p	s

A comparison with the combination (sp_2) on page 399 is instructive: since the magnetic level $m = 1$ is missing in the term S, the p -components $\frac{1}{2}$ and the s -components 2 drop out from the resolution picture. Since, on the other hand, the inner quantum number in (Sp_2) performs the transition $0 \rightarrow 1$, that is, does not remain unaltered as in the case of (sp_2), the middle component 0 actually occurs as a real component.

In the same way the schemes of the combinations (Pd_2), (Pd_3), (p_1D), (p_2D), that, according to page 367, are not forbidden, may be written down. According to a communication by Paschen to the author, they, too, agree with observation.

All in all, we may assert that, in virtue of inner quantum numbers, of the magneto-optical law of resolution, and of Landé's energy-levels, we have a practical mastery over the extensive realm of the anomalous Zeeman effects for weak fields.

We next come to the *strong* fields, that is, to the *Paschen-Back effect*. Here we have for the special case of the D-line type a phenomenological theory by Voigt† which seems to meet the facts correctly at least qualitatively. Voigt's theory signifies for the anomalous effect, in particular that of the D-lines, what Lorentz's theory denotes for the normal effect.

Like Lorentz's theory, Voigt's assumes quasi-elastically bound electrons capable of vibrating, and, corresponding to the ratio of the intensities

* Landé, *Physikal. Zeitschr.*, **22**, 417 (1921).

† W. Voigt, *Ann. d. Phys.*, **41**, 403 (1913), and **42**, 210 (1913). Cf. also the simplified form of Voigt's theory due to Sommerfeld, *Göttinger Nachr.*, March, 1914, as also Hilbert-Festschrift, 1922 (of which a reprint is about to appear in the *Zeitschr. f. Phys.*, 1922). Voigt deals with the process of absorption, Sommerfeld with that of emission.

$D_1 : D_2$, it assumes one electron with the original frequency D_1 , and two with the frequency D_2 . Their motions are linked together by the magnetic field in a peculiar way. The equations of vibration are set down independently and differently from each other for the components that are parallel and perpendicular to the magnetic field. From them we calculate the vibration numbers as functions of the ratio

$$v = \frac{\Delta\nu_0}{\Delta\nu_{norm}} \quad \dots \quad (17)$$

where $\Delta\nu_0$ denotes the original difference between the frequencies of D_1 and D_2 . Since $\Delta\nu_{norm}$ is proportional to the magnetic field, v gives us an inverse measure of the magnetic intensity of field. Great values of v denote "weak" fields, small values denote "strong" fields, in the sense of page 388. The $\Delta\nu$'s calculated according to Voigt give for great values of v the resolution picture shown in Fig. 96; for small values of v they give the normal Paschen-Back effect, and also represent within the limits of errors of observation the process of transformation from the one type to the other when the fields are intermediate between "weak" and "strong." *

To translate Voigt's formulæ into the language of quanta we have to deduce, according to the series scheme of the D-lines, $\nu = 1s - 2p_i$, the resolutions of the terms $1s$ and $2p_i$ from the resolutions $\Delta\nu$ of the lines. The resolution of $1s$ is the normal one; hence, in subtracting the resolution $\Delta\nu_{norm}$ of the s -term from Voigt's $\Delta\nu$ of the lines, we get the resolution of the two p -terms, and, indeed, we get it for the various magnetic quantum-numbers $m = \pm 1, \pm 3$, which, according to page 395, come into consideration for the D-lines. Since we can determine each individual p -level from one parallel and one perpendicular component of the resolution picture, we get for the position of each level two determinations that are identical with and check each other. The result may be compressed into the simple formula:

$$W = \bar{W} + \frac{h}{2} \left(m \pm \sqrt{1 + \frac{2}{3}mv + v^2} \right) \Delta\nu_{norm}$$

Here the upper sign applies to the energy-levels p_1 , the lower to p_2 ; in the first case, m runs through the values $m = \pm 1, \pm 3$, in the second, the values ± 1 .

It signifies only a slight generalisation if we make use of the corresponding formula for all terms and replace the Runge denominator under the square root by $r = 2n - 1$, thus:

$$W = \bar{W} + \frac{h}{2} \left(m \pm \sqrt{1 + \frac{2mv}{2n-1} + v^2} \right) \Delta\nu_{norm} \quad \dots \quad (18)$$

* Cf., for example, the work by Kent, mentioned on page 361.

We next test this formula for weak fields, $v \ll 1$. We then have

$$\sqrt{1 + \frac{2mv}{2n-1} + v^2} = v \left(1 + \frac{m}{2n-1} v + \dots \right),$$

$$\sqrt{1 + \frac{2mv}{2n-1} + v^2} \Delta v_{norm} = \Delta v_0 + \frac{m}{2n-1}$$

and hence, by (18),

$$W = \bar{W} \pm \frac{1}{2} h \Delta v_0 + \frac{1}{2} \left(1 \pm \frac{1}{2n-1} \right) \Delta v_{norm}.$$

This has brought us back to eqn. 13 on page 396; hence all the resolution-pictures there deduced also obey our general eqn. (18).

On the other hand, for strong fields, that is $v \gg 1$, eqn. (18) gives directly

$$W = \bar{W} + h \frac{m \pm 1}{2} \Delta v_{norm}. \quad (19)$$

Since m was an *odd* number in the case of the doublet-systems, $\frac{m \pm 1}{2}$ will be an *even* number. Thus eqn. (19) asserts that the resolution becomes normal for strong fields. At the same time it tells us how the anomalous energy-levels of the weak fields are related to the normal levels of the strong fields and pass over into them. This is represented for the p - and d -terms by the middle columns in Fig. 100. The arrows that have been inserted indicate in which sense the anomalous levels must be displaced if they are finally to become normal levels. A glance at the figure tells us that the whole Paschen-Back effect consists only in a mostly trifling smoothing out and adjustment of the energy-levels. Those levels that are from the outset normal remain normal; these are the two levels of the s -term and the two outermost levels of the p_1 - and d_1 -terms. For all of these, $|m| = 2n - 1$ holds. Hence from eqn. (18) it follows that

$$W = W + \frac{h}{2} (\pm |m| + (v \pm 1)) \Delta v_{norm},$$

$$= \bar{W} + \frac{1}{2} h \Delta v_0 \pm h \frac{|m| + 1}{2} \Delta v_{norm}.$$

This again denotes the normal Zeeman effect, and indeed for all values of v .

We now come to the *triplet systems*. A vibration theory has not been worked out for these. We can, therefore, describe the transition from weak to strong fields only qualitatively and not quantitatively. This is done by means of the arrows in the second and fourth columns of Fig. 101, which have been drawn from analogy with Voigt's formulae for the doublet systems. Levels that were naturally normal remain so here again, and are unaffected by the transformation (the zero-levels are

an exception to this). The Paschen-Back effect again consists purely in a systematic smoothing out of the originally anomalous energy-levels.

A noteworthy feature in this process is that levels which have been normalised in this way do not always bear the magnetic quantum-number that corresponds to their resolution. From a comparison of the first and second columns for the d -terms in Fig. 101 it follows, for example, that the normal level $+1$ (second column) arises from the level 0 (first column) and hence also bears the same quantum-number $m = 0$ as the latter. As a matter of fact we may imagine the transition from weak to strong fields to be carried out adiabatically so that the quantum-numbers remain preserved in principle. In the same way the normal level 0 (second column) arises from the level $-\frac{4}{3}$ (first column), and accordingly also receives its quantum-number $m = -1$. *The levels of the multiple terms that have been normalised by the Paschen-Back effect are thus in general displaced, as regards their quantum-numbers, relatively to the originally normal levels such as would belong to the simple terms.*

For example, we recognise a confirmation of this curious displacement in the "partial Paschen-Back effect" (cf. p. 389), which has been observed by Back,* in the I N.S. of Mg. The d -differences are so small in the case of Mg that any perceptible magnetic field must be considered "strong" in comparison with them. Accordingly we write the formula of the Mg lines in question, $\lambda = 3838, 3832, 3830$, not as $\nu = 2p_i - 3d_i$, but as $\nu = 2p_i - 3d$ (cf. p. 389), but notice, in doing so, that the magnetic quantum-numbers of the normalised d -term that has artificially become simple differ from those of an originally simple term in the sense of the displacement mentioned just above. In the following table there are written under the m -values of the upper row the resolutions of the terms p_i when the field is weak, and in the next three rows the resolutions of the three d -terms when the fields are strong. The brackets above the table indicate that the term p_1 consists of five, the term p_2 of three levels, and the term p_3 of only one zero-level. The magnetic levels of the d -terms are indeed all integral (normal), but are in general displaced with respect to the scale of the m 's (the levels of an originally simple term). We next prove the effect of this in the resolution-pictures of the individual combinations ($p_i d$).

Let us first consider ($p_3 d$). Out of the zero-level of p_3 together with the d -levels $1, 0, -1$ vertically beneath it there arise the

$$p\text{-components } 0, \pm 1.$$

If, on the other hand, we proceed from the same zero-level to the d -levels at the right or left of the middle, there arise the

$$s\text{-components } 0, \pm 1, \pm 2.$$

Exactly this resolution-picture has actually been observed by Back.

* Naturwissenschaften, 1921, 12 Heft, Tab. 4.

		p_1						
					p_2			
						p_3		
$m =$		- 3	- 2	- 1	0	+ 1	+ 2	+ 3
p_i	. . .		- 3	- $\frac{3}{2}$	0	+ $\frac{3}{2}$	+ 3	
d	$\left\{ \begin{array}{l} d_1 \\ d_2 \\ d_3 \end{array} \right.$. . .	- 4	- 1	0	+ 1	+ 2	+ 3
	. . .		- 2	- 1	0	+ 1	+ 2	+ 4
	. . .			- 2	- 1	0		

In the case of the combination (p_2d) we correspondingly get from the three middle rows of the scheme the

$$p\text{-components } (0), \pm \frac{1}{2}, \pm 1 \left(\pm \frac{3}{2} \right),$$

and, by combining with the neighbouring rows on the right and left, the

$$s\text{-components } 0, \pm \frac{1}{2}, \pm 1, \pm \frac{3}{2}, \pm 2 \left(\pm \frac{5}{2} \right).$$

This type, too, in particular, as regards the drawing together of the p - and s -components, agrees with the observations of Back: only the bracketed components are missing in the observations, and this is obviously due to their too feeble intensity, and is formally explained by the principle of correspondence.

Finally, the combination (p_1d) gives the p -components:

$$0, \pm \frac{1}{2}, \pm 1, \left(\pm \frac{3}{2} \right), \left(\pm 2 \right),$$

and the s -components:

$$0, \pm \frac{1}{2}, \pm 1, \pm \frac{3}{2}, \pm 2, \left(\pm \frac{5}{2} \right), \left(\pm 3 \right).$$

This, too, agrees with observation, with the exception of the additional bracketed components.

The combination (p_3d) is particularly instructive. Although in this case we connect the normal zero-level of p_3 with the normalised levels of the d -term, the normal triplet $0(p), \pm 1(s)$ does not arise, but the quintet $0(p, s), \pm 1(p, s), \pm 2(s)$ appears. This is purely a consequence of the displacement of the normalised level relative to its natural position. If, on the other hand, we had combined the zero-level of p_3 with entirely normal d -levels, we should clearly have obtained only the normal triplet, namely $0 - 0$ as a p -component, and 0 ∓ 1 as s -components.

The circumstances are quite similar in the case of the partial Paschen-Back effect of the doublet systems, for example, in the case of Na, $\nu = 2p_i - 4d$, a result which Mr. Back has kindly communicated to the author.

Looking back we may say that for strong fields, too, our account, which is a mixture of the quantum theory and of a phenomenological

theory of vibration, has fared remarkably well. The extrapolation of Voigt's equations has been shown to be fully trustworthy, in particular in the case of the doublet systems. There is no doubt that this fruitfulness of Voigt's theory as extended in this way is ultimately due again to the general correspondence between the quantum theory and the classical theory of radiation, which has been so happily formulated by Bohr.*

* The thanks of the author are due to Mr. W. Heisenberg for kindly collaborating in the above treatment. It is due to him, too, that the author has found it possible in the following addendum, to solve the problem of the anomalous Zeeman effects and of the term-multiplicities, on which they are founded, on the basis of Bohr's model.

ADDENDUM

WE use the following picture to represent diagrammatically a *doublet atom*, that is, an atom out of the first or third group of the periodic system or an ionised atom out of the second group, and so forth: an outer valency electron, comparatively far removed from the remainder of the atom, and an atomic trunk, which comprises the rest of the atom and that is treated as forming a whole, are coupled together by the internal atomic magnetic field H_i ,* which arises through the revolution of the valency electron about the atomic trunk. If μ is the magnetic moment of the atomic trunk, due to the circulations of its inner electrons, and if θ is the angle between H_i and the axis of μ , then the effective part of the magnetic energy corresponding to this coupling is:

$$\mu H_i \cos \theta \quad . \quad . \quad . \quad . \quad . \quad (20)$$

We make the following fundamental assumption, which is justified by its success: when the valency electron is in the ground orbit $1s$ the atom has the total impulse † 1, and, *averaged for time, this is shared equally between the valency electron and the atomic trunk*, so that each has the mean moment of momentum $\frac{1}{2}$. If the valency electron is removed to a p - or a d -orbit, its moment increases by 1 or 2 . . . units, that is, now amounts to $\frac{3}{2}$, $\frac{5}{2}$ or in general to $n - \frac{1}{2}$, where n is taken as the azimuthal quantum number we used earlier. The moment of the atomic trunk hereby retains its value $\frac{1}{2}$ as regards magnitude; how it behaves with regard to direction will be decided by systematic calculations below.

From this starting-point we next get a revision of the nomenclature and view of quantum numbers that we have hitherto adopted. The total quantum of the motion of the valency electron (current number of the series term, sum of the azimuthal and radial quantum) is an integral number, as is shown by the series representation. On the other hand, the phase integrals that belong individually to the azimuthal and radial motion are half-numbers. If we call the numbers in question n^* and n'^* , then by our above remark $n^* = n - \frac{1}{2}$; on the other hand, we have to demand that $n'^* = n' + \frac{1}{2}$, in order that the sum $n^* + n'^*$ may remain

* In a note of Nov., 1916 (Bayer, Akad.) the author has considered the magnetic action of an electron that circulates in the *interior* of the trunk upon the outer electron and has shown that this is to be neglected in the series representation. What we are dealing with in the text is the opposite action.

† Here and in the sequel we express the moment of momentum in terms of the unit $h/2\pi$.

equal to the whole number $n + n'$. The total moment of momentum of the atom is determined by the geometrical sum of the moment of momentum of the outer electron and of that of the atomic trunk. When no external magnetic field acts, then, as we shall show, the axes of both moments of momentum are in the same sense or parallel to one another in the opposite sense, and the total impulse of the atom becomes

$$n - \frac{1}{2} \pm \frac{1}{2} = \left\{ \begin{matrix} n \\ n - 1 \end{matrix} \right\} = n_i. \quad . \quad . \quad . \quad (21)$$

Thus, as Landé first stated, *our inner quantum number n_i has the significance of the total moment, and its two different values correspond, in the case of the doublet atom, to the two different possible ways of circulating of the atomic trunk. The principle of selection for the inner quantum number n_i is, in view of this, according to Rubinowicz directly intelligible, indeed more so than the principle of selection for the azimuthal quantum number n .*

From the mechanical moment of momentum we get the corresponding magnetic moment of the circulation of the electron (cf. p. 249) by multiplying the former by $e/2mc$. Consequently, the magnetic moment of the atomic trunk or of the valency electron, if we now insert the hitherto suppressed factor $h/2\pi$ becomes, respectively :

$$\frac{1}{2} \cdot \frac{e}{2mc} \cdot \frac{h}{2\pi} \quad \text{or} \quad n^* \cdot \frac{e}{2mc} \cdot \frac{h}{2\pi} \quad . \quad . \quad . \quad (22)$$

According to this, then, the magnetic moment of the atomic trunk becomes equal to half that of a Bohr magneton.

We now impose an external magnetic field H . Let this form an angle θ_1 or θ_2 , respectively, with the axes of the mean moment of momentum of the valency electron or the atomic trunk. If θ , as in (20), is the angle between the latter two axes, then, by the cosine law,

$$\cos \theta = \cos \theta_1 \cos \theta_2 + \sin \theta_1 \sin \theta_2 \cos (\gamma_1 - \gamma_2) \quad . \quad (23)$$

where the angles γ_1 and γ_2 determine the position of the "*Knotenlinie*" in the plane perpendicular to H for the mean orbital plane of the valency electron or of the atomic trunk respectively. We imagine the angle θ_1 to be fixed by "spatial quantising." Thus, besides the moment n^* of the valency electron, also its component in the direction of H can assume only discrete values. We designate these values* by m^* ("magnetic quantum number") and assume them to be like n^* , half integers. Then we have in complete analogy with the spatial quantising of the hydrogen orbits (eqn. (6) on p. 244) :

$$m^* = n^* \cos \theta \quad . \quad . \quad . \quad . \quad (24)$$

* Our earlier magnetic quantum number m of the doublet systems was twice the present m^* . Whereas the earlier one assumed the values $\pm (1, 3, 5, \dots, 2n - 1)$, our present m^* assumes the values $\pm (\frac{1}{2}, \frac{3}{2}, \dots, n^*)$.

On the other hand, we shall determine the angle θ_2 by the postulate that the axis of the atomic trunk is to assume the direction of the resultant of the external field H and of the inner atomic field H_1 .

The magnetic energy of the whole doublet atom is composed of the following three parts:—

1. The magnetic energy of the valency electron in the field H [see eqns. (20), (22), (24), and (1)]:

$$\mu_1 H \cos \theta_1 = n^* \cdot \frac{e}{2mc} \cdot H \cos \theta_1 = n^* \cdot \frac{e}{m} \cdot \frac{hH}{4\pi c} = n^* h \Delta\nu_{norm}$$

2. The magnetic energy of the atomic trunk in the field H [see eqns. (20), (22), and (1)]:

$$\mu_2 H \cos \theta_2 = \frac{1}{2} \cdot \frac{e}{2mc} \cdot \frac{h}{2\pi} \cdot H \cos \theta_2 = \frac{1}{2} \cos \theta_2 h \Delta\nu_{norm}$$

3. The mutual magnetic energy between the valency electron and the atomic trunk [see eqns. (20) and (1)]:

$$\mu_2 H_1 \cos \theta = \frac{1}{2} \cdot \frac{e}{2mc} \cdot \frac{h}{2\pi} \cdot H_1 \cos \theta = \frac{1}{2} \cdot \frac{H_1}{H} \cos \theta h \Delta\nu_{norm}$$

If we add, further, an amount W as energy that is not of magnetic origin, we get as the total energy, if we substitute for $\cos \theta$ from (23) and set $\frac{H_1}{H} = v$:

$$W = \bar{W} + h(n^* + \frac{1}{2}X)\Delta\nu_{norm} \quad . \quad . \quad . \quad (25)$$

in which we have used the abbreviation

$$X = \cos \theta_2 + v[\cos \theta_1 \cos \theta_2 + \sin \theta_1 \sin \theta_2 \cos(\gamma_1 - \gamma_2)] \quad . \quad (26)$$

The postulate that the atomic trunk is to adjust itself in the magnetic field requires that:

$$\frac{\partial W}{\partial \gamma_2} = \frac{\partial W}{\partial \theta_2} = 0.$$

From this it follows, on the one hand, that

$$\sin(\gamma_1 - \gamma_2) = 0 \quad . \quad . \quad . \quad . \quad (27)$$

that is, "the magnetic axis of the atomic trunk and the orbit of the valency electron lie in a plane which contains the field direction H ;" and, on the other hand, a condition for θ_2 follows from which we get after a simple calculation

$$X^2 = 1 + 2v \cos \theta_1 + v^2 \quad . \quad . \quad . \quad . \quad (28)$$

If we now use eqn. (24) and insert (28) in (25), we get

$$W = \bar{W} + h\left(n^* \pm \frac{1}{2}\sqrt{1 + 2\frac{m^*v}{n^*} + v^2}\right) \cdot \Delta\nu_{norm} \quad . \quad (29)$$

which agrees exactly with eqn. (18). As we saw above that the facts of the whole magneto-optics of doublet systems arise out of this equation, these facts are now also explained in terms of the atomic model.

Pictorially our deduction of eqn. (29) teaches us the following: The orbit of the valency electron is fixed with respect to the external magnetic field by spatial quantising. The atomic trunk adjusts itself into the direction of the resultant of the external and the inner atomic magnetic field, that is, it lies in general obliquely to the external magnetic field. Only when the latter field is strong compared with the inner atomic field, does the atomic trunk take the exact direction of the external field. Then the final result of the Paschen-Back effect is attained and we get appreciably normal resolution.

As a bye-product of these considerations we, of course, get the *explanation of the doublets in a free field* (no external magnetic field) *on the basis of the atomic model*. These doublets correspond to the difference in the mutual energy of the valency electron and the atomic trunk in the two opposite motions of the latter. The distance between the doublets becomes (as also follows from eqn. (29) for $v = \alpha$):

$$\Delta\nu_{00} = \frac{e}{m} \cdot \frac{H_i}{4\pi c}$$

By calculating the magnetic action H_i of a definite *p*- or *d*-orbit of the valency electron at the focus of the orbit, whereby we have now to take account of the present mechanical significance of the quantum numbers (n^* , n'^* in place of n and n'), we get for Li

$$\Delta\nu_p = 0.32 \text{ cm.}^{-1}, \quad \Delta\nu_d = 0.035 \text{ cm.}^{-1}.$$

This agrees excellently with our data on page 361. In the case of the heavier elements the extension of the atomic trunk is to be taken into consideration, and hence the calculation of H_i at the focus of the orbit no longer suffices. This circumstance brings with it the increase of the doublet difference with increase of atomic number, with which we are acquainted from page 371.

In spite of the striking agreement between the theoretical and the observed doublet interval for Li we should scarcely need to regard our model of the doublet atoms as inevitable, if it were not linked up with the whole realm of the Zeeman effect for doublets. But inasmuch as formula (18), which has been obtained empirically or half empirically, may be deduced accurately from our model of doublet atoms, our explanation of the doublets in a free field seems quite assured.

We shall only briefly sketch the corresponding theory of *triplet atoms*. According to the cross law we have here an even number of outer electrons of which *two* are favoured as valency electrons, one being the *inner* and the other the *outer* valency electron. For the unexcited state we distribute an impulse 1 in each case in the mean equally between the

atomic trunk and each of the two valency electrons. Here two cases are possible: the two impulses *1 are of opposite or of the same sign.*

1. In the first case the atomic trunk receives the impulse

$$+ \frac{1}{2} + \left(- \frac{1}{2} \right) = 0.$$

The inner valency electron receives, say, $-\frac{1}{2}$, and the outer $+\frac{1}{2}$, or, in the excited state, $n - \frac{1}{2}$. This is the case of the *simple terms*. The sum of the moments becomes $n - 1$, that is, again n_i , cf. page 367; the Zeeman effect becomes normal because the atomic trunk does not respond magnetically since its magnetic moment is zero. In particular, it is highly satisfactory that the ground-orbit S of the triplet atoms is distinguished by the value $n_i = 0$ of the total moment of momentum.

2. In the second case which we must ascribe to the true *triplet terms* the atomic trunk has the moment of momentum

$$+ \frac{1}{2} + \frac{1}{2} = 1,$$

and each of the two valency electrons is associated in the unexcited state (*s-term*) with the momentum $+\frac{1}{2}$. In the excited state the momentum of the external valency electron becomes increased to $n - \frac{1}{2}$, whereas those of the inner valency electron and the atomic trunk retain the values $\frac{1}{2}$ and 1 respectively. The mutual adjustment and the possible eventuality of a change of sign must be obtained from the exact investigation of their adjustment in an external magnetic field H.

Let us make the approximate assumption, which is without doubt justified, that the inner valency electron is perfectly rigidly coupled to the atomic trunk; thus let us characterise its position by the common angle θ_2 and treat the sum of its moments of momentum, $1 + \frac{1}{2} = \frac{3}{2}$, as one quantity. Let us, on the other hand, determine the position of the valency electrons by means of spatial quantising, in such a way that the sum of the components of its moments of momentum in the direction of the field H is capable of assuming only the discrete values m ($m =$ "magnetic quantum number" = integer). Then the following relation holds:—

$$\frac{1}{2} \cos \theta_2 + n^* \cos \theta_1 = m \quad . \quad . \quad . \quad (30)$$

By summing up the individual amounts of energy, as enumerated on page 408 and using (30), we now get:—

$$W = W + h(m + X)\Delta v_{norm} \quad . \quad . \quad . \quad (31)$$

in which X has the same meaning as in (26) except that in place of v we now have $3v/2$. If we next postulate that the complex consisting of the atomic trunk and the inner valency electron is again to adjust itself into the direction of the resultant of the fields H and H_i , there follows from this and from eqn. (30) a *cubic equation* in X. Two of its

roots are given by the two outer levels of the triplet; the middle level may be brought into relation with them rationally. For weak external fields ($H \ll H_c, v \ll 1$) they are given by

$$W = \begin{cases} \bar{W} + h \left[\frac{3v}{2} + m \left(1 + \frac{1}{n} \right) \right] \Delta v_{norm}, \\ \bar{W} + h \left[-\frac{3}{4} \frac{v}{n^*} + m \left(1 - \frac{1}{n} + \frac{1}{n-1} \right) \right] \Delta v_{norm}, \\ \bar{W} + h \left[-\frac{3}{2} v + m \left(1 - \frac{1}{n-1} \right) \right] \Delta v_{norm}. \end{cases} \quad (32)$$

These equations agree exactly with eqn. (14) as far as the coefficients of m are concerned. Hence, like the latter equations, they represent the anomalous Zeeman effects of the triplet systems for weak fields completely and correctly. We merely mention in passing that the cubic equation may also be manipulated approximately for strong fields, and that it then gives energy-levels that represent the Paschen-Back effect correctly.

We next compare those parts of eqns. (32) and (14) that do not involve m . We get in this way

$$\begin{aligned} \bar{W}_1 &= \bar{W} + \frac{3}{2} v h \Delta v_{norm}, \\ \bar{W}_2 &= \bar{W} - \frac{3}{4} \frac{v}{n^*} h \Delta v_{norm}, \\ \bar{W}_3 &= \bar{W} - \frac{3}{2} v h \Delta v_{norm}. \end{aligned}$$

From these it follows by eqn. (16) that for triplet-differences when no field is present

$$\begin{aligned} \Delta v^{12} : \Delta v^{23} &= \frac{3}{2} \left(1 + \frac{1}{2n^*} \right) : \frac{3}{2} \left(1 - \frac{1}{2n^*} \right) \\ &= 2n^* + 1 : 2n^* - 1 = n : n - 1 \end{aligned} \quad (33)$$

This is highly significant, and states that: *In the case of the p-term the ratio of the triplet-differences is to be 2 : 1, for the d-term it is to be 3 : 2, and for the b-term 4 : 3.* Table 41 on page 371 shows in its last two columns how exactly this deduction of the theory is confirmed by observation for low atomic numbers: Saunders' measurements (mentioned on p. 362) of the triplets of the Bergmann lines of Ba also agree well with our deduction within the limits of error. The fact that in the case of higher atomic numbers departures from the ideal values come about is explained, as above for doublet atoms, by the extension of the inner atomic complex of which we took no account in our calculation.

The pictorial meaning of our three triplet-levels is as follows: the middle path of the outer valency electron is in general inclined to the momental plane of the inner complex, atomic trunk + inner valency

electron. The angle of inclination of both components of the triplet atom has the three values (when no external field is present).

$$\cos \theta = +1, \quad \cos \theta = \frac{0^*}{n^*}, \quad \cos \theta = -1.$$

Here 0^* denotes the number $0 + \frac{1}{2}$ just as n^* denoted $n + \frac{1}{2}$. The middle triplet-level that corresponds to this value of $\cos \theta$ thus in a certain sense tends towards *the crossed position* $\cos \theta = 0$ of both components, but cannot, by the quantum conditions, quite reach it. The two outer triplet-levels $\cos \theta = \pm 1$ denote *parallel orientation in a similar or opposite sense*. When an external magnetic field is imposed the orbit of the outer valency electron adjusts itself in exact accordance with it, as prescribed by the quantum theory, whereas the inner complex displays the same behaviour only as the field gradually becomes stronger. If we add to this what was said above about the pictorial significance of the simple terms, we may assert that also in the case of the atoms, which generate triplet lines, the objects of the theory of atomic models are fully realised.

With regard to the more precise foundation of our argument and concerning certain difficulties that still subsist in the case of triplet atoms, for example, with respect to the meaning of the inner atomic number, we refer the reader to the more detailed account by W. Heisenberg in the *Zeitschrift für Physik*, 1922.

CHAPTER VII

BAND SPECTRA *

§ 1. Historical and Empirical Preliminaries. Uniform View of Deslandres and Balmer Terms.

THE first step towards ordering band spectra and describing them by formulae was taken by Deslandres. The formulae which he obtained from consideration of a great number of empirical data became the model of all later developments in a way similar to that in which Balmer's formula became the archetype of all series representations. Schwarzschild created the foundation for the theoretical interpretation of Deslandres formulae in the light of the quantum theory and Bohr's models in the same work (cf. p. 276) in which he also treated the Stark effect. He there started from the idea proposed by N. Bjerrum † for the infra-red absorption spectra, according to which the various lines of the band correspond to various rotational states of the absorbing gas molecules. We are indebted to Heurlinger ‡ for testing and deepening Schwarzschild's theory by considering the empirical data. But his results received general notice only when Lenz § set down the same results, in part independently of Heurlinger and in part going beyond him, from comprehensive theoretical points of view.

Owing to the complexity and confusion of the data of observation it is not easy to get a provisional survey of the empirical facts. We must, therefore, restrict ourselves to a few remarks concerning the nomenclature chiefly and we shall reserve the outstanding results of experiment till later, when we deal with their theoretical interpretation.

Expressed generally, band spectra are characterised by the close sequence of their lines and by the accumulation of the latter at the so-called *edges* or *heads* of the bands. The name "**band spectra**" is due to the fact that when the dispersion of the resolving apparatus is small they give the impression of continuously tinted bands. The bands are shaded off some at the red end and some at the violet end, that is some have edges on the

* Mr. Kratzer very kindly co-operated in the account given in this chapter.

† *Nernst-Festschrift*, 1912, p. 90.

‡ T. Heurlinger, *Untersuchungen über die Struktur der Bandenspektren*. Dissertation Lund, 1918, and also *Arkiv. för Matematik. Astron. och Fysik*, **12** (1916); *Physikal. Zeitschr.*, **20**, 188 (1919); *Zeitschr. f. wissenschaftl. Photographie*, **18**, 241 (1919).

§ W. Lenz, *Verh. d. D. Phys. Ges.*, **31**, 632 (1919).

red side and others on the violet side (cf. in this connexion the beginning of § 2 in Chap. IV.).

Band lines that seem to start out from the same edge are regarded as belonging together to one or more *partial bands* (single bands). The fact that such partial bands mutually overlap increases the difficulty of ordering and interpreting the band-spectra. The edges of the bands recur in more or less regular sequence. Among the totality of edges of the bands there may be distinguished, at least in the clearer cases, several *groups of bands*. Thus each group unites a series of heads of bands to a higher single form. Fig. 106 on page 429 exhibits such a group with five heads of bands and partial bands that start out from them towards the violet and overlap mutually. The various groups of bands, too, follow in regular sequence and form a *system of bands*. The complete band emission of a carrying agent consists not of one but in general of several band systems. It was already emphasised on page 202 that the carrier of band spectra is not the atom but the *molecule*.

But the appearance of the bands is by no means always such as here described. There are types of band spectra that have hitherto resisted all attempts to find order in their structure and that do not allow themselves to be arranged into groups and systems. To these there belong, among others, the so-called *many-lines spectra* (cf. § 5). The bands that lie in the infra-red are distinguished by their particular simplicity; in their case a single band is observed alone and the overlapping of groups of bands does not occur. We shall, therefore, deal principally (§ 2) with these spectra.

Our first concern is to arrive theoretically at the ground-element of band-emission, Deslandres' term, and to bring it into relationship with the ground-element of series-emission, Balmer's term.

We start from the Bjerrum-Schwarzschild idea of the rotator, but in doing so we do not think, as on page 198, of each individual point-mass rotating at a fixed distance from a centre, but more generally, of a rigid body rotating about a principal axis which we may regard as representing a molecule schematically. Let its moment of inertia about the principal axis be J , its angular velocity ω or ϕ . Then the moment of momentum and kinetic energy are, respectively, as we know,

$$\mathbf{M} = J\omega, \quad E_{kin} = \frac{J\omega^2}{2} = \frac{(J\omega)^2}{2J}.$$

Since the angle of rotation ϕ is a cyclical co-ordinate of the motion, the quantum condition for this rotator is, analogously to eqn. (18) on page 199,

$$2\pi\mathbf{M} = mh \quad (m \text{ is an integer}).$$

From this it follows that

$$J\omega = \frac{mh}{2\pi}, \quad E_{kin} = \frac{h^2}{8\pi^2 J} m^2 \quad (1)$$

We now distinguish between two cases :

I. The moment of inertia has a principal component J_0 , independent of the rotation and is only unappreciably affected by the rotation (Example : the earth and its flattening).

II. The moment of inertia is produced by the rotation itself and vanishes when the rotation vanishes (Example : a centrifugal governor, or Bohr's model of the hydrogen atom).

In Case I we have for the m th quantum state

$$J = J_0 + \Delta J_m \quad (\Delta J_m \text{ much less than } J_0) \quad . \quad . \quad (2)$$

In Case II we get in particular for the hydrogen model

$$J_m = \mu a_m^2 = \mu a_1^2 m^4 \quad . \quad . \quad . \quad (3)$$

where μ is the electronic mass, a_m and a_1 the radius of the m th and the 1st Bohr circle.

If we insert the values (2) and (3) in (1), we get in Case I a value for the energy that is approximately (i.e. neglecting ΔJ_m) proportional to m^2 :

$$E_{kin} = \frac{h^2}{8\pi^2 J} m^2 ;$$

whereas in Case II the m^2 of the numerator cancels with the denominator and we get a result that is proportional to $1/m^2$:

$$E_{kin} = \frac{h^2}{8\pi^2 \mu a_1^2} \frac{1}{m^2}.$$

By dividing by h we get from the energy to the " term," that is, to the contribution which the energy-step in question makes to a possible spectral emission of our rotator. In this way we get in Case I the *Deslandres' term*

$$Bm^2B, = \frac{h}{8\pi^2 J} \quad . \quad . \quad . \quad (4)$$

and in Case II the Balmer term

$$\frac{R}{m^2}, \quad R = \frac{h}{8\pi^2 \mu a_1^2} = \frac{2\pi^2 \mu e^4}{h^3} \quad . \quad . \quad . \quad (5)$$

The equality of the two values given in (5) for the Rydberg frequency actually follows from the following value for a_1 (cf. p. 212) :

$$a_1 = \frac{h^2}{4\pi^2 \mu e^2}.$$

Concerning the Balmer term we have yet to add that in the above we have taken account only of the *kinetic* energy of the rotator ; if we now add the potential energy, only the sign of the term becomes changed (cf. Note 5).

Accordingly we may regard the Deslandres' term as just as fundamental as Balmer's, the former for systems *with* an initial moment of inertia (molecules) the latter for systems *without* a moment of inertia originally (atoms).

§ 2. The Infra-Red Absorption Bands. Rotation and Rotation-Vibration Spectra

Suppose the rigid system considered in the preceding section to be a *diatomic molecule*, for example, I_2 , HCl , N_2 , and so forth. Let it consist of two nuclear points surrounded by electronic systems that are negligible as regards distribution of mass. The line which connects the nuclei is a principal axis of the system ("axis of figure"), and so is, indeed, every axis perpendicular to the latter ("equatorial axis"). It was an axis of the latter type that we meant when we spoke in the previous section about rotations about a principal axis of the rigid system. The moment of inertia J refers to it. On the other hand the axis of figure has a moment of inertia that is practically zero; rotations about this axis do not come into consideration as regards quanta (cf. § 6).

When we called the system rigid this was only implied in an approximate sense. The nuclei have, indeed, a position of equilibrium, under the influence of their mutual repulsions and the electronic attractions, but can move out of it if disturbances of equilibrium, collisions or energy-absorption or -emission occur. They then execute vibrations about the position of equilibrium. We assume that these "nuclear vibrations" occur *in the direction of the axis of figure*. In this sense every molecule represents not only a *rotator* but also an *oscillator*. If the vibrations are infinitely small, we have a *harmonic* oscillator; let its frequency be ν_0 . If the vibrations are regarded as finite, that is, if the nuclei move away from the immediate vicinity of their position of equilibrium to neighbouring parts of the field, then their mutual bond varies with the magnitude of the amplitude. The oscillator is then *non-harmonic* and, indeed, perceptibly so, because the true quantum state already entails rather considerable amplitudes and thus in no wise allows itself to be described as a harmonic vibration.

From the behaviour of the specific heats of gases we know that the rotational degrees of freedom (just as the translational degrees of freedom) are in full action at normal temperatures but that the vibrational degrees of freedom do not make themselves observed in the specific heat in the case of the simpler gases such as N_2 , O_2 , HCl , and so forth. From this we conclude that the rotational component of the motion is always present and, indeed, to a considerable degree, whereas the component of oscillation is often not excited and, when it is, only occurs in the process of rotation.

For the present we assume our oscillator to be harmonic. Furthermore, we here make the general observation that the important point for spectral questions is not the presence of an oscillation but rather the change in the state of oscillation, and not the presence of a rotation, but rather the change in the state of rotation. In the theoretical treatment we take the standpoint of the *process of emission*. The application of

this to the *process of absorption* which chiefly comes under observation is directly evident.

Let m' be any arbitrary rotational quantum-number, and m one that is fixed. Let m' characterise the initial state and m the final state of the rotation in the process of emission. If for the present we take into account only the energy of rotation, that is, if we assume that any oscillation that may be present at the same time does not alter its state then we should get from Bohr's hypothesis ($h\nu =$ energy difference) and from the calculation of the Deslandres' term, eqn. (4) of the preceding section :

$$\nu = B(m'^2 - m^2) \quad . \quad . \quad . \quad . \quad . \quad (1)$$

We call the wave-numbers thus represented a pure *rotation spectrum*.

We shall assume with Schwarzschild more generally that the change of the rotational energy is connected with a change of configuration of the molecule, whether this consists in a re-shuffling of the electrons, as Schwarzschild assumes in describing visible spectra, or whether it consists in a sudden change in the nuclear vibration, as we shall now assume for the purposes of the infra-red spectrum, or whether finally it is due to both phenomena simultaneously, as we shall have to assume later.

The nuclear vibrations, just like the rotations, are divided up into quanta. As we are calculating for the present with a harmonic oscillator, the nuclear vibrations are quantised according to energy elements $h\nu_0$. After what has just been said about the thermodynamic behaviour of gases, only the smallest values 0 or 1 come into consideration for the oscillation quantum n at normal temperatures, but any arbitrary values for the rotation quantum number m . Let n' be the quantum number of the initial oscillation, n that of the final oscillation. The change of energy then amounts to

$$h(n' - n)\nu_0$$

and the contribution of this energy-leap to the wave-number is

$$(n' - n)\nu_0.$$

Through the superposition of this contribution on the contribution (1) of the rotation we get

$$\nu = (n' - n)\nu_0 + B(m'^2 - m^2) \quad . \quad . \quad . \quad (2)$$

We call the sum total of the possible waves given in this expression a *rotation vibration spectrum*.

But the transition $m' \rightarrow m$ assumed by Schwarzschild (quantum leap of several units) contradicts the selection principle, not yet known in Schwarzschild's lifetime, according to which the jump in the rotational quantum number must be equal to ± 1 ; we shall later take into consideration the fact that under certain circumstances the quantum jump 0 must also be allowed. In the same way the transition $n' \rightarrow n$ in which the oscillation quantum number jumps by several units is contrary to the principle of correspondence, which in the case of the *harmonic*

oscillator likewise (cf. Note 10, d) only allows quantum jumps of one unit. Thus we set

$$m' = m \pm 1 \text{ and } n' = n \pm 1 \quad . \quad . \quad . \quad (3)$$

and get from (1), when $m' = m + 1$,

$$\nu = B(2m + 1) \quad . \quad . \quad . \quad (4)$$

and from (2) when $m' = m \pm 1$, $n' - n = + 1$

$$\nu = \nu_0 + B(\pm 2m + 1) \quad . \quad . \quad . \quad (5)$$

Concerning this we have to remark that in the rotation spectrum (4) the assumption $m' = m - 1$ would lead to negative wave-numbers; such belong to absorption processes and thus drop out here, where we have taken the point of view of emission. Consequently in (4) we had only to take into consideration the possibility $m' = m + 1$ for the jump in the rotational quantum-number. Likewise in the rotation-vibration spectrum (5) the assumption $n' - n = - 1$ would lead to negative wave-numbers. For we have to notice that in general the value of ν_0 predominates considerably over that of B . That is why the formula

$$\nu = \nu_0 + B(2m + 1) \quad . \quad . \quad . \quad (6)$$

which would result if we assumed $n' - n = - 1$, $m' = m + 1$, can never lead to a positive ν ; but the formula

$$\nu = \nu_0 + B(- 2m + 1),$$

contained in (5), which corresponds to the assumption $n' - n = + 1$, $m' = m - 1$, represents positive wave-numbers.

It is remarkable that as early as 1916 Bohr postulated in an essay* (which, however, appeared in print only in 1921) the restriction (3) for rotation quanta in just the case of infra-red band spectra supporting his argument on the general correspondence between classical and quantum radiation, this being a first suggestion of the correspondence principle which he later formulated.

What is common in the content of eqns. (4) and (5) is that they represent *equidistant sequences of lines* with the constant difference in wave-number

$$\Delta\nu = 2B = \frac{h}{4\pi^2 J} \quad . \quad . \quad . \quad (7)$$

In the rotation spectra (4) we have *one* such system, in the rotation-vibration spectra (5) *two* systems, according to the choice of the sign, a positive branch and a negative branch which, however, continue in one another beyond the "zero point" $m = 0$. As we shall see presently in Fig. 102, this zero point is not itself represented in the sequence of lines.

We have examples of both kinds of bands in the infra-red absorption spectra (which have also been observed by Paschen † as emission spectra).

* Appears in his *Gesammelte Abhandlungen* (Vieweg, Braunschweig, 1921), p. 138.
 † Ann. d. Phys., **53**, 336 (1894).

Pure rotation spectra have been observed in the case of water vapour by Rubens* and Fva von Bahr.† *Rotation-vibration spectra*, resolved into lines, were first observed in the case of HCl and H₂O by the same experimenters, and were recently measured with great precision by Sleator‡ in the case of water-vapour and by Imes§ in that of HF, HCl, HBr. The heteropolar nature of the molecules, that is, the circumstance that they are composed of one positive and one negative ion is essential|| for the occurrence of infra-red absorption. The rotation spectra lie in the more distant infra-red at 100 μ in round numbers (the latest measurements of Rubens extend as far as 132 μ), the rotation-vibration spectra lie in the nearer infra-red involving wave-lengths of several μ 's.

An interesting relationship, already anticipated by Bjerrum and proved by Eucken, exists between the rotation-spectra and the rotation-vibration spectra: the frequency-differences $\Delta\nu$ of successive lines are essentially equal in both spectra. By eqn. (7) this denotes theoretically that the moments of inertia of the molecules in both states do not essentially differ from one another.

The original interpretation of infra-red bands by Bjerrum, which was antecedent to Bohr's theory, was of course, different. Bjerrum did not quantise the moment of momentum, but the energy of the rotating molecule; moreover, he assumed the absorption frequencies to be equal to the mechanical frequencies, that is, he did not determine them from Bohr's frequency condition. He thus obtained from the frequency difference of neighbouring rotational states

$$\Delta\nu = \frac{h}{2\pi^2 J} \dots \dots \dots (8)$$

that is, twice our value (7). We have already met with this difference denoted by the factor 2 before, on page 199, where we compared the quantising of the rotator with that of the oscillator.

It would be possible to decide experimentally between formulæ (7) and (8) only if the moment of inertia J of the molecules were accurately known from another quarter, and this is not the case. Nevertheless, there can be no doubt nowadays that Bjerrum's view is to be given up in favour of Bohr's.

To pass on to the finer questions, such as, firstly, the *position of the null or zero-line* within the rotation-vibration bands we consider Fig. 102, due to Imes (*loc. cit.*) as well as the sketch, Fig. 103, that belongs to it. The gap in the sequence of the saw-edge immediately strikes us in Fig. 102. Not only is a tooth-edge missing here, but the *intensity* of the continuous

* Berliner Ber., 1913, p. 513.

† Verh. d. Deutsch. Phys. Ges., 15, 731 and 1150 (1913).

‡ Sleator, Astrophys. Journ., 48, 124 (1918).

§ Imes, *ibid.*, 50, 251 (1919).

|| Cf. W. Burmeister, Verh. d. Deutsch. Phys. Ges., 15, 589 (1913); Rubens and v. Wartenberg, *ibid.*, 13, 796 (1911).

background and the size of the tooth-edges clearly group themselves about this gap. We take this to mean the following: under all circumstances the frequency with which the various states of rotation occur depends on the quantum number m according to some law of distribution, and likewise under all circumstances the intensity of the absorption lines is proportional to the frequency of occurrence of the initial state in question. Equal intervals in the spectrum to the right and left of the null-line correspond say to equal values of m and accordingly exhibit absorption lines of approximately equal intensity. The course of the intensity here agrees well with the Maxwell-Boltzmann law of distribution, which, as in the classical theory of gases, we should expect first of all. The dependence of the intensity on the temperature (displacement of the two maxima of intensity outwards in proportion to the root of the absorbed temperature, a relation that emerges directly out of the work of Paschen (*loc. cit.*) agrees, so it seems, fully with this law.

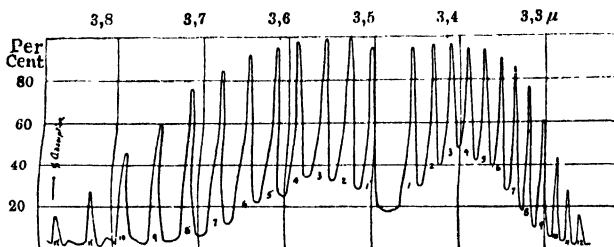

FIG. 102.—Rotation vibration spectrum of HCl, photographed by Imes by means of a reflexion grating of great dispersive power. The absorption per cent is plotted as the ordinate, and an angle of deflexion is plotted as the abscissa; the scale added above gives the corresponding wave-lengths in terms of μ . The middle of the band (see the gap in the row of teeth) corresponds to $\lambda = 3.46\mu$.

On account of their minimum of intensity in the middle the rotation vibration spectra, before they had been successfully resolved, used to be called "double bands" in contradistinction to the simple bands of the rotation-spectra, which exhibit no such gap.

According to (5) the position of the zero-point is given by

$$\nu = \nu_0 + B \quad . \quad . \quad . \quad . \quad . \quad (9)$$

It does not thus coincide with the position of the nuclear vibration ν_0 , but differs from it by B , that is, by half the distance between two teeth, $\Delta\nu$ in eqn. (7). Consequently two dotted lines have been inserted in Fig. 103; the one corresponds to the zero position $m = 0$, the other to the nuclear vibration ν_0 . In accordance with eqn. (9) the latter bisects the distance between the lines $1 \rightarrow 0$ and $0 \rightarrow 1$.

Now, what does the omission of the zero-line signify theoretically? It is a little easier to give the answer from the point of view of absorption than from that of emission. Thus we now take m (the final state in emission) as standing for the *initial state* in absorption. The dropping out of

the zero-line in absorption means that the transition $0 \rightarrow 1$ does not occur. From this we conclude that *the unexcited molecule is in the rotationless state $m = 0$ either not at all, or rarely, or only for a very short time.* This deduction is surprising at first sight and is excellently confirmed by the behaviour of the specific heat of rotation in the case of water according to calculations of Reiche* and Bohr.† We remark on the other hand that the reversed process of absorption $1 \rightarrow 0$, which corresponds in Fig. 102, to the first tooth-edge, marked 1, of the positive branch, is by no means forbidden, that is, that the rotationless state is certainly possible as the *final state of absorption.* This seems quite compatible with the assumed instability of the state $m = 0$.

According to Kirchhoffs' law we must assume for the process of emission, if it is excited as temperature radiation, that in its case likewise, the zero line drops out. But now, this signifies that the transition $1 \rightarrow 0$ does not occur, that is, that the rotationless state $m = 0$ is not the *final state*

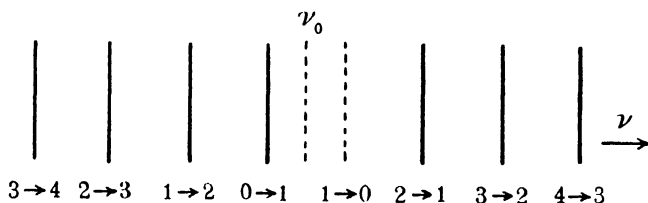

FIG. 103.

aimed at by emission. This is difficult to picture physically, the more so as in the case of absorption the state $m = 0$ is certainly possible, as one remarked, as the *final state.* It is equally difficult to understand that the emissive process $0 \rightarrow 1$ is certainly not, according to Kirchhoff's law and according to observation in the case of absorption spectra, forbidden, that is that the rotationless state, in spite of its assumed instability must be possible as *the initial state of the emission.* A direct observation of infra-red emission spectra, in particular in the neighbourhood of the zero-line would accordingly, in view of the confidence that we must repose in Kirchhoff's law, be highly desirable.

Earlier, in considering the *atom*, in particular in interpreting the Zeeman and the Stark effects (cf. p. 282), we excluded the orbits of vanishingly small azimuthal quantum-number, that correspond in a certain sense to the rotationless state $m = 0$ of the molecule, as being unreal, by means of a supplementary condition of selection. But in that case the position was much simpler than at present. The state $m = 0$ occurred neither as an initial nor as a final state, and could thus be regarded straightway as forbidden, whereas now the decree forbidding this state is only conditional and apparently different for emission and absorption.

* Ann. d. Phys., 58, 682 (1919). *

† On page 148 of the essay quoted on page 418.

We revert to the selective conditions (3), including both those for the rotation quantum as well as those for the oscillation quantum in Note 10, and consider them from the point of view of the principle of correspondence. This principle in itself asserts nothing about the rotationless state $m = 0$. But if we adduce the observed fact that the nuclear frequency $\nu = \nu_0$, dotted in Fig. 103, does not belong to the system of band-lines, it likewise allows us to infer that the rotationless state is improbable.

The equality of the distances between successive lines of the band, asserted in equ. (7) is very imperfect, as may be seen directly in Fig. 102; actually, a *definite retrogression*, namely, a decrease of the distance $\Delta\nu$ between the teeth towards the side of short waves, is clearly shown. According to Kratzer,* the explanation is as follows: whereas hitherto we have simply superposed rotation and oscillation on each other, a *mutual action*, between both actually occurs. There are two causes for this: on account of the oscillation the moment of inertia J of the molecule is no longer constant but variable. Its mean value is different from its original value J when there was no oscillation. In consequence of the rotation, on the other hand, the position of equilibrium of the nuclei, and hence also—in the case of a non-harmonic oscillator—the strength of the bond is changed.

In the formula (11) that follows the member due to the mutual action is represented by $-m^2 a_n \hbar$. To a first approximation the coefficient a_n is proportional to the oscillation quantum n , and contains, for the rest, the molecular constants (moment of inertia, the law of force between the nuclei). Thus to a first approximation the member due to the mutual action is proportional to the square of the rotation quantum and to the first power of the oscillation quantum. In the harmonic case, too, the coefficient a_n does not vanish (on account of the first of the two above-mentioned causes of the mutual action); here it carries a negative sign. Increasingly non-harmonic connection between the nuclei gradually makes the sign of a_n positive.

Let W_m^n denote the energy of the molecule that is associated with the rotation quantum m and the oscillation quantum n , and W_0^n correspondingly the energy of the rotationless molecule for the oscillation quantum n , for which we set $n\hbar\nu_0$ in the harmonic case. In the non-harmonic case there stands in place of this a development of the form

$$W_0^n = n\hbar\nu_0(1 - xn + \dots) \quad (10)$$

which advances in powers of xn ; the little constant x depends on the law governing the non-harmonic connexion.

On the other hand, the formula for W_m^n is:

$$W_m^n = W_0^n - m^2 a_n \hbar + \frac{\hbar^2}{8\pi^2 J} (m^2 - \dots) \quad (11)$$

* A. Kratzer, Zeitschrift f. Phys., 3, 289 (1920).

The last term is the rotational energy, and corresponds to the Deslandres' term. The brackets denote that when we take into consideration the centrifugal effects a supplementary member involving m^4 becomes added to m^2 , and apparently changes the moment of inertia J [cf. § 1, eqn. (2), where the corresponding change was denoted by ΔJ_m]. The formulæ (10) and (11) are derived in Note 17.

Arguing from eqn. (11) we now find it easy to account for the gradual change in the distance between the tooth-edges of the absorption bands. It is to be noted that according to page 416 the initial value of n must be assumed equal to zero in the process of absorption, If, as before, we represent this same process as a process of emission, we have to insert in the former the final value 0 for n , and set the initial value equal to 1, 2, . . . But for the initial value $n = 0$ the first two terms in (11) drop out, not, however, for the initial value $n = 1, 2, . . .$ In the expression for the difference the first two terms due to the initial state remain standing, and furnish a member quadratic in m to the formula for the band. This explains the gradual change in question of the interval between the lines. From (11) we easily get for the distance between successive peaks :

$$\Delta\nu(1 + \dots) - (2m - 1)a_n \dots \dots \dots (12)$$

Thus the constant interval $\Delta\nu$ calculated in (7), on the one hand, becomes slightly altered by the centrifugal effects of the rotation, as was first shown experimentally by F. Eucken, and as is indicated by the brackets $(1 + \dots)$, and, on the other hand, and more markedly, it becomes *systematically reduced* as m increases owing to the mutual action between the oscillation and the rotation when a_n is positive (non-harmonic oscillator). It is just the latter that is shown in Fig. 102.

Whereas only jumps of the oscillation quantum by 1 were possible for the harmonic oscillator, eqn. (4), any arbitrary jumps > 1 are now admissible for the *non-harmonic oscillator* now under consideration, corresponding to its overtones. From this it follows that the first member on the right in eqn. (5) is generally to be replaced by

$$\nu_0(1 - x), \quad 2\nu_0(1 - 2x), \quad 3\nu_0(1 - 3x) \dots \dots \dots (13)$$

We infer this directly from eqn. (10) by assuming $n = 0$ for the final state of the process of emission (initial state of the absorption), and $n = 1, 2, 3 \dots$ for its final state. Two conclusions of a different kind may be drawn from (13). **1.** In addition to the "ground band" hitherto considered, which also occurs in the harmonic oscillator, there are "overtone bands" of approximately two, three times the wave-number of the middle of the band. **2.** These wave-numbers are not in the exact ratio $1 : 2 : 3 : \dots$, but are out of tune with one another according to the measure of the quantity x .

Mandersloot (Diss., Amsterdam, 1914) appears to have been the first

to meet with success in looking for such overtone-bands (in the case of CO). Then we have to mention Brinsmade and Kemble,* who established the presence of an overtone-band in measurements which they had carried out themselves. Hettner † gives a comprehensive résumé of their own and other measurements of infra-red bands that have partly been resolved into lines. The following numbers signify the observed wavelengths of the "centres of the bands" (that is, essentially, of the zero lines) in terms of μ :—

TABLE 46.

	ν_0	$2\nu_0$
HCl	3.46	1.76
HBr	3.91	1.98
CO	4.67	2.35

In the case of H₂O Hettner derived from the frequencies ν_1, ν_2 of two ground-bands no less than 12 overtone bands and combination-bands approximately of the form :

$$s_1\nu_1 + s_2\nu_2.$$

According to Kratzer, *loc. cit.*, the second and third overtone-bands may be recognised besides the first in observations of HCN noted by Burmeister.

The band at $\lambda = 3.46\mu$ in the case of HCl quoted in Table 46 was shown in Fig. 102. The corresponding overtone-band $\lambda = 1.76\mu$, likewise measured by Innes, is added in Fig. 104. It exhibits not only the

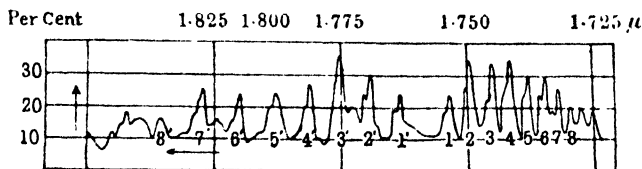

FIG. 104.

same $\Delta\nu$, but also, as Kratzer remarks, a double a_n (twice as rapid a change in the $\Delta\nu$), and by both of these circumstances proves itself to be attributable to the ground-band 3.46 as an overtone-band. But particular interest attaches to the subsidiary maxima that occur in this band. According to Loomis ‡ and Kratzer, § they are to be explained by the existence of the isotopes, Cl₃₅ and Cl₃₇. For since the nuclear vibration ν_0 depends

* J. B. Brinsmade and E. C. Kemble, Proc. Nat. Ac., **3**, 420 (1917).

† Hettner, Zeitschr. f. Phys., **1**, 351 (1920).

‡ F. W. Loomis, Astrophys. Journ., **52**, 248 (1920).

§ A. Kratzer, Zeitschr. f. Phys., **3**, 460 (1920).

on the mutual connexion and the masses of the vibrating nuclei, and since, in the case of two isotopes, the connexions are the same, and the masses are different, so we get two somewhat different ν_0 's for Cl_{35} and Cl_{37} , and hence two rotation-vibration bands that are a little displaced relatively. The subsidiary maxima denote the band of Cl_{37} , and are small compared with the principal maxima of the band Cl_{35} , corresponding to the relative amounts 1 : 3 of Cl_{37} and Cl_{35} (cf. p. 86).

The difference between the two nuclear vibrations is derived theoretically as follows :

If μ denotes, as on page 220, the "resulting" mass, that is

$$\frac{1}{\mu_{35}} = 1 + \frac{1}{35}, \quad \frac{1}{\mu_{37}} = 1 + \frac{1}{37}$$

then, by Note 17, this enters into the ordinary formula for calculating the characteristic frequencies

$$2 \nu_0 = \sqrt{\frac{f}{\mu}}$$

If we designate the relative distance between the vibration-frequencies of HCl_{35} and HCl_{37} by $\frac{\delta\nu}{\nu}$ and the relative difference of wave-lengths by

$\frac{d\lambda}{\lambda}$, we get

$$\frac{\delta\nu}{\nu} = \frac{1}{2} \delta \left(\frac{1}{\mu} \right) = \frac{1}{2} \left(\frac{1}{\mu_{35}} - \frac{1}{\mu_{37}} \right) = \frac{1}{2} \left(\frac{1}{35} - \frac{1}{37} \right) = \frac{1}{1295}$$

that is,

$$\delta\lambda = - \frac{\delta\nu}{\nu} \lambda = - \frac{1.76}{1295} 10^{-4} \text{ cms.} = - 13.54 \text{ \AA} \quad . \quad . \quad (14)$$

The negative sign denotes that the lines of Cl_{35} have the shorter wave-lengths, that is that superposed on their *long-wave side* they have the small tooth-edges corresponding to Cl_{37} ; cf. Fig. 104. The value of $\delta\lambda$ in (14) likewise agrees with experiment; according to Imes, its experimental value is $14 \pm 1 \text{ \AA}$. We referred earlier, on page 86, to this beautiful confirmation of Aston's observations on isotopes.

§ 3. Visible Bands. Meaning of the Head of the Band

To carry our considerations over into the visible region, we have to add to the two partial phenomena of rotation and oscillation as a third phenomenon a change in the structure of the atoms or ions constituting the molecules. The simultaneous occurrence of these three partial phenomena is postulated, at least for a homœopolar molecule like N_2 by the principle of correspondence (cf. Note 10 d).

We are thus now dealing in a certain sense in the initial and the final state with two different molecules, that differ by just the required

change of configuration of their constituents. The result of this is that all constants that depend on the details of the molecular structure, in particular the moment of inertia J and the ground frequency ν_0 of the nuclear vibration, become different in the initial and final state. We designate them (in analogy with m' , m , and n' , n on p. 417) by J' , J , ν'_0 , ν , and so forth.

We first consider the rotational constituent, so as to be able to understand afterwards the structure of a partial band in the visible region. We thus form the difference of the Deslandres' term, eqn. (4) in § 1 for the initial state ($m' = m \pm 1, J'$) and for the final state (m, J):

$$\frac{hm'^2}{8\pi^2J'} - \frac{hm^2}{8\pi^2J} = \frac{hm^2}{8\pi^2} \left(\frac{1}{J'} - \frac{1}{J} \right) \pm \frac{hm}{4\pi^2J'} + \frac{h}{8\pi^2J} \quad (1)$$

and, owing to the frequency jump and the changes of configuration in the electronic structure, we also add the member $\nu_k + \nu_e$; the indices k and e refer to the nuclei and the electrons; ν_k takes the place of the nuclear vibration that we designated by ν_0 under the simpler conditions of the preceding paragraph. In this way we get the general band formula

$$\nu = A \pm 2Bm + Cm^2 \quad (2)$$

The constants A, B, C , have the following meaning (cf. also eqn. (4) in § 1):

$$A = \nu_k + \nu_e + \frac{h}{8\pi^2J'}, \quad B = \frac{h}{8\pi^2J}, \quad C = \frac{h}{8\pi^2} \left(\frac{1}{J'} - \frac{1}{J} \right) \quad (3)$$

In Fig. 105 we have drawn the parabola $\nu = A + 2Bm + Cm^2$ contained in eqn. (2); m is plotted as the ordinate, and ν as the abscissa. This type of graphical representation is probably to be credited to Fortrat.* The parabola has been drawn as a continuous curve as far as the axis of the abscissa, $m = 0$, and thence onwards it is dotted. That arc of the parabola $\nu = A - 2Bm + Cm^2$ (that is, the bottom sign in eqn. (2)), which corresponds to positive ordinates m has also been drawn continuously, the other part being dotted. Both parabolas are cut by the system of horizontal straight lines of which the ordinates m are integers, and the points of intersection have been projected perpendicularly on to the axis of the abscissæ. This gives rise in the lower strip of the figure to the observable arrangement of the band-lines ν and their characteristic accumulation at the *head of the band*. The one part of the lines corresponds to the arc of the parabola with a positive sign for B , and is to be called the *positive branch*, the other owes its origin to the parabolic arc with the negative sign and is called the *negative branch*.

From this figure we may get a splendid survey of *the position of the head of the band* in the system of the band-lines. The analytical con-

* R. Fortrat, Thèse (Paris, 1914), p. 109.

dition for the position of the head of the band is, according to (2) (if we treat m for the time being as a continuous variable) :

$$\frac{1}{2} \frac{dv}{dm} = 0 = \pm B + Cm \quad . \quad . \quad . \quad (4)$$

$m = \frac{|B|}{C}$ or, respectively, the nearest integer.

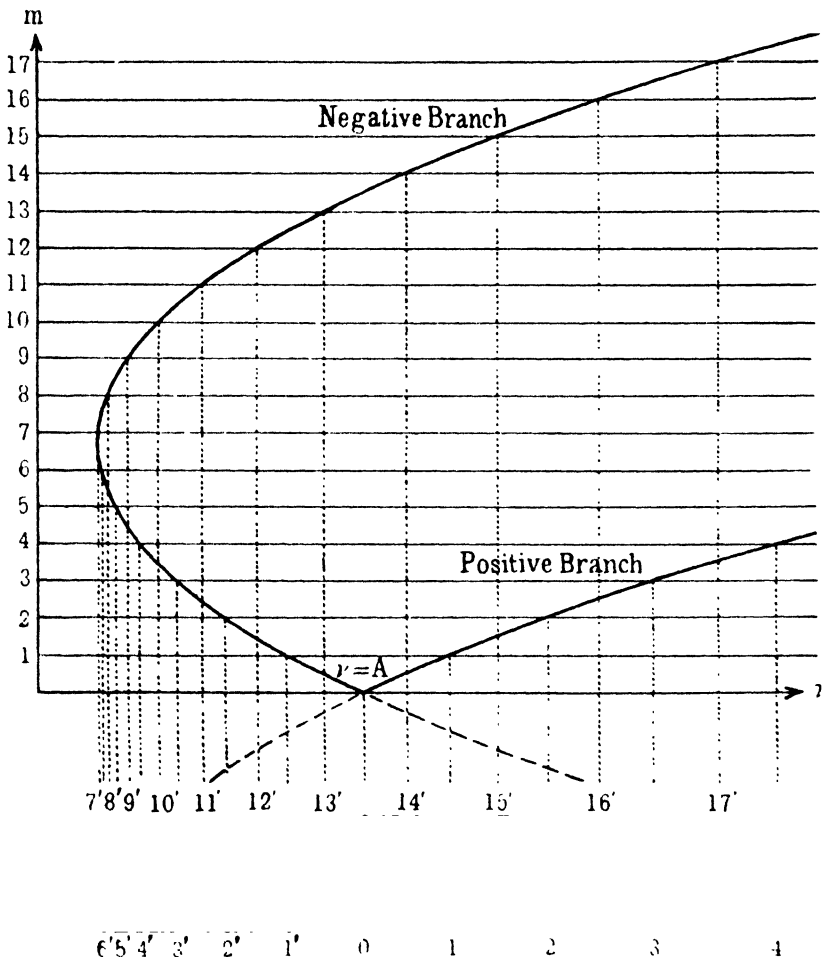

FIG. 105.

The head of the band is not, like the edge of a line series, a natural point of accumulation, but in a certain sense an *accidental* one. The lines do not crowd together infinitely densely, but only to a finite maximum of density. The circumstance that the lines of the band partly tend towards the head of the band and partly tend away from it, apparently disturbs the regularity of the course of the lines. But the regularity becomes

perfect if, as in Fig. 105, we imagine the two-dimensional parabolic law of (m, ν) to be taken in conjunction with the one-dimensional scale of the ν 's. We are indebted to J. N. Thiele* for having given the explanation of this view of the band-head as being a *somewhat accidental accumulation of lines conditioned by the scale of the ν 's*.

To be able to draw inferences concerning the properties of the emitting molecule from the representation of bands given in (2), it is essential that the number m giving the position of the band-lines be correctly counted. If we displace the zero-point of the enumeration, we thereby alter the significance of the constants A and B in (3). The position number n may not, as in the case of Deslandres, be counted from the head of the band; rather, in approaching the head and then moving away from it, it advances continuously, corresponding to the circumstance that the head of the band denotes no real singularity of the band law.

To arrive at a natural method of counting m and at a correct choice of the zero-line ($m = 0$) when a partial band is empirically given, we revert to Fig. 102 for the infra-red bands. Here the immediately evident saddle-shaped hollow in the course of the intensity curve formed the boundary between the positive and the negative branch and served as the zero-line of the enumeration. In the case of the visible bands, too, an analogous cut in the distribution of intensity may be proved to occur; it, likewise, has to serve to define the zero-line. The *intensity zero* is then to be ascribed to this line itself. On both sides of it the intensity of the band lines first increases, then decreases, likewise in agreement with Fig. 102 and with the explanation there given according to the Maxwell-Boltzmann law. In the scale of the m 's the intensity is symmetrical on each side of the zero-line and is equal for corresponding points on the positive and negative branches. But in the scale of the ν 's the symmetry of the course of the intensity becomes unrecognisable on account of the folding back and the distortion of scale caused by projection. In Fig. 105 the thickness of the strokes in the strip at the bottom denotes the increase and decrease of the intensity of the lines both in the positive branch (to the right of the zero-line) as well as in the negative branch (from the zero-line to the head of the band and beyond it). The fact that in our diagrammatic representation as well as in many real cases one of the two maxima of intensity happens to lie near the head of the band produces the result that the latter often appears to be brought out as a strong fluting in the spectrum as a whole. This circumstance is, however, essentially accidental and depends, moreover, on the temperature. To this it is to be further remarked that in the case of infra-red band spectra the symmetry seems only to be slightly disturbed in the scale of the ν 's, too (Fig. 102).

The *criterion of intensity* for the position of the zero line which is here developed is due to Heurlinger (*loc. cit.*). Another criterion was set up

* Astrophys. Journ., 6, 65, 1897; Kopenhagener Akad., 1899, p. 143.

by Fortrat (*loc. cit.*) a little earlier. In the regular progress of the band-lines disturbances sometimes occur, abnormalities of frequency, and indeed, they occur in *pairs*. Fortrat suggests that the zero-point of the enumeration be placed in the middle of the abnormal pair, that is, so that opposite order-numbers $\pm m$ (more exactly $+m$, and $-m-1$) become allocated to the disturbed lines. Heurlinger then succeeded in showing that this criterion suggested by Fortrat is practically identical with his own criterion of intensity. The theoretical significance of the disturbances hereby indeed remains unexplained (just like the corresponding occurrences in the series spectra) but is of no account for the practical application of the criterion.

The classical instance of the theory of bands is furnished by the so-called cyanogen bands. We follow Runge and Grotrian* in ascribing them, contrary to their name, to the N_2 -molecule. Their lines consist of very narrow doublets, separated only for higher values of m . Their

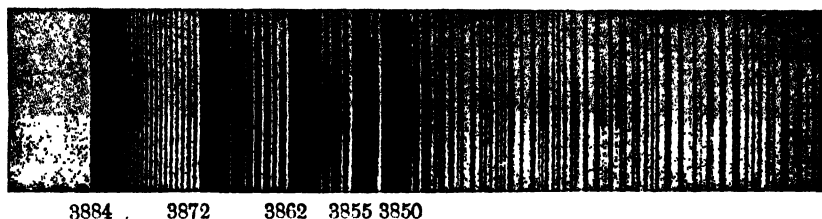

FIG. 106.

The cyanogen band $\lambda = 3884$ out of the carbon arc. At the edges the lines that are no longer resolved, appear as continuous black strips. Taken in the second order of a large concave grating.

centres of gravity follow the band law (2) considerably closely. Heurlinger has subjected them to a new exact treatment and partial re-measurement. In several of these bands there are several hundred lines. For example, in a partial band of the group $\lambda = 4216$ the lines from $m = -77$ to $m = -15$ and $m = -30$ are all present with the exception of $m = 0$, even if they are of course not separable in the vicinity of the head of the band (between $m = -15$ and $m = -30$ for the partial band just quoted); the whole complex of lines is arranged in regular sequence.

Our Fig. 106 represents the group of five band heads already mentioned on page 414. The one which has the longest wave-length among them has the wave-length $\lambda = 3884$. The second head lies at $\lambda = 3872$, the third at $\lambda = 3862$, and so forth. The partial band belonging to each head is subdivided into a positive and a negative branch. Heurlinger has determined the zero-lines for each of the three heads mentioned and has

* *Physikal Zeitschrift*, 15, 545 (1914).

worked out the constants of formula (2). For example, he finds for the first of them, $\lambda = 3884$:

$$2B = 3.84 \text{ cm.}^{-1}, \quad C = 6.8 \cdot 10^{-2} \text{ cm.}^{-1}$$

that is, he gets an essentially smaller value for C than for B. According to our eqn. (3) this was to be expected. For B is proportional to $\frac{1}{J'}$, whereas C is proportional to

$$\frac{1}{J' - J'}$$

that is, a quantity *small compared with* B since it is the difference between two quantities that presumably differ only slightly. Exactly similar conditions concerning the values of B and C also follow from the remaining partial bands of Fig. 106. We shall revert to the numerical relationships between the constants of the various partial bands in § 4.

A further test is furnished by the absolute value of B. To be able to compare it with our theoretical formula (3) we have to bear in mind that Heurlinger calculates in wave-numbers (cm.^{-1}) whereas the theory uses frequencies (sec.^{-1}). To reduce the former to the latter we have to multiply by $c = 3 \cdot 10^{10}$, and so have also to replace B by cB . On this basis we then calculate by (3):

$$J' - \frac{h}{8\pi^2 c B} = \frac{6.54 \cdot 10^{-27}}{12\pi^2 \cdot 3.84 \cdot 10^{10}} = 1.44 \cdot 10^{-39} \text{ gm. cm}^2. \quad (5)$$

If we set this equal to $2.14 \cdot m_{\text{N}} \cdot l^2$, where l denotes half the distance between the two nitrogen molecules, and $14m_{\text{N}}$ denotes the mass of the individual nitrogen atom, we get

$$l^2 = \frac{1.44 \cdot 10^{-39}}{2.14 \cdot 1.65 \cdot 10^{-24}} = 0.32 \cdot 10^{-16}, \quad 2l = 1.13 \cdot 10^{-8} \text{ cms.}$$

We thus arrive quite unmistakably at the well-known order of molecular size.

W. Lenz* has recognised a brilliant confirmation of the theory of bands in photographs of the fluorescence of iodine taken by R. W. Wood† Wood illuminates iodine vapour at a low pressure by means of the Hg-line 5461 (ground-member of the sharp subsidiary series). The iodine molecules, in absorbing the corresponding energy quantum $h\nu$, is brought into an excited ("*angeregt*") state. This state is associated with a perfectly definite value of the rotation quantum m . The iodine molecule re-emits the energy that is taken up, passing from the excited state to one of less energy. But the principle of selection allows only the transitions $m \rightarrow m - 1$ and $m \rightarrow m + 1$ (when the oscillation quantum and

* Physikal. Zeitschr., **21**, 691 (1920).

† Phil. Mag., **35**, 236 (1918).

the electronic configuration change simultaneously). Hence the re-emission occurs as a doublet or, with due consideration to the circumstance that in the case of the non-harmonic oscillator, the oscillation quantum is capable of arbitrary jumps, it occurs in a *system of doublets scattered over the spectrum*. Wood has observed about twenty such doublets. Each of them proclaims, as Lenz points out, in a very attractive way the sovereignty of the principle of selection over the rotation quantum; each shows us the process of birth of a partial band by two of its members. If, however, during the moment of absorption and that of re-emission* we make the iodine molecules collide more frequently with each other (at higher pressure) or with foreign atoms (by adding inert gases), then other values of the rotation quantum are thereby produced. Each doublet then becomes multiplied to form a complete partial band: under these circumstances Wood's fluorescence photographs approach the ordinary band type.

Hitherto in describing the partial bands we have spoken only of a positive and a negative branch. In complicated cases a third branch becomes added, which we call the *zero branch*; Heurlinger calls it Q-series and the positive and negative branches R- and S-series.

We shall not here consider the circumstances that there are even cases in which more than three branches emerge from the same head.

The mutual relationship between the positive, the negative, and the zero branch may be described in general outline if in the principle of selection of the rotation quantum, equ. (3) on p. 418, we allow the transition $m \rightarrow m$ besides the transitions $m \pm 1 \rightarrow m$. In equ. (1) at the beginning of this section we have then to set $m' = m$ and we get in place of (2) and (3):

$$v = A + C m^2 \quad . \quad . \quad . \quad . \quad . \quad (2a)$$

$$A = v_k + v_c, \quad C = \frac{h}{8\pi^2} \left(\frac{1}{J'} - \frac{1}{J} \right) \quad . \quad . \quad . \quad . \quad (3a)$$

Equ. (2a) now again represents a parabola; in the diagram of Fig. 105 it would lie symmetrically to the axis of abscissæ; its own axis falls along the latter axis and is at the same time the zero line from which m is counted.

Fig. 107 is founded on the measurements by Grebe and Holtz† of water-vapour in the vicinity of the edge $\lambda = 3064\text{Å}$; it was sketched by Heurlinger and kindly placed at the disposal of the author. Between the positive and the negative branches we see the zero branch in an approximately symmetrical position relatively to the axis of abscissæ. Each of the branches has been placed in the middle of the doublets, which are here

* In this view of the phenomenon Lenz sees a possibility of estimating the "time of stay" of the I_2 -molecule in its excited state. (Cf. also p. 353, footnote 2.)

† Ann. d. Phys., 39, 1243 (1912); arranged in the manner here depicted in Heurlinger, Dissertation, Tab. III, p. xxx.

in part widely separated and of which the interpretation in terms of the model is as yet wrapt in obscurity. As we see, the general course of the curves and their images at any rate agrees *qualitatively* with theory. But quantitatively the following difficulty of combination exists. If, quite apart from the special formulæ (2) and (2a) we represent the

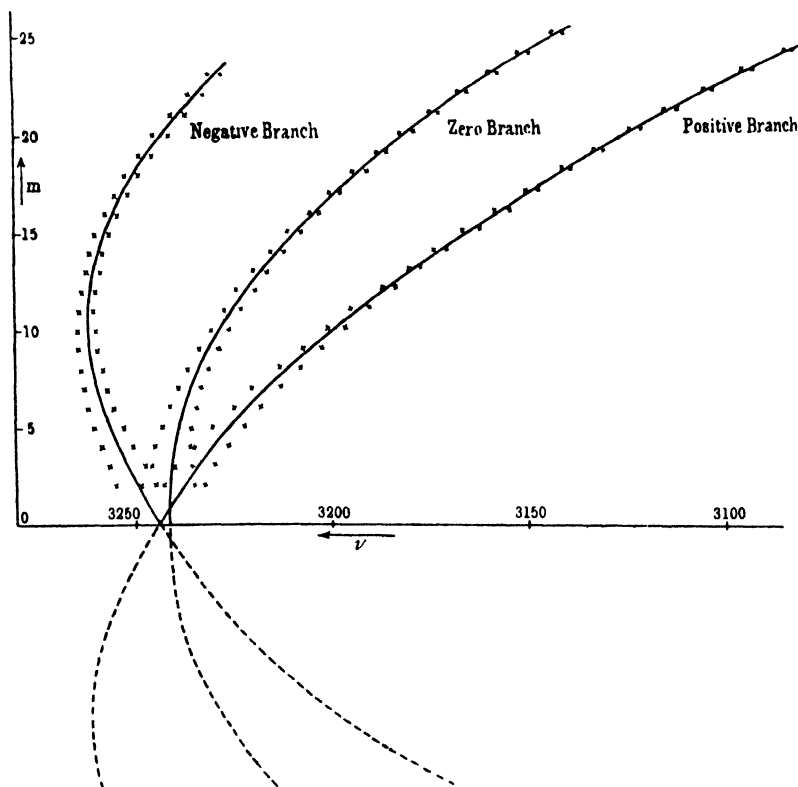

FIG. 107.

initial and the final state of the rotation by the general functions $f(m)$ and $g(m)$, we first get for our three branches:—

$$\begin{array}{lll} \text{Zero branch} & . & . \quad m \rightarrow m, \quad \nu = f(m) - g(m), \\ \text{Positive branch} & . & . \quad m + 1 \rightarrow m, \quad \nu = f(m + 1) - g(m), \\ \text{Negative branch} & . & . \quad m - 1 \rightarrow m, \quad \nu = f(m - 1) - g(m). \end{array}$$

If we now write down the zero branch twice, for m and for $m + 1$, and exchange $m + 1$ for m in the negative branch, we get the following three equations:—

$$\begin{array}{lll} \text{Zero branch} & . & . \quad \nu = f(m + 1) - g(m + 1) \} \\ \text{'' ''} & . & . \quad \nu = f(m) - g(m) \} \\ \text{Positive branch} & . & . \quad \nu = f(m + 1) - g(m) \} \\ \text{Negative branch} & . & . \quad \nu = f(m) - g(m + 1) \} \end{array}$$

Accordingly the bracketed sums of ν -values should be equal to one another. In reality they exhibit small systematic differences, "combination defects." Just as in the case of the Röntgen spectra (Chap. VIII, § 7) we must conclude from this that it is not the theory in general, nor the combination principle that is faulty, but rather that the allocation of the combined lines is not yet exactly correct.

§ 4. Law of the Edge of the Band. Band Systems.

Hitherto we have spoken only of the coefficients B and C of the band formula, which contain the influence of the rotations. To explain, further, the general arrangement of band systems we must deal with the coefficient A which contains the influence of the nuclear and electronic vibrations.

Firstly, our interest is directed at the "nuclear vibration" ν_k , which must be analysed according to eqn. (10), § 2; let the "electronic vibration" be summarised as before in the symbol ν_e and remain unanalysed. Thus we assume that the oscillation quantum of the nuclear vibration jumps from n' to n . In this jump the coefficients r_0 and x of eqn. (10) also change, say from r_0', x' to r_0, x . The application of Bohr's frequency condition (10) then gives us:

$$\nu_k = n' r_0' (1 - x' n') - n r_0 (1 - x n) \quad \left. \vphantom{\nu_k} \right\} \quad (1)$$

$$= (n' - n) r_0' + n (r_0' - r_0) - n' r_0' x' + n r_0 x$$

We have to insert this value of ν_k in the coefficient A, eqn. (3) of the previous section. According to the values of n and n' we thus get a double manifold of A-values which define the zero lines ($\nu = A$) of a doubly infinite system of partial bands, of the so-called "band system."

We now consider the second row of eqn. (1) in greater detail. Its individual members are arranged in order of magnitude. The first member is the principal one. It depends only on the quantum jump $n' - n$. The second member is small compared with the first as the change $r_0' - r_0$ is a small quantity and depends on the absolute value of the quantum-number n . The third member is in general still smaller as the coefficients x and x' are each small (cf. p. 422).

The principal member has different values for the quantum-jump 0 and the quantum-jump 1 (ground-vibration) or 2 ("first overtone"), and so forth. By keeping fixed the principal member, that is the quantum jump, and varying the value of n , we get a singly infinite series of partial bands, or zero-lines, respectively, that are more closely related together and are neighbours within the same band system; we call them a *band group*. The separate individuals of the band group differ in the second and third member of eqn. (1) and are numbered according to the value of n (or, what is the same of n').

Fig. 108 deals with the system of cyanogen bands. It exhibits four groups that correspond, from left to right, to the quantum jumps Δn

$= -2, 1, 0, +1$. The group $\Delta n = 0$ at $\lambda = 3884$ is already quite familiar to us from Fig. 106. It comprises five band heads for which n is, respectively, from left to right, equal to 0, 1, 2, 3, 4. Thus these five band heads successively correspond (on account of $\Delta n = 0$) to the quantum jumps

$$0 \rightarrow 0, \quad 1 \rightarrow 1, \quad 2 \rightarrow 2, \quad 3 \rightarrow 3, \quad 4 \rightarrow 4.$$

If we add to the right and left side of eqn. (1) the quantity $\nu_c + B$, then on the left we get, according to eqn. (3) of page 426, the quantity A , that is, the wave-number of one of the *null-lines* of our band system, namely:

$$A = \nu_c + B + n\nu_0'(1 - r'n') - n\nu_0(1 - rn) \quad (2)$$

In this equation we have already essentially deduced Deslandres' "Law of the Edges of Bands." Concerning its name we must remark that the

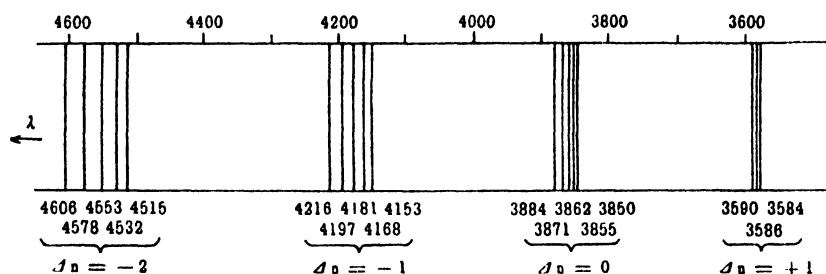

FIG. 108.

law does not exactly represent the position of the band heads, but that of the corresponding zero-lines, whose importance for the systematising of band-spectra had escaped Deslandres himself. The law is only approximately true for the band edges $\nu = \nu_K$ that are more or less close to the zero-lines $\nu = A$. Deslandres writes his law of band edges in the form

$$\nu_K = a'n' + b'n'^2 - (an + bn^2) + K \quad (2a)$$

It clearly coincides with (2) if we set

$$a = \nu_0, \quad b = -\nu_0 r, \quad a' = \nu_0', \quad b' = -\nu_0' r', \quad K = \nu_c + B.$$

Table 47* shows how exactly eqn. (2) gives the position of the zero-lines in the "cyanogen bands." In it the horizontal rows denote equal initial quanta, the vertical columns equal final quanta. Thus the diagonal row corresponds to the quantum jump $n \rightarrow n$ and represents the group $\Delta n = 0$ on Fig. 108; the parallels to the diagonal correspond, in the upward direction towards the right, to the groups $\Delta n = -1$, $\Delta n = -2$, and to the left downwards, to $\Delta n = +1$. The five constants a, b, a', b', K ,

* This table has been calculated by A. Kratzer: a provisional communication appears in *Physikal. Zeitschr.*, **22**, 552 (1921); it is given in greater detail in *Ann. d. Phys.*, 1922.

K of law (2) have been chosen so that the connexion with the measured zero-lines is perfect in particular in the first horizontal row of the table

TABLE 47

	$n = 0$	1	2	3	4	5	6
$n' = 0$	(3884) 25,797·83	(4216) 23,755·44	(4606) 21,739·54	—	—	—	—
	25,797·83	23,755·44	21,739·55	—	—	—	—
1	(3590) 27,921·3	(3872) 25,879·0	(4197) 23,863·0	(4578) 21,873·4	—	—	—
	27,921·38	25,878·99	23,863·10	21,873·71	—	—	—
2	—	(3586) 27,962·7	(3862) 25,945·5	(4181) 23,956·5	(4553) —	—	—
	—	27,962·04	25,946·15	23,956·76	21,993·87	—	—
3	—	—	(3584) —	(3855) —	(4168) —	(4532) —	—
	—	—	27,989·70	26,000·31	24,037·42	22,101·03	—
4	—	—	—	—	(3850) —	(4153) —	(4515) —
	—	—	—	—	26,040·47	24,104·08	22,194·19

1st line Wave-length of the edge.
 2nd „ Wave-length of the empirical zero-line.
 3rd „ Wave-length of the calculated zero-line.

where the empirical data are most exact. The deviation then remains very small in the other rows, too. At the lower end of the table the empirical determination of the zero-lines is wanting (instead of it only the edges are at our disposal); so that here comparison with theory cannot be carried out directly.

Whereas in Table 47 we considered the values A of the system of cyanogen bands, in Table 48 we set out the values of B and C of the same system, so far as they have been determined by Heurlinger (cf. p. 430). The arrangement is the same as in the preceding table. Thus, numbers

TABLE 48

	$n = 0$		1		2		3	
	2 B	100 C	2 B	100 C	2 B	100 C	2 B	100 C
$n' = 0$	3·84	6·8	3·83	8·5	3·85	10·1	—	—
1	3·88	4·5	3·81	6·4	3·80	8·2	3·82	9·7
2	—	—	3·80	4·1	3·88	5·6	3·78	7·6

that belong to the same group lie in an oblique column which goes from the top left corner to the bottom right corner. For example, the numbers that correspond to the group $\Delta n = 0$ of Fig. 108 are :

$$2 B = 3·84, 3·81, 3·88,$$

$$100 C = 6·8, 6·4, 5·6.$$

What was said on page 430 about the relative size of $B : C$ applies to all members of this and the remaining groups. But still more: the size of B is appreciably the same in the whole system, that of C varies much more. This, too, is intelligible from eqn. (3) on page 426, B is proportional to $1/J'$, so that it sensibly retains its value so long as the shape of the molecule does not alter appreciably. On the other hand C depends on the *difference* of the reciprocal moments of inertia, J' and J and is thus much more sensitive to changes of shape than B .

But the expressions (3) for B and C on page 426 are not exact enough. For, according to § 2, there has to be added to the *rotation* that was alone taken into account in (3), also *the mutual action between rotation and oscillation*. As may be gathered from the factor of n^2 in eqn. (11) on page 422, the latter is taken into consideration quite simply by replacing

$$\frac{h}{8\pi^2 J} \text{ by } \frac{h}{8\pi^2 J} - a_n.$$

We therefore now get instead of the value of B in eqn. (3) on page 426 the value expressed as a function of n' :

$$B(n') = \frac{h}{8\pi^2 J'} - a_{n'} = \frac{h}{8\pi^2 J'} - a' n' \quad . \quad . \quad . \quad (3)$$

Here the proportionality of a_n with n emphasised on page 422 receives expression and the new constant $a' = a_n/n$ is correspondingly introduced. If we correspondingly write

$$B(n) = \frac{h}{8\pi^2 J} - a_n = \frac{h}{8\pi^2 J} - a n \quad . \quad . \quad . \quad (3a)$$

with the further constant a , we get instead of C in eqn. (3) on page 426 more exactly

$$C(n, n') = B(n') - B(n) \quad . \quad . \quad . \quad (4)$$

Thus in B as well as in C we have to expect linear progress with n or n' respectively. This shows itself most clearly in Table 48 in the case of C (it is obscured by the inexactness of the last decimal in the case of the quantity B , which varies but slightly). For example, in the middle vertical column we have the numbers, depending on n' : 8.5, 6.4, 4.1; in the middle horizontal row, that is, depending on n we have: 4.5, 6.4, 8.2, 9.7. The fact that the one column decreases and the other (row) increases is in agreement with eqns. (4) and (3).

In eqn. (2) we wrote down the law for the zero-lines of a band system. We have only to combine this law with the law for the individual partial band, eqn. (2) of the preceding section, to get from it to the *complete law of lines for the whole band system*:

$$\nu = A(n, n') \pm 2B(n')m + C(n, n')m^2 + \dots \quad (5)$$

Let us again set out the significance of the coefficients according to eqns. (2) and (4):

$$\left. \begin{aligned} \Lambda(n, n') &= \nu_e + B(n') + n'\nu_0'(1 - n'x') - n\nu_0(1 - nx) + \dots \\ B(n') &= \frac{1}{8\pi^2J} - a'n', \quad B(n) = \frac{1}{8\pi^2J} - an \\ C(n, n') &= B(n') - B(n). \end{aligned} \right\} \quad (6)$$

Thus our law (5) contains three quantum numbers and nine disposable constants :

$$\nu_e, \nu_0, \nu_0', x, x', J, J', a, a'.$$

With their help we may in principle represent, for example, over 1000 lines in the system of cyanogen bands ; in the case of greater values of m we must indeed, to obtain numerical agreement, also take into consideration the higher powers of m , indicated in (5) by . . . (concerning, in the main, the change of the moment of inertia with the rotation ; cf. p. 423).

But we have still not finally achieved our object of setting up the general law of band systems (5). For one and the same molecule may possess several band systems, in that it is capable of several values of the electronic frequency ν_e ; these band systems, like the violet and red cyanogen bands may lie in quite distinct and separate regions of the spectrum. It will be surmised that the various values of ν_e will arrange themselves similarly to the various electronic jumps in line-series of the atoms, although we are here dealing not with atoms but with the complicated electronic systems of the molecules. We may well call band systems arranged together in series in this way "system-series." We have still to solve the problem, then, of extending the system law (5) to the "*law of system-series.*" We shall get to know examples of this at the end of the next section.

If it is true that two electronic jumps ν_e , that is, two transitions that give rise to two different band systems, have either the initial or the final state in common, then the representation of the common term obtained for the one band system may be applied to the other. Conversely, we may conclude from the fact that the violet and the red cyanogen bands have the same terms in the final state, as Heurlinger has shown, that here the molecular constitution and the chemical nature of the carrier must be the same. Furthermore, from the fact that the initial term of the red cyanogen bands also occurs in the first positive group of nitrogen as the final term, it is to be concluded that both the cyanogen bands and also the positive nitrogen group must have the same carrier, that is that they all belong to the nitrogen molecule or, according to circumstances, to one and the same nitrogen-compound, differing from N_2 .

From this example we see that the exact analysis of band systems will lead to illuminating disclosures about the molecular nature of their carriers.

§ 5. Many Lines Spectra.

The general character of the many lines spectrum of hydrogen has already been described on page 209, and has been illustrated by a figure

on page 210. Only the quantity but not the arrangement of the lines reminds us of the character of band-spectra. Band-heads are entirely wanting. The few partial bands that have hitherto been arranged together (cf. p. 209) are poor in lines; the two discovered by Fulcher comprise only five or six lines, the four discovered by Croze each about 12 lines. The sequence of lines in the partial bands is hereby so widely scattered that it is no longer evident that they belong together.

We shall show that this general character follows naturally from the smallness of the moment of inertia of the hydrogen molecule, and arranges itself as a limiting case into the general theory of band-spectra.

In eqn. (7), § 2, we obtained as the distance between neighbouring band-lines

$$\Delta\nu = 2B = \frac{h}{4\pi^2 I} \quad . \quad . \quad . \quad (1)$$

The same value also follows for lines near the zero-line from the general eqn. (2), § 3, if we neglect the quadratic member.

In the case of the cyanogen bands we had (cf. Table 48) $2B = \Delta\nu = 3.8 \text{ cm.}^{-1}$, corresponding to a value 0.6\AA for $\Delta\lambda$. In Fulcher's partial bands of the many lines spectrum, however, $\Delta\nu \cong 100\text{\AA}$, which corresponds at $\lambda = 6000\text{\AA}$ to the value $\Delta\nu \cong 280 \text{ cm.}^{-1}$. Thus in the many lines spectrum the line-interval $\Delta\nu$ is about 74 times as great as in the cyanogen bands. From this it follows by eqn. (1) that the moment of inertia of hydrogen is 74 times as small as that of the carrier of the cyanogen bands. Whereas we found in the former case

$$J = 1.44 \cdot 10^{-39} \text{ grm. cm.}^2, \quad 2l = 1.13 \cdot 10^{-8} \text{ cms.} \quad . \quad (2)$$

we now get

$$J = 1.9 \cdot 10^{-41} \text{ grm. cm.}^2, \quad 2l = 0.5 \cdot 10^{-8} \text{ cms.} \quad . \quad (3)$$

The moment of inertia of the hydrogen molecule found in this way need not be that of the normal state. In the normal unexcited state it is not the visible many lines spectrum, but (cf. p. 344) a band spectrum situated in the extreme ultra-violet that is emitted. This already follows from the fact that hydrogen gas is quite transparent in the visible region. Indeed, we must accept the idea that the H_2 -molecule is capable of very different states with perhaps other values for the moment of inertia, which give rise to other sequences of lines of the spectrum. The lines hitherto associated together form only a very small fraction of the sum-total of lines.

The value (3) of J is of importance for the question of the model of the H_2 -molecule. From Bohr's model on page 76 it follows that

$$J = 2.9 \cdot 10^{-41} \text{ grm. cm.}^2 \quad . \quad . \quad . \quad (4)$$

It is obvious that the moment of inertia cannot be greater in the unexcited state than in a possible excited state on which the value (3) is based.

Contrary to this, (4) is perceptibly greater than (3). Thus Bohr's model does not, at any rate, represent the normal state of the H_2 -molecule. We have here touched on one of the objections that were already raised against this model on page 78. On the other hand, the value $J \cong 2 \cdot 10^{-41}$ deduced by Reiche* from the behaviour of the specific heat agrees almost exactly with our value (3).

The small value of J explains immediately in the sense of eqn. (1) why the successive lines belonging to a partial band are so far apart in the many lines spectrum. But it also explains why there are only so few lines of observable intensity in each partial band.

Let us first call to mind the fact discovered by Nernst and Eucken that at very low temperatures (below 200° abs.) the rotation of the H_2 -molecule dies away more and more, and that hydrogen approaches more and more to the monatomic gases in its thermal behaviour. In general language the reason is to be found in Boltzmann's probability factor

$$e^{-\frac{E_{kin}}{kT}}$$

(k = Boltzmann's constant = the gas constant divided by Loschmidt's or Avogadro's number). If we here insert for the kinetic energy of the rotator its value out of eqn. (1), § 1, we get

$$e^{-\frac{h^2}{8\pi^2k} \cdot \frac{m^2}{JT}} \dots \dots \dots (5)$$

The decisive quantity is the product JT . The smaller it is, the less is the probability of a definite rotation quantum m . At very low temperatures all values † $m > 1$ become statistically suppressed; that is what Nernst and Eucken have shown. But even at moderate and higher temperatures the product JT is much smaller in the case of hydrogen, owing to its small J , than for other gases. For this reason greater values of m are statistically suppressed in the case of hydrogen at higher temperatures also.

Concerning the distribution of intensity in the band-spectra it follows from this that within a partial band of the many lines spectrum the intensity decreases much more quickly as m increases than, for example, in an N_2 -band. The ratio of the moment of inertia of N_2 to that of H_2 is, by eqns. (2) and (3), about equal to 100 : 1. Accordingly, by eqn. (5), the same temperature being assumed, the number of lines of observable intensity in an N_2 -band will be about ten times as great as in an H_2 -band. Whereas the cyanogen bands possessed partial bands of about 100 lines, the partial bands in the many lines spectrum of H_2 will consist of only 10 lines.

* Ann. d. Phys., 58, 682 (1919).

† $m = 0$ also drops out here. Cf. Reiche, *loc. cit.*, and Bohr, *Gesammelte Abhandl.*, p. 146.

This accounts for the particular character of hydrogen bands, namely, that they are sequences of small numbers of lines widely separated; in a certain sense they are *torsi* of normally developed bands. There can be no question under these circumstances of accumulations of these lines to form band-heads. If many such short sequences of lines are thrust within each other, we get the appearance of the many lines spectrum, a confusion of lines without flutings ("*Kannelierungen*") or regularities obvious to the eye.

The many lines spectrum of helium forms an instructive intermediary between the many lines spectrum of hydrogen and the ordinary band-spectra. It was discovered by Goldstein* (1913); Fowler has measured it out, but has only partly communicated his results.† When as in the case of the many lines spectrum of hydrogen the band character had entirely vanished, it is still recognisable in the spectrum just mentioned, but is far from being as pronounced as, for example, in the case of the cyanogen bands. The sequences of lines are partly head-less, and partly furnished with a band-head. The number of lines of the negative branch amount to 11 in the partial band measured by Fowler; the interval between the lines is of the order of magnitude $\Delta\nu = 30$ in the vicinity of the zero-line. From this, by eqn. (1), the moment of inertia

$$J = 1.7 \cdot 10^{-40}$$

would follow, that is a value ten times greater than for H_2 and ten times smaller than for N_2 . These numbers give expression to the intermediate position of our present spectrum as compared with the many lines spectrum of hydrogen on the one hand, and the true band spectra on the other.

But what are we to think of the "moment of inertia" of helium? The moment of inertia of the helium atom is practically equal to nothing; so that we can only be dealing with the moment of inertia of an "He-molecule" of transitory existence. We may picture its mode of origin more clearly as follows. Suppose two He-atoms are in an excited state such that one of each of the two He-electrons of each atom are slightly more distant from the nucleus than usual. Two such He-atoms resemble two hydrogen atoms, for they each consist of an outer electron and an atomic residue bearing a single positive charge. Thus they are able to enter into a bond similar to that of two hydrogen atoms, and may, therefore, combine to form an He_2 -molecule.

Hereby the excitation conditions for H and He are opposite. In the case of H the many lines spectrum arises more readily (at lower potentials) than the Balmer spectrum; in that of He, however, the many lines spectrum requires greater excitation than the ordinary series spectra. This seems quite compatible with the preceding view, according to which

* Verh. d. D. Phys. Ges., **15**, 402 (1913). Independently and a little later, Curtis, Proc. Roy. Soc., **89**, 146 (1914).

† *Ibid.*, **91**, 210 (1915).

a preliminary condition for the genesis of the "He-molecule" is a considerable loosening of the He-atoms.

The rule on page 202, according to which *band-spectra* are to be attributed to *molecules*, line-spectra to *atoms*, is here strikingly illustrated; the spectral character of the band-spectrum compels us, as it were, to assume the transitory existence of an He₂-molecule. As this is assumed only for the case of electric excitation, it by no means contradicts other chemical observations that have to do with unexcited molecules.

The many lines spectrum of He consists of numerous partial bands and exhibits many heads. To the eye they seem to arrange themselves into greater units, groups, and systems. But Fowler has gone a step further. He has succeeded in extracting from within these greater units such sequences as satisfy a quantitative series formula of the nature of Rydberg's, a formula in which Rydberg's number R actually occurs. Although nothing more exact with regard to measurement can be gathered from the matter at present published, yet we feel disposed to see in this an indication of the "system series," of which we spoke at the end of the preceding section. Thus we should be dealing with the energy-levels of the electronic configuration in the He₂-molecule and their quantum jumps; in our general formula of systems, (5) and (6) of the preceding section, they would receive expression in the member ν_r .

On the other hand our Fig. 66 on page 210 discloses a peculiar relationship between the many lines spectrum of hydrogen and the Balmer series. We are inclined to interpret this relationship in the same sense. Even if it is not necessarily apparent that the changes of configuration in the H₂-molecule follow the same laws quantitatively as in the case of the H-atom, yet a certain qualitative relationship between the molecular and the atomic configurations and hence also between the many lines spectrum and the Balmer spectrum is comprehensible. We can, of course, pass sound judgment on this point only when the analysis of the many lines spectrum of hydrogen has been carried much further than at present.

§ 6. Gyroscopic Motion of Molecules. Zeeman Effect of Band-Spectra.

The assumption hitherto made that the molecule rotates about a fixed axis is very special and admissible only when the axis of rotation coincides with a principal axis of the mass-distribution. The general motion of the molecule is not rotation but *gyroscopic motion*. We distinguish, as is known, between the symmetrical and the unsymmetrical top, according as the moment of inertia of the mass-distribution is an ellipsoid of revolution or a tri-axial ellipsoid. Diatomic molecules (H₂, HCl, etc.) represent symmetrical tops, tri- and poly-atomic molecules as a rule (cf. under H₂O below) unsymmetrical tops. Whereas the general motion of a symmetrical top under no forces is *regular precession*, the general

spectrum. Through this newly added degree of freedom corresponding to the quantum number m_0 , as well as through the greater manifold of possibilities of oscillation the structure of the whole band-system is, as is easy to understand, considerably more complicated than before. This shows itself in the case of H_2O even in the infra-red spectrum, which distinguished itself among the di-atomic molecules by its particular simplicity of design, but which in the case of H_2O consists of a whole array of partial bands that partly overlap.

We here restrict ourselves to the law of the individual partial band, and thus consider only changes of m , whereas we sum up the action of the simultaneous change of m_0 with that of the oscillation state and electronic state in a constant term that we shall not analyse further. If, for the moment, we here also take into consideration the transition $m \pm 1 \rightarrow m$, we get as the component of rotation ν_{rot} of the band formula, and, at the same time (disregarding the constant term), as the law of the partial band, from (7) :—

$$\nu_{rot} = \frac{h}{8\pi^2} \left(\frac{(m \pm 1)^2}{J'} - \frac{m^2}{J} \right) = B' \pm 2B'm + (B' - B)m^2,$$

exactly as in eqn. (2), § 3, and with the rotation of eqn. (6), § 4. But, compared with the earlier expression, there is the following characteristic difference: Whereas m was formerly able to assume all values except zero, we may now, by (10), use only the values $m \geq m_0$. (The corresponding condition as for the final state m , m_0 would also have to be imposed for the initial condition $m \pm 1$, m'_0 , and would here require that $m \pm 1 \geq m'_0$; but this only leads to a further definite restriction for m if we make definite assumptions about the quantum jump $m'_0 \rightarrow m_0$.)

The restriction $m \geq 0$ denotes that in the band spectrum of poly-atomic molecules still more neighbouring lines must drop out on both sides of the zero (null) line. Lenz* first enunciated this conclusion. From the essay quoted on page 418, but which was only published in 1921, we see that Bohr conceived the same idea, particularly as applied to infra-red spectra, some years earlier. This conclusion is confirmed in a convincing fashion in our Fig. 107. Here there is missing in the band spectrum of H_2O not only the zero line $m = 0$, but also the lines $m = 1$ in the positive and negative branch. Thus Fig. 107 proclaims that the molecule of water vapour when emitting the band spectrum in question with the quantum number $m_0 = 1$ rotates about its unique axis, which is approximately the line connecting the nuclei. We here briefly mention in passing that peculiarities also occur in the infra-red of water vapour in the vicinity of the band 6.24μ . Over and above this, Heurlinger has established in his dissertation that in the case of several band-spectra produced by complicated carriers (MgH_2 , etc.) various band lines that

* In the essay quoted in § 1.

are neighbouring to the zero line are dropped out. Runge* appears to have ascertained the same in the case of O_2 bands.

But there is a still more striking consequence of molecular gyroscopic motion, namely *the occurrence of the zero branch* in addition to the positive and negative branches (which are alone present in the cyanogen bands), for example, in the case of H_2O (Fig. 107) and of the above-mentioned complicated carriers, for which Heurlinger established the absence of certain lines. To be able to decide when a zero branch will appear and when it will be absent, we must refer to the principle of correspondence (cf. Note 10g). This states that if the molecule executes a regular precession, the transition $m \rightarrow m$ which was forbidden in the case of pure rotation, becomes admissible; here m denotes the quantum number of the total moment of momentum. Now, as we have to expect pure rotation only in the case of diatomic molecules of an axially symmetrical structure, but more or less regular precession in the case of polyatomic molecules, which are partly or wholly unsymmetrical, the transition $m \rightarrow m$, and hence eqn. (2a) on page 431 is in fact shown to be valid for molecules of this type.

Thus we bring the existence of the zero branch into relationship with the fact that the molecule can, on account of a certain lack of symmetry in its structure, perform a precessional motion.

The fact that there was no zero branch in the case of the cyanogen bands is a further confirmation of this view of the zero branch, in so far as we deny that the carrier of the cyanogen bands in the excited state, too, has no paramagnetic properties (electronic motion with a resultant moment about the axis of figure).

The surest criterion for the existence or non-existence of a moment of momentum resulting from electronic motions is, however, furnished—in the case of molecules as well as of atoms—by the *Zeeman effect*. Unfortunately we are still far from having a systematic survey of the Zeeman phenomena that are possible for band-spectra. It has already been mentioned in the previous section that in the case of the lines of H_2 -bands that have been grouped together into partial bands, of the many-lines-spectrum, no Zeeman effect occurs. In the case of the cyanogen bands only a decidedly small magnetic effect, that varies with the square of the field, has been shown to take place.† In the case of other band-spectra there are cases of anomalous resolution and of negative polarisation, that is polarisation in a reverse sense to that in the normal effect. In view of the many possibilities of the arrangement of the electronic revolutions in the molecule there is no reason for surprise in this. Lenz finds (*loc. cit.*) that, even in the simple case of a di-atomic molecule which is furnished with a moment about the axis of figure due to electronic revolution involving the quantum number m_0 , it is possible for a Zeeman

* Zeeman-Jubiläumshft, *Physica*, **1**, 254 (1921).

† A. Bachem, *Zeitschr. f. Phys.*, **3**, 372 (1920).

effect with reversed sign to occur. But this assumption, which is founded on schematic grounds, does not seem to suffice for the quantitative explanation of the observations in question, and, indeed, the data of observation are far from being sufficient to allow a final judgment.

§ 7. Continuous Spectra.

Besides band-spectra which appear discontinuous if the dispersion is insufficient, there are beyond doubt also really continuous spectra both in emission and in absorption.

The continuous character seems to have been established most securely in the case of those absorption bands that link up with the limit of the H.S. of the alkalis. After having first been observed by Wood in the case of Na they were investigated in detail by Holtzmark.* Our Fig. 64 exhibits the sequence of Na-vapour absorption lines continually increasing in density as far as the series limit, where the figure is cut off. Actually, the absorption region extends further, and, indeed, becomes gradually and continuously darker. Corresponding emission and absorption bands that must be due to *hydrogen*, and, indeed, to *dissociated hydrogen*, have been observed in star spectra at the limit of the Balmer series; they have been worked out and plotted by Hartmann.* The continuous emission spectrum of hydrogen, mentioned on page 203 that was produced by Stark by means of excitation by canal rays is obviously of the same origin as these star-spectra; it begins at $\lambda = 360 \mu\mu$ (limit of the Balmer series) and extends to at least $\lambda = 200 \mu\mu$ with a maximum of darkening at $\lambda = 250 \mu\mu$.

The occurrence of *continuous spectra* in the Röntgen region is well known. The absorption spectra shown in Figs. 58, 59, 61 are analogous to the visible spectra just discussed. They link up with the K- or the L-limits on the side of short waves, that is, they are sharply limited on the *side of long waves*. In addition to this there is the continuous emission spectrum of Röntgen rays, which we called *impulse spectrum* on page 25, and which is sharply cut off on the side of *short waves*.

The theory of the continuous bands that link up with the series limits has been sketched by Bohr.† The exact validity of the frequency hypothesis

$$h\nu = W_a - W_e (1)$$

is retained in it. If a continuous spectrum is to come about, then either the initial or the final states (or both) must form a continuous manifold. The states in question must not then be quantized or, expressed in other words, the electron involved may not, in the initial or the final state, belong to the atomic configuration but must be a *free electron*. A continuous *emission spectrum* arises if an originally free electron is taken

* Physikal. Zeitschr., **18**, 429 (1917).

† Kopenhagener Akademie, Part II., § 6.

part of the G-limit above. De Broglie,* by photographing the magnetic spectrum (or "velocity" spectrum) of the electrons released photo-electrically by a characteristic Röntgen radiation was able to show that the kinetic energy of the released electrons comes out to be less than the $h\nu$ of the exciting Röntgen radiation by exactly the amount of energy corresponding to the nearest Röntgen limit. Ellis † showed the same for γ -rays, where it appeared that for the limit G that is to be subtracted only the K-limit of the element receiving the radiation appears to come into account. The otherwise unknown $h\nu$ of the exciting γ -rays may here be calculated from the known K-limit, and the observed energy of the released electrons. In this case it is noteworthy that the primary γ -rays have shown themselves to be strictly discontinuous, that is they form a line-spectrum; thus a continuous background (cf. p. 34), did not show itself. The conjecture, already expressed on page 172, that the hardness of true γ -lines is probably considerably greater than the lines claimed as γ -radiation by Rutherford and Andrade is thus confirmed here.

After this digression we must revert to continuous spectra. In the case of iodine an emission spectrum has been photographed by Steubing ‡ which appears as a continuous band even at dispersions that completely resolve the (very narrow) band spectrum of iodine. Franck § connects this in a very interesting manner, with the electronegative behaviour of the iodine atom, with its tendency to perfect itself into an 8-shell by taking up a foreign electron (cf. p. 103). The difference between this and the continuous emission spectra considered above consists in the circumstance that the iodine atom need not be ionised to attract an electron to itself, but that rather even in the case of the neutral iodine atom, too, the electron affinity suffices to effect the assimilation of the foreign electron. Here, too, the continuous character of the spectrum corresponds to the continuous distribution of the initial kinetic energy of the adopted electron; equ. (4) continues to stand, with the difference that the quantity G, that is the long wave limit of the continuous spectrum now directly measures the *electron affinity of the iodine atom*. From his measurements of the ionisation potential of HCl, HBr, HI, Knipping || calculates the electron affinity of the halogens, in particular that of I, and finds that they agree excellently with the values obtained by Franck and Steubing. In the case of Br, too, the agreement is perfect; the corresponding continuous band has here been recognised by Steubing in older photographs by Eder and Valenta. In the case of Cl the continuous spectrum is as yet unknown.

According to the principle of correspondence (Note 10), the contrast between line-spectra and continuous spectra is, as Bohr mentions (*loc. cit.*), the same as that between *Fourier's series* and *Fourier's integral*. The

* Address at the Third Solvay Congress, Brussels, 1921.

† Proc. Roy. Soc., 99A, 261 (1921).

‡ Zeitschrift f. Phys., 5, 428 (1921).

§ Ann. d. Phys., 64, 693 (1921).

|| Zeitschr. f. Phys., 7, 328 (1921).

electronic motions belonging to the atomic configurations allow themselves, as long as they are conditionally periodic, to be developed in a Fourier series with respect to time; in general several "libration periods" ($\tau_k = 1/\nu_k$ in the nomenclature of Note 10) serve as the intervals of the development. The motions of a free electron that comes from infinity or is ejected to infinity possess no finite libration periods. They do not allow themselves to be represented by a Fourier series but only by a Fourier integral. According to the principle of correspondence there arise out of the discontinuous frequencies of the members of the Fourier series the discontinuous frequencies of a line-spectrum. But in the same way there arise out of the continuous frequencies of the Fourier integral the infinitely close frequencies of a continuous spectrum.

We must not fail to remark that this indirect mode of inference is totally different from the direct mode at the beginning of this paragraph. Now we are concerned with the course *in time* of the motion and with its representation according to the classical theory of vibration; before, we were concerned only with the *energetic* aspect of the possibilities of motion and its interpretation on the quantum theory.

Finally we turn to the continuous spectra of the Röntgen region. We have already remarked above that the absorption bands that link up on the hard side with the K- or L-limits correspond exactly to the absorption bands that link up with the series limits in the visible region. The fact that emission bands have not also been observed at the same points in the Röntgen region is obviously due to the circumstance that gaps in the atomic structure that have come about in the interior through ionisation are filled in much more easily by electrons from the outer shells than by free electrons.

But we have yet to deal briefly with the *emission spectrum* forced into existence by the impact of the cathode-ray particles (*impulse spectrum*). This is emitted by electrons that do not belong to the atomic configuration in either the initial or the final state. We have to picture to ourselves that the cathode-ray particle that is originally free penetrates only momentarily into the atomic configuration, shoots past the nucleus, is deflected out of its orbit, and then again leaves the atomic configuration along a hyperbolic orbit. In this process, it is immaterial whether the atom as a whole is neutral or ionised. The deflexion of the electron is caused by the whole nuclear charge, not only by an excess charge due to the ionisation. The fact that the electron was also able to exist as a free electron after having passed through the atom is shown at the short-wave limit of the spectrum (p. 178). This corresponds exactly, as we know, to the exciting potential of the cathode-ray. But if the electron were to remain poised in an inner orbit of the atom, the energy of this shell [the quantity hG in the nomenclature of eqn. (4)] would become added to the original energy of the cathode-rays and would produce a harder limit than is observed. It is, however, too arbitrary to assume that the elec-

tron should remain poised exclusively at the periphery ("surface") of the atom.

After this there can scarcely be a doubt about the general view of this most important example of continuous spectra, especially about the quantum interpretation of its short wave limit: it is produced by such electrons as possess the full initial energy of the cathode gradient of potential and lose this energy completely in their passage through the atom. Thus, in this case, the process of retardation leads to complete rest, the remaining spectrum corresponds to processes in which the retarded electron retains a part of its initial energy and escapes out of the atom with it.

Nevertheless everything still remains to be done for the proper theory of this impulse (or "retardation") spectrum. We are not there dealing with *questions of frequency* (these are already decided in the case of a continuous spectrum when the limiting frequency is given), but with *questions of intensity*. How is this frequency distributed over the various parts of the spectrum? How does it increase after leaving the short wave limit? Where is the maximum? How does it decrease in the direction of long wave-lengths? How does the maximum intensity depend on the potential and, in particular, how does it depend on the atomic number of the retarding atom? These questions have for the most part already been exactly answered experimentally (cf. p. 179), but are still quite unexplained theoretically. As in all questions of intensity, at present only the principle of correspondence seems available for formulating an answer; but a satisfactory treatment has not yet been given along these lines.

CHAPTER VIII

THEORY OF FINE-STRUCTURE

§ 1. Preliminaries Concerning the Theory of Relativity. Variability of Mass and Inertia of Energy *

THAT mechanics is concerned only with relative motion is a fact that has been known from earliest times. The statement that a body is in motion has a meaning only if a body of reference is given with respect to which the motion is measured. Whether this body of reference is itself at rest or in uniform motion is indifferent and can never be decided by mechanical observations. Irregular motions of the body of reference or motions in which the direction alters may, on the other hand, be established by observation. Accordingly the principle of *relativity states: it is impossible to prove by mechanical means that the world of material bodies accessible to our senses has a common uniform rectilinear motion.* If we were unable to see the starry firmament, there would be no sense in talking of a progressive motion of the solar system in space. We may also briefly express this as follows: *Mechanics denies absolute space, as it has no means of detecting signs of its existence.*

As our body of reference is only something to which and by means of which we refer our measurements of the changes of position of points under observation, we may appropriately replace it by a mere co-ordinate system of reference. Thus in the sequel we shall use the expression co-ordinate system instead of body of reference, for example, we shall speak of a rectangular system x, y, z . But not every co-ordinate system is of use to mechanics. For example, in the case of two systems that are rotating with respect to each other, only one can be a correct system. The criterion for the correctness of a co-ordinate system may be stated only in rather indirect terms: in it the principles of mechanics must be fulfilled; in particular, a point-mass which is shown to be subject to no external forces must, in accordance with the law of inertia (Newton's First Law of Motion) be at rest with respect to the system or must move uniformly in a straight line. If a system x, y, z has been found correct on this criterion, then so is every other "accented" system x', y', z' which moves uniformly and rectilinearly with respect to the

* Cf. the popular account by Einstein, "The Theory of Relativity" (Messrs. Methuen & Co., Ltd.). A list of translations published by the same firm will be found at the end and on the cover of the present volume: it includes Einstein's original papers and Weyl's "Space—Time—Matter."

former. If we take the direction of relative motion of the two systems as the x - or x' -axis respectively, then (Fig. 109 *a* or *b*) the following relations hold for the momentary position of each point P and its co-ordinates in space and time:

$$x' = x - vt, \quad y' = y, \quad z' = z, \quad t' = t. \quad (1)$$

The special feature in the above way of writing the transformation formulæ is the addition of time as a fourth co-ordinate of the moving mass-point. The time does not become transformed when we pass from one correct or "allowable" system to another such system. *Mechanics deals indeed with space that is relative but with time that is absolute.*

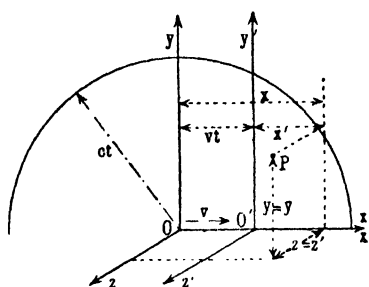

FIG. 109 *a*.

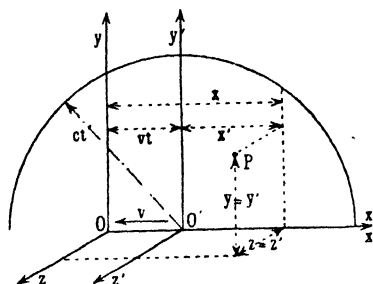

FIG. 109 *b*.

What is the position with respect to the rest of physics, electrodynamics and its sub-section optics which is distinguished by the accuracy of its observations? Does the relativity of space hold here too? We shall first recall two experiments which appear to give evidence against the relativity of space, that is which make absolute space appear as the carrier of physical phenomena. One experiment taken from the realm of optics (Fizeau's experiment), the other from electrodynamics proper (Rowland's experiment). Light propagates itself through *space* with the characteristic velocity c ; it is carried along either not at all or not to the full extent by the body of reference in which it is propagated, if the latter is in motion. We are familiar with the fundamental experiment of Fizeau, in which he directed light through flowing water and determined by interference measurements the difference of path that occurred when the light traversed the water partly in the direction of its motion and partly in the opposite direction. The velocity of light in water was found in this way to be equal, not to $c \pm v$, but to

$$c \pm v \left(1 - \frac{1}{n^2} \right)$$

where n is the refractive index of water, c/n is the velocity of light in water which is at rest, and $v(1 - 1/n^2)$ is the "convection" effect of the moving water. Both quantities may be completely accounted for by

the action of the electrons present in the water on the light; this action is expressed in the magnitude of the refraction index n . Apart from this action, that is, for $n = 1$, the velocity of light would, by the above formula, also be equal to c in flowing water. It is concluded from the non-convection of the light for $n = 1$ and the only partial convection for $n > 1$, which, as it is, may be explained on the ground of the electronic fields, that light is propagated, not like sound through matter, but (apparently) through absolute space. The space that is postulated for the purposes of the motion of light is conceived as being something material and is called the **ether** (*Lichtäther*).

Something similar is shown in the region of true electrodynamics by the proof, carried out in Helmholtz's laboratory by Rowland, that moving electric charges exert a magnetic action. This action is similar to that of an electric current that transports the same quantity through the cross-section of the conductor as is conducted as a result of the motion. Thus the magnitude of this magnetic effect appeared to depend on the absolute velocity of the electric charge. Absolute velocity was affirmed to be velocity with respect to the universal ether.

When scientists made an earnest endeavour to draw final consequences from the idea of the absolute system of reference, the ether contradictions manifested themselves. In this connexion we shall also quote two experiments, as above, one that is optical and one that is purely electro-dynamic.

The final decision rested with the experiment, conceived by Maxwell and carried out by Michelson and Morley with great refinement of technique, directed at proving the progressive motion of the earth in its orbit about the sun. What was impossible mechanically was to succeed optically. If light really propagates itself in the absolute ether it should travel relatively to the earth more slowly in the earth's direction than in the reverse direction. The difference of path would have been manifested by the interference experiments with sufficient accuracy. But they disclosed *no* difference of path; the Michelson-Morley experiment gave a negative result.

The same occurred in the case of an electro-dynamical experiment which, elaborated from an older arrangement by Röntgen, was carried out by Trouton and Noble. A delicately suspended electric condenser represents, on account of the earth's motion, a convection current in the sense implied in Rowland's experiment, and should exhibit magnetic forces that tend to turn the condenser. Or, expressed in other words, the ether wind that blows through the condenser should be made apparent by deflexions of the galvanometer. Here, too, no vestige of the existence of an absolute ether showed itself.

It was inevitable to conclude that the absolute body of reference "ether" was only a fabrication of man and that, in reality, optical and electro-dynamical events take place on the moving earth just as if

the earth were at rest. Generalising this, we had to assume the same result for every body of reference (that is not accelerated). Thus the principle of relativity also holds for optics and electro-dynamics: *it is impossible to prove a uniform motion of the system of reference by means of optical or electrodynamic measurements carried out within the system of reference itself.*

In this negative form the principle of relativity of optics and electro-dynamics is the same as that of mechanics. From the following introductory reflexion we recognise that, in spite of this, it leads to quite different results and that it makes a much deeper incision into our customary ideas.

Let us again consider Figs. 109 *a* and *b* together and let us assume, as an example, that there is a source of light at rest in this system at O' . Let it emit at the time $t' = 0$ a spherical wave; this is indicated in Fig. 109 *b*. We may imagine the accented system as the earth and the system at rest as the sun, with respect to which the earth moves perceptibly uniformly. The fact that we have a spherical wave in the accented system, that is a uniform transmission in all directions is a direct result of the Michelson-Morley experiment. But in the unaccented system, too, we have according to our form of enunciation of the principle of relativity the same transmission in spherical waves. That is, the same event that appears to the "accented" observer as a spherical wave about O' is to be regarded by the "unaccented" observer as a spherical wave about O . Those points of the accented system that are affected by the light disturbance at a definite accented time and which here lie on a sphere about O' are to appear to an unaccented observer at a definite unaccented time to fill a sphere described about O . Our ordinary ideas rebel against this way of thinking; we have accordingly to reform our views of space and time to bring them into agreement with the principle of relativity of optics and electro-dynamics.

Firstly, we wish to meet an objection that has perhaps already thrust itself on the reader. The source of light was, for example, to be at rest in the accented system; it then advances uniformly in the unaccented system during the emission of light. Is it not possible for this circumstance to stand in the way of the equivalence of these two systems of reference? Might not the light-wave in the unaccented system, which starts from the *moving* source of light move differently from the source of light which rests in this system, in such a way that we should have a spherical wave in the unaccented system but not in the accented one, or that both spherical waves might correspond to different values of c ? We overcome this objection by setting up alongside the principle of relativity the **Principle of the Constancy of the Velocity of Light**, which has been amply confirmed by observation.* This principle states that when once

* Since there is, in acoustics, no similar principle of the constancy of the velocity of sound, the following arguments cannot be applied to acoustic or other effects, but only to optical ones.

the light has left its source, it propagates itself, without any recollection of its origin, in accordance with the laws of the optical field, that is in all directions with the same velocity c . The event is at every instant determined by the field distribution at this instant, not by the previous history of the optical excitation, and thus not by the accidental state of motion of the source of light at the moment of emission. The propagation of light is a process due to the action of the field and not an action at a distance over an interval of time. This state of affairs is expressed most directly by the idea of the ether: the transmission is determined by the mechanism of the ether; the source of light, once it has excited the ether, has no influence on the further process. Even if, after the observations of Michelson and Morley and others quoted above, we may no longer recognise the ether, yet we must take over the advantageous features of ether into the realm of etherless optics. We do this by setting up the principle of the constancy of the velocity of light in the above sense, which is thus to be regarded as a condensate and an indispensable remainder of ether physics.

After having sketched in general outline the consequences of the principle of relativity of optics and electrodynamics by the above remarks we must now proceed to a quantitative discussion. We shall set up the transformation formulæ which effect the transition from one optical system of reference to another. These transformation formulæ will be different from the corresponding transformation formulæ of mechanics, eqs. (1). As before, we imagine a light signal to start out from the point O of Fig. 109 *a* at the time $t = 0$. It propagates itself according to the principle of the constancy of the velocity of light with the velocity c in all directions, and thus at the time t it fills a sphere of light of radius ct whose equation is

$$x^2 + y^2 + z^2 - c^2t^2 = 0 \quad . \quad . \quad . \quad (2)$$

We assume that at the time $t = 0$ the point O' of the accented system coincides with the point O of the unaccented system. The light-signal is perceived in the unaccented system, too. For an observer in this system it starts out from O' (cf. Fig. 109 *b*) and, as we know, also propagates itself in this system in all directions with the velocity c , independently of whether the light-signal is considered at rest or in motion, as O or O' . At the time t' it fills the surface of the sphere of light

$$x'^2 + y'^2 + z'^2 - c^2t'^2 = 0 \quad . \quad . \quad . \quad (3)$$

Equations (2) and (3) describe the same event. The desired transformation formulæ are contained implicitly in this identity.

We assume—without proof, for the sake of brevity—that the following relations as in (1) hold for the co-ordinates that are perpendicular to the direction of the relative motion

$$y' = y, \quad z' = z \quad . \quad . \quad . \quad (4)$$

and, also, the transformation formulæ are linear. It then follows from the identity of (2) and (3) that

$$x'^2 - c^2 t'^2 = x^2 - c^2 t^2 \quad (5)$$

Finally we must have

$$x' = k(x - vt), \quad x = k'(x' + vt') \quad (6)$$

where k and k' are constants yet to be determined that can depend only on c and the relative velocity v of both systems. The first eqn. (6) expresses that the point O' ($x' = 0$) in the unaccented system has the position $x = vt$ and is the general statement of the first of eqns. (1). The second eqn. (6) states that, corresponding to the complete equivalence of both systems in Figs. 109 *a* and *b* the point O in the accented system has the position $x' = -vt'$ at the time t' . This equation follows from the first by exchanging the accented and the unaccented co-ordinates and simultaneously $+v$ with $-v$. We now calculate from the second eqn. of (6), taking into account the first, that

$$t' = k \left[t - \frac{x}{v} \left(1 - \frac{1}{kk'} \right) \right] \quad (7)$$

and set the values (6) and (7) for x' and t' in (5). By comparing the corresponding coefficients of x^2 , t^2 and xt , we get the following values that agree

$$k = k' = \frac{1}{\sqrt{1 - \beta^2}}$$

where β is an abbreviation for v/c . Hence our transformation formulæ assume the final form, in accordance with (4), (6), and (7)

$$x' = \frac{x - vt}{\sqrt{1 - \beta^2}}, \quad y' = y, \quad z' = z, \quad t' = \frac{t - \frac{v}{c^2}x}{\sqrt{1 - \beta^2}} \quad (8)$$

By resolving these equations we get

$$x = \frac{x' + vt'}{\sqrt{1 - \beta^2}}, \quad y = y', \quad z = z', \quad t = \frac{t' + \frac{v}{c^2}x'}{\sqrt{1 - \beta^2}} \quad (8a)$$

that is, the same system of equations as (8) if $+v$ and $-v$ are exchanged.

These equations were first set up by H. A. Lorentz and are called the "Lorentz transformation." It is the memorable service of Einstein to have derived them from the principle of relativity, to have applied them in many directions, and later to have elaborated them still further. According to eqns. (8) the change in the space co-ordinates also entails a change in the time co-ordinate; space- and time-transformation are indissolubly connected with each other. Electrodynamics, in giving up *absolute space* (ether), is simultaneously compelled to give up *the idea of absolute time*. We follow Minkowski in calling the four-fold synthesis of

space- and time-co-ordinates the four-dimensional world. If we allow c to assume an infinite value in (8), we get back to the transformation formulæ (1) of ordinary mechanics for $t = 0$.

In reality, however, we may not take $c = \infty$ even in the case of mechanics. There can only be *one* principle of relativity, which permeates mechanics in the same way as electrodynamics. The older mechanical principle of relativity must and can subject itself to that of optics and electrodynamics. Thus we shall claim eqns. (8) for mechanics, too, and shall regard eqns. (1) only as a first approximation to the exact transformation, one that just suffices for mechanics. Actually, the velocities of ponderable bodies are always so small compared with c that terms of the order β^2 [eqns. (8) and (1) differ only by such terms] do not become noticeable here. This, strictly speaking, also banishes the conception of absolute time out of mechanics. In reality the world of physical events is an indivisible four-dimensional manifold. It is only the large value of the velocity of light which brings it about that, for the purposes of mechanics, this four-dimensional world resolves practically into three-dimensional space and one-dimensional, *apparently absolute*, time ($t' = t$).

We shall now call attention to several immediate consequences arising out of the rich content of eqns. (8). In the interests of brevity we shall refrain from giving the ingenious fictitious experiments by means of which Einstein made these consequences more intelligible physically, and likewise from giving a full description of the four-dimensional picture which expresses most fully the fundamental remodelling of our space- and time-ideas as demanded by the theory of relativity. The popularity which this theory gained in wide circles after having been elaborated to the "general theory of relativity" (see below) rests largely on its philosophic content, and this content receives full expression only when clothed in four-dimensional language. On the other hand, here we aim at giving an account of the physical content of the "special theory of relativity" such as is sufficient to enable us to understand the questions of fine structure.

1. Lorentz Contraction. Let us consider a rod of length l at rest in the accented system and lying along the x' -axis. Let the co-ordinates of its end points be $x' = 0$ and $x' = l$. We inquire what is its length in the unaccented system with respect to which the accented system moves along the positive x -axis with the velocity v . For the purpose of measuring the length the observer in the unaccented system has to seek the x -co-ordinates of the end points of the rod, and, indeed, such x -co-ordinates as correspond to *simultaneous* positions of the end points in his time scale. Simultaneous positions in the unaccented time scale are not, however, simultaneous positions in the accented time scale. For example, it follows from the last of eqns. (8) that

$$t = -\frac{v}{c^2}x' \quad . \quad . \quad . \quad . \quad . \quad (9)$$

and so with $x' = 0$ and $x' = l$ we get the two different values

$$t' = 0 \text{ and } t' = -\frac{v}{c^2}l.$$

If we substitute (9) in the first of eqns. (8a) we get

$$x = \frac{1 - v^2/c^2}{\sqrt{1 - \beta^2}} x' = \sqrt{1 - \beta^2} x'.$$

Thus, for $x' = 0$ and $x' = l$, it follows that

$$x = 0 \text{ and } x = \sqrt{1 - \beta^2}l. \quad (10)$$

The length of the rod in the unaccented system is equal to the difference of these two values, that is, equal to $\sqrt{1 - \beta^2}l$. *The rod appears shortened in comparison with its "static length" l .* The contraction is measured by $\sqrt{1 - \beta^2}$. It is greater in proportion as β approaches 1. For $v = c$ the length becomes zero. *From this we already conjecture that c represents an upper limit for all velocities of matter.*

The method of derivation shows that the ground of the Lorentz-contraction is contained in the relative character of the conception "simultaneous." Whether two events are simultaneous, whether the one is perceived earlier or later than the other, depends (to a certain extent) on the relative state of motion of the observer.

2. Addition Theorem of Velocities. Let a point be moving in the accented system with the velocity

$$x' = \frac{dx'}{dt'} \quad (11)$$

parallel to the x' -axis. What is its velocity in the unaccented system? Eqns. (8a) state that

$$dx = \frac{dx' + v dt'}{\sqrt{1 - \beta^2}}, \quad dt = \frac{dt' + \frac{v}{c^2} dx'}{\sqrt{1 - \beta^2}}.$$

From this it follows, by (11)—after division—that

$$\frac{dx}{dt} = \frac{v + \frac{v'}{c}}{1 + \frac{v v'}{c^2}} \quad (12)$$

This is Einstein's Addition Theorem of Velocities. It asserts that *two velocities that are measured in different systems (v' refers to the accented, v to the unaccented, system) are not compounded additively but bi-linearly.*

From (12) we see immediately that we can never exceed the velocity c by superposing two velocities v and v' , both of which are smaller than c , v' being measured in the system of reference that is moving with the velocity v . To prove this, let

$$\beta = \frac{v}{c} < 1 \text{ and } \beta' = \frac{v'}{c} < 1.$$

Then we have, under all circumstances,

$$0 < (1 - \beta)(1 - \beta'),$$

that is, $\beta + \beta' < 1 + \beta\beta'$ or $\frac{\beta + \beta'}{1 + \beta\beta'} < 1$

and, after multiplying by c ,

$$\frac{v + v'}{1 + \frac{vv'}{c^2}} < c.$$

which was to be proved. The same result holds, of course, in the case of repeated addition of velocities. If one of the velocities to be compounded were already to equal c then it would not be increased by the addition of a second velocity, for

$$v + c = c \cdot \frac{1 + \frac{vc}{c^2}}{1 + \frac{vc}{c^2}}$$

Conversely, it follows from (12) that if we now write $\frac{dx'}{dt'}$ and \dot{x} for v' and $\frac{dx}{dt}$, respectively, then

$$\frac{dx'}{dt'} = \frac{\dot{x} - v}{1 - \frac{\dot{x}v}{c^2}} \tag{12a}$$

3. Einstein's Time Dilatation. Let us suppose that at a fixed point of the accented system time-signals are sent out at regular intervals $\Delta t'$. They will also be perceived in the unaccented system as a regular succession, but the intervals Δt will appear longer. For, from the last of eqns. (8a), it follows, if x' is constant, that

$$\Delta t = \frac{\Delta t'}{\sqrt{1 - \beta^2}} \tag{13}$$

We may take as our time-signals the second beats of a clock at rest in the accented system. Observed from a system that is moving with respect to the accented system, the clock does not beat seconds. It appears to lose time as compared with an exactly similar clock that is at rest in the unaccented system. It is common to both the accented and the unaccented system that the time-signals are perceived at different times according to the position of the place of observation, and this circumstance concerns a much simpler fact than the Einstein-dilatation which is included in the time-definition from the very outset.

Or we may take as our time-signals the vibrations of an atom which is at rest in the accented system. Viewed from the unaccented system the vibrations are slower. The spectral line observed in the spectroscope is displaced towards the red compared with the line emitted by the same atom when it is at rest in the unaccented system. (This is the so-called transverse Doppler effect, or Doppler effect of the second order, which is

not to be confused with the ordinary Doppler effect which is of the first order in β and depends on the sense of the direction of motion.)

This Einstein time-dilatation is the reciprocal of the Lorentz space-contraction. Both together lead to the equality of two corresponding events in the accented and the unaccented "world." The contraction in the x -direction (the direction of the relative motion of the two systems) is exactly counter-balanced by the dilatation in the t -direction. The relation

$$dx \, dy \, dz \, dt = dx' \, dy' \, dz' \, dt' \quad . \quad . \quad . \quad (14)$$

holds.

This also follows analytically from the fact that the transformation eqns. (8) have the determinant 1.

4. Variability of Mass. Let us consider the motion of a point-mass P in the plane xy . At the time $t = 0$ let it have the velocity v and let its direction be along the x -axis. At the same moment we attach to it a co-ordinate system $x'y't'$ uniformly with the velocity v . When $t = t' = 0$, P is at rest in this system and has the "static mass" m_0 in it. Let the force that acts on P be $X'Y'$ in the accented system, and XY in the unaccented system. Since the point-mass also gains speed relatively to the accented system in the course of its motion, its mass in this system need no longer be the statical mass m_0 ; let its mass be denoted by m' ; then $m' = m_0$ only at the beginning. The equations of motion (change of impulse = force, cf. p. 194) are for the accented system:

$$\frac{d}{dt'} \left(m' \frac{dx'}{dt'} \right) = X', \quad \frac{d}{dt'} \left(m' \frac{dy'}{dt'} \right) = Y' \quad . \quad . \quad . \quad (15)$$

If we carry out the differentiation in (15) and restrict our attention to the beginning of the motion

$$\left(t' = t = 0, \quad m' = m_0, \quad \frac{dx'}{dt'} = \frac{dy'}{dt'} = 0 \right),$$

then we get for this initial instant:

$$m_0 \frac{d^2x'}{dt'^2} = X', \quad m_0 \frac{d^2y'}{dt'^2} = Y' \quad . \quad . \quad . \quad (16)$$

We translate the accelerations $\frac{d^2x'}{dt'^2}$ and $\frac{d^2y'}{dt'^2}$ into terms referring to the unaccented system.

According to the elementary formula of the law of falling bodies

$$s = \frac{g}{2} t^2$$

we write down the following expressions for the accented and unaccented systems, and for a sufficiently short time $\Delta t'$ and Δt , respectively, during which the motion may be regarded as a uniform acceleration:

$$s' = \frac{1}{2} \frac{d^2x'}{dt'^2} (\Delta t')^2, \quad . \quad . \quad . \quad (17)$$

$$s = \frac{1}{2} \frac{d^2x}{dt^2} (\Delta t)^2 \quad . \quad . \quad . \quad (17a)$$

According to eqn. (10) (Lorentz contraction) and (13) (Einstein dilatation), we have

$$s = \sqrt{1 - \beta^2} s', \quad \Delta t = \frac{\Delta t'}{\sqrt{1 - \beta^2}} \quad (17b)$$

By substituting these values in (17a) we get

$$s' = \frac{1}{2} \cdot \frac{d^2x}{dt^2} \cdot (\Delta t')^2 \cdot (1 - \beta^2)^{3/2} \quad (17c)$$

Comparison with (17) shows that

$$\frac{d^2x'}{dt'^2} = \frac{d^2x}{dt^2} \cdot \frac{1}{(1 - \beta^2)^{3/2}} \quad (18)$$

If we do the same for the y' - and the y -direction, then the eqns. (17) and (17a) hold unchanged if x be replaced by y . But in place of the first eqn. (17b) we get $s = s'$, since no Lorentz-contraction takes place in the y -direction which is perpendicular to the direction of motion. Hence we now have in place of (17c)

$$s' = \frac{1}{2} \cdot \frac{d^2y}{dt^2} \cdot (\Delta t')^2 \cdot (1 - \beta^2) \quad (17d)$$

If we compare this with the equation

$$s' = \frac{1}{2} \cdot \frac{d^2y'}{dt'^2} \cdot (\Delta t')^2,$$

which is analogous to (17), it follows that

$$\frac{d^2y'}{dt'^2} = \frac{d^2y}{dt^2} \cdot \frac{1}{1 - \beta^2} \quad (19)$$

On account of (18) and (19) eqns. (16) pass over into

$$\left(\frac{m_0}{1 - \beta^2} \right)^{3/2} \cdot \frac{d^2x}{dt^2} = X', \quad \frac{m_0}{1 - \beta^2} \cdot \frac{d^2y}{dt^2} = Y' \quad (20)$$

But we must further ask how the accented forces $X'Y'$ transform, that is, what quantities XY the unaccented observer perceives as forces. For this purpose we must borrow from electrodynamics (our question would remain unanswered in mechanics). If $X'Y'$ denote electric forces that act on a charge e at rest in the accented system, then for the same forces in the unaccented system we should have (the charge e' in the accented system is the same as the charge e):

$$X = X', \quad Y = \sqrt{1 - \beta^2} Y' \quad (21)$$

We can now at any rate regard the forces $X'Y'$ that occur in eqns. (16) as forces of electrical origin if we endow our point-mass with a charge (which may, for the rest, be arbitrary) and we may therefore apply eqns. (21) to them. Then eqns. (20) may be written, without reference to the accented system in the form:

$$\left(\frac{m_0}{1 - \beta^2} \right)^{3/2} \cdot \frac{d^2x}{dt^2} = X, \quad \left(\frac{m_0}{1 - \beta^2} \right) \cdot \frac{d^2y}{dt^2} = Y \quad (22)$$

In place of the static mass in eqn. (16) we here have a "moving mass," and indeed we have a different one for the x -direction than for the y -direction. The x -direction is the direction of the instantaneous motion, the longitudinal direction; the y -direction is "transversal" or perpendicular to the motion. The coefficients of longitudinal and transversal acceleration in eqns. (22), namely,

$$m_{long} = \left(1 - \beta^2\right)^{-\frac{3}{2}}, \quad m_{trans} = \left(1 - \beta^2\right)^{-\frac{1}{2}} \quad (23)$$

is (or was) therefore called the longitudinal and the transverse mass. But in Chapter IV., § 1 (cf. p.) we have already emphasised that the fundamental law of mechanics is wrongly called a law of acceleration, and that its correct name is the law of momentum or impulse. Not the kinematic acceleration but the dynamic momentum in the sense of Newton and in that of a natural system of mechanical conceptions defines mass. Accordingly, we re-write eqns. (22) in the form of *the law of momentum for the unaccented system* in the manner of eqns. (15) which expressed the law of momentum for the accented system. They then simply become

$$\frac{d}{dt} \left(\frac{m_0}{\sqrt{1 - \beta^2}} \cdot \frac{dx}{dt} \right) = X, \quad \frac{d}{dt} \left(\frac{m_0}{\sqrt{1 - \beta^2}} \cdot \frac{dy}{dt} \right) = Y \quad (24)$$

Here β now denotes the velocity of our point-mass, which varies during the motion, divided by c ; so that in carrying out the differentiation with respect to t in (24) we must now also take into account the variability of β . As a matter of fact we may easily convince ourselves that the eqns. (24) and (25) become identical for $t = 0$. For

$$\begin{aligned} \frac{d}{dt} \left(\frac{m_0}{\sqrt{1 - \beta^2}} \cdot \frac{dx}{dt} \right) &= \frac{m_0}{\sqrt{1 - \beta^2}} \cdot \frac{d^2x}{dt^2} + \frac{m_0\beta}{(1 - \beta^2)^{\frac{3}{2}}} \cdot \frac{d\beta}{dt} \cdot \frac{dx}{dt} \\ \frac{d}{dt} \left(\frac{m_0}{\sqrt{1 - \beta^2}} \cdot \frac{dy}{dt} \right) &= \frac{m_0}{\sqrt{1 - \beta^2}} \cdot \frac{d^2y}{dt^2} + \frac{m_0\beta}{(1 - \beta^2)^{\frac{3}{2}}} \cdot \frac{d\beta}{dt} \cdot \frac{dy}{dt} \end{aligned}$$

If we now notice that, on the one hand, for $t = 0$, $\frac{d\beta}{dt} = c\beta$ and $c\frac{d\beta}{dt} = \frac{d^2x}{dt^2}$, and that, on the other hand, $\frac{dy}{dt} = 0$, it follows, firstly, that

$$\frac{d}{dt} \left(\frac{m_0}{\sqrt{1 - \beta^2}} \cdot \frac{dx}{dt} \right) = m_0 \left(\frac{1}{\sqrt{1 - \beta^2}} + \frac{\beta^2}{(1 - \beta^2)^{\frac{3}{2}}} \right) \frac{d^2x}{dt^2} = \frac{m_0}{(1 - \beta^2)^{\frac{3}{2}}} \cdot \frac{d^2x}{dt^2}$$

and, secondly, that

$$\frac{d}{dt} \left(\frac{m_0}{\sqrt{1 - \beta^2}} \cdot \frac{dy}{dt} \right) = \frac{m_0}{\sqrt{1 - \beta^2}} \cdot \frac{d^2y}{dt^2}$$

But, by this, our eqn. (24) becomes identical with (22) and this was what was to be proved. Equations (24) show that if the mechanical principles are interpreted correctly *the moving mass is, under all*

circumstances, given by the formula which was set up by Lorentz as early as 1904, namely:

$$m = \frac{m_0}{\sqrt{1 - \beta^2}} \quad (25)$$

It increases according to a uniform and very simple law as the velocity approaches that of light. There is no longer any question of a longitudinal and a transverse mass. This distinction is purely a difficulty created by ourselves and due to an inappropriate view of the fundamental mechanical law. The experimental proof of eqn. (25) is regarded as the *experimentum crucis* of the theory of relativity. The direct proof for the realm of electricity (by means of cathode rays or β -rays) was attempted long ago by Kaufmann (cf. Chap. I, § 4), but was only accomplished by his successors at a much later date by means of refined methods.* It is comparatively easy to prove it indirectly by spectroscopic means, as we shall see at the end of this chapter. In both methods the subject of the experiment is the electron. But our mode of derivation shows that the variability of mass is by no means restricted to the micro-mass of the electron. The theory of relativity asserts that this law holds for every ponderable mass. It is true that the prospects of confirming the law experimentally on this large scale are very meagre.

5. Inertia of Energy. We pass on from the laws of motion of the point-mass to the equation of energy. For this purpose we follow the ordinary procedure of classical mechanics and multiply eqns. (24) by $\frac{dx}{dt}$ and $\frac{dy}{dt}$ respectively, and add them. No essential limitation results from our keeping to plane motion, that is to the two co-ordinates x, y . We shall, however, drop the special assumption that the x -axis is to be in the direction of motion, so that in future we are to take β^2 as standing for the following:

$$\beta^2 = \frac{1}{c^2} \left[\left(\frac{dx}{dt} \right)^2 + \left(\frac{dy}{dt} \right)^2 \right] \quad (26)$$

We then get for the right-hand side:

$$X \frac{dx}{dt} + Y \frac{dy}{dt} = \frac{dA}{dt} = - \frac{dE_{pot}}{dt}$$

as the rate of work (activity) of our force; or, if the latter has a potential, it is the negative rate of change of the potential energy with respect to time. From this it already follows that the left-hand side must be equal to the time change of the part of the energy contained in the motion, namely of the kinetic energy. Thus we have

$$\frac{dE_{kin}}{dt} = \frac{dx}{dt} \cdot \frac{d}{dt} \left(\frac{m_0}{\sqrt{1 - \beta^2}} \cdot \frac{dx}{dt} \right) + \frac{dy}{dt} \cdot \frac{d}{dt} \left(\frac{m_0}{\sqrt{1 - \beta^2}} \cdot \frac{dy}{dt} \right)$$

* Cf. Schäfer and G. Neumann, *Ann. d. Phys.*, **45**, 529 (1914); Ch. E. Guye and Ch. Lavanchy, *Arch. de Genève*, **41**, 286 (1916).

or, if we group the right-hand side appropriately and take into account eqn. (26), we get

$$\begin{aligned} \frac{dE_{kin}}{dt} &= \frac{d}{dt} \left(\frac{m_0}{\sqrt{1-\beta^2}} \right) \left[\left(\frac{dx}{dt} \right)^2 + \left(\frac{dy}{dt} \right)^2 \right] + \frac{m_0}{\sqrt{1-\beta^2}} \left(\frac{dx}{dt} \cdot \frac{d^2x}{dt^2} + \frac{dy}{dt} \cdot \frac{d^2y}{dt^2} \right) \\ &= c^2 \beta^2 \frac{d}{dt} \cdot \frac{m_0}{\sqrt{1-\beta^2}} + c^2 \beta \frac{m_0}{\sqrt{1-\beta^2}} \cdot \frac{d\beta}{dt} \\ &= m_0 c^2 \left(\frac{\beta^3}{(1-\beta^2)^{\frac{3}{2}}} + \frac{\beta}{(1-\beta^2)^{\frac{1}{2}}} \right) \frac{d\beta}{dt}. \end{aligned}$$

If we write the expression in the brackets over a common denominator, then

$$\frac{dE_{kin}}{dt} = m_0 c^2 \frac{\beta}{(1-\beta^2)^{\frac{3}{2}}} \cdot \frac{d\beta}{dt} = \frac{d}{dt} \cdot \frac{m_0 c^2}{\sqrt{1-\beta^2}}.$$

We thus have

$$E_{kin} = \frac{m_0 c^2}{\sqrt{1-\beta^2}} + \text{const.}$$

The integration constant here added is determined by setting the kinetic energy equal to zero when the velocity vanishes. Thus const. = $-m_0 c^2$ and

$$E_{kin} = m_0 c^2 \left(\frac{1}{\sqrt{1-\beta^2}} - 1 \right) \quad . \quad . \quad . \quad (27)$$

Perhaps it is not superfluous to point out that the usual expression $m_0 v^2/2$ for the kinetic energy emerges out of this when c is made to pass to the limit ∞ . We need only develop our expression in series:

$$(1-\beta^2)^{-\frac{1}{2}} = 1 + \frac{\beta^2}{2} + \frac{3}{8}\beta^4 + \dots$$

and, after multiplying by c^2 , to cancel those terms that have c in the denominator. Here, too, classical mechanics appears as a degenerate or mutilated form of relativistic mechanics.

In conjunction with eqn. (25), eqn. (27) allows an interesting interpretation. We write it in the simple form

$$E_{kin} = c^2(m - m_0) \quad \text{or} \quad m - m_0 = \frac{E_{kin}}{c^2} \quad . \quad . \quad . \quad (28)$$

Thus the change of mass produced by the motion is equal to the kinetic energy divided by c^2 .

This result is to serve as the simplest example of the general law of *inertia of energy* which Einstein derived from relativistic considerations (conservation of the centre of gravity during radiation) and which he regards as the most important result of the special theory of relativity. In general, the law states: *every quantity of energy of any form whatsoever represents a mass which is equal to this same energy divided by c^2 ; every quantity of energy in motion represents momentum.* We have already used this law in Chapter II, § 6, p. 95 as an explanation of the

stability of the He-nucleus. Furthermore, in Chapter V, § 1, p. 259, we have reduced the pressure of radiation to the same law, namely, to the momentum of the rays of light.

Our survey of the theory of relativity is, of course, very incomplete and adapted in a one-sided way to meet the requirements of the applications intended in the sequel. Moreover, it was impeded by the necessity of giving an elementary account. The full beauty and clearness of the relationships of relativity come into evidence only when we venture to take up our view-point in Minkowski's four-dimensional world. The somewhat laborious and lengthy calculations which we had to carry out here in Nos. 4 and 5 to derive the relativistic mass and energy, then become superfluous, and allow themselves to be replaced by more appropriate considerations. An account of the higher Hamiltonian mechanics of the theory of relativity will be found in Note 15. Here we merely wish to cast a glance at the powerful extension which we nowadays call the *general theory of relativity*, and shall contrast it with the *special theory of relativity*.

After Einstein had set up the special theory of relativity in 1905, he *straightway proceeded to sketch the structure of the general theory of relativity, in which he had to overcome extremely great difficulties*. He could not rest satisfied with systems of reference in uniform motion that occur in the special theory of relativity. What justification was there that they should play a distinctive part in the special theory? It would be possible to understand why they should be favoured only after the course of phenomena had also been investigated in arbitrary "accelerated" or "rotating" systems of reference. It was only by doing this that he succeeded in disclosing the philosophical scope of the idea of relativity.

And yet another question did not cease to exercise Einstein's mind; although in the special theory of relativity mechanics and electrodynamics were represented very completely, yet the most fundamental force of nature, that of *gravitation* found no place in it. As early as in 1907 (in the *Jahrbuch der Radioaktivität*), Einstein endeavoured to link it up with an extended theory of relativity by pointing out the equivalence of a homogeneous gravitational field with a field in acceleration. But it was only in 1915 that he succeeded in fitting gravitation into the general theory of relativity in its final form. It was on the 29th May, 1919, the memorable day of the general theory of relativity, that the deflexion of the light-rays passing near the sun during an eclipse was confirmed in a striking manner in the case of seven stars, in conformity with the prediction of Einstein (cf. also p. 468 of the following section). From the point of view of this extended theory of relativity the discovery of Copernicus has also to suffer a correction. The decision of the general theory is: it is, indeed, convenient and reasonable to say with Copernicus that the earth is revolving around the sun, but it is not wrong to say with Ptolemy that the sun is revolving round the earth!

§ 2. Relativistic Kepler Motion.

closely § 6, Chapter IV, we now treat the problem of two
 ht of relativity. Let the nuclear charge be E , and the
 $- e$. We disregard the counter-motion of the nucleus.
 nucleus as the origin of a system of polar co-ordinates
 r, ϕ . We shall not write down the differential equations of the motion,
 but concern ourselves with giving a graphical description rather
 than a complete treatment. We may do this, as we shall again take up
 the problem in Note 16, and shall there use the methods of higher me-
 chanics which are remarkably appropriate to the nature of our problem,
 and lead to a complete solution by the shortest route.

Relativistic Kepler motion takes place in an ellipse whose perihelion is
advancing. This means that if we represent the orbit in our polar co-
 ordinates r, ϕ , then its equation is :

$$\frac{1}{r} = C_1 + C_2 \cos \gamma\phi \quad (1)$$

This equation differs from the non-relativistic eqn. (8) of the Kepler
 ellipse on page 234 in having the factor γ in the argument of the cosine.
 This factor has the meaning

$$\gamma^2 = 1 - \frac{p_0^2}{p^2} \quad (2)$$

As before, p is the areal constant of the motion, that is the moment of
 momentum of the electron about the nucleus ; p_0 denotes the abbreviation

$$p_0 = \frac{eE}{c} \quad (3)$$

and has the same dimensions as p . For $c = \infty$ (this denotes the
 passage from relativistic me-
 chanics to the limiting case
 of classical mechanics), $p_0 = 0$,
 $\gamma = 1$, and hence eqn. (1)
 simply transforms into the
 ordinary Kepler ellipse. As
 a matter of fact, on account
 of the magnitude of c , p_0 is
small compared with p , and γ
 is a *little less than 1*, in all
 the cases that come under
 consideration.

The form of the relativistic
 Kepler orbit has been drawn
 in Fig. 110. O is the fixed
 focus, in which the nucleus is
 situated, and P is the initial

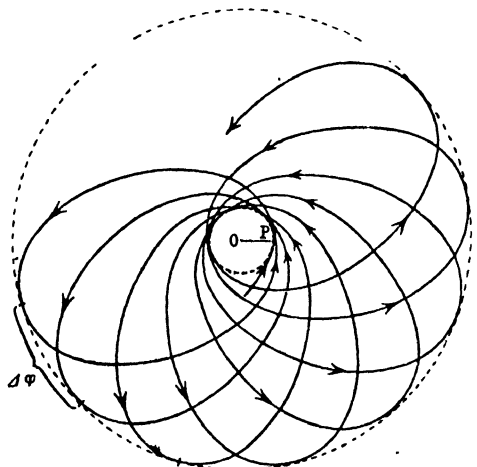

FIG. 110.

position of the perihelion. Let $\phi = 0$ be the straight line OP ; then the orbit does not attain its next perihelion when $\phi = 2\pi$, but when $\gamma\phi = 2\pi$, that is, when

$$\phi = \frac{2\pi}{\gamma} > 2\pi.$$

The motion of the perihelion occurs in the same sense as that of the orbit, and has the angular magnitude

$$\Delta\phi = \frac{2\pi}{\gamma} - 2\pi. \quad . \quad . \quad . \quad . \quad (4)$$

If we refer the motion to a polar system of co-ordinates which participates in the motion of the perihelion, namely, to the system

$$r = r, \quad \psi = \gamma\phi \quad . \quad . \quad . \quad . \quad (5)$$

then we have again an ordinary closed ellipse. In Fig. 110 we have also inserted, as dotted circles, the geometric locus of the successive perihelia and aphelia, the outer and inner envelopes of the orbit.

The motion of the perihelion of the relativistic Kepler ellipse invites us to make a digression into the field of astronomy. As we know, Mercury, in disobedience to Newton's law, exhibits an advance of the perihelion, which, according to Newcomb,* amounts to 43" per century. Can this anomaly be explained in the light of the preceding formula (4)? In the first place, it is clear that our relativistic motion of the perihelion would make itself manifest most readily in the case of Mercury, the planet nearest the sun. For this motion of the perihelion (4), increases as γ decreases, and γ decreases as p decreases. But among all planets the one nearest the sun has the smallest areal constant p . Calculation, however, shows that our relativistic motion of the perihelion is much too small. It would amount merely to 7" per century in the case of Mercury (cf. Note 16). But it was only the wide generalisation of the relativistic standpoint, mentioned just at the end of the preceding section that made it possible for Einstein to explain the observed motion of Mercury's perihelion theoretically. In this way he found that, for Mercury, the theoretical value of the motion of the perihelion was 43" per century!

Reverting to eqn. (1), we now determine the constants C_1 and C_2 of eqn. (1) by means of the major axis a and the numerical eccentricity ϵ of our ellipse measured in the moving system (5), and use exactly the same method as in eqns. (9) and (10) on page 234. For, when $\psi = 0$ (perihelion), $r = a(1 - \epsilon)$, that is

$$\frac{1}{a(1 - \epsilon)} = C_1 + C_2;$$

* A later calculation by Newcomb gave 41". Both numbers are discussed and criticised by E. Grossmann, *Zeitschr. f. Phys.*, 5, 280 (1921).

and when $\psi = \pi$ (aphelion), $r = a(1 + \epsilon)$, that is

$$a(1 + \epsilon) = C_1 - C_2.$$

Accordingly,

$$C_1 = \frac{1}{a} \cdot \frac{1}{1 - \epsilon^2}, \quad C_2 = \frac{1}{a} \cdot \frac{\epsilon}{1 - \epsilon^2},$$

thus

$$\frac{1}{r} = \frac{1}{a} \cdot \frac{1 + \epsilon \cos \gamma\phi}{1 - \epsilon^2} \quad \dots \quad (6)$$

We also take note of the following formula for later reference

$$\frac{1}{r} \cdot \frac{dr}{d\phi} = \frac{\epsilon\gamma \sin \gamma\phi}{1 + \epsilon \cos \gamma\phi} \quad \dots \quad (6a)$$

The *impulses* or *momenta* corresponding to the co-ordinates r, ϕ are :

$$p_\phi = p = mr^2\dot{\phi}, \quad p_r = m\dot{r} \quad \dots \quad (7)$$

They differ from the corresponding impulses obtained earlier in the non-relativistic treatment [eqn. (4) on page 233] only in that the mass m is now variable according to the law :

$$m = \frac{m_0}{\sqrt{1 - \beta^2}} \quad \dots \quad (8)$$

p_ϕ is also now, as indicated in (7), identical with the areal constant p .

We now formulate the quantum-conditions for our two co-ordinates ϕ and r . They are :

$$\int_{\phi=0}^{\phi=2\pi} p_\phi d\phi = nh, \quad \int_{\psi=0}^{\psi=2\pi} p_r dr = n'h \quad \dots \quad (9)$$

In the second integral ψ denotes the angle ψ of eqn. (5). These quantum conditions differ from the corresponding ones (6) on page 234 only in the *integration limits that occur in the radial quantum condition*. We recall the general rule on p. 199: the integration is to be taken over the whole domain of values of the co-ordinate in question. In the case of the azimuth ϕ , this domain of values is an angular rotation; hence we have the limits $\phi = 0$ and $\phi = 2\pi$ in the first integral. In the case of the radius r , however, the total range of values stretches from r_{min} (perihelion) to r_{max} (aphelion), and back again to r_{min} (perihelion). On account of the advance of the perihelion, this range does not correspond to an alteration of ϕ by the amount 2π , but to a change of 2π in $\gamma\phi$; hence we have the limits $\psi = 0$ and $\psi = 2\pi$ in the second integral.

On account of the constancy of p_ϕ the *azimuthal quantum condition* at once gives

$$2\pi p = nh \quad \dots \quad (10)$$

This is the quantum condition of the rotator with which we are quite familiar. In the *radial quantum condition* we take into account eqn. (7) and write, just as in (12) on page 235 :

$$p_r = m\dot{r} = m \frac{dr}{d\phi} \dot{\phi} = \frac{p}{r^2} \cdot \frac{dr}{d\phi}, \quad dr = \frac{dr}{d\phi} d\phi, \quad p_r dr = p \left(\frac{1}{r} \frac{dr}{d\phi} \right)^2 d\phi,$$

and hence, in view of eqn. (6a) :

$$p_r dr = p \epsilon^2 \gamma^2 \frac{\sin^2 \gamma \phi}{(1 + \epsilon \cos \gamma \phi)^2} d\phi = p \epsilon^2 \gamma \frac{\sin^2 \psi}{(1 + \epsilon \cos \psi)^2} d\psi.$$

Hence our radial condition passes over into

$$\int_{\psi=0}^{\psi=2\pi} p_r dr = p \epsilon^2 \gamma \int_{\psi=0}^{\psi=2\pi} \frac{\sin^2 \psi}{(1 + \epsilon \cos \psi)^2} d\psi = n'h \quad . \quad . \quad (11)$$

If we insert the value (10) for p , then we get

$$\frac{\epsilon^2}{2\pi} \int_{\psi=0}^{\psi=2\pi} \frac{\sin^2 \psi}{(1 + \epsilon \cos \psi)^2} d\psi = \frac{n'}{n\gamma} \quad . \quad . \quad (12)$$

Except for the way in which the integration variables are designated, the integral on the left is identical with the integral on the left-hand side of eqn. (13) on page 235. We may therefore use the result there obtained in evaluating it and have

$$\frac{1}{\sqrt{1 - \epsilon^2}} - 1 = \frac{n'}{n\gamma}, \quad \text{that is,} \quad 1 - \epsilon^2 = \frac{n^2 \gamma^2}{(n' + n\gamma)^2} \quad . \quad (13)$$

But whereas, earlier, certain fundamental objections had to be raised against the use of the radial quantum condition, the present radial quantising is free from objection. The relativistic problem is not degenerate, and the co-ordinates r, ϕ are uniquely defined by the nature of the problem. By regarding our earlier problem as the limiting case of the relativistic problem we also justified our procedure for the former.

The size and the form of the orbit are fixed according to quanta by our azimuthal and radial quantum condition. In this way a discrete family of quantised orbits are selected out of the continuous manifold of all the possible orbits.

By using eqns. (2), (3), and (10) we shall express the quantity $n\gamma$ that occurs in (13) as follows:—

$$n\gamma = \sqrt{n^2 - \left(\frac{np_0}{p}\right)^2} = \sqrt{n^2 - \left(\frac{2\pi e H_0}{hc}\right)^2} = \sqrt{n^2 - \left(a \frac{H_0}{e}\right)^2} \quad . \quad (14)$$

We have already encountered earlier the abbreviation

$$a = \frac{2\pi e^2}{hc} \quad . \quad . \quad . \quad (14a)$$

here used, namely, in eqn. (8) on page 213. It signified the speed of rotation of the hydrogen electron in the first Bohr circle divided by c .

Its numerical value ($\alpha^2 = 5.3 \cdot 10^{-5}$) was also determined on the page quoted; it shows that unless $\mathbb{E} \gg e$ the supplementary term $\alpha^2 \left(\frac{\mathbb{E}}{e}\right)^2$ in (14) signifies only a small correction compared with n^2 . As a result of (14), (13) becomes

$$1 - \epsilon^2 = \frac{n^2 - \alpha^2 \left(\frac{\mathbb{E}}{e}\right)^2}{\left[n' + \sqrt{n^2 - \alpha^2 \left(\frac{\mathbb{E}}{e}\right)^2} \right]} \quad (15)$$

Concerning the graphical representation of this family of quantised elliptic orbits we may refer to Figs. 71 and 72 on pages 239, 240. Within the limits of accuracy of the drawing, these ellipses represent the ratio of the major to the minor axis, or, what is the same, the eccentricity, with sufficient truth for the relativistic case, too; as a matter of fact, the difference, as we just saw, is small, being of the order α^2 . We have only to imagine the earlier figures modified with respect to the motion of the perihelion. Concerning the number of different orbits that belong to the same quantum sum $n + n'$ we may also refer to Chapter IV (p. 239).

We now come to the *calculation of the energy*, in which, however, for the sake of brevity, we shall restrict ourselves to circular orbits. The calculation of the energy for elliptic orbits is rather laborious if carried out by the method here adopted; we get at the result much more simply by the method of Note 16, in which less elementary means are adopted.

Let a be the radius of the circular orbit, ω the angular velocity of the electron in this orbit. According to eqns. (7) and (10), we then have

$$p = ma^2\omega = \frac{nh}{2\pi} \quad (16)$$

This is the only quantum condition that comes into consideration in circular orbits. Further, we have the classical condition: the centrifugal force is equal to the Coulomb attraction of the nucleus. It gives us

$$ma^3\omega^2 = e\mathbb{E} \quad (17)$$

It follows by division from (17) and (16) that

$$a\omega = \frac{2\pi e\mathbb{E}}{nh} \quad (18)$$

This is the velocity of the electron in its orbit. If we divide it by c , then, taking into account eqn. (14a), we get

$$\beta = \frac{a\omega}{c} = \frac{a}{n} \cdot \frac{\mathbb{E}}{e}$$

Further, it follows from the mass, which varies with the velocity, that

$$m = \frac{m_0}{\sqrt{1 - \beta^2}} = \frac{m_0}{\sqrt{1 - \frac{\alpha^2}{n^2} \left(\frac{\mathbb{E}}{e}\right)^2}} \quad (19)$$

According to the law of the inertia of energy [eqn. (28) on p. 465], the kinetic energy is

$$E_{kin} = c^2(m - m_0) = c^2 m_0 \left(\frac{1}{\sqrt{1 - \frac{a^2}{n^2} \left(\frac{E}{e} \right)^2}} \right) \quad (20)$$

On the other hand, the potential energy of the Coulomb field is

$$E_{pot} = - \frac{eE}{a}.$$

To have the value of $1/a$ in a convenient form we write eqn. (16) thus:—

$$\frac{1}{a} = \frac{2\pi}{nh} m a \omega$$

and substitute for m and $a\omega$ out of (19) and (18). This gives

$$\frac{1}{a} = \frac{(2\pi)^2 e E}{n^2 h^2} \cdot \frac{m_0}{\sqrt{1 - \frac{a^2}{n^2} \left(\frac{E}{e} \right)^2}}$$

and hence

$$E_{pot} = - \frac{(2\pi e E)^2}{n^2 h^2} \cdot \frac{m_0}{\sqrt{1 - \frac{a^2}{n^2} \left(\frac{E}{e} \right)^2}}$$

Or, taking into account (14a) we get

$$E_{pot} = - \frac{a^2 \left(\frac{E}{e} \right)^2}{n^2} \cdot \frac{c^2 m_0}{\sqrt{1 - \frac{a^2}{n^2} \left(\frac{E}{e} \right)^2}} \quad (21)$$

From (20) and (21) there now follows for the total energy

$$W = E_{kin} + E_{pot} = m_0 c^2 \left[\frac{1}{\sqrt{1 - \frac{a^2}{n^2} \left(\frac{E}{e} \right)^2}} - 1 - \frac{\frac{a^2}{n^2} \left(\frac{E}{e} \right)^2}{1 - \frac{a^2}{n^2} \left(\frac{E}{e} \right)^2} \right]$$

which we may write more conveniently thus:

$$1 + \frac{W}{m_0 c^2} = \sqrt{1 - \frac{a^2}{n^2} \left(\frac{E}{e} \right)^2} \quad (22)$$

We get, instead of this, for *elliptic motion* with its two quantum numbers n and n' :

$$1 + \frac{W}{m_0 c^2} = \left[1 + \frac{\left(a \cdot \frac{E}{e} \right)^2}{n' + \sqrt{n^2 - \left(a \frac{E}{e} \right)^2}} \right]^{1/2} \quad (23)$$

Concerning this general energy formula we merely remark that for $n' = 0$ it can easily be reduced to the simpler formula (22); for the proof of

eqn. (23) we must refer to Note 16. For hydrogen ($E = e$) the eqns. (23) and (22) assume the simpler forms :

$$1 + \frac{W}{m_0c^2} = \left\{ 1 + \frac{a^2}{(n' + \sqrt{n'^2 - a^2})^2} \right\}^{-1/2} \quad (24)$$

and

$$1 + \frac{W}{m_0c^2} = \sqrt{1 - \frac{a^2}{n^2}}$$

respectively.

We can now at once write down the *general relativistic formula of the Balmer hydrogen series* if we enlist the aid of Bohr's fundamental equation

$$h\nu = W_a - W_e \quad (25)$$

(W_a = the energy of the initial orbit of the hydrogen electron for the quantum numbers k, k' ; W_e = the energy of the final orbit for the quantum numbers n, n' .) We then get

$$\frac{\nu}{R} = \frac{2}{a^2} \left[\left\{ 1 + \frac{a^2}{(k' + \sqrt{k'^2 - a^2})^2} \right\} - \left\{ 1 + \frac{a^2}{(n' + \sqrt{n'^2 - a^2})^2} \right\}^{-1/2} \right] \quad (26)$$

This compact formula includes all the spectral phenomena that the hydrogen atom is capable of exhibiting.

It only remains to make a remark about the constants that multiply the expression in the square bracket in our way of writing eqn. (26). From eqns. (25) and (24) we get

$$\nu = \frac{m_0c^2}{h} [\quad] \quad (27)$$

for which we wrote in (26) :

$$\nu = \frac{2R}{a^2} [\quad] \quad (27a)$$

But from the meaning of R and a as defined by

$$R = R_\infty = \frac{2\pi^2m_0e^4}{h^3}, \quad a = \frac{2\pi e^2}{hc}$$

(cf. p. 216 eqn. (16)) we see at once that the two factors in (27) and (27a) agree, and so our mode of writing (26) is justified. The fact that we here used R_∞ in our calculation is due to our having disregarded the counter-motion of the nucleus in this section. To take this into account subsequently (cf. also footnote 1 on p. 476) we shall in the sequel take R as standing for the value R_H (in the case of He it is the value R_{He}) (cf. Chap. IV, § 6, p. 240).

As an analogy to (26) this significance of R gives us the following comprehensive formula for the wave-numbers of the spectra of the hydrogen-type (He^+ etc.) :

$$\frac{r}{R} = \frac{2}{a^2} \left[\left\{ 1 + \frac{\left(a \cdot \frac{h}{e} \right)^2}{\left[k' + \sqrt{k'^2 - \left(a \frac{h}{e} \right)^2} \right]^2} \right\}^{1/2} - \left\{ 1 + \frac{\left(a \cdot \frac{h}{e} \right)^2}{\left[n' + \sqrt{n'^2 - \left(a \frac{h}{e} \right)^2} \right]^2} \right\}^{1/2} \right] \quad (28)$$

The greater part of the present chapter will be devoted to exhausting the content of these formulæ. In this section we shall merely outline its general character and illustrate it by the characteristics of elliptic motion.

Firstly we are arrested by the fact that our present spectral formulæ no longer merely depend on the quantum sums $n + n'$ and $k + k'$; rather, the quantum numbers n, n' and k, k' enter into our formulæ unsymmetrically. *From this it follows that, corresponding to the same quantum sums, the lines that previously coincided are now separated owing to the intervention of relativity.* This separation is due to the correction term which is associated with the small factor $a^2 = 5 \cdot 3 \cdot 10^{-5}$. For this reason the separation is only slight and can be detected only by the most refined means of spectroscopy. The lines that were previously described as coincident are split up into a configuration of close lines. The individual lines of this configuration, its components, determine by their intervals of separation and intensities the **fine-structure** of the line-configuration. When we have become acquainted spectroscopically with the fine-structure, for example, of the hydrogen lines, we shall have ocular evidence not only of the actual occurrence of the elliptic orbits but also of the variability of the electronic mass. Consider, for example, the representation of the various types of orbits in Fig. 72 on page 240.

Whereas the velocity and hence also the electronic mass remains constant in the circular orbits, it alters greatly in the elliptic orbits, particularly in those of great eccentricity. The velocity is small at the aphelion and increases as the perihelion is approached. When the electron is on such an orbit and rushes past in the immediate vicinity of the nucleus, it is subject to the strong field of force in the neighbourhood of the nucleus, and so its mass also increases with its speed. Thus we understand that its energy can be different from that in the circular-orbit, the more different the more eccentric the ellipse, and that a somewhat different position in the spectrum must result for the line-components corresponding to the various orbits.

The motion of the perihelion of the ellipse is also connected with the variability of mass. In particular, the correction term in the expression

$$\sqrt{k'^2 - \left(a \frac{h}{e} \right)^2}$$

owes its origin, according to eqn. (14), to the circumstance that $\gamma < 1$, that is, to the advance of the perihelion. Thus the observation of the fine-structures discloses the whole mechanism of the intra-atomic motions as far as the motion of the perihelion of the elliptic orbits. The complex of facts contained in the fine-structures has just the same importance for the special theory of relativity, and for the atomic structure as the motion of Mercury's perihelion for the general theory of relativity.

§ 3. General Inferences. Fine-Structure and the Relativity Correction.

To make the final formulæ (28) of the last section convenient for calculation we shall develop them in powers of the small quantity α^2 . When E/e is not a great number (H, He⁺), it is sufficient to retain the first two powers of α^2 . This is so in the case of the visible and ultra-violet spectra. For great values of E/e , however, we have also to take into account the third or even the fourth power of α^2 . This occurs in the case of the Röntgen spectra. For extremely great values of E/e (U, Th, etc.) it may even be convenient not to develop α^2 at all but to use the complete formula (28).

After this the calculation becomes simple for the visible spectra. If we denote by S the quantum sum that occurs in the denominator of eqn. (28) of the previous section and that has been modified in conformity with the demands of relativity, then

$$S = n' + \sqrt{n^2 - \left(\alpha \frac{E}{e}\right)^2} = n' + n - \frac{1}{2n} \left(\alpha \frac{E}{e}\right)^2 + \dots \quad (1)$$

and we at once get

$$\left\{ 1 + \frac{\left(\alpha \frac{E}{e}\right)^2}{S^2} \right\}^{-1/2} = 1 - \frac{1}{2} \cdot \frac{\left(\alpha \frac{E}{e}\right)^2}{S^2} + \frac{3}{8} \cdot \frac{\left(\alpha \frac{E}{e}\right)^4}{S^4} - \dots \quad (2)$$

Further, we have, to the requisite degree of approximation in each case,

$$\left. \begin{aligned} \frac{1}{S^2} &= \left[n' + n - \frac{1}{2n} \left(\alpha \frac{E}{e}\right)^2 + \dots \right]^{-2} \\ &= \frac{1}{(n+n')^2} \left[1 + \frac{1}{n(n+n')} \left(\alpha \frac{E}{e}\right)^2 + \dots \right] \\ \frac{1}{S^4} &= \frac{1}{(n+n')^4} [1 + \dots] \end{aligned} \right\} \quad (3)$$

Substituted in (2) this gives

$$\left\{ 1 + \frac{\left(\alpha \frac{E}{e}\right)^2}{S^2} \right\}^{-1/2} = 1 - \frac{1}{2} \frac{\left(\alpha \frac{E}{e}\right)^2}{(n+n')^2} - \frac{1}{2} \frac{\left(\alpha \frac{E}{e}\right)^4}{(n+n')^4} \left(\frac{1}{4} + \frac{n'}{n} \right) + \dots \quad (4)$$

We insert this development in eqns. (28) of the previous section, in which in part the quantum-numbers n, n' of the final orbit, and in part

the quantum-numbers k, k' of the initial orbit, occur. In taking the difference of the two terms in the square brackets the first term 1 cancels out and the factor $2/a^2$, which stands before the brackets, may be divided out. The wave-number ν then occurs as the difference of a *first positive* member that depends on the quantum-numbers n, n' of the *final* orbit and a *second negative* member that depends on the quantum-numbers k, k' of the *initial* orbit. To indicate this, we write

$$\nu = (n, n') - (k, k') \quad . \quad . \quad . \quad (5)$$

and get, for example, for the first term :

$$(n, n') = R \left(\frac{E}{e}\right)^2 \left\{ \frac{1}{(n+n')^2} + \frac{\alpha^2}{(n+n')^4} \left(\frac{E}{e}\right)^2 \left(\frac{1}{4} + \frac{n'}{n}\right) + \dots \right\} \quad (6)$$

In this expression the first member on the right is identical with the representation in terms set up for the hydrogen-like lines in Chapter IV, § 6; this member depends only on the quantum sum $n + n'$. The second member on the right exhibits the influence of relativity. This influence is two-fold. Its first part again depends only on the quantum sum $n + n'$ and amounts to

$$\frac{1}{4} \frac{\alpha^2 R}{(n+n')^4} \cdot \left(\frac{E}{e}\right)^4$$

It effects a general raising of the term* which is equal for circular and elliptic orbits. We call this part the general relativity correction or the relativity correction for circular orbits. In the first term of the Balmer series ($E = e, n' + n = 2$) its ratio to the whole term is

$$\frac{\alpha^2}{16} = 3 \cdot 10^{-6}.$$

On the other hand, relativity brings about a separate increase of the term for the various elliptic orbits; this increase depends on n and n' individually and increases with the eccentricity of the orbit. Its value is:*

$$\frac{n'}{n} \cdot \frac{\alpha^2 R}{(n+n')^4} \cdot \left(\frac{E}{e}\right)^4.$$

We call this part the *resolution of the term*; it is the ground of the *fine-structure of the lines*. For the first term of the Balmer series ($E = e$) and the only elliptic orbit that here comes into account ($n' = n = 1$) the ratio of this resolution to the whole term is:

$$\frac{\alpha^4}{4} = 1.3 \cdot 10^{-5}.$$

* C. G. Darwin has carried out the calculation as strictly as possible for the case when the accompanying motion of the nucleus is taken into account (Phil. Mag., **39**, 537 (1920)). He finds that the nuclear motion expresses itself not only in the Rydberg constant but also in a small additive correction member of the order of magnitude $\alpha^2 m/M$ ($m =$ mass of electron, $M =$ mass of atom), which is of no account practically. The fine-structure remains quite unaffected by it.

These two influences have a common cause, namely, the relativistic variability of mass. As was described at the conclusion of the last section, the increase of mass for the ellipses of great eccentricity, at the perihelion of which the electron rushes past the nucleus with great speed, is greater than for the ellipses with small eccentricity or than for the circle. But there still remains an influence of the relativistic increase of mass for the latter, too, and it is this that expresses itself in our general relativity correction. Of course, this general influence may easily be determined [from eqn. (22) of the preceding section] and has in fact been calculated by Bohr* even before the general theory of quantised elliptic-orbits was in existence.

For the purposes of the Röntgen spectra we must next carry the accuracy of our calculations still further and retain the still higher powers of α^2 that follow. In place of (1), (2) and (3), we have then to write

$$S = n' + n - \frac{1}{2n} \left(\frac{E}{e} \right)^2 - \frac{1}{8n^3} \left(\frac{E}{e} \right)^4 - \frac{1}{16n^5} \left(\frac{E}{e} \right)^6 - \dots \quad (1a)$$

$$\left(1 + \frac{\left(\frac{E}{e} \right)^2}{S^2} \right)^{-1/2} = 1 - \frac{1}{2} \cdot \frac{\left(\frac{E}{e} \right)^2}{S^2} + \frac{3}{8} \cdot \frac{\left(\frac{E}{e} \right)^4}{S^4} - \frac{5}{16} \cdot \frac{\left(\frac{E}{e} \right)^6}{S^6} + \frac{35}{128} \frac{\left(\frac{E}{e} \right)^8}{S^8} - + \dots \quad (2a)$$

and to the degree of approximation requisite in each case :

$$\left. \begin{aligned} \frac{1}{S^2} &= \frac{1}{(n+n')^2} \left[1 + \frac{1}{n(n+n')} \left(\frac{E}{e} \right)^2 + \frac{4n+n'}{4n^3(n+n')^2} \left(\frac{E}{e} \right)^4 \right. \\ &\quad \left. + \frac{8n^2+5nn'+n'^2}{8n^5(n+n')^3} \left(\frac{E}{e} \right)^6 + \dots \right] \\ \frac{1}{S^4} &= \frac{1}{(n+n')^4} \left[1 + \frac{2}{n(n+n')} \left(\frac{E}{e} \right)^2 + \frac{6n+n'}{2n^3(n+n')^2} \left(\frac{E}{e} \right)^4 + \dots \right] \\ \frac{1}{S^6} &= \frac{1}{(n+n')^6} \left[1 + \frac{3}{n(n+n')} \left(\frac{E}{e} \right)^2 + \dots \right] \\ \frac{1}{S^8} &= \frac{1}{(n+n')^8} [1 + \dots] \end{aligned} \right\} \quad (3a)$$

If we substitute (3a) in (2a) we get (if we cancel the 1 and multiply by $-2R/\alpha^2$) as the more complete representation of the term :

$$(n, n') = R \left(\frac{E}{e} \right)^2 \left\{ \frac{1}{(n+n')^2} + \frac{\alpha^2}{(n+n')^4} \left(\frac{E}{e} \right)^2 \left(\frac{1}{4} + \frac{n'}{n} \right) \right. \\ \left. + \frac{\alpha^4}{(n+n')^6} \left(\frac{E}{e} \right)^4 \left[\frac{1}{8} + \frac{3}{4} \frac{n'}{n} + \frac{3}{2} \left(\frac{n'}{n} \right)^2 + \frac{1}{4} \left(\frac{n'}{n} \right)^3 \right] \right\} \\ \left. + \frac{\alpha^6}{(n+n')^8} \left(\frac{E}{e} \right)^6 \left[\frac{5}{64} + \frac{5}{8} \frac{n'}{n} + 2 \left(\frac{n'}{n} \right)^2 + \frac{23}{8} \left(\frac{n'}{n} \right)^3 \right] \right\} \\ + \left(\frac{n'}{n} \right)^4 + \frac{1}{8} \left(\frac{n'}{n} \right)^5 + \dots \quad (6a)$$

* N. Bohr, Phil. Mag., 29, 332 (1915).

We shall make use of this detailed representation in § 5. The expression (6) suffices for the next questions, which concern the visible region of the spectrum. We are here dealing with the *resolution* of the

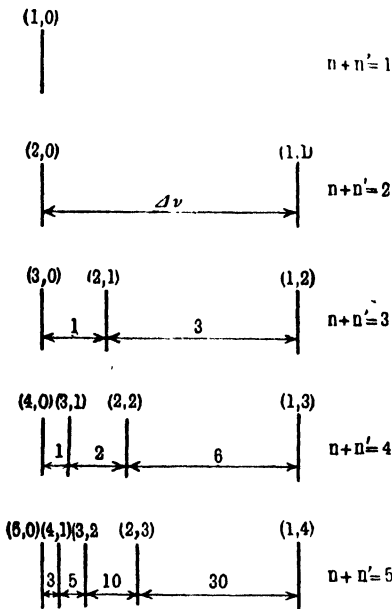

FIG. 111.

series term (n, n') for the various values of n and n' that come into account. Fig. 111 gives a survey of the various types. The symbol for each term is written at the top of each line. The distances between the lines give the differences of the term values and hence also the frequency differences of the spectral lines that are formed from these terms. The numbers written over the arrow lines (the distances between the lines) denote ratios and are explained by eqns. (8a), (9a), and (10). The types that lie vertically below each other cannot be compared directly in magnitude. For the sake of clearness they have been plotted so that the extreme components are at an equal distance apart, whereas, in reality, on account of the increasing term denominators $2^4, 3^4, 4^4, \dots$ they decrease rapidly.

$$n + n' = 1.$$

As we have excluded $n = 0$ (cf. Chap. IV, § 6, p. 238), the *only possible* values that lead to $n + n' = 1$ are $n = 1, n' = 0$. In this case the series term is simple. It corresponds to one and only one circular orbit.

$$n + n' = 2.$$

Corresponding to the two possible resolutions of 2, namely,

$$2 = 2 + 0 \quad \text{and} \quad 2 = 1 + 1,$$

the series term that belongs to $n + n' = 2$ is double. The term (2, 0), the circular orbit, is different from the term 1, 1, the elliptic orbit. Their difference amounts, by eqn. (6), to

$$(1, 1) - (2, 0) = \frac{Ra^2}{2^4} \left(\frac{E}{e}\right)^4$$

This difference of the two terms corresponds spectroscopically to a *line-doublet* of which the frequency difference is

$$\Delta\nu = \frac{Ra^2}{2^4} \left(\frac{E}{e}\right)^4 \quad \dots \quad (7)$$

$$n + n' = 3.$$

A series term for which $n + n' = 3$ is triple, corresponding to the three possible resolutions

$$3 = 3 + 0 = 2 + 1 = 1 + 2.$$

The respective term values (3, 0) circular orbit, (2, 1) elliptic orbit of smaller eccentricity, (1, 2) elliptic orbit of greater eccentricity, increase consecutively. The consecutive term-differences are, by eqn. (6),

$$(2, 1) - (3, 0) = \frac{Ra^2}{3^4} \cdot \frac{1}{2} \left(\frac{E}{e}\right)^4$$

$$(1, 2) - (2, 1) = \frac{Ra^2}{3^4} \cdot \left(\frac{2}{1} - \frac{1}{2}\right) \left(\frac{E}{e}\right)^4 = \frac{Ra^2}{3^4} \cdot \frac{3}{2} \cdot \left(\frac{E}{e}\right)^4.$$

To these there correspond the frequency differences

$$\Delta\nu_1 = \frac{1}{2} \cdot \frac{Ra^2}{3^4} \left(\frac{E}{e}\right)^4, \quad \Delta\nu_2 = \frac{3}{2} \cdot \frac{Ra^2}{3^4} \left(\frac{E}{e}\right)^4 \quad \dots \quad (8)$$

in a triplet of lines. Thus the ratio of the line-intervals in such a triplet of the hydrogen type becomes:

$$\Delta\nu_1 : \Delta\nu_2 = 1 : 3 \quad \dots \quad (8a)$$

$$n + n' = 4.$$

A series term with $n + n' = 4$ is fourfold, corresponding to the following four possible ways of resolution:

$$4 = 4 + 0 = 3 + 1 = 2 + 2 = 1 + 3.$$

The term-value (4, 0) belongs to a circular orbit, the term values (3, 1), (2, 2), (1, 3) correspond to elliptic paths of increasing eccentricity. The consecutive term differences, as calculated by means of eqn. (6), come out as:

$$(3, 1) - (4, 0) = \frac{Ra^2}{4^4} \cdot \frac{1}{3} \cdot \left(\frac{E}{e}\right)^4$$

$$(2, 2) - (3, 1) = \frac{Ra^2}{4^4} \cdot \left(\frac{2}{2} - \frac{1}{3}\right) \left(\frac{E}{e}\right)^4 = \frac{Ra^2}{4^4} \cdot \frac{2}{3} \cdot \left(\frac{E}{e}\right)^4$$

$$(1, 3) - (2, 2) = \frac{Ra^2}{4^4} \cdot \left(3 - \frac{2}{2}\right) \left(\frac{E}{e}\right)^4 = \frac{Ra^2}{4^4} \cdot 2 \cdot \left(\frac{E}{e}\right)^4.$$

The fourfold value of the term gives rise to a quartet of lines with the following consecutive frequency differences:

$$\Delta\nu_1 = \frac{1}{3} \cdot \frac{Ra^2}{4^4} \cdot \left(\frac{E}{e}\right)^4, \quad \Delta\nu_2 = \frac{2}{3} \cdot \frac{Ra^2}{4^4} \cdot \left(\frac{E}{e}\right)^4, \quad \Delta\nu_3 = 2 \cdot \frac{Ra^2}{4^4} \left(\frac{E}{e}\right)^4. \quad (9)$$

Thus the ratio of the line-intervals in such a quartet becomes:

$$\Delta\nu_1 : \Delta\nu_2 : \Delta\nu_3 = 1 : 2 : 6 \quad \dots \quad (9a)$$

$$n + n' = 5.$$

A series term with $n + n' = 5$ is fivefold and gives rise to a quintet of lines. The consecutive frequency-differences in this quintet are in the proportion :

$$\Delta\nu_1 : \Delta\nu_2 : \Delta\nu_3 : \Delta\nu_4 = \frac{1}{4} : \left(\frac{2}{3} - \frac{1}{4}\right) : \left(\frac{2}{3} - \frac{2}{3}\right) : \left(\frac{1}{4} - \frac{2}{3}\right) \quad . \quad (10)$$

$$= 3 : 5 : 10 : 30$$

and so forth for other series terms.

This enumeration of the various possibilities gives rise to a series of general laws.

(a) If the multiplicity lies in the first, that is the *constant* and positive term of a series [represented in eqn. (5) by (n, n')], then it repeats itself without change in *all* members of the series. We have *doublets, triplets, and so forth, with constant frequency differences*, with which we are already familiar in the *subsidiary series*. The component with the smallest wave-number corresponds to the circular orbit; those with increasing wave-numbers correspond to ellipses of increasing eccentricity. The components of the fine-structure follow one another in the sense of Fig. 111, if we allow the wave-numbers as usual to grow from left to right. If we assume that the circular orbit occurs more frequently than the elliptic orbits and that the elliptic orbits become less probable as the eccentricity increases (these two assumptions are not true under all circumstances), then we may expect that the most intense component of the fine-structure in question will lie on the side of long waves and that the intensity decreases step by step as we go from the red to the violet end.

(b) If the multiplicity lies in the second term, that is in the *variable* negative term [represented in eqn. (5) by (k, k')], and if the constant term of the series is simple ($n = 1$, circular orbit), then the multiplicity of the variable term expresses itself without debasement in the fine-structure under observation. Corresponding to the denominators $k + k' = 2, 3, 4 \dots$, the first line of the series becomes a doublet, the second a triplet, the third a fourfold line, and so forth. The range of the configuration, as measured in wave-numbers, decreases as the number increases, on account of the factor $(k + k')^4$ in the denominator of the term. The gradual drawing together of the fine structure as the series advances, to which we have just called attention, forms an analogy to the *decreasing frequency differences* which were observed in the *principal series* of the elements. The analogy is certainly not complete, since the elements that exhibit the ordinary series are not of the hydrogen type. In the case of hydrogen itself the "principal series" here denoted is the ultra-violet series of Lyman (cf. the next section).

On account of the negative sign of the variable term the component corresponding to the circular orbit now lies on the short wave side of the fine structure. The components follow one another in the reverse sense to that in (a) and to that in Fig. 111. The succession of lines in Fig. 111,

as there remarked, gives no picture of the progressive drawing together of the configuration. If we make the same assumptions about the intensity of the components as was made in (a), then the intensity decreases step by step as we go from the violet to the red end.

(c) If both the constant positive term and the variable negative term are multiple, then in the first place (as energy considerations alone show) the quantum sum of the negative term must be the greater. If, for example, the constant term gives us a doublet, then there corresponds to the variable term, taken alone, a triplet in the first series line, a quartet in the second, and so forth. We have first to suppose the *two multiplicities to be superposed* in such a way that the two lines of the doublet consist of three components each in the first series number, of four components each in the second series number, and so forth. In general the line-configuration $(n, n') - (k, k')$ is composed of $(n + n')(k + k')$ components, corresponding to the number that was given earlier for the possible modes of generation of a Balmer line (cf. p. 241). *The mutual distances between the various components bear, according to the above enumeration, simple rational numerical ratios to one another; the order of sequence of the $k + k'$ components of the variable term is the reverse (violet to red) of that of the components of the constant term (red to violet).* A diagrammatic view of this superposition and of the complicated configurations that are hereby involved is given in the figures of the next section.

(d) Whereas we have to compare the hydrogen spectrum with the ordinary *flame- or arc-spectra*, we have in the case of ionised helium the simplest case of a *spark-spectrum* of the hydrogen type. The preceding conclusions are fully applicable in this case, with the scale condition that *the distance between the components, measured in wave-numbers, are magnified as compared with the hydrogen spectrum by the factor $(E/c)^4 = 16$.*

(e) Bohr has already conceived the possibility of the existence of spectra of higher orders (in the case of Li^{++} , cf. p. 224). The factor of magnification of the fine-structures would amount in this case, and altogether in that of double ionisation to $3^4 = 81$ in wave-numbers. The extreme limiting case of these spectra occurs with the Röntgen lines, in particular with those of the heavy metals. Here fine-structures of macroscopic size would manifest themselves: § 5 of the present chapter is devoted to such "coarse structures."

§ 4. Comparison with Experiment.

The constant term $1/2^2$ of the Balmer series of hydrogen gives rise to a *doublet* of constant difference of wave-numbers. The magnitude $\Delta\nu_n$ of this difference will serve us as unit measure in what follows. According to eqn. (7) of the previous section, and since $E = e$, it amounts to

$$\Delta\nu_n = \frac{R\alpha^2}{2^4} = 0.365 \text{ cm}^{-1} \quad (1)$$

Here we have set $\alpha^2 = 5.32 \cdot 10^{-5}$ and $R = 1.097 \cdot 10^5$. In calculating α^2 we used the numbers:

$$e = 4.77 \cdot 10^{-10}, \quad h = 6.55 \cdot 10^{-27}.$$

Among the results of direct observation we quote those in footnote †.

The difference between the results of observation and the theoretical value (1) is partly explained by the influence of the variable term (see below). Concerning the intensity of the two doublet components observation discloses almost without exception that the *more intense* component has the *longer wave-length*, which agrees with our expectations stated under (a) in the preceding section.

Direct observation is rendered difficult owing to the blurred appearance of the H-lines (cf. p. 208). This blurred appearance is due to the heat motion of the emitting H-atoms. As is known from astrophysics, the spectrum of a star is displaced a little towards the violet or the red, according as the star is moving towards or from the observer, whereby the amount of the displacement depends on the ratio of the velocity in the line of sight to that of light (Doppler effect). What is true of stars and their spectra also holds of luminescent gases and their spectral lines. In the latter case, however, we are dealing not with a one-sided displacement towards the violet or the red, but with a broadening of the lines in both directions since velocities in *all* directions, both towards as well as away from the observer, occur in a luminescent gas. The magnitude of these velocities clearly depends on the temperature and the atomic weight of the gas; the higher the temperature the lower the velocities due to heat motion, and the greater the atomic weight, the smaller these velocities. Thus in the case of the hydrogen atom the heat motion is particularly marked, so that, for it, we must descend to very low temperatures (liquid air) to get tolerably sharp lines. The Stark effect (Chap. V, § 4) becomes added to this as a further reason for the blurring of the lines. In the case of hydrogen this causes much stronger resolutions than in that of other atoms. It is not only produced in artificially imposed fields but also under the electric influence of neighbouring atoms which distort the electronic orbits of the emitting atom.

But there is an *indirect method of observation* that has been pursued by Paschen (see below). In it the value of $\Delta\nu_n$ is deduced from the fine-

* These measurements and others quoted are from Gehrcke and Lau, *Physikal. Zeitschr.*, **21**, 634 (1920). Concerning the results of measurement, cf. also *Ann. d. Phys.*, **65**, 564 (1921).

		$\Delta\lambda$	$\Delta\nu$
† Michelson	H α	0.14 Å	0.32 cm. -1
"	H β	0.08 "	0.33 "
Fabry and Buisson	H α	0.132 "	0.306 "
Meissner and Paschen	H α	0.124 "	0.288 "
Gehrcke and Lau	H α	0.117 "	0.272 "
" " "	H β	0.067 "	0.283 "
" " "	H γ	0.051 "	0.271 "

structure of the lines of a more favourable atom (He^+). Paschen gets, as already quoted on p. 209,

$$\Delta\nu_n = 0.3645 \pm 0.0045 \text{ cm.}^{-1}.$$

This value agrees fully with the theoretical value (1). *This clears up qualitatively and quantitatively what previously appeared mysterious in the hydrogen doublet.*

In the Balmer series the multiplicity of the second variable term becomes superposed, according to theory, cf. (c), on the doublet due to the constant term. Consequently the two doublet components on their part consist of a triplet at H_α , of a quartet at H_β , of a quintet at H_γ , and so forth. The intensity of this finer and narrower configuration, expressed crudely (cf. below), *decreases towards the red*, that is in the reverse direction to that of the doublet components, on account of the negative sign of the second term [cf. the previous section under (b)]. We may call the weaker lines of these triplets, quartets, and so forth, "satellites" of the doublet lines, provided that we bear in mind that the difference between satellites and true lines is merely arbitrary. It is just our fine structures that show that the "satellites" that result from the second term form an organic whole with the "lines" of the first term.

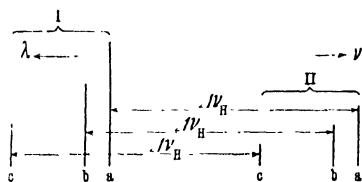

FIG. 112 a

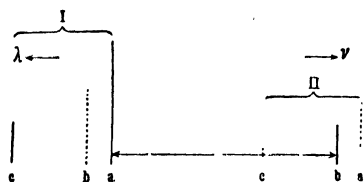

FIG. 112 b.

We now proceed to analyse Figs. 112 a and 113 a which are illustrative of H_α and H_β . The wave-numbers are plotted as increasing towards the right. The length of the lines is at the same time to denote their intensity. We remark at the outset that almost all data that spectroscopists give about intensity are more or less rough estimates. Our theoretical rule, too, on page 247, which we derived from the repeated occurrence of the same orbit in spatial quantising and which we shall apply in what follows, does not claim to be much more. We shall make the relative intensities in a doublet decrease in the ratio 2 : 1, in a triplet 3 : 2 : 1, in a quartet 4 : 3 : 2 : 1, in the order of the circular orbit to the increasingly eccentric elliptic orbits. We shall see presently that this rule of intensity will have to be modified very considerably on account of the *Principle of Selection* and the *Principle of Correspondence*, and that it claims a certain validity only in the limiting case of electric currents of great density.

The following convention is found to be useful to denote briefly the origin of the individual lines. Let us call the multiplicities of the first

term I, II (or I, II, III, . . . , if the first term is not a doublet as in the Balmer series, but gives rise to a higher multiplicity), and the multiplicities of the second term a, b, c, \dots ,—both sequences being numbered in the order of decreasing intensities. Thus the I, II, . . . follow one another in the direction red to violet, and the a, b, c, \dots follow one another, on account of the reverse sign of the second term, in the direction violet to red.

Concerning details, the following is to be remarked. For H_α , Fig. 112 *a*, where

$$\nu = (n, n') - (k, k') \begin{cases} n + n' = 2 \\ k + k' = 3 \end{cases}$$

the principal line in the line-group I corresponds to the transition from the circle (3, 0) to the circle (2, 0); its intensity has been set equal to 1. The "satellites" that immediately link up on the left then correspond to the transition from an initial ellipse to the circle 2, 0 and form together with the principal line the characteristic triplet with the interval ratio $\Delta\nu_1 : \Delta\nu_2 = 1 : 3$ [cf. equ. (8a) of the preceding section]. In accordance with our above rule the intensities of these satellites have been plotted as $2/3$ and $1/3$. In the line group II the principal line of Fig. 112 *a* corresponds to the transition from the circle (3, 0) to the ellipse (1, 1). In accordance with our rule of intensity it has been drawn with the length $1/2$. Two lines associate themselves with it on the left; they correspond to the transition from one ellipse to another, and their intensities decrease from $2/6$ to $1/6$.

The hydrogen doublet $\Delta\nu_n$ occurs in the figure three times, each between components bearing the same symbol, namely, aa, bb, cc . The line-intervals $\Delta\nu_1$ and $\Delta\nu_2$ of the hydrogen triplet are expressed by eqns. (8) of the previous section in terms of $\Delta\nu_n$ as follows [cf. also (1) of this section]:

$$\left. \begin{aligned} \Delta\nu_1 &= \frac{1}{2} \cdot \frac{Ra^2}{3^4} = \frac{1}{2} \cdot \frac{2^4}{3^4} \Delta\nu_n = \frac{8}{81} \Delta\nu_n \\ \Delta\nu_2 &= \frac{3}{2} \cdot \frac{Ra^2}{3^4} = \frac{3}{2} \cdot \frac{2^4}{3^4} \Delta\nu_n = \frac{8}{27} \Delta\nu_n \end{aligned} \right\} \dots \dots \dots (3)$$

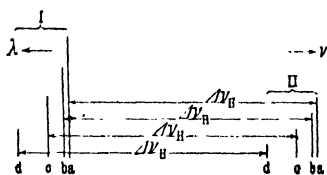
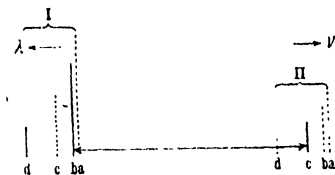
FIG. 113 *a*.FIG. 113 *b*.

Analogous results hold for Fig. 113 *a* which corresponds to the line H_β

$$\nu = (n, n') - (k, k') \dots \begin{cases} n + n' = 2 \\ k + k' = 4 \end{cases}$$

The principal line of the line-group I, the transition from the circle (4, 0) to the circle (2, 0), has been drawn with the length 1. There is linked up with it on the left the characteristic quartet with the interval ratios $\Delta\nu_1 : \Delta\nu_2 : \Delta\nu_3 = 1 : 2 : 6$ [cf. eqn. (9a) of the preceding section] the hypothetical intensity ratios being 4 : 3 : 2 : 1. The same group gives the line-group II, displaced by an amount $\Delta\nu_n$ to the right as a whole. The principal line of the latter corresponds to the transition from the circle (4, 0) to the ellipse (1, 1) and has the intensity 1/2 in our figure. The frequency differences of the quartet are, by eqn. (9) of the preceding section, expressed as follows in terms of $\Delta\nu_n$:

$$\left. \begin{aligned} \Delta\nu_1 &= \frac{1}{3} \cdot \frac{Ra^2}{4^4} = \frac{1}{3} \cdot \frac{2^4 \Delta\nu_n}{4^4} = \frac{1}{48} \cdot \Delta\nu_n \\ \Delta\nu_2 &= \frac{2}{3} \cdot \frac{Ra^2}{4^4} = \frac{2}{3} \cdot \frac{2^4 \Delta\nu_n}{4^4} = \frac{1}{24} \cdot \Delta\nu_n \\ \Delta\nu_3 &= 2 \cdot \frac{Ra^2}{4^4} = 2 \cdot \frac{2^4 \Delta\nu_n}{4^4} = \frac{1}{8} \cdot \Delta\nu_n \end{aligned} \right\} \quad (4)$$

We now apply the *principle of selection* (cf. Chap. V, § 2) and pass on from Figs. 112 a and 113 a to Figs. 112 b and 113 b. In the case in which no external field is present the principle of selection limits the transitions of the azimuthal quantum number to ± 1 , but imposes no restriction on the transitions of the radial quantum number. Let us test its action in detail for H_α and H_β .

In the following table the quantum numbers n, n' of the final orbit, which are compatible with the quantum sum $n + n' = 2$, stand on the left, and the quantum numbers k, k' of the initial orbit, into which the quantum sum $k + k' = 3$ may be resolved stand on the right.

TABLE 49.

	n'	n		k	k'	
I	0	2	←	3	0	a
II	1	1	←	2	1	b
				1	2	c

The arrows mark the transitions for which k increases or decreases by 1, that is those which are alone allowed by the principle of selection. These are the transitions I a, I c, and II b. The transitions II a, I b, and II c, in which k would jump by two units or would remain unaltered are forbidden. Thus, of the six lines of Fig. 112 a only three are left; the omitted lines are dotted in Fig. 112 b.

For H_β ($k + k' = 4, n + n' = 2$) the corresponding scheme is as follows :

TABLE 50.

	n'	n		k	k'	
				4	0	a
I	0	2	←	3	1	b
II	1	1	←	2	2	c
				1	3	d

Here the transitions $I b$, $I d$, as well as $II c$, are possible. On the other hand the transition $I a$ (circular orbit to circular orbit, that is, according to our provisional rule of intensity, the strongest line that is to be expected) is forbidden by our principle of selection; likewise the lines $I c$, $II a$, $II b$, and $II d$, because they would entail a change of the azimuthal quantum number by two, three, or no units. In Fig. 113 b the corresponding lines have been dotted. Thus H_β does not consist of $2 \cdot 4 = 8$ components but, just like H_α , only of 3. The same number of real components is also left, as may easily be counted, in the case of the lines H_γ , H_δ , . . . as the number of unreal components, that is those forbidden by the principle of selection, increases.

Hence in advancing along the Balmer series there is no increase in the number of components of fine structure, but all members have the same number of components, namely 3. On the other hand we know that in the Stark effect, that is, under the influence of an electric field, the number of components increases rapidly with the order-number of the member. It is in agreement with this that our principle of selection, as we saw in Chapter V, § 3, page 273, is invalidated. For the first effect of an electric field consists in this, that the components that would have the intensity zero according to the principle of selection for "free fields," occur with weak intensity; it is only when the field grows still further that perceptible resolution and superposition of the components occur. Our Figs. 112 a and 113 a for H_α and H_β are thus not without physical meaning: *they represent that appearance of the pictures of the fine structure which appears in a tube of intense electrical excitation (condensed current density), as the first indication of an incipient Stark effect.* We shall presently discuss to what extent the intensities marked in the figures are trustworthy in the case of the He^+ -lines, which are more readily observed, and how the electric fields that are acting are determined in a given case.

From Figs. 112 b and 113 b we also read the reason why the observed hydrogen doublet of the Balmer series must lag a little behind the ideal hydrogen doublet. The ideal hydrogen doublet denotes the distance between lines bearing the same names, as aa , bb , and so forth. In the actual measurement, however, the adjustment would be made for the

*maximum** point of intensity of the line-group I and then we should measure from this point to the individual line to which the line-group II reduces itself. The arrow that has been determined in this way (stretching from I *a* to II *b* in Fig. 112 *b*, and from I *b* to II *c* in Fig. 113 *b*) hereby comes out smaller than $\Delta\nu_H$.

The ideal hydrogen doublet would be measured correctly only in the limit when we get to high members of the Balmer series ($H_\delta, H_\epsilon, \dots$), where the fine-structure due to the second term becomes continually narrower and the line-groups I and II contract more and more into the pure doublet of the first term.

In the case of hydrogen we have also become acquainted with the ultra-violet Lyman series and the infra-red Paschen series (cf. p. 207), namely:

$$\nu = R\left(\frac{1}{1^2} - \frac{1}{k^2}\right), \quad \text{and} \quad \nu = R\left(\frac{1}{3^2} - \frac{1}{k^2}\right), \quad \text{respectively.}$$

In the former, the ultra-violet series, the first term is simple, the second is k -fold. The scheme of the possible fine-structures of its lines is represented by the rows of Fig. 111 from the second onwards, but with the right and left sides exchanged, on account of the negative sign of the second term, which conditions the fine-structure. But according to the principle of selection in the case of free fields, these possible fine-structures cannot occur. Rather, only one component of the fine-structure remains preserved in each series member, namely that component in which the azimuthal quantum number jumps from 2 to 1. As a consequence of the principle of selection the Lyman series consists of strictly simple lines. The possible multiplicity of its lines, as represented by Fig. 111, can become visible only in strong electric fields. In the ground-line of the Lyman series, $\lambda = 1216\text{\AA}$ (cf. p. 207) the only component that is possible in a free field corresponds, according to the principle of selection, to the transition from the second Bohr circle (2, 0) to the first Bohr circle (1, 0). In all the other members of the Lyman series, it corresponds to the transition from the elliptic orbit with the quantum number 2 to the first Bohr circle.

In the infra-red series, on the other hand, the k^{th} member would consist of $3k$ components if no account were taken of the principle of selection. The principle of selection reduces this number to 5, as we shall presently see in the case of the analogous He^+ -series.

Of the two influences of relativistic mechanics on the hydrogen lines, the "relativity correction for circular orbits" and the "resolution" (cf.

* This does not differ perceptibly from the centre of gravity of intensity. For in the case of the long wave group of hydrogen, which consists of two components, the satellite (or minor line) is extremely weak compared with the principal line, according to calculations by Krauners (p. 491), if the fields are sufficiently weak; the result is that the centre of gravity of both becomes identical with the principal line. The conditions have been tested again very carefully in detail by R. T. Birge, Phys. Rev., 17, 589 (1921).

p. 476), the former is much less accessible experimentally than the latter which we have just discussed, because it entails very exact absolute measurements. It may therefore suffice to state that in the Balmer series

1. Very slight deviations from the formula

$$\nu = R\left(\frac{1}{2^2} - \frac{1}{k^2}\right)$$

have already been occasionally observed earlier, and

2. That these deviations, according to a paper by Paschen, which we shall presently quote, are of the order of magnitude of our relativity correction $Ra^2/64$ required by theory and bear the correct sign (cf. 476), with $E = e$, $n + n' = 2$.

We now arrive at the true test of our theory, the spectra of ionised helium. They have been photographed by Paschen* and interpreted in close connexion with the theory of the present author, which was conceived about the same time and found its certain support in Paschen's discoveries.

Why are the spectra of He^+ more favourable for our purpose than those of H ? Both are to the same extent simple and theoretically clear; both are produced by one electron and one nucleus. But the He-lines are sharper than the H-lines. The He-atom is four times as heavy as the H-atom; hence its lines are much less broadened by the Doppler effect of the heat motion. Besides this, the He-nucleus is twice as heavily charged as the H-nucleus, and therefore its lines will be less influenced by the Stark effect. Nevertheless the separation of the components is only partly successful even in the case of He, and demands spectroscopic resolution that is very difficult to obtain.

Our first concern is with the so-called "principle series of hydrogen" (cf. Chap. IV, § 2, p. 208), whose formula is (if we discard all relativistic refinements):

$$\nu = 4R\left(\frac{1}{3^2} - \frac{1}{k^2}\right), \quad k = 4, 5, 6, \dots \quad (5)$$

To them there belong the lines (more exactly the line-groups):

$k =$	4	5	6	7	8
$\lambda =$	4686	3203	2733	2511	2385

They constitute series that arise by translating the infra-red series into the violet by multiplying by the factor 4.

The line-group $\lambda = 4686$ (initial orbit fourfold), final orbit threefold) consists virtually of $4 \cdot 3 = 12$ components. The first term of its series representation (5) gives rise to a triplet, I, II, III with the characteristic intervals $\Delta\nu_1 : \Delta\nu_2 = 1 : 3$; the second produces a quadruplet a, b, c, d with the sequence of lines reversed and with the intervals $\Delta\nu_1 : \Delta\nu_2 : \Delta\nu_3 = 1 : 2 : 6$.

* Bohr's Heliumlinien, Ann. d. Phys., 50, 901 (1916).

Fig. 114 *a* shows in its upper row the mutual theoretical position of the 12 components. The component II *d* of the quartet II overlaps quartet I. All component intervals are expressed rationally in terms of the

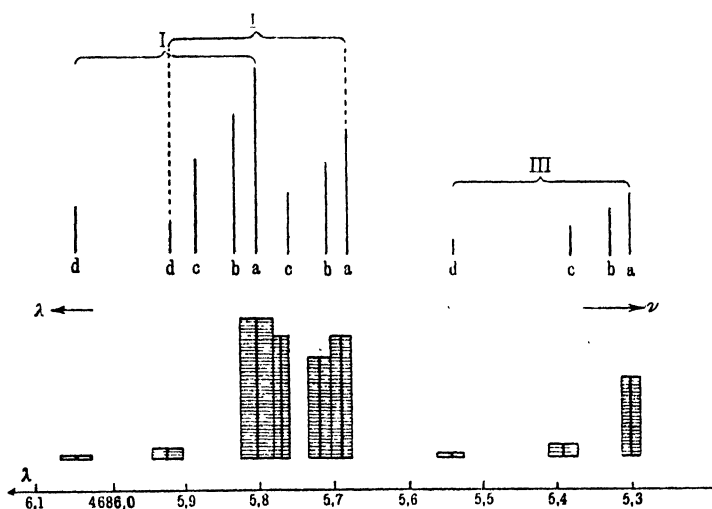

FIG. 114 *a*.—Spark discharge, $k = 4$.

constant of fine-structure a^2 and are therefore also rational multiples of the hydrogen doublet $\Delta\nu_{\text{H}}$. For example, by eqn. (8) on p. 479 and eqn. (1) on p. 481 we get in wave-numbers:

$$\begin{aligned} (\text{II } a - \text{I } a) &= (\text{II } b - \text{I } b) = \dots = 8\left(\frac{2}{3}\right)^4 \Delta\nu_{\text{H}}, \\ (\text{III } a - \text{II } a) &= (\text{III } b - \text{II } b) = \dots = 24\left(\frac{2}{3}\right)^4 \Delta\nu_{\text{H}}. \end{aligned}$$

Further, by eqn. (9) on p. 479 and eqn. (1) on p. 481:

$$(\text{I } c - \text{I } d) = (\text{II } c - \text{II } d) = \dots = 32\left(\frac{2}{3}\right)^4 \Delta\nu_{\text{H}},$$

and so forth.

For the sake of comparison we give in the lowest row of Fig. 114 *a* the experimental picture which is offered when there is a strong spark discharge (great density of current). Starting from the right we see that in the group III the neighbouring components *ab* have fused together and the lines *c* and *d* appear separate. In this representation the width and height of the rectangles indicate the width and intensity of the observed lines. The lines *a* and *b* are also fused together in the groups II and I, but the line I *ab* comes out more strongly than the line II *ab* just as in our theoretical picture. The weak line II *c* appears coincident with I *ab* in the picture. The line I *c* is not separated from II *d*.

Thus we have a striking confirmation of the theory. We almost have a visual picture of the manifold orbits of the electron circulating around the He-nucleus, and we find their twelve combinations represented

exactly in the intervals of the observed partial lines. It is, indeed, just this picture that, on account of its wonderful completeness, served Paschen as a means of calculating the ideal hydrogen doublet.

To give an idea of the experimental difficulty of taking and measuring these photographs we call attention to the scale of wave-lengths attached to the figures, according to which the interval between the extreme lines III *a* and I *d* does not even amount to 0.8 Å.

The picture assumed a different appearance when an *ordinary direct current* was used to excite the He-tube instead of the strong spark discharge; it is different as regards *intensities*, but not as regards the *position of the lines*. The position of the lines is unambiguously determined by the theory, which, however, made only conditional statements about the intensities and possible omission of lines.

If only a weak discharge passes through the tube then the principle of selection holds. This principle allows only those transitions for which $|k - n| = 1$. They are denoted by arrows in the following scheme:—

TABLE 51

	n'	n		k	k'	
I	0	3		4	0	<i>a</i>
II	1	2		3	1	<i>b</i>
III	2	1		2	2	<i>c</i>
				1	3	<i>d</i>

Three lines of the quartet III drop out. They are those corresponding to the transition from $k = 4, 3$, and 1 , to $n = 1$. In each of the quartets II and I, two of the lines are suppressed by the principle of selection, namely, those that correspond to the transitions from $k = 4$ and $k = 2$ to $n = 2$, and from $k = 3, k = 1$ to $n = 3$, respectively. The lines in question have been drawn as dotted lines in Fig. 114 *b*. Thus, of the $3.4 = 12$ components of the line-group, only 5 real ones remain.

The lower part of Fig. 114 *b*, which is by Paschen, now shows that in actual fact the lines III *ab* which we have dotted are wanting in the picture due to a direct current, but that, on the other hand, the lines III *d* and I *d* which we were also compelled to dot are actually present, even if only as weak lines. According to the above we have actually to recognise in this an incipient Stark effect and a transgression of the principle of selection. Thus our picture for the direct current shows convincing agreement with theory as far as the *position of the lines* is concerned.

Concerning the *intensities* the theory must be considerably deepened before we can talk of comparing it with the results of observation. In

any case our crude rule of intensity is contradicted by experience. Whereas, according to this rule, the component II *b* should be weaker than I *a*, II *b* is in reality the strongest component. The necessary deepening of the theory, here too, is effected by the Principle of Correspondence (Note 10). Kramers* finds perfectly satisfactory agreement between Paschen's direct current photographs and the intensities calculated according to the principle of correspondence, and explains why the components III *d* and I *d* do not vanish. He concludes that in the case of Paschen's direct current photographs an (unintended) field of about 100 volt/cm. was probably acting, and in that of Paschen's spark photographs one of about 300 volt/cm.

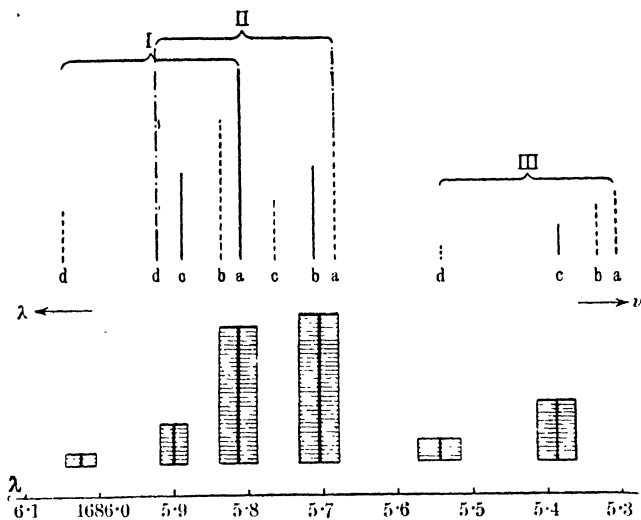

FIG. 114 *b*.—Continuous current, $k = 4$.

In view of the far-reaching importance of the fine structure of $\lambda = 4686$, we are happy to be allowed to reproduce for the first time the photometric measurements in Fig. 115, which Mr. Paschen has kindly placed at our disposal. They are from two original plates taken in the third order. We took them into account in Figs. 114 *a* and *b* in representing the visual impression. Here they are represented objectively by the galvanometric deflexions of a thermo-electric photometer. The individual photometric observations are marked by \circ and \times in the case of the direct current and the spark, respectively. In place of the rectangles drawn above we now see continuous curves expressing the blackening of the plate with well-defined maxima. The fact that the components III *a*, *b* are wanting in the direct current curve, in accordance with the principle of selection, and that the components II are pro-

* In the dissertation quoted on page 275, and in particular page 374 and the footnote to page 372.

nounced in comparison with the components I comes out particularly clearly in this curve representation. In general we see that the differences between the two diagrams and in what theory leads us to expect are only differences in intensity.

In series (5) we pass on to the line group

$$\lambda = 3203,$$

$$\nu = R \left(\frac{1}{3^2} - \frac{1}{5^2} \right).$$

It consists theoretically of a combination of a triplet with a quintet, in the first place, and has thus 15 components in all. The quintet (on account of the denominator 5^4) is contracted more than the previous quartet. That is why the quintets I and II hardly overlap any more. If, however, we apply our principle of selection and draw up a table analogous to Table 51, we see that here, just as in the case of $\lambda = 4686$ (and in that of the remaining members of the series), only five real components remain.

In the experimental picture (direct current diagram) of Fig. 116, III *d* and II *c* are measured separately, and II *c* is measured as the

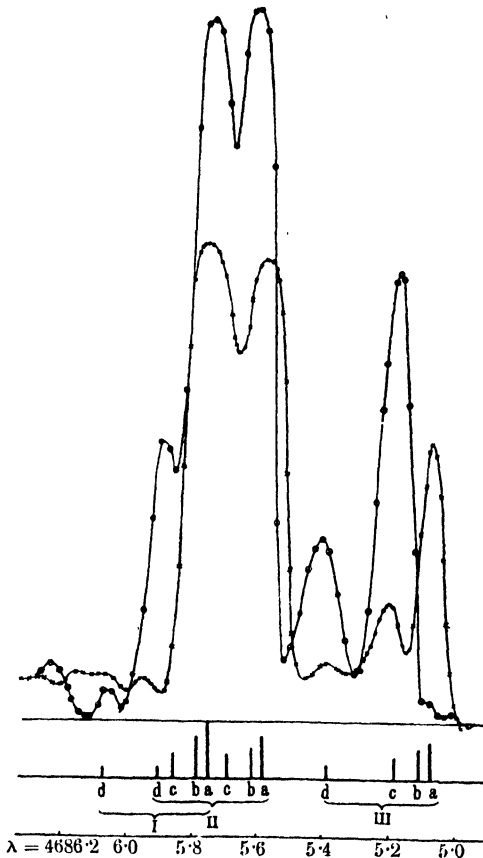

FIG. 115.

strongest component; the other three components II *e*, I *b*, I *d* are fused together. Besides this, the components III *e* and I *e* occur as very weak lines; they should be wanting, according to the principle of selection, and have been produced by the action of an unintended electric field. Here, too, our rule of intensity is in conflict with the results of observation and has to be deepened by means of the principle of correspondence.

The experimental picture for direct currents becomes particularly simple in the case of the next group of lines

$$\lambda = 2733, \quad \nu = R \left(\frac{1}{3^2} - \frac{1}{6^2} \right).$$

Here the sextet of the second term is already so contracted that in observation it appears unresolved everywhere. Accordingly, Fig. 117 exhibits the *pure triplet of the first term with the characteristic interval-ratio 1 : 3.*

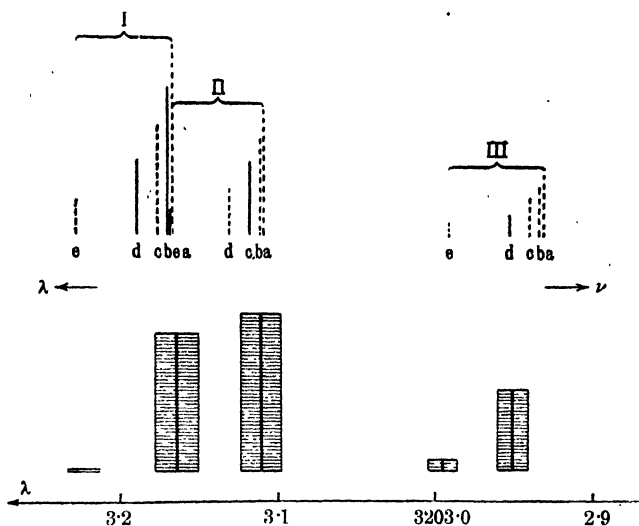

FIG. 116.—Continuous current, $k = 5$.

Paschen has also investigated the second of the He^+ -series mentioned on page 207, the "Pickering series," erroneously called the "II subsidiary series of hydrogen," namely,

$$\nu = 4R \left(\frac{1}{4^2} - \frac{1}{k^2} \right) \quad k = 5, 6, 7 \dots$$

On account of the first term the fine structure is a quartet with the interval-ratios 1 : 2 : 6. The much narrower multiplicity due to the

second term could not be resolved. The first three lines of the quartet also coincided, forming a blurred component. In addition to the latter, however, the *fourth* line of the quartet, which is not so close, could in most cases be measured as a weak component on the violet side of the spectrum. The measurements yielded values corresponding fully with the prediction of theory. The wave-lengths of the principal lines of this series have already been noted, as given by Paschen's measurements, in

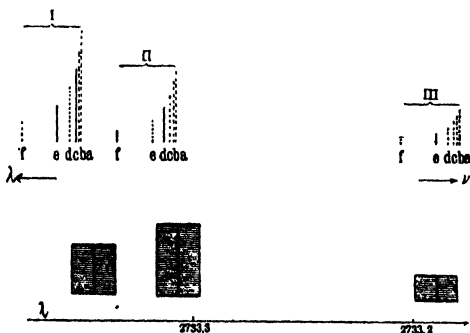

FIG. 117.—Continuous current, $k = 6$.

The wave-lengths of the principal lines of this series have already been noted, as given by Paschen's measurements, in

Table 25 on page 223, and have been placed alongside the neighbouring Balmer lines.

As Bohr remarks, it was a piece of good fortune for the development of spectral theory that the principle of selection did not come out accurately valid in Paschen's direct current photographs and that it was put quite out of action in Paschen's spark photographs. It is just the weak components forbidden by the principle of selection that enabled Paschen to use his photographs to confirm the postulates of the theory which the present author originally set up without being aware of the principle of selection. The development of spectral theory would probably have been delayed for years if Paschen's photographs had corresponded to the ideal conditions of a free field.

Merely in passing we call attention to the comparison of hydrogen spectra with spectra that are not of the hydrogen type in Chapter VI, § 2. In the accompanying Fig. 86 we have depicted the various energy levels of sodium and have compared them with those of hydrogen by attaching the letters H_a , H_b , H_γ . Whereas we formerly said that in the transition to hydrogen the differences of the energy-levels become straightened out within each step, we may now say that indications of these differences remain preserved even in the case of hydrogen in the fine structure of its lines in such a way that the energy-levels become distinctly diminished but that their number remains exactly the same.

Corresponding to this, the number of times that the Balmer lines H_a , H_b , H_γ occurred in the Scheme II on page 336 agrees exactly with the number 3 of the components of the fine structure, which we have now derived for the Balmer lines under the conditions of free fields. Linking up H_a with the three-term expressions $2p - 3d$, $2p - 3s$, $2s - 3p$, as we did earlier, signifies just the same as now drawing the three arrows for the transitions of the azimuthal quantum number $3 \rightarrow 2$, $1 \rightarrow 2$, $2 \rightarrow 1$ in Table 49. The same applies to the infra-red hydrogen lines labelled "Paschen-Ritz" in the earlier scheme or to the He^+ -lines labelled "Fowler," of which the most important representative is $\lambda = 4686$. In accordance with the earlier scheme we have allocated them to the five-term expressions $3d - 4b$, $3d - 4p$, $3p - 4d$, $3p - 4s$, $3s - 4p$; the five arrows in our present Table 51 correspond to them in turn. The ground of this complete parallelism is clearly to be found in the principle of selection for the azimuthal quantum number that holds for the spectra which are not of the hydrogen type in just the same way as for the fine structures.

But we infer, further, that *the fine structures of the hydrogen spectra do not correspond to the doublet or triplet structures of the spectra which are not of the hydrogen type, but to their various series.* Hydrogen exhibits *no analogy* to the doublet structure of the lines of the alkalis or the triplet structure of the lines of the alkaline earths. Conversely, the existence of the hydrogen doublet in Balmer's series denotes that in the

language of spectra which are not of the hydrogen type we may interpret the term $R^2/2$ equally well as the term $2p$ or the term $2s$.

This fundamental comparison entails important consequences affecting the view of the *Zeeman effect*. The doublet-triplet structures, as we know, are caused to contract by a strong magnetic field; their anomalous Zeeman effect becomes changed through the Paschen-Back transformation into the normal effect. Is the same result to be expected in the case of the line structures of hydrogen? No; indeed, just as two accidentally neighbouring lines, for example, an H.S. line and a N.S. line, in a spectrum that is not of the hydrogen type do not affect each other magnetically, no more do we expect two fine-structure components of hydrogen to disturb each other magnetically. Just as the Zeeman effects of the former lines simply become superposed and in given cases interpenetrate each other, so must the normal triplets of the hydrogen components simply become added without interfering with each other.

When the author investigated the Zeeman effect of hydrogen from the point of view of relativity in 1916,* he compressed the result into the sentence: "The Zeeman effect is not influenced by the fine structure," and he imagined that he had to regard this as a contradiction to observation. For Paschen and Back had found certain polarisation anomalies to occur in hydrogen,† which they claimed to be a direct consequence of the strong magnetic fields that were applied. But nowadays we are convinced that these anomalies are to be ascribed to the influence of the electric field in the tube. As a matter of fact, Hansen and Jacobsen ‡ have conducted very careful measurements of the Zeeman effect for the He^+ -line $\lambda = 4686$, reducing the subsidiary electrical influences as far as possible, and they succeeded in establishing that the Zeeman effect then essentially looks normal and, at any rate, manifests no similarity with the Paschen-Back effect. This important result gives the final touch to our knowledge of the Zeeman effect of hydrogen and allows us to assert the following:

When the Balmer lines are resolved magnetically each of the three components of the fine structure passes over into a normal triplet; the resultant nine components become superposed and interpenetrate without disturbing one another. We have already dealt with the position of the corresponding orbital planes on page 302. Of the four transitions that are not bracketed in Table 35 the last two are equal as regards energy and thus coincide § in observation.

The circumstances are somewhat different in the *Stark effect* for

* Physikal. Zeitschr., **17**, 502 (1916). The whole influence of relativity consists in a very minute increase of the normal resolution of the order of the fine structure constant α^2 , which we may pass by as being unobservable here.

† Ann. d. Phys., **40**, 960 (1913). Cf. also F. Croze, Compt. rend., **154**, 1410 (1912); **155**, 1607 (1912); **157**, 1061 (1913).

‡ Kopenhagener Akademie, 1921; Mathem.-phys. Mitteilungen, III, p. 11.

§ Namely the transitions $012 \rightarrow 002$ and $021 \rightarrow 011$.

hydrogen. We may compare the ordinary Stark effect with the Paschen-Back effect since it represents a simplified type which comes about only under the influence of *strong* fields (see p. 388 concerning the definition of "strong" and "weak"). On the other hand, the Stark effect for *weak* fields, the theory of which has been evolved by Kramers (cf. the quotation on p. 285), links up with the fine structure of the hydrogen lines, and represents, as it were, an anomalous Stark effect, the ground of which lies in the original complicated line structure. Hence when the electric field increases no pure superposition occurs in this case, but the resolved components of fine-structure influence one another mutually and become simplified to the normal type of the Stark effect. The reason for this contrary behaviour is clearly the entirely different action of magnetic fields and electric fields. In the case of the magnetic field there is a mere precession of the original Kepler orbit; in that of the electric field these orbits are deformed.

§ 5. Regular and Irregular Doublets of the X-ray Spectra

From the minute hydrogen doublet a direct road leads, passing through the fine-structure lines of ionised helium, to the doublets of the X-ray spectra (cf. the conclusion of § 3 of this chapter). The hydrogen doublet is produced in the field of a singly charged nucleus: the line structure of He^+ is produced in the neighbourhood of a doubly charged nucleus. The Röntgen spectra emerge from the interior of the atom, and hence originate in the field of a highly charged atomic nucleus. The magnification factor of the fine structure in the case of He^+ as compared with the hydrogen doublet amounts, in wave-numbers, to 2^4 . But in the case of X-ray spectra of an element whose atomic number is Z it increases to Z^4 (we assert this with due reservations for later when we give more accurate data). For $Z = 92$ (Uranium), this gives

$$92^4 = 7.2 \cdot 10^7,$$

that is, a magnification* of seventy millions in comparison with the doublet of H!

We become familiar with the detailed data of observation in Chapter III, § 6. Above all, we shall deal with the L-series. The "L-doublet" occurs between the lines ($\alpha'\beta$), ($\gamma'\delta$). In the case of the heavier elements the line-pairs ($\epsilon\eta$), ($\zeta\theta$), (κ) become added. The interpretation of this constant doublet difference was contained in Table 12, page 159; all

* This statement refers to the *frequency difference* $\Delta\nu$. On the other hand, the *wave-length difference* $\Delta\lambda$ is essentially independent of Z (cf. p. 161). Since the spectrometer measures the ratio of the wave-length λ to the constant d of the crystal lattice (cf. equ. (3) on p. 129), the accuracy of the fine-structure measurements is practically the same for all the atomic numbers Z . The fact that the fine structures in the Röntgen region may be measured with much greater ease and certainty than those in the visible region is not due to the greater value of $\Delta\nu$, but to the much smaller value of d , that is to the much finer lattice which may now be used, thanks to the smallness of the wave-lengths.

lines of the L-series start from various initial states and are directed to the L-shell. But the energy level of the latter is double; it consists of an upper L_1 -level and a lower L_2 -level situated beneath it. (We shall treat of the L_3 -level later.) The difference of level between L_1 and L_2 determines the L-doublet.

We are now able to expose the reason for the difference of the L_1 - and the L_2 -level. The K-shell belongs to the quantum number 1 and is therefore *single*. The L-shell has the quantum sum 2 and is therefore *double*. For the present we shall argue as if the L-shell were not multiply occupied, and shall therefore talk only of one electron, which describes the "L-orbit." Now the L-orbit is either a circle (2, 0) (azimuthal quantum number 2, radial quantum number (0) or an ellipse (1, 1) (azimuthal and radial quantum number 1). The energy of the elliptic orbit is *greater* (if we discard the sign), but *less* if we take the sign into account, than the energy of the circular orbit, by an amount that is due to the relativistic increase of mass. Accordingly the lower level L_2 belongs to the elliptic orbit, and the higher level L_1 to the circular orbit. If we regard the circular orbit as the more frequent (more probable) one, then we have to expect that the lines that end in the higher level L_1 , that is those of longer wave-length, are more intense; and this agrees with observation.

We pass on from the energy W of the L-orbit to the "term" - W/h. The "L-term" is common to all lines of the L-series, and, corresponding to the levels L_1 and L_2 , occurs in two forms, as the " L_1 -term" and as the " L_2 -term." It is the positive and first term of the L-series. Hence our statements about the constancy of the L-doublet and about the relative intensities of its components are therefore particular applications of the general assertions in § 3a.

The quantitative representation of the L_1 - and the L_2 -term is given by eqn. (6a) on page 477 with all necessary accuracy. We have there to set $n = 2$, $n' = 0$, for the L_1 -term, $n = n' = 1$ for the L_2 -term and we get:

$$\begin{aligned} (2, 0) &= R \left(\frac{h\nu}{e} \right)^2 \left[\frac{1}{2^2} + \frac{1}{4} \frac{a^2}{2^4} \left(\frac{h\nu}{e} \right)^2 + \frac{1}{8} \frac{a^4}{2^6} \left(\frac{h\nu}{e} \right)^4 + \frac{5}{64} \frac{a^6}{2^8} \left(\frac{h\nu}{e} \right)^6 + \dots \right] \\ (1, 1) &= R \left(\frac{h\nu}{e} \right)^2 \left[\frac{1}{2^2} + \frac{5}{4} \frac{a^2}{2^4} \left(\frac{h\nu}{e} \right)^2 + \frac{21}{8} \frac{a^4}{2^6} \left(\frac{h\nu}{e} \right)^4 + \frac{429}{64} \frac{a^6}{2^8} \left(\frac{h\nu}{e} \right)^6 + \dots \right] \end{aligned} \quad (1)$$

The difference of these two terms gives us the size of the L-doublet in wave-numbers, namely,

$$\begin{aligned} \Delta\nu_L &= (1, 1) - (2, 0) \\ &= R \left(\frac{h\nu}{e} \right)^4 \frac{a^2}{2^4} \left[1 + \frac{5}{2} \frac{a^2}{2^2} \left(\frac{h\nu}{e} \right)^2 + \frac{53}{8} \frac{a^4}{2^4} \left(\frac{h\nu}{e} \right)^4 + \dots \right] \end{aligned} \quad (2)$$

Our representation of the L-doublet is fully determined and expressed rationally by the fine-structure constant $a^2 = 5.3 \cdot 10^{-5}$ by the Rydberg

frequency $R = R_\infty$ (it is clear that we may discard the accompanying motion of the nucleus in the case of the heavier elements), and by the nuclear charge E . We must now first become clear about the latter.

It would suggest itself to us first to set E/e equal to the "true nuclear number," that is, to the atomic number Z of the atom. We know, however, that there is a K-shell within the L-orbit, and that the electrons of this K-shell screen off the nuclear charge. In addition, the L-shell is also multiply occupied and its electrons will also act so as to tend to screen off the true nuclear charge. Hence, in place of the "true nuclear charge," we get an "effective nuclear charge" which is smaller than Z . We set

$$\frac{E}{e} = Z - s \quad . \quad . \quad . \quad . \quad . \quad (3)$$

As we are not able to calculate the "screen number" s^* from theory, we get its value from observations, thus we include it as a parameter which is at our disposal. To give us a first general idea we moreover cancel the higher relativistic terms in (2) and hence write

$$\Delta\nu_L = \frac{R\alpha^2}{2^4} (Z - s)^4 \quad . \quad . \quad . \quad . \quad (4)$$

This is the theoretical formula that has been transposed from hydrogen (or semi-theoretical, since we introduce the parameter s) to a first rough approximation. We compare it with the empirical formula that we evolved at the end of § 6; namely, the eqn. (4) of Chapter III,

$$\frac{\Delta\nu}{R} = \frac{5.3 \cdot 10^{-5}}{2^4} (Z - 3.5)^4 \quad . \quad . \quad . \quad . \quad (5)$$

These two formulæ agree not only in their general form but also in their numerical value. We recognise in this a first confirmation of the quantum and the relativistic view of the L-doublet by the results of observation, and, further, we read from it the empirical value 3.5 for our screen number s .

Eqn. (5) once again refers us to the law of the approximate constancy of $\Delta\lambda$, which served, as in Chapter III, page 161 to recognise doublet lines that belong together. From our present point of view this law is clearly proved by the fact that $\Delta\nu$ is proportional to the fourth power of the atomic number, that ν varies with the square of the atomic number, in the manner indicated by Moseley, and that

$$\Delta\lambda = \frac{\Delta\nu}{\nu^2}$$

The constancy of $\Delta\lambda$ which is not exactly true but only approximate then follows among other things from the fact that the screen constants in $\Delta\nu$ and ν need not be equal (cf. p. 509).

* We have chosen the letter s in view of Chap. II, p. 74.

Eqn. (4) assumes a still more interesting form, if we introduce into it the value of the hydrogen doublet from eqn. (1) on page 481:

$$\Delta\nu_{H} = \frac{R\alpha^2}{2^4}$$

Eqn. (4) then becomes

$$\Delta\nu_L = \Delta\nu_{H}(Z - s)^4 \quad . \quad . \quad . \quad (6)$$

We illustrate its content by means of Table 52 and Fig. 118. In the first column of Table 52 we have a selection of the values of $\Delta\nu_L/R$ for steps

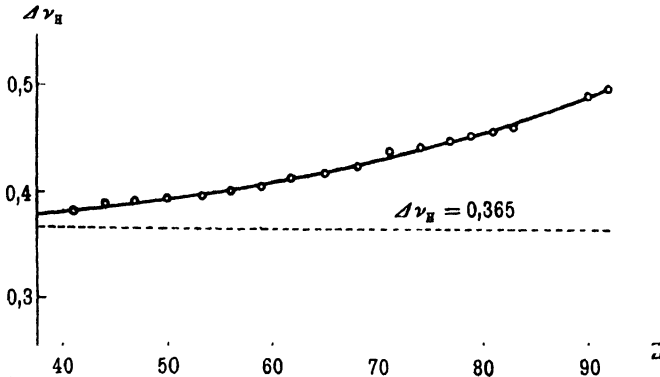

FIG. 118.

of three units on the average; they link up with Table 15. In the second column we have the values of $\Delta\nu_L$ itself, in the third those of $\Delta\nu_{H}$, as they come out by eqn. (6), that is by dividing by $(Z - s)^4$. Whereas the

TABLE 52

Z	$\Delta\nu_L/R$	$\Delta\nu_L$		
41	Nb	6.89	$7.56 \cdot 10^3$	0.382
44	Ru	9.49	$1.041 \cdot 10^6$	0.387
47	Ag	12.69	$1.393 \cdot 10^6$	0.389
50	Sn	16.73	$1.836 \cdot 10^6$	0.393
53	J	21.71	$2.382 \cdot 10^6$	0.397
56	Ba	27.70	$3.040 \cdot 10^6$	0.400
59	Pr	35.03	$3.844 \cdot 10^6$	0.405
62	Sm	43.95	$4.823 \cdot 10^6$	0.412
65	Tb	54.38	$5.968 \cdot 10^6$	0.417
68	Er	66.85	$7.336 \cdot 10^6$	0.424
71	Cp	82.5	$9.05 \cdot 10^6$	0.436
74	W	98.54	$1.0813 \cdot 10^7$	0.438
77	Ir	118.64	$1.3019 \cdot 10^7$	0.446
79	Au	133.80	$1.4683 \cdot 10^7$	0.452
81	Tl	150.49	$1.6514 \cdot 10^7$	0.458
83	Bi	169.73	$1.8626 \cdot 10^7$	0.466
90	Th	250.86	$2.7529 \cdot 10^7$	0.492
92	U	278.71	$3.0585 \cdot 10^7$	0.499

$\Delta\nu$'s change by two powers of 10 in the course of the table, the values of $\Delta\nu_{II}$ remain appreciably constant. The slight increase that is still manifest in the last column may be interpreted quite naturally and is directly postulated by the higher members due to relativity which were provided for in eqn. (2) but cancelled in eqn. (6). This advance becomes more apparent in Fig. 118. Here the values of $\Delta\nu_{II}$, calculated according to eqn. (6), have been plotted as ordinates against the abscissa Z . We see how the interpolated curve drawn through these points approaches a constant limit for small values of Z ; this agrees excellently with our ideal hydrogen doublet

$$\Delta\nu_{II} = 0.365 \text{ cm}^{-1}.$$

Thus *the fact of the existence of the fine-structure may be followed through the whole system of elements, from hydrogen to uranium. The L-doublet appears as a gigantic magnification of the hydrogen doublet.*

But we wish to pursue the quantitative statement of the L-doublet to its final issue, that is, we shall not stop at the first approximation, but shall also take into account the higher corrections due to relativity. This will at the same time give us a criterion for the accuracy of our value 3.5 for s , the screen constant, and we can convince ourselves that for the whole series of elements the L-doublet is accurately represented, within the limits of errors of observation, by our relativistic formula.

We may proceed by calculating the value of $E/e = Z - s$ separately for each element from formula (2). Thus we start from

$$\frac{\Delta\nu}{R} = \frac{a^2}{2^4} (Z - s)^4 \left(1 + \frac{5}{2} \frac{a^2}{2^2} (Z - s)^2 + \frac{53}{8} \frac{a^4}{2^4} (Z - s)^4 + \dots \right). \quad (7)$$

and after multiplying by $2^4/a^2$ we get the square root by using the binomial expansion. In this way we get

$$\frac{2^2}{a} \sqrt{\frac{\Delta\nu}{R}} = (Z - s)^2 \left(1 + \frac{5}{4} \frac{a^2}{2^2} (Z - s)^2 + \frac{81}{32} \frac{a^4}{2^4} (Z - s)^4 + \dots \right) \quad (8)$$

We eliminate the member $(Z - s)^4$ out of (7) and (8) by forming

$$\frac{2^2}{a} \sqrt{\frac{\Delta\nu}{R}} - \frac{5\Delta\nu}{R} = (Z - s)^2 \left(1 - \frac{19}{32} \frac{a^4}{2^4} (Z - s)^4 + \dots \right). \quad (9)$$

We may, without having scruples, use the first approximation obtained in (4) for the corrective member on the right. We then get

$$(Z - s)^2 = \left(\frac{2^2}{a} \sqrt{\frac{\Delta\nu}{R}} - \frac{5\Delta\nu}{R} \right) \left(1 + \frac{19}{32} \frac{a^2 \Delta\nu}{R} \right). \quad (10)$$

The formula thus obtained denotes the inverse of eqn. (2) as given by a logical approximation.

It is treated numerically in Table 53. The first column repeats the values of $\Delta\nu/R = L\beta - La'$ contained in Table 15. The second column

gives the values of $Z - s$, as calculated from eqn. (10), whereby the value $5.315 \cdot 10^{-5}$ (cf. § 7) was set for a^2 . In the third column we have the resulting values of the screen number s itself. The mean of all the values of s is, in round numbers,

$$s = 3.50.$$

As we see, the individual values of s fluctuate without regularity about the mean value. We cannot avoid concluding from this that *the structure of the atom within the whole sequence from $Z = 41$ to $Z = 92$ has a uniform design in its innermost parts and follows the same general plan.* In view of the addition of new shells in the outer part of the atom, and, in certain cases, their rearrangement at certain points of the periodic system (rare earths and so forth, cf. p. 108) this uniformity is by no means an obvious necessity.

TABLE 53.

Z		$\Delta\nu/R$	$Z - s$	s	Z		$\Delta\nu/R$	$Z - s$	s
41	Nb . . .	6.89	37.50	3.50	63	Fu . . .	47.19	59.48	3.52
42	Mo . . .	7.70	38.53	3.47	64	Gd . . .	50.66	60.48	3.52
44	Ru . . .	9.49	40.54	3.46	65	Tb . . .	54.38	61.49	3.51
45	Rh . . .	10.48	41.53	3.47	66	Ds . . .	58.30	62.49	3.51
46	Pd . . .	11.56	42.52	3.48	67	Ho . . .	62.46	63.50	3.50
47	Ag . . .	12.69	43.49	3.51	68	Er . . .	66.85	64.00	3.50
48	Cd . . .	13.97	44.52	3.48	70	Ad . . .	76.1	66.5	3.5
49	In . . .	15.29	45.50	3.50	71	Cp . . .	82.5	67.7	3.3
50	Sn . . .	16.73	46.50	3.50	73	Ta . . .	92.70	69.52	3.48
51	Sb . . .	18.29	47.50	3.50	74	W . . .	98.54	70.49	3.51
52	Te . . .	19.94	48.50	3.50	76	Os . . .	111.08	72.51	3.49
53	J . . .	21.71	49.49	3.51	77	Ir . . .	118.64	73.50	3.50
55	Cs . . .	25.60	51.48	3.52	78	Pt . . .	125.92	74.49	3.51
56	Ba . . .	27.70	52.46	3.54	79	Au . . .	133.80	75.51	3.49
57	La . . .	30.01	53.46	3.54	81	Tl . . .	150.49	77.50	3.50
58	Ce . . .	32.38	54.44	3.56	82	Pb . . .	160.02	78.56	3.44
59	Pr . . .	35.03	55.46	3.54	83	Bi . . .	169.73	79.58	3.42
60	Nd . . .	37.86	56.49	3.51	90	Th . . .	250.86	86.57	3.43
62	Sm . . .	43.95	58.50	3.50	92	U . . .	278.71	88.51	3.49

Mean: $s = 3.492$.

What is more important for us than the constancy of s is the accuracy with which the quantum number 2 is confirmed by our calculation and the unmistakable appearance of the relativistic law in the progressive magnification of the doublet interval. The latter circumstance also illuminates a point which remained in obscurity in the remarks of Chapter III, namely, the increasing curvature of the graph lines of $\sqrt{\nu}/R$ in Figs. 51 and 53 of the K- and L-series. If the Röntgen spectra were given with rigorous accuracy by a formula of the Balmer-Moseley type, then $\sqrt{\nu}/R$, when plotted as a function of the atomic number, would be represented by a straight line. But the addition of the relativity corrections of the first and higher order (cf. eqn. (1) at the beginning of this

chapter) causes this line to become increasingly curved upwards as Z increases as was actually to be seen in Figs. 51 and 53.

Hitherto we have followed in the footsteps of the hydrogen model, and have purposely calculated as if the L -orbits, those that are elliptic as well as those that are circular, are each described by a single electron. The accompanying action of the other electrons of the L -shell that are undoubtedly present was taken into account only by introducing the available screen number s . Now, there is no difficulty in imagining a circular orbit occupied by *several* electrons. If q electrons are distributed regularly around a circle they exert a mutual radial repulsion which is tantamount to a screening of the nucleus to the extent of s_q unit charges. If there are besides these, p electrons within the circle

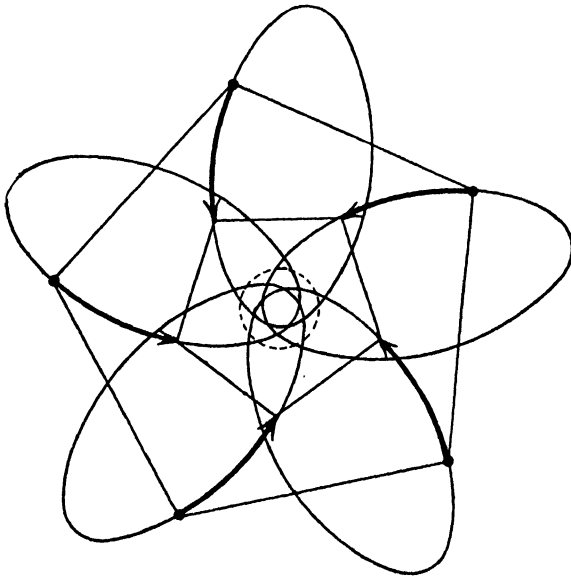

FIG. 119.

and near the nucleus, then the whole screening of the nuclear charge amounts to $s = p + s_q$ for the singular orbit (cf. Chap. II, p. 74).

The case is different with elliptic orbits. It is clearly not possible to arrange several electrons on *one* elliptic orbit without thereby destroying the Coulomb character of the field of force. But it is certainly possible to distribute the electrons among so many ellipses as there are electrons (namely, q). These ellipses are inclined to one another successively at the angle $2\pi/q$, and are situated symmetrically about the nucleus. We have drawn a "group of ellipses" * for $q = 5$ in Fig. 119. These ellipses are

* That such an arrangement is a possible form of motion of several electrons was communicated to the author personally by Mr. F. Pauer. But it had already been described earlier by J. W. Nicholson, *Phil. Mag.*, **27**, 557 (1914).

traversed by the q electrons in such a way, the same for each, that all the q electrons pass through the corresponding aphelia and perihelia at the same moment, respectively. If the electrons are joined up by a sequence of straight lines, then the latter will at every moment constitute a regular polygon (of q sides) which alternately contracts and expands. It is clear that in this pulsating polygon the repulsions exerted on one electron by all the remaining electrons must by symmetry give a resultant which passes through the nucleus and which, as in the case of the circle, is represented by the nuclear defect s_q . The circular orbit that is multiply occupied is distinguished from the ellipses of a group only by the fact that the q circular orbits appear coincident to the eye. *The single ellipse that is multiply occupied would be a false generalisation of the multiply occupied circular orbit; the true generalisation is given by the group of ellipses.*

The conception of grouped ellipses shows that the actual similarity of the L-doublet to the hydrogen type may be brought into accord with the multiple occupation of the L-shell so long as we regard the L-shell to be a multiply occupied circle in one part of the atoms and as a group of ellipses in the other part. Yet, a number of weighty objections speak against the truth of this picture. We need not, it seems to us, take exception to the ingenious interlocking of the q elliptic orbits as being something unnatural; indeed, we may recognise this as an indication of the high degree of harmony of motion that holds sway in the interior of the atom. But how is this harmony of motion to be preserved in face of the many disturbances due to the electrons of the other shells, particularly when we consider, as J. M. Burgers* first pointed out, that the grouped ellipses intersect the K-shell? In Fig. 119 we have dotted in the K-shell as a "K-ring" in its correct relative size. The figure shows that the ellipses penetrate into the interior of this ring when the whole is drawn in one plane. This co-planar arrangement of all the L-electrons in the grouped ellipses is a further weighty objection. How are the electrons to be made to confer distinction on one plane? By a natural elaboration of the idea of a group of ellipses Landé has indeed extended the polygonal symmetry to the polyhedral symmetry of a cubic arrangement (cf. p. 104). But in the region of Röntgen spectra the difficulty at once arises that when the L-series is excited an electron is removed from the cubical 8-shell. What picture are we to form of a cube which has lost one of its eight corners? But the most serious objection to polygonal as well as to polyhedral symmetry is the following: As we have already said above, in order not to destroy the symmetry we should have to assume that the elliptic and circular modes of motion occur in *different* atoms, and that, accordingly, *one* part of the atom exemplifies the L_1 -level, *another* part the L_2 -level. Now in addition to the L_1 - and

* In his dissertation for Leyden University: *Het Atoommodel van Rutherford-Bohr*, p. 161. Haarlem, 1918.

the L_2 -level there is also an L_3 -level. Moreover, as we saw in Chapter III and as we shall show in greater detail in the next section, there are 5 M-levels and not less than 7 N-levels, quite apart from the O- and P-levels that have to be added in the case of elements with higher atomic numbers. But if we distribute L_1 and L_2 among different atoms, we must also do the same with L_3 , and with the M- and N-levels. Hence we should have to postulate not two, but at least $1 \cdot 3 \cdot 5 \cdot 7 = 105$ different species of one and the same atom, corresponding to the possible combinations of the various levels with one another. That is already absurd in itself.

Moreover, this standpoint also leads to direct contradictions with experiment. Let us, for example, imagine two atoms that only differ in that the L-shell is developed as an L_1 -level in the first and as an L_2 -level in the second. When an electron is removed from the K-shell and raised to the surface of the atom, the effective nuclear charge of the L-shell increases by 1; accordingly the shell contracts, and since energy is liberated by this process of contraction the L-shell performs some of the work of elevation necessary for the K-excitation. Thus the work of excitation becomes reduced through the presence of the L-shell and, naturally, also through that of the other shells. But the amount of energy contributed by the L-shell is different according as it appears in the form of the L_1 - or the L_2 -level. For if we apply the nomenclature of Chapter IV, § 5, then the energy of the L-shell *before* the K-excitation, that is, in the undisturbed atom, is, according to eqn. (6) on page 476,

$$\frac{W}{h \cdot R} = \frac{1}{2^2} \{Z - p - s_{q1}\}^2 + \left(\frac{1}{4} + \frac{n}{n}\right) \frac{a^2}{2^4} \{Z - p$$

On the other hand, its energy after the K-excitation (whereby the distribution number of the K-shell, that is, the electrons occupying it, has decreased from p to $p - 1$) is:

$$\frac{W}{h \cdot R} = q \frac{1}{2^2} \{Z - (p - 1) - s_{q1}\}^2 + \left(\frac{1}{4} + \frac{n}{n}\right) \frac{a^2}{2^4} \{Z - (p - 1) - s_{q1}\}^2 \quad (12)$$

The contribution of the L-shell to the work used in effecting the K-excitation is the difference of (11) and (12). As n and n' , the quantum numbers of the respective levels occur separately in this difference, this contribution is, as we said, different for L_1 and L_2 . Since n'/n becomes equal to 0 for the L_1 -level and equal to 1 for the L_2 -level, the difference in the contributions of the L_2 - and L_1 -levels becomes

$$\left. \begin{aligned} \Delta \frac{W}{h \cdot R} &= q \frac{a^2}{2^4} \left\{ \{Z - p + 1 - s_{q1}\}^2 - \{Z - p - s_{q1}\}^2 \right\} \\ &= 4q \frac{a^2}{2^4} (Z - p - s_{q1})^2 + \dots \\ &= 4q \frac{a^2}{2^4} Z_{v,q}^2 + \dots = \frac{4q}{Z_{v,q}} \cdot \frac{\Delta v_{1,1}}{R} + \dots \end{aligned} \right\} \quad (13)$$

where $\frac{\Delta v_2}{R} = \frac{a^2}{Z^4}$ by eqn. (4) denotes the L-doublet $L_2 - L_1$. Hence the K-limits of the two atoms would have to differ by the amount* (13). And, indeed, since the contribution of the L_1 -shell is less than that of the L_2 -shell, the K-limit would be harder in the presence of an L_1 -shell than in that of an L_2 -shell. Further, it follows from this that the L-doublet $K(a'a)$ of the K-series must be greater than the L-doublet of the L-series by the same amount (13). But, when calculated, this difference comes out, if q be set equal to 8, to 6.4 v/R units for Mo atomic number (42), 8 for Rh (45), 45 for W (74). Contrast with this Table 16 in Chapter III, § 6, according to which $K(aa')$ agrees with $L(a'\beta)$ to the extent of, at most, 0.2 v/R units.

From all this we must infer that the orbits that give rise to the different levels must actually all occur in the same atom.† But then there can be no such pronounced symmetry as we assumed in the grouped ellipses or in the cubic arrangement. The problem of the arrangement of the electrons within the atom, regarded from an elementary point of view, becomes hopeless. It seems equally hopeless to explain the defect in the nuclear charge namely, $s = 3.50$ in an elementary and pictorial manner; nor did we succeed in doing this satisfactorily even when using the picture of the group of ellipses. Our formula for the L-doublet does not hereby lose any of its practical value. It cannot, indeed, be regarded as an equation that has been derived from theory, like the formula for the hydrogen doublet, but it stands as an empirical equation that has been brilliantly confirmed.

At any rate the general behaviour of the L-doublet speaks unmistakably in favour of the correctness of a relativistic and quantum standpoint. *The fact that the L-doublet depends on the atomic number Z , and that it corresponds to the quantum-number 2, leaves little room for doubt that we must regard the L-doublet itself as a macroscopic copy of the microscopic hydrogen doublet.*

But our relativistic formula of the fine-structure preserves its validity and value, not only in the case of the L-doublet, but also in that of the M- and N-doublets, and thus furnishes us with a principle of sub-division for the multiplicity of M- and N-lines. We give the name **regular doublet** to each pair of energy-levels that are connected with each other by such a fine structure formula. Later we shall show that besides these regular

* Just as there would have to be two K-limits, so also there would have to be two K β -lines, separated by the interval (13). The theory of this "intermediate doublet" [cf. Zeitschr. f. Phys., 5, 1 (1921)], of course, falls to the ground with the assumption that the levels L_1 and L_2 are formed in different atoms, that is, not in the same atom.

† This conclusion is entirely contradictory to the view that the author held formerly, and that was maintained in earlier German editions of this book. But it coincides with the views of Bohr expressed in his letter to "Nature," cf. page 59. According to Bohr, it is an indispensable condition for the stability of the atom that the orbits of the various shells be interlocked, in a manner similar to that depicted for the K and L-orbits in Fig. 119,

doublets there are **irregular doublets**, which likewise follow a uniform characteristic law (and hence scarcely deserve their rather derogatory name).

We know the doublets ($a'a$) and ($\phi'\phi$), which we called M-doublets (cf. Table 12, p. 159, and p. 160) from the observations of the L-series; we gave them this name because they owe their origin to the differences of the M-levels. ($a'a$) denotes the difference (M_1M_2), ($\phi'\phi$) denotes the difference (M_3M_4), corresponding to the scheme, which we take from Table 12 :

$$\begin{array}{ll} \left. \begin{array}{l} (a' \dots M_2 \Rightarrow L \\ (a \dots M_1 \Rightarrow L \end{array} \right\} & \left. \begin{array}{l} (\phi' \dots M_1 \Rightarrow L_3 \\ (\phi \dots M_3 \Rightarrow L_3) \end{array} \right\} \end{array}$$

The M-shell corresponds to the quantum number (quantum sum) 3. From the general term-representation (6a) on page 477, we get for the three resolutions $3 + 0$, $2 + 1$, $1 + 2$, the three term-representations :

$$M_1 \dots (3, 0) = R \left(\frac{E}{e} \right)^2 \left[\frac{1}{3^2} + \frac{1}{4} \frac{a^2}{3^4} \left(\frac{E}{e} \right)^2 + \frac{1}{8} \frac{a^4}{3^6} \left(\frac{E}{e} \right)^4 + \frac{5}{64} \frac{a^6}{3^8} \left(\frac{E}{e} \right)^6 \right],$$

$$M_2, M_3 \dots (2, 1) = R \left(\frac{E}{e} \right)^2 \left[\frac{1}{3^2} + \frac{3}{4} \frac{a^2}{3^4} \left(\frac{E}{e} \right)^2 + \frac{29}{32} \frac{a^4}{3^6} \left(\frac{E}{e} \right)^4 + \frac{337}{256} \frac{a^6}{3^8} \left(\frac{E}{e} \right)^6 \right],$$

$$M_4, M_5 \dots (1, 2) = R \left(\frac{E}{e} \right)^2 \left[\frac{1}{3^2} + \frac{9}{4} \frac{a^2}{3^4} \left(\frac{E}{e} \right)^2 + \frac{77}{8} \frac{a^4}{3^6} \left(\frac{E}{e} \right)^4 + \frac{3349}{64} \frac{a^6}{3^8} \left(\frac{E}{e} \right)^6 \right].$$

From these the two term-differences follow :

$$\Delta\nu_1 = (2, 1) - (3, 0) \quad \text{and} \quad \Delta\nu_2 = (1, 2) - (2, 1),$$

namely,

$$\frac{\Delta\nu_1}{R} = \left(\frac{E}{e} \right)^4 \frac{a^2}{3^4} \left[\frac{1}{2} + \frac{25}{32} \frac{a^2}{3^2} \left(\frac{E}{e} \right)^2 + \frac{317}{256} \frac{a^4}{3^4} \left(\frac{E}{e} \right)^4 \right] \quad (11)$$

$$\frac{\Delta\nu_2}{R} = \left(\frac{E}{e} \right)^4 \frac{a^2}{3^4} \left[\frac{3}{2} + \frac{279}{32} \frac{a^2}{3^2} \left(\frac{E}{e} \right)^2 + \frac{13059}{256} \frac{a^4}{3^4} \left(\frac{E}{e} \right)^4 \right] \quad (12)$$

The ratio of these two—if we neglect the higher powers of a^2 , and if the values of E/e are equal in both formulæ—is equal to $1 : 3$, in agreement with eqn. (8a) on page 479. In this case we should have the hydrogen triplet with which we are already well acquainted. But the assumption that E/e is equal in each case no longer holds. *The hydrogen triplet resolves into two doublets of the hydrogen type.* As already hinted in the above representation of the terms M_2, M_3 , we must imagine the terms (2, 1) to be double. The one value represents the level M_2 , and has the same E/e as the term (3, 0), or the level M_1 , respectively; the other value belongs to the level M_3 , and has the same E/e as the term (1, 2) or the level M_4 , respectively. Accordingly, $\Delta\nu_1$ serves to represent ($a'a$) = (M_1M_2), and $\Delta\nu_2$ to represent ($\phi'\phi$) = (M_3M_4). For the rest, as we likewise indicated in the expression for the terms, the term (1, 2) is also to be regarded as double, namely, as the level M_4 and the level M_5 .

§ 5. Regular and Irregular Doublets of the X-ray Spectra 507

The calculation of ($a'a$) has been carried out by E. Hjalmar* on the basis of his own precision measurements. The question involved is to show that eqn. (11) gives us the same results as observation of (aa') for all values of Z , provided that a new "screen constant" s be chosen, where as in the case of the L-doublet, we have set

$$\frac{E}{e} = Z - s,$$

and have found the value of s empirically. The calculation is made after the model of eqns. (7) to (10) on page 500, the last of which is here

$$(Z - s)^2 = \left(\frac{3^2}{a} \frac{2\Delta\nu}{R} - \frac{22.5}{16} \frac{\Delta\nu}{R} \right) \left(1 + \frac{589}{1024} a^2 \frac{\Delta\nu}{R} \right) \quad (13)$$

For all elements between $Z = 41$ and $Z = 74$ we get the remarkably constant value

$$s = 13.0 \quad (13a)$$

and there is no indication of a systematic increase in the deviations. Thus we are justified in declaring the difference of level (M_1M_2) to be a regular doublet, and to apply the formula (11) by extrapolation in given cases to elements for which the doublet has not been observed. The same doublet-interval occurs, as we know (cf. p. 172) in the M-series between the lines $M\alpha$ and $M\beta$, or, more accurately, between $M\alpha'$ and $M\beta$.

In exactly the same way the eqn. (12) becomes assigned to the M-doublet ($\phi'\phi$) in the L-series. The fact that this doublet is essentially more widely separated than the doublet ($a'a$) in the L-series, corresponds at least qualitatively with the ratio 3 : 1 of the intervals of the components in the hydrogen triplet. On the basis of (12) it is also possible to calculate a screen number s from the observations of ($\phi'\phi$). The formula analogous to (13) is now

$$(Z - s)^2 = \left(\frac{3}{a} \sqrt{6} \cdot \frac{\Delta\nu}{R} - \frac{279}{16} \cdot \frac{\Delta\nu}{R} \right) \left(1 + \frac{191}{32} a^2 \frac{\Delta\nu}{R} \right) \quad (14)$$

and gives us

$$s = 3.3\ddagger \quad (14a)$$

Just as the M-shell belongs to the quantum-number 3, so does the N-shell to the quantum-number 4. Here there are four terms, after the model of hydrogen. How they are allocated to the four resolutions of the number 4, and to the various levels of the N-shell, is given by the following survey :

* Zeitschr. f. Phys., **3**, 262 (1920).

† Concerning the numerical data for the calculation of this screen number and of that of the N-doublet, cf. A. Sommerfeld and G. Wentzel, Zeitschr. f. Phys., **7**, 86 (1921).

$$\begin{aligned}
 N_1 \dots (1, 0) &= R \left(\frac{E}{e} \right)^2 \left[\frac{1}{1^2} + \frac{1}{4} \frac{a^2}{1^4} \left(\frac{E}{e} \right)^2 + \frac{1}{8} \cdot \frac{a^4}{4^6} \left(\frac{E}{e} \right)^4 + \frac{5}{64} \cdot \frac{a^6}{4^8} \left(\frac{E}{e} \right)^6 \right] \\
 N_2, N_3 \dots (3, 1) &= R \left(\frac{E}{e} \right)^2 \left[\frac{1}{1^2} + \frac{7}{12} \frac{a^2}{4^4} \left(\frac{E}{e} \right)^2 + \frac{119}{216} \cdot \frac{a^4}{4^6} \left(\frac{E}{e} \right)^4 + \frac{9767}{15552} \cdot \frac{a^6}{4^8} \left(\frac{E}{e} \right)^6 \right] \\
 N_4, N_5 \dots (2, 2) &= R \left(\frac{E}{e} \right)^2 \left[\frac{1}{4^2} + \frac{5}{4} \frac{a^2}{4^4} \left(\frac{E}{e} \right)^2 + \frac{21}{8} \cdot \frac{a^4}{4^6} \left(\frac{E}{e} \right)^4 + \frac{429}{64} \cdot \frac{a^6}{4^8} \left(\frac{E}{e} \right)^6 \right] \\
 N_6, N_7 \dots (1, 3) &= R \left(\frac{E}{e} \right)^2 \left[\frac{1}{4^2} + \frac{13}{4} \frac{a^2}{4^4} \left(\frac{E}{e} \right)^2 + \frac{181}{8} \cdot \frac{a^4}{4^6} \left(\frac{E}{e} \right)^4 + \frac{13373}{64} \cdot \frac{a^6}{4^8} \left(\frac{E}{e} \right)^6 \right]
 \end{aligned}$$

Three term-differences may be calculated from these levels. In the case of hydrogen they form the characteristic quartet, but here they occur as three distinct doublets, whether of N-levels or of lines in the L- or M-series. The ground for this is again the circumstance that the effective nuclear numbers E/e are, indeed, the same for the levels N_1N_2 , N_3N_4 , N_5N_6 , but different for the levels N_2N_3 , N_4N_5 , and N_6N_7 . We designate the three doublet intervals by $\Delta\nu_1$, $\Delta\nu_2$, $\Delta\nu_3$, and give their meaning, as well as the theoretical and the empirical means of calculating them in the following scheme:

$$\left. \begin{aligned}
 (N_1N_2) = M(a'a) = (3, 1) - (4, 0) \\
 R = \left(\frac{E}{e} \right)^2 \frac{a^2}{4^4} \left[\frac{1}{3} + \frac{23}{54} \cdot \frac{a^2}{4^2} \cdot \left(\frac{E}{e} \right)^2 + \frac{1069}{1944} \right] \\
 (N_3N_4) = L(\gamma'\gamma) = (2, 2) - (3, 1) \\
 \Delta\nu_2 = \left(\frac{E}{e} \right)^4 \frac{a^2}{4} \left[\frac{2}{3} + \frac{56}{27} \cdot \frac{a^2}{4^2} \cdot \left(\frac{E}{e} \right)^2 + \frac{5905}{972} \cdot \frac{a^4}{4^4} \left(\frac{E}{e} \right)^4 \right] \\
 (N_5N_6) = L(\chi\chi') = (1, 3) - (2, 2) \\
 \Delta\nu_3 = \left(\frac{E}{e} \right)^4 \frac{a^2}{4} \left[9 + 20 \cdot \frac{a^2}{4^2} \cdot \left(\frac{E}{e} \right)^2 + \frac{809}{4} \cdot \frac{a^4}{4^4} \left(\frac{E}{e} \right)^4 \right]
 \end{aligned} \right\} \quad (16)$$

Of these three doublets only the "N-doublet ($\chi\chi'$) of the L-series" (cf. p. 160) may be obtained to a sufficient extent from direct measurements of the line-intervals. The relativistic doublet-formula hereby again proves its truth. From a formula that is analogous to (13), (14), we get for the defect of the nuclear charge

$$s = 17 \quad \dots \quad (15a)$$

of course with less accuracy than previously, inasmuch as the weak and closely neighbouring lines a , a' can be measured with precision only in the case of few elements.

We are obliged by the circumstances to derive the remaining two N-doublets $M(a'a)$ and $L(\gamma'\gamma)$ indirectly from combinations of several line-intervals. According to formulæ (15) and (16) there correspond to the values of the doublet intervals so obtained the screen-constants*

$$s = 34 \quad \dots \quad (16a)$$

and

$$s = 25 \quad \dots \quad (17a) \text{ respectively.}$$

* The screen-constant of N_1N_2 exhibits a systematic decrease below $Z = 74$,

The growth of the screen constant s from 3.5 in the case of the L_1 -doublet to 25 and 34 in that of the N -doublet is quite satisfactory from the point of view of the model since it seems to point to an increase in the number of the electrons interposed. But this must not tempt us to believe that we may approach the process of screening, of the formation of doublets, and, indeed, of the constitution of the shells by means of elementary notions of models. At the very outset, the great difference in the screen-quantities within the same shell (17, 25, 34 with the N -shell) remains unintelligible on the model. The following remark which is directed against a too literal acceptance of our calculations on levels constitutes a still more serious objection. If we wished to apply our screen-constants s , determined from the doublets, to calculate the terms themselves, we should arrive at a totally inadequate agreement with experiment. The terms do, indeed, in a general way follow Moseley's relation, that is, apart from relativity corrections, they depend quadratically on the atomic number, but the screen-constant that is hereby involved is in each case to be chosen afresh, and differently then in the corresponding doublets. We take this into account by introducing in the principal member of the expansion (6a) on page 477 a screen constant (σ) different from that contained in the members giving the relativity corrections, and hence we write :

$$\frac{\nu}{R} = \left(\frac{Z - \sigma}{n + n'} \right)^2 + \left[\frac{1}{4} + \frac{n'}{n} \right] a^2 \left(\frac{Z - s}{n + n'} \right)^4 + \left[\frac{1}{8} + \frac{3n'}{4n} + \frac{3}{2} \left(\frac{n'}{n} \right)^2 + \frac{1}{4} \left(\frac{n'}{n} \right)^3 \right] a^4 \left(\frac{Z - s}{n + n'} \right)^6 + \dots \quad (6b)$$

In order that we may in each case get the above $\Delta\nu/R$ -values for the regular doublets by subtracting two formulæ of the type (6b), we have simply to give the constants σ as well as the constants s the same value for two levels of a regular doublet.

Finally, we get to the *irregular doublets*. The law governing them was only discovered as late as 1920 by C. Hertz in the dissertation quoted on page 186. Just as the difference of limits (L_1L_2) on the L_1 -doublet which is equal to it represents the type of the regular doublet, so the difference of limits (L_2L_3) measured by Hertz represents the type of the irregular doublet. The measurements of Hertz relate to the elements between Cs 55 and Nd 60, inclusively. They are represented in Fig. 120, in which also the differences of limits L_2L_3 of the elements from W (74) to U (92) measured by others have been included. This figure gives expression to the following law. *If, following Moseley, we plot $\sqrt{\nu}$ against Z , then the graphs for L_2 and L_3 run perceptibly parallel to each other, in direct contrast to the graphs for L_1 and L_2 , which diverge further and further from each other as Z increases, in accordance with the law of regular doublets.*

Thus the law of irregular doublets asserts that the difference of the $\sqrt{\nu}$ -values of both doublet components is approximately constant. Table 54 illustrates this for (L_2L_3). Here the first column gives the ν/R -values obtained from Table 22. The second column, with the heading $\sqrt{L_3} - \sqrt{L_2}$ contains the differences of the $\sqrt{\nu}/R$ -values for both levels. Within the region of observation of Hertz these differences are exactly constant and equal to 0.66; from then onwards they increase slowly and continuously to the value 0.76.

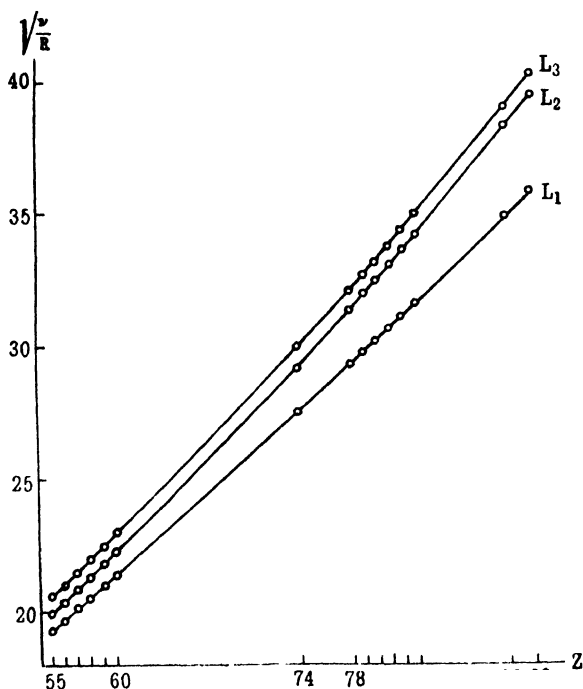

FIG. 120.

As Wentzel* shows, the same law, however, governs all those differences of level of the M- and N-shell, which we have not already recognised as regular doublets. Among the M-limits these are the doublets M_2M_3 and M_4M_5 ; among the N-limits, N_2N_3 , N_4N_5 , N_6N_7 . We shall show in a table in the next section how the ν/R -values have been obtained (they arise out of direct measurements only in the case of the M-limits, and, even then, only for a few elements. In spite of the fact that we are dealing with differences of quantities that are small, and that have been determined indirectly, the approximate constancy of the sequences of numbers is unmistakable.

* Dissertation, Munich, 1921. Cf. Zeitschr. f. Phys., 6, 84 (1921).

§ 5. Regular and Irregular Doublets of the X-ray Spectra 511

Hertz has already indicated, too, at least in broad outline, how we have to interpret the law of the irregular doublets from the view of the model. By expressing the wave-number ν of the individual limit approximately by a formula of Moseley's type, we get

$$\frac{\nu}{R} = \frac{1}{n^2} (Z - \sigma)^2, \quad \sqrt{\frac{\nu}{R}} = \frac{Z - \sigma}{n} \quad (18)$$

where n signifies the quantum sum for the shell in question, and σ the screen number now under consideration.

TABLE 54

	$L_{23}-L_{12}$	$\sqrt{L_{23}}-\sqrt{L_{12}}$	$\sqrt{M_3}-\sqrt{M_2}$	$\sqrt{M_5}-\sqrt{M_4}$	$\sqrt{N_3}-\sqrt{N_2}$	$\sqrt{N_5}-\sqrt{N_4}$	$\sqrt{N_7}-\sqrt{N_6}$
42 Mo . . .	—	—	1.2	—	—	—	—
45 Rh . . .	—	—	1.4	—	—	—	—
55 Cs . . .	26.1	0.66	1.18	—	—	—	—
56 Ba . . .	26.4	0.63	1.12	—	—	—	—
57 La . . .	27.9	0.64	1.16	—	—	—	—
58 Ce . . .	28.9	0.66	1.17	—	—	—	—
59 Pr . . .	29.9	0.66	1.18	—	—	—	—
60 Nd . . .	30.2	0.65	1.19	—	—	—	—
74 W . . .	40.3	0.69	1.20	0.66	2.7	1.28	0.64
78 Pt . . .	48.0	0.72	1.22	0.63	2.6	1.35	0.50
79 Au . . .	45.7	0.72	1.25	0.63	2.5	1.39	0.64
80 Hg . . .	45.9	0.70	—	—	—	—	—
81 Tl . . .	48.4	0.73	1.24	0.61	2.32	1.16	0.69
82 Pb . . .	47.4	0.72	1.23	0.63	2.33	1.36	0.69
83 Bi . . .	52.3	0.72	1.21	0.63	2.15	1.22	0.70
90 Th . . .	58.0	0.75	1.24	0.69	2.00	—	—
92 U . . .	63.1	0.76	1.26	0.69	2.08	1.23	0.48

Now it became manifest when we explained the regular doublets that the screen-number s which occurs in the members giving the relativity correction in formula (6b) always assumes different values for two levels like $(M_2M_{2s}), (N_2N_{2s})$ or (N_4N_{4s}) , which form irregular doublets with each other [cf. (13a), (14a), (15a), (16a), 17a)]. We shall now also let the same be true for the screen-constant σ that occurs in the principal member of the formula (6b), or, respectively, in formula (18), which expresses this principal member; the constant σ is also to have different values in the two levels of an irregular doublet. If we call the two values σ_1 and σ_2 , and take into account that n likewise has the same value n for two levels of the same shell, then we get Hertz's law from the second eqn. (18) in the form :

$$\Delta \sqrt{\frac{\nu}{R}} = \frac{\sigma_1 - \sigma_2}{n} \quad (19)$$

At the same time the following value for $\Delta\nu$ itself follows from the first eqn. (18):

$$\frac{\Delta\nu}{R} = \frac{2(\sigma_1 - \sigma_2)}{n^2} \left(\frac{1}{2} - \frac{\sigma_1 + \sigma_2}{2} \right) \quad (20)$$

Eqn. (20) allows us to set up the following comparison between regular and irregular doublets. *In the irregular doublets the difference $\Delta\nu$ of the wave-numbers increases linearly with the atomic number; in the regular doublets it increases with the fourth power. In the irregular doublets the difference of wave-length $\Delta\lambda$ decreases as the atomic number increases, and, indeed, it increases with the third power of the latter; in the regular doublets it is, as we know, perceptibly constant.*

Strictly speaking, the $\Delta\nu/R$ -values in Table 54 were not constant. At least in the case of the irregular doublets (L_1L_2) and (M_2M_3) they exhibited a small but systematic change. Here, as in the curvature of the graph lines in Figs. 51 and 53, we encounter an influence of the relativity members which we neglected in (18) and (19). For, on the basis of formula (6b), the law of irregular doublets may be defined more sharply by asserting that *in the irregular doublets the values $\Delta\sigma = \sigma_1 - \sigma_2$ are exactly constant, but the values $\Delta\nu$ are constant only to a first approximation.*

This more sharply defined form of Hertz's law is justified by numerical data in the dissertation quoted on page 507. It proves of particular value for the doublet (M_2M_3), in which all signs of a systematic change vanish when the relativity corrections provided for in eqn. (6b) have been introduced into the values of $\Delta\sigma$.

§ 6. General System of Röntgen Spectra.

Whereas in Chapter III. we presented only the general classification and the principal results of Röntgen spectroscopy, we here wish to discuss the finer questions of the theory. We arrange them under separate headings.

1. **The complete scheme of lines and levels.** Fig. 121, which anticipates the results of the systematic classification that follows, is to be regarded purely as a scheme. For example, within each shell the levels are drawn at equal distances, whereas in reality the differences of level are very great. The decrease in the differences of level in passing to the higher shells is in reality much greater than it is drawn in the figure. In the case of the heavier elements a (three-fold) P-shell would have to lie above the O-shell. Besides the K-, L-, and M-series drawn in the figure, we should also have to expect an N-series, but on account of its great softness, it has not yet been observed. Wherever, as happens particularly in the case of the M-series, arrows occur without letters, the lines in question are to be expected theoretically, but have not yet been discovered, on account of their too feeble intensity.

The scheme of Fig. 121 is built up as follows. The principal lines of the K-, L- and M-series are

$$K\alpha = L_1 \rightarrow K, \quad L\alpha = M_1 \rightarrow L_1, \quad M\alpha = N_1 \rightarrow M_1.$$

Since we know the K-limit from direct absorption measurements, by subtracting the measured wave-numbers from $K\alpha$, $L\alpha$, $M\alpha$, we get the highest or principal levels of the L-, M-, N-shell, namely, L, M, N (which have also in part been measured as absorption limits).

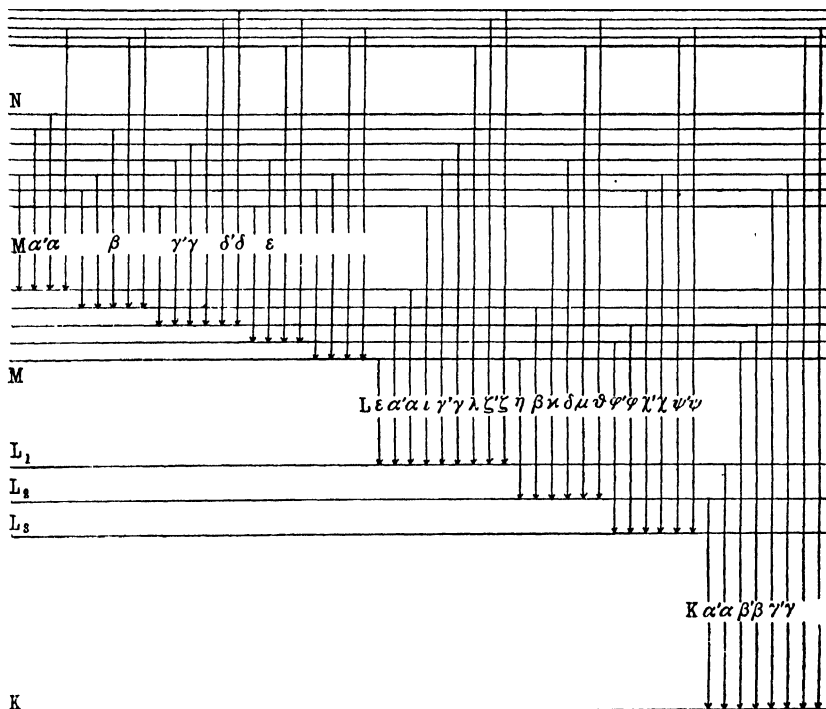

FIG. 121.

We get to the levels L_2, M_2, N_2 , by such lines as, for example,

$$K\alpha' = L_2 \rightarrow K, \quad L\alpha' = M_2 \rightarrow L_1, \quad M\alpha' = N_2 \rightarrow M_1,$$

or, more practically, by means of the doublet differences

$$K(a, a') = L_2 - L_1, \quad L(a, a') = M_2 - M_1, \quad M(a, a') = N_2 - N_1.$$

A test of the levels L_2, M_2, N_2 that are to be determined in this way is then furnished, for example, by the lines

$$L\beta = M_2 \rightarrow L_2, \quad M\beta = N_2 \rightarrow M_2.$$

If we then take the third L-limit L_3 from the absorption measurements, we get two further M-levels, namely, M_3 and M_4 , from the lines

$$L\phi = M_3 \rightarrow L_3, \quad L\phi' = M_4 \rightarrow L_3,$$

which, according to excitation measurements by Hoyt (cf. p. 180), actually have L_3 as their final level. A test is furnished by the line $K\beta$, which has been the centre of much controversy (cf. what is said below about combination defects), and its weak satellite $K\beta'$, measured by de Broglie.* For we have

$$K\beta = M_3 \rightarrow K, \quad K\beta' = M_4 \rightarrow K.$$

This interpretation of $K\beta$, $K\beta'$ holds true in the relations arising from combining the following terms, which may be read off from Fig. 121, and which were first set up by Smekal: †

$$K\beta = K\alpha + L\phi - (L_3 - L_1), \quad K\beta - K\beta' = L\phi - L\phi'.$$

We next get to the levels N_3N_4 by means of the lines $L\gamma$ and $L\delta$. For we have

$$L\gamma = N_3 \rightarrow L_1, \quad L\delta = N_4 \rightarrow L_2.$$

$L\gamma'$, the soft ‡ satellite of $L\gamma$, which has been measured only in the case of uranium, and which forms the exact L -doublet difference with $L\delta$, corresponds to the transition $N_4 \rightarrow L_1$, and gives us a first test of the difference of level N_3N_4 . A check on the position of N_3 is furnished by $M\gamma = N_3 \rightarrow M_3$ as a result of the relation §

$$M\gamma = L\gamma - L\phi + (L_3 - L_1).$$

A check on the position of N_4 is furnished by $M\epsilon = N_4 \rightarrow M_4$ as a result of the relation

$$M\epsilon = M\gamma + (L\phi - L\phi') - (L\gamma - L\gamma').$$

If we here leave out of account the small N-difference

$$L\gamma - L\gamma' = N_4 - N_3,$$

then, bearing in mind the origin of $K\beta$ and $K\beta'$, we get that

$$M\epsilon - M\gamma = L\phi - L\phi' = K\beta - K\beta',$$

that is, a doublet of each of the M-, L-, and K-series is equal to each of the others. Both of the following N-levels, N_5 and N_6 , are to be defined as initial levels of $L\chi$ and $L\chi'$. Their common final level is L_3 , according to the measurements of the excitation as measured by Hoyt, and hence they are represented by

$$L\chi = N_5 \rightarrow L_3, \quad L\chi' = N_6 \rightarrow L_3.$$

* Compt. rend., 170, 1053, 1245 (1920).

† Cf. Chapter III, § 6, page 164.

‡ Zeitschr. f. Phys., 5, 91 (1921).

§ Zeitschr. f. Phys. 5, 121 (1921).

N_5 is at the same time the initial level of $K\gamma$. Hence the combination equation that is to be regarded as the test of the position of N_5 becomes

$$K\gamma = Ka + L\chi - (L_3 - L_1).$$

There still remain the lowest M- and N-levels, M_5 and N_7 , and the initial levels of $L\epsilon$, $L\eta$, and $L\iota$, $K\kappa$. As our line-diagram shows, we interpret the latter thus :

$$\begin{array}{ll} L\epsilon = M_5 \rightarrow L_1, & L\eta = M_5 \rightarrow L_2, \\ L\iota = N_7 \rightarrow L_1, & L\kappa = N_7 \rightarrow L_2. \end{array}$$

Of the L-lines that were drawn up in the table in Chapter III, only $L\xi$, θ , ψ now remain to be interpreted. These have their origin in a shell which is still further out than the N-shell, and which we called the O-shell. The same is true of two further L-lines $L\lambda$, $L\mu$, that are necessary according to theory, and of which the softer line $L\lambda$ of Dauvillier* has been established beyond dispute. It becomes possible to allocate the lines mentioned to definite O-levels only on the basis of the principles of selection that are to be discussed under No. 4.† It has to be assumed that the lines ζ and ψ are in reality doublets ($\zeta'\zeta$) and ($\psi'\psi$), of which the components are inseparably close. The transitions from the O-shell into the L-shell then appear to be fully analogous to the transitions from the M- and the N-shell to the L-shell, as is immediately clear from the following survey :

$$\begin{cases} L\alpha = M_1 \rightarrow L_1, L\alpha' = M_2 \rightarrow L_1, L\beta = M_2 \rightarrow L_2; \\ L\phi = M_3 \rightarrow L_3, L\phi' = M_4 \rightarrow L_3; L\epsilon = M_5 \rightarrow L_1, L\eta = M_5 \rightarrow L_2. \\ L\gamma = N_3 \rightarrow L_1, L\gamma' = N_4 \rightarrow L_1, L\delta = N_4 \rightarrow L_2; \\ L\chi = N_5 \rightarrow L_3, L\chi' = N_6 \rightarrow L_3; L\iota = N_7 \rightarrow L_1, L\kappa = N_7 \rightarrow L_2. \\ L\zeta = O_1 \rightarrow L_1, L\zeta' = O_2 \rightarrow L_1, L\theta = O_2 \rightarrow L_2; \\ L\psi = O_3 \rightarrow L_3, L\psi' = O_4 \rightarrow L_3; L\lambda = O_5 \rightarrow L_1, L\mu = O_5 \rightarrow L_2. \end{cases}$$

Finally, of the M-lines all those that were noted in Chapter III have been arranged into our scheme except $M\delta$. The interpretation of this line given in Table 17, page 173, is made more precise by our Fig. 121 in the following way :

$$M\delta = O_1 \rightarrow M_3$$

corresponding to the combination ‡

$$M\delta - M\gamma = L\zeta - L\gamma.$$

$M\delta$, too, has presumably a very close soft neighbouring satellite :

$$M\delta' = O_2 \rightarrow M_3.$$

This concludes our account of the line-scheme. It was first set up by Smekal (*loc. cit.*) and Coster,§ the latter of whom has firmly established

* Compt. rend., 173, 647 (1921).

† Cf. G. Wentzel, Zeitschr. f. Phys., 8, 85 (1921). The P-levels are also discussed in it.

‡ G. Wentzel, *ibid.*, 6, 84 (1921).

§ *Ibid.*, 5, 139 (1921).

the empirical foundations of the scheme by his precision measurements of the L-series of the heavier elements. In our account we have included several combination bonds, which are in a certain sense inner supports of the scheme.

2. Table of Term Values. The object of optical spectroscopy is not the lines, but the atomic states, the *terms*. They are all that need to be tabulated; the lines may be obtained as combinations of them (cf. p. 322).

The same holds for the Röntgen spectra. Here we have the advantage that individual terms may be directly measured as absorption limits; this can never be done sufficiently accurately in the case of the series limits in the visible. Further, we have the advantage that the number of terms is small, and that the complete table of terms of all the elements can be written down on two pages. For there are only (if we disregard the P-levels) $1 + 3 + 5 + 7 + 5 = 21$ limits, that is only 21.92 term values for the whole 92 elements. These term values are fixed characteristic numbers of the atom, and denote the energy that is required to lift an electron out of the shell in question into the outer region of the atom. The terms are hereby defined uniquely. They would become ambiguous only if the various quantum-states of the outer shells were developed in different atoms, and this is what we had to reject in the preceding paragraph (p. 504).

In drawing up Table 55 we are naturally most concerned about the question of accuracy. In general, the accuracy with which the position of the emission lines can be determined is greater than that of the absorption edges. Further, the absolute accuracy of the softer lines and edges is greater than that of the harder lines for the same relative error. The absolute errors become added in the term values. It is, therefore, expedient to start from the softest possible absorption limits in calculating their values. This is illustrated by Table 56. We there give the name "normal levels" (cf. the lowest row) to those lowest measured limits from which the harder limits may be obtained with the smallest absolute error by adducing line measurements. It is for this reason that, in the case of the heaviest elements, the L-limits are not taken from the direct measurements, but are referred to the M-limits, as is indicated in Table 56. Our knowledge of the K-limits would also be deepened in the same way if the K emission-lines were accurately known similarly by referring them to the L- or the M-limits. Unfortunately, so far this is only the case for molybdenum, rhodium, and tungsten, so that as far as the K-terms are concerned, we are compelled to fall back directly on the absorption measurements. The numbers given in the table denote wave-numbers expressed in units of the Rydberg number (ν/R -values). The accuracy of the calculated terms is determined, on account of the greater accuracy of the emission lines, essentially by the accuracy of the absorption limit that has been used as a basis in the calculation. That is why the terms themselves are less exact than the term combinations from

TABLE 55

Z	K	L ₁	L ₂	L ₃	M ₁	M ₂	M ₃	M ₄	M ₅	N ₁	N ₂	N ₃	N ₄	N ₅	N ₆	N ₇	O ₁	O ₂	O ₃	O _{3'}	O ₄	O ₅	
12	95·81	3·46					0·2																
13	114·67	5·13					(-0·1)																
15	158·26	9·89					0·7																
16	181·81	11·82					0·3																
17	207·84	14·72	14·85				0·5																
19	265·83	21·27	21·50				0·9																
20	297·48	25·61	25·87				1·9							0·4									
21	331·17	29·35	30·29				2·6							0·0									
22	365·43	33·1	33·5				2·2							0·0									
23	402·27	37·5	38·1				2·5							0·0									
24	441·14	42·36	43·08				3·3							0·0									
26	523·84	52·26	53·29				4·3																
27	568·90	58·45	59·67				5·4																
28	612·00	61·27	62·58				3·1																
29	661·06	68·31	69·80				4·9																
31	765·64	84·50	86·41				10·0																
42	1474·5	187·1	194·8		18·2	18·4	30·6						1·4	4·0									
45	1709·7	220·9	231·2		22·3	22·6	38·6						(-0·3)	3·8									
55	2626	370·6	396·2	422·5	54·8	55·9	75·0	79·9				7·1	7·2										
56	2756	388·1	415·8	441·7	59·0	60·2	78·8	84·3				8·3	8·3										
57	2858	405·0	435·0	462·3	62·3	63·5	83·4	89·4				8·5	8·6										
58	2970	423·3	454·7	482·9	65·7	67·0	87·5	94·3				8·7	8·9										
59	3093	440·0	475·0	504·0	69·2	70·7	91·9	99·7				9·0	9·2										
60	3214	457·5	495·4	524·9	72·2	73·9	95·9	103·3				8·7	9·0										
74	5118	750·88	849·42	889·9	132·43	137·03	166·7	188·2	206·56	1·7	1·9	17·12	17·61	30·0	35·0	42·9	0	2					
78	5764	851·26	977·18	1023·9	155·68	161·53	194·1	223·4	242·62	4·5	4·7	22·46	23·41	38·4	44·8	51·7	0	5				5	
79	5941	877·65	1011·45	1058·9	162·12	168·43	202·4	233·7	252·02	5·5	5·7	24·19	25·62	41·5	47·8	57·1	0	7				6	
80	6112	905·20	1047	1093																			
81	6293	932·15	1082·64	1131·0	175·73	182·76	217·8	252·4	272·3	8·52	8·60	27·99	29·52	43·5	52·2	62·7	1	6					
82	6468	959·53	1119·55	1168·2	182·02	189·57	224·9	261·2	281·78	9·27	9·65	29·55	31·18	48·2	54·5	65·0	0	5					
83	6642	988·79	1158·52	1207·8	190·25	198·59	234·0	273·6	294·72	11·82	12·59	32·51	34·42	50·3	58·6	69·8	1	11					
90	8057	1200·7	1451·5	1509·7	244·30	255·55	297·99	354·7	381·5	24·20	24·87	48·77	51·6				6·6					22·8	
92	8477	1264·3	1543·1	1603·5	261·03	273·99	317·18	380·9	403·4	27·45	28·24	54·67	57·0	77·1	96·8	105·6	7·6	15·4					

TABLE 56

	Z = 90 and 92	Z = 74 to 83	Z = 55 to 60	Z = 42 and 45	Z = 12 to 31	
K	Tab. 21	Tab. 21	Tab. 21	Tab. 21	Tab. 21	
L ₁	M ₁ + L α	Tab. 22	Tab. 22	K - K α	K - K α	
L ₂	M ₂ + L β	L ₁ + (L β - L α')	L ₁ + (L β - L α')	K - K α'	K - K α'	
L ₃	M ₃ + L ϕ	L ₁ + L ϕ + M γ - L γ *	Table 22	---	---	
M ₁	} Tab. 23	L ₁ - L α	L ₁ - L α	K - K α - L α	M ₁	
M ₂		L ₁ - L α'	L ₁ - L α'	K - K α - L α'	M ₂	
M ₃		L ₁ + M γ - L γ	L ₁ + M γ - L γ	L ₃ - L ϕ	K - K β	M ₃
M ₄		(L ₁ + M γ - L γ) + (L ϕ - L ϕ')*	L ₁ - L ϵ †	L ₃ - L ϕ'	---	M ₄
M ₅		M ₃ + (L ϕ - L ϕ')	---	---	---	M ₅
N ₁	M ₁ - M α	L ₁ - L α - M α	---	---	N ₁	
N ₂	M ₂ - M β	L ₁ - L α' - M β	---	---	N ₂	
N ₃	M ₃ - M γ	L ₁ - L γ	---	---	N ₃	
N ₄	M ₃ + (L ϕ - L ϕ') - M ϵ	L ₁ + (L β - L $\alpha')$ - L δ	L ₁ - L γ	---	N ₄	
N ₅	M ₃ + L ϕ - L χ *	L ₁ + L ϕ + M γ - L γ - L χ *	L ₁ + (L β - L $\alpha')$ - L δ	K - K α - L δ	N ₅	
N ₆	M ₃ + L ϕ - L χ' *	(L ₁ + L ϕ + M γ - L γ) - L χ' *	---	K - K γ	N ₆	
N ₇	M ₁ + L α - L ϵ	(L ₁ + L ϕ + M γ - L γ) - L χ *	---	---	N ₇	
O ₁ , O ₂	M ₃ - M δ	L ₁ - L ζ	---	---	O ₁ , O ₂	
O ₃ , O ₄	M ₃ + L ϕ - L ψ	(L ₁ + L ϕ + M γ - L γ) - L ψ *	---	---	O ₃ , O ₄	
O ₅	M ₁ + L α - L λ	L ₁ - L λ	---	---	O ₅	
Normal levels	M ₁ , M ₂ , M ₃	L ₁	L ₁ , L ₃	K	K	
					Normal levels	

* L ϕ has not been measured for Z = 79 (Au). Here the expression L₁ + L ϕ + M γ - L γ was replaced by the limiting frequency L₃. In the same way in the case of Z = 80 (Hg), L₂ and L₃, have been taken from absorption measurements.
 † In the case of Tl, 81 ϵ has not been measured. L ϵ was replaced by L - (L β - L α').

which the absorption limit cancels out in given cases. For this reason also it is important to use a fixed *normal level* for each element. The accuracy of the term-combinations with which we are in practice concerned then becomes independent of the exact value of this normal level, and equal to the accuracy of the emission lines involved.

At the same time, the table of term values illustrates how we arrived at Table 54 of the irregular doublets in the preceding paragraph. It is only necessary to take the square roots of the term-values in question, for example, M_2, M_3 . The difference between the roots of these two has been noted in Table 54.

The gaps in our Table 55 of terms is due to the fact that in certain regions, for example, between the atomic numbers 45 and 55, precision measurements of the K-lines and the L-limits are still wanting. Future measurements will have to be inserted at just the edges of these gaps, or at points where more accuracy is desirable in the table of terms. Since the frequency-difference between an absorption edge (for example, L_1), and a corresponding emission line (for example, $L\zeta = O_1 \rightarrow L_1$) just represents the frequency of the initial level (O_1) of the line in question, a systematic investigation of the relative position of absorption edges and emission lines* (on one and the same plate) seems highly desirable. And it would denote a very important step forward if we should succeed in fixing the N-limits directly by more optical methods than those hitherto used. For then we should be able to place our normal levels higher, and to give greater precision to all the lower M-, L-, and K-levels.

3. Regularities in the Scheme of Levels. The calculations of the preceding section have furnished us with a sure foundation on which we can build up further conclusions on the character of the various levels. We saw there that in each shell regular and irregular doublets alternate according to the following scheme :

$$K \mid \overbrace{U_1 U_2 U_3} \mid \overbrace{M_1 M_2 M_3 M_4 M_5} \mid \overbrace{N_1 N_2 N_3 N_4 N_5 N_6 N_7} \mid \overbrace{O_1 O_2 O_3 O_4 O_5}.$$

The upper bracketings denote *regular doublets*, the lower ones *irregular doublets*; both are characterised as functions of the atomic number by a definite analytical law which contains only one empirical parameter, namely, the screen number in the case of regular doublets and the difference of two screen numbers in Hertz's law for the irregular doublets.†

If, besides this, we bear in mind the wonderful regularity that exists in the sequence of the numbers giving the sub-divisions of the levels, namely, 1 K-level, 3 L-levels, 5 M-levels, 7 N-levels, and in the sequence

* Cf. Dauvillier, *Compt. rend.*, **172**, 1350 (1921).

† It is hardly to be doubted that the conditions in the O-doublets correspond exactly to those in the L-, M-, N-doublets. At any rate we see from Table 55 that (O_2, O_3) and (O_4, O_5) have the character of irregular doublets. Cf. *Zeitschr. für Phys.*, **8**, 85 (1921).

of the quantum numbers (or, more correctly, in the quantum sums $n + n'$), namely, 1 in the K-shell, 2 in the L-shell, 3 in the M-shell, we must admit that in spite of the manifold conditions reigning there is beautiful order and design in the interior of the atom. Even if we cannot calculate the levels themselves accurately by theory, but must for the present derive them from observation, yet we are fully clear about the significance of the levels and their mutual arrangement. The state of affairs is not a jot less favourable than in the case of the visible spectra, in which we are also very far from predicting the terms by theory but have succeeded in classifying them perfectly.

Concerning the magnitude of the terms, in particular, the universal law holds that they decrease in the transition from the one shell to another when the quantum-number $n + n'$ increases, and they also decrease within each shell when the azimuthal quantum-number n decreases.

The allocation of the azimuthal quantum-number n and of the "radial" quantum-number n' that occurs in our doublet calculations to the individual levels are given in the two highest rows of the following table in accordance with the data of the preceding section:

TABLE 57

	K	L ₁ L ₂ L ₃	M ₁ M ₂ M ₃ M ₄ M ₅	N ₁ N ₂ N ₃ N ₄ N ₅ N ₆ N ₇	O ₁ O ₂ O ₃ O ₄ O ₅
n	1	2 1 1	3 2 2 1 1	4 3 3 2 2 1 1	3 2 2 1 1
n'	0	0 1 1	0 1 1 2 2	0 1 1 2 2 3 3	2 3 3 4 4
k	1	2 2 2	3 3 3 3 3	4 4 4 4 4 4 4	5 5 5 5 5
m	1	2 2 1	3 3 2 2 1	4 4 3 3 2 2 1	3 3 2 2 1

The third column states that the quantum sum $k = n + n'$ is constant in each shell (this implies nothing new for the inner shells), and that it increases continuously in the series K, L, M, N, O. In the case of the O-levels the latter postulate gives a first definition of the radial quantum-number n' .

But a new and fundamental step for what follows is contained in the fourth row. For each level we here define a third quantum-number m , which, linking up with the visible spectra, we should best like to call "inner quantum-number," but which, owing to the fact that it is not actually quite analogous to the inner quantum-number defined earlier, we prefer to indicate by the more non-committal name "**ground quantum-number.**" The ground quantum-number has been introduced in such a way that it has the same value for each two levels that have been combined into an irregular doublet. $m - n$ is accordingly always equal to zero or 1. It is only now after we have introduced the third quantum-number m that we are enabled to bring the levels finally into order and to predict the transitions between the levels.

Something new is likewise contained in the last columns of Table 57. They state that the azimuthal quantum-number n and the ground quantum-number m do not in the O-shell exceed the number 3. This statement is very closely related to general views of Bohr (p. 109). Starting from our point of view we are led on to them by considerations about the following class.

4. Principle of Selection. We evolve the rules relating to this principle in two stages.

(a) We imagine the *irregular doublets* contracted to zero width by making, say, the difference of the screen numbers σ that occur in Hertz's law vanish. The number of the L-, M-, and N-levels then becomes reduced to 2, 3, 4 respectively, and then we get the same conditions among them as we should expect for Röntgen spectra that are fully of the hydrogen type. Here Fig. 121 degenerates* into Fig. 121 a. The

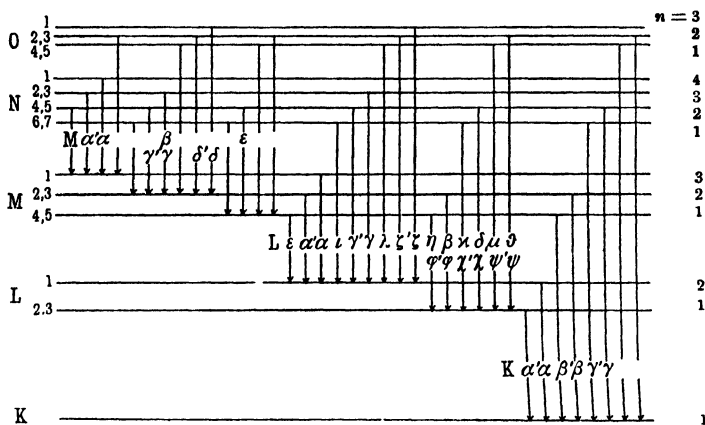

FIG. 121 a.

ground quantum-number m vanishes out of the scheme of levels and the azimuthal quantum-number n alone becomes the decisive factor for possibilities of combination. For all lines that actually occur it fulfils the rule of selection :

$$n \rightarrow n - 1 \text{ (strong), } \quad n \rightarrow n, \quad \text{and } n \rightarrow n + 1 \text{ (weak)} \quad . \quad (1)$$

The symbols written alongside the arrows in Fig. 121 a indicate that the lines allowed by this rule have all actually been observed, but also that several of the observed lines would belong to the same transitions.

(b) We then suppose the *regular doublets* contracted to zero but imagine the relativity members to be eliminated by the assumption $\alpha = 0$. Here again the numbers of the L-, M-, and N-levels amount to 2, 3, 4 respectively. They are numbered by the ground quantum-number

* Fig. 121 a is identical with the scheme of levels which the author used in his first attempt to apply the idea of fine-structure to the M- and the N-shell. Cf. Zeitschr. f. Phys., 1, 135 (1920).

We have exceptions to it only in the case of several particularly weak lines which can be made visible photographically only by extremely long exposure; they were not noted in Fig. 121. To them there belongs the interesting line $Ka_3 = L_3 \rightarrow K$, which, in the case of W, has been separated by Duane and Stenström in the third and fourth order from the closely neighbouring line $Ka' = L_2 \rightarrow K$ by means of the ionisation method. We know from p. 274 that the rules of selection are broken in strong external fields. It suggests itself to us to trace the lines mentioned back to the action of strong inner atomic fields. Indeed, we may surmise that it will in general be possible by means of long exposures to obtain indications of lines that are otherwise forbidden.

5. Combination Defects. As early as 1913 Kossel* called attention to the "addition relations" that may be read off from the oldest and simplest line-scheme (cf. Figs. 47 and 48):

$$K\beta = Ka + La, \quad L\gamma = La + Ma \quad . \quad . \quad . \quad (1)$$

and Bohr remarked† in 1914 that these addition relations are nothing other than applications of Ritz's Principle of Combination. The author‡ endeavoured in 1916 to ascertain whether they were exactly correct in this form and found that the answer was in the negative. Accordingly, in the first German edition of this book the "combination defects"

$$\Delta_1 = Ka + La - K\beta, \quad \Delta_2 = La + Ma - L\gamma \quad . \quad . \quad (2)$$

were examined with regard to their dependence on the atomic number, and were represented graphically. The name chosen indicates that the presence of these differences was originally regarded as a transgression against the principle of combination. In contrast to this, Kossel§ and, independently of him, Duane and Stenström|| expressed the conviction that the combination defects are caused by sub-divisions of the M- and N-shell and are compatible with the combination principle. It was concluded from a comparison of the line- and absorption-measurements that $K\beta$ arises through the transition $M_3 \rightarrow K$. On the other hand the author,¶ starting from the fact that the Röntgen spectra have a hydrogen character and following the lines of argument of Fig. 121 a, considered himself compelled to ascribe to $K\beta$ the origin $M_2 \rightarrow K$, corresponding to the transition $2 \rightarrow 1$ of the azimuthal quantum-number, and likewise to $L\gamma$ the origin $N_2 \rightarrow L_1$, corresponding to $3 \rightarrow 2$. In place of (1) we should then require

$$K\beta = Ka' + L\beta, \quad L\gamma = La' + M\beta \quad . \quad . \quad (3)$$

and still the differences (2) are only slightly diminished and are by no means zero. In particular, in the case of the $L\gamma$'s of the metals U and

* Verh. d. D. Phys. Ges., **16**, 953 (1914).

† Phil. Mag., **30**, 394 (1915).

‡ Ann. d. Phys., **51**, 125 (1916). Concluding remark.

§ Zeitschr. f. Phys., **1**, 119 (1920).

|| Proc. Nat. Acad., **6**, 477 (1920).

¶ Zeitschr. f. Phys., **1**, 135 (1920).

They amount to about 25, measured in ν/R -units, and lie far above the limits of error of present-day precision measurements. In Kossel's view the differences Δ_1 and Δ_2 defined by (4) represent the differences of level $M_3 - M_2$ and $N_3 - N_2$. The author previously regarded their linear advance with the atomic number, as represented in earlier editions of this book, as a difficulty for Kossel's explanation of the combination defects, because at that time only the law of regular doublets, which depend not linearly but bi-quadratically on the atomic number, was known. We now recognise this linear relation as Hertz's law of irregular doublets and, conversely, confirm this by the behaviour of the quantities Δ_1 and Δ_2 . These quantities no longer denote "combination defects," but each signifies a difference of level of an irregular doublet.

It is at once clear that *combination equations of the type (1) or (3) are impossible between three lines that obey the principle of selection* but rather that a remainder Δ must be left over, which has the significance of a difference of levels. For if a line (for example, $K\alpha$) corresponds to a transition from one level II to another, I, and a second line (for example, $L\alpha$) to the transition from III to II, then, according to our principle of selection II and I, as also III and II, must differ by ± 1 in the ground-quantum m , and hence III and I must differ by 0 or ± 2 . The transition III to I is therefore forbidden by the principle of selection and cannot be represented by a line ($K\beta$ in our example). If, on the other hand, IV be a level immediately neighbouring to III, which may therefore form a combination with I, then, it necessarily differs from III by 1 in the ground-quantum. We may call (III, IV) a combination defect, corresponding to the equation

$$(IV - III) = (I - II) + (II - III) - (I - IV).$$

The difference of 1 in the ground-quantum of III and IV is in agreement with the criterion for the irregular doublets in Table 57.

In the same way we may reason out that an irregular doublet can never be calculated by combining 2 (or in general an even number of) line-frequencies, and this leads us to understand why the irregular doublets, in contradistinction to the regular doublet, cannot appear directly as line-intervals in the spectrum. A line such as

$$K\alpha_3 = L_3 \rightarrow K (m \rightarrow m - 2),$$

which contradicts the principle of selection is of course to be excluded in applying this law. Just because it contradicts the principle of selection it may form the irregular doublet (L_2L_3) with $K\alpha' = L_2 \rightarrow K$. In general, the following law holds (if we exclude such lines as contradict the principle of selection in this way): *the differences of the regular doublets arise through combinations of an even number of lines, those of irregular doublets through combinations of an odd number of lines.*

In our systematic scheme of Röntgen spectra we have left out of

consideration such lines as do not allow themselves to be brought into our scheme of levels at all. In the case of the heavy elements these lines are all very weak; the strongest is a hard satellite of $L\gamma$ that was discovered by Dauvillier. In the case of the light elements they are certain lines, measured by Siegbahn, Hjalmar, and Stensson, which are denoted by $Ka_3, a_4, a_5, a_6, K\beta', \beta_3, La_3$. According to Wentzel these lines are to some extent to be interpreted as spark lines in the Röntgen spectrum, namely as emissions of an atom that is *multiply* ionised in the K-, L- . . . shell.

Recapitulating, we may say that the systematisation of the Röntgen spectra here effected is extremely satisfactory and surprising; so much the more surprising as it is not evolved from special quantitative ideas and such as are based on models but on general postulates of qualitative relationships and inner symmetry.

§ 7. Universal Spectroscopic Units. Spectroscopic Confirmation of the Theory of Relativity

In our theory of the fine structure there is a confluence of the three main currents of modern research in theoretical physics, namely, the theory of electrons, the theory of quanta, and the theory of relativity. This is exhibited in a particularly vivid way in the way our **fine-structure constant** α is built up:

$$\alpha = \frac{2\pi e^2}{hc} \dots \dots \dots (1)$$

Here e is the representative of the theory of electrons, h is the worthy representative of the quantum theory and c comes from the theory of relativity and, indeed, characterises it in comparison with the classical theory. If we also wish to interpret the numerical factor 2π in our formula, then it may serve to remind us of a fourth source from which we have continually drawn in our development, namely, mathematical analysis, which we have used copiously and which was indispensable for the unravelling of the fine structures.

We take the value of α spectroscopically out of the measurement of the hydrogen doublet (or better, out of the indirect measurement of the He^+ -lines, since the direct measurement is inexact, cf. p. 483). The relationship between α and $\Delta\nu_{II}$ is, by eqn. (1), § 4:

$$\Delta\nu_{II} = R\alpha^2/2^4 \dots \dots \dots (2)$$

and this, in conjunction with Paschen's value $\Delta\nu_{II} = 0.3645 \text{ cm}^{-1}$, cf. eqn. (2) in § 4, gives

$$\alpha^2 = 5.315 \cdot 10^{-5}, \quad \alpha = 7.290 \cdot 10^{-3} \dots \dots \dots (3)$$

We are now in a position to bring to a conclusion the idea of *spectroscopic units* which was taken up as early as page 217 and was

Inserting the values given in (3), (7), and (8) we get

$$e = \frac{5.315 \cdot 7.290 \cdot 3 \cdot 10^2}{4\pi \cdot 1.0974 \cdot 1.769 \cdot 10^{12}} = 4.766 \cdot 10^{-10} \quad (11)$$

We now need only once again refer back to eqn. (6) to get the value of h , too, namely

$$h = \frac{2\pi e^2}{ac} = 6.526 \cdot 10^{-27} \quad (12)$$

But we must also add the limits of accuracy of these determinations. These are given merely by the inaccuracy in the determination of $\Delta\nu_H$ and of the consequent inaccuracy in a , since the value of R_∞ in eqn. (8) may be regarded as absolutely exact for our purpose, and the value of e/m_0 in eqn. (7) may also be looked on as being sufficiently well known. The percentage accuracy of Paschen's value of $\Delta\nu_H$, by eqn. (2) in § 3, amounts to

$$\pm \frac{45}{3645} = \pm \frac{1}{81}$$

The percentage accuracy of a^2 is just as great; hence that of a^3 and e [see eqn. (10)] is:

$$\pm 2 \cdot \frac{1}{81} = \pm \frac{1}{54}$$

Hence we get as the limits of accuracy of e :

$$e = 4.766 \left(1 \pm \frac{1}{54} \right) \cdot 10^{-10} = (4.766 \pm 0.088) \cdot 10^{-10}$$

From this it follows from (12) that

$$h = 6.526 \left(1 \pm \frac{5}{6} \cdot \frac{1}{27} \right) 10^{-27} = (6.526 \pm 0.200) \cdot 10^{-27}$$

These limits of accuracy are, particularly in the case of h , unsatisfactorily wide. If, then, Paschen has not under-estimated the accuracy of his measurement of $\Delta\nu_H$, the idea of purely spectroscopic units must for the present remain an intention that can be put into effect only when the measurements of fine-structure have been made with greater certainty.

On the other hand we may follow L. Flamm* and calculate semi-spectroscopic units of very great trustworthiness. We do best by enlisting the aid of Millikan's measurement of e (cf. Chap. I, p. 15):

$$e = (4.774 \pm 0.004) 10^{-10} \quad (13)$$

and, retaining the spectroscopic value (7) for e/m_0 , then determine h spectroscopically by eqns. (8) and (9) with the greatest accuracy, namely:

$$h = \sqrt[3]{\frac{2\pi^2 e^5}{R_\infty c (e/m_0)}} = (6.545 \pm 0.009) 10^{-27} \quad (14)$$

* Physikal Zeitschr., 18, 515 (1917).

We venture to suggest that this is at present the truest value of the quantum of action. From (13) and (14) we now get for the best values of our fine-structure constants and of the hydrogen doublet:

$$\left. \begin{aligned} a &= (7.295 \pm 0.005)10^{-3}, & a^2 &= (5.322 \pm 0.007) \cdot 10^{-5} \\ \Delta\nu_{\text{H}} &= 0.3650 \pm 0.0005 \end{aligned} \right\} . \quad (15)$$

The value of $\Delta\nu_{\text{H}}$ so found agrees almost exactly with that given by Paschen, namely 0.3645, but has a much smaller possible error. R. T. Birge (cf. p. 487) uses the value $5.308 \cdot 10^{-5}$ for a^2 . We based our calculations in § 5 on the arithmetic mean of this value and that of eqn. (15); the value obtained was $a^2 = 5.315 \cdot 10^{-5}$. The value (14) for h coincides with the value $h = 6.55 \cdot 10^{-27}$ originally obtained by Planck from questions of heat radiation. Together with e and e/m_0 the values (which we have often used and quoted earlier) of m_0 , m_{H} and $L = 1/m_{\text{H}}$ become known at the same time:

$$\left. \begin{aligned} m_0 &= 8.998 \pm 0.01, & m_{\text{H}} &= (1.649 \pm 0.002) \cdot 10^{-24} \\ L &= (6.064 \pm 0.006) \cdot 10^{23} \end{aligned} \right\} . \quad (15a)$$

Finally, we revert once again to the beginning of this chapter, in particular to the law by which the mass of the electron (and, indeed, mass of any kind, depends on the velocity. According to the theory of relativity this law is expressed by:

$$m = \frac{m_0}{\sqrt{1 - \beta^2}} = m_0(1 + \frac{1}{2}\beta^2 + \dots) \quad . \quad (16)$$

On the other hand the older "absolute" theory, which assumed an absolute space or ether and postulated a spherical electron, asserts that the law of variability* of mass is:

$$m = \frac{3}{4}m_0 \frac{1}{\beta^2} \left(\frac{1 + \beta^2}{2\beta} \log \frac{1 + \beta}{1 - \beta} - 1 \right) = m_0 \left(1 + \frac{2}{5}\beta^2 + \dots \right) \quad (16a)$$

The decision as to which of these two formulæ is true is, as we emphasised on page 464, the *experimentum crucis* for the truth of the theory of relativity.†

Connected with the law of variability of mass is the law by which the kinetic energy depends on the velocity. We have, as we know, from the theory of relativity:

$$\left. \begin{aligned} E_{kin} &= (m - m_0)c^2 = m_0c^2 \left(\frac{1}{\sqrt{1 - \beta^2}} - 1 \right) \\ &= \frac{m_0c^2\beta^2}{2} \left(1 + \frac{3}{4}\beta^2 + \dots \right) \end{aligned} \right\} . \quad (17)$$

* First derived by M. Abraham, cf. his *Theorie der Elektrizität*, II, 3rd ed., pp. 162 and 175.

† The idea of this criterion was first communicated to the author by W. Lenz. K. Glüscher has carried it into effect in his Dissertation at Munich, 1917; cf. also *Ann. d. Phys.*, **52**, 608 (1917).

On the other hand, the absolute theory asserts* that

$$E_{kin} = \frac{3}{4} m_0 c^2 \left(\frac{1}{\beta} \log \frac{1 + \beta}{1 - \beta} - 2 \right) = \frac{m_0 c^2 \beta^2}{2} \left(1 + \frac{3}{5} \beta^2 + \dots \right) \quad (17a)$$

We have now to treat Kepler's problem of elliptic motion for an atom of the hydrogen type on the view of the absolute theory, and from it to calculate the fine-structure of spectral lines. Firstly the law of areas which is independent of the law of variability of mass also holds here. It is Kepler's second law which states that the moment of momentum

$$p = p_\phi = m r^2 \dot{\phi}$$

is constant (r and ϕ are polar co-ordinates which we measured from the nucleus that is assumed motionless). The momentum in the ϕ -direction (projection of the moment of momentum on the tangent to the circle $r = \text{const.}$) is then $m r \dot{\phi} = p/r$, and the total momentum is $m v = m \beta c$. From these we get, by Pythagoras' theorem, the momentum in the direction r as :

$$p_r = m \dot{r} = \sqrt{(m v)^2 - \frac{p^2}{r^2}}$$

For the azimuth ϕ the quantum condition is :

$$\int_0^{2\pi} p_\phi d\phi = 2\pi p = n h, \quad p = \frac{n h}{2\pi} \quad (18)$$

For the radius vector r it is :

$$\int p_r dr = \oint \sqrt{(m v)^2 - \frac{p^2}{r^2}} dr = n' h \quad (19)$$

the integration stretching over the full series of values of r , that is, from r_{min} to r_{max} and back to r_{min} which, as in Note 6, may be indicated by adding the sign \bigcirc to the integral sign.

To be able to evaluate the integral (19) we must know $m v$ as a function of r . At present, however, m and hence $m v = m \beta c$ is known to us by (16a) only as a function of β . We may now use the energy theorem and the formula (17a) for the kinetic energy to get β out of it as a function of r . If we set the nuclear charge equal to E and hence the potential energy equal to $-\frac{eE}{r}$, then the law of energy states that :

$$E_{kin} = W - E_{pot} = W + \frac{eE}{r}$$

If we now apply eqn. (17a) we get

$$\frac{m_0 c^2 \beta^2}{2} \left(1 + \frac{3}{5} \beta^2 \right) = W + \frac{eE}{r}$$

* Cf. Abraham, *loc cit.*

From this we may calculate β and hence also $mc\beta \cdot mr$ by taking account of the significance of m in eqn. (16a). The calculation is, of course, performed by successive approximation, the first approximation being made with respect to the corrective term of the second order. We write the result in a form that embraces both the absolute theory and the theory of relativity, namely

$$(mr)^2 = 2m_0 \left(W + \frac{eE'}{r} \right) \left[1 + \frac{\gamma}{m_0 c^2} \left(W + \frac{eE'}{r} \right) \right] \quad (20)$$

where γ has the meaning

$$\begin{aligned} \gamma &= \frac{2}{3} \text{ for the absolute theory,} \\ \gamma &= \frac{1}{2} \text{ for the theory of relativity.} \end{aligned}$$

We next apply eqn. (20) in the quantum condition (19), of which the integrand now appears as a simple function of r . The integration may be effected by the scheme given under (c) in Note 6, and finally gives us:

$$1 + 2\gamma \frac{W}{m_0 c^2} = \left\{ 1 + \frac{2\gamma \left(\frac{E'}{e} \right)^2}{\left[n' + \sqrt{n'^2 - 2\gamma \left(\frac{eE'}{e} \right)^2} \right]^2} \right\}^{-1/2} \quad (21)$$

When $\gamma = \frac{1}{2}$, this equation passes over into the earlier relativistic eqn. (23) on page 472. This must not be regarded as self-evident, for the present calculation was an approximate calculation which made use only of the first powers of β^2 and worked with series that had been cut off, so that it may be regarded as trustworthy only to the first powers of α^2 . The fact that it proves to be accurate beyond this in the relativistic case ($\gamma = \frac{1}{2}$), must be regarded as an accident that comes about through the compensation of the various terms neglected. In the case of the absolute theory ($\gamma = \frac{2}{3}$), eqn. (21) is actually not the exact expression for the energy but only an approximation. It may be remarked that in the relativistic case the course here followed may also be pursued without neglecting quantities if we insert in (19) the exact value of v^2 that follows from the law of energy.

Our present eqn. (21) differs from the eqn. (23) on page 472 in that α^2 on the right side is replaced by $2\gamma\alpha^2$, and W on the left is replaced by $2\gamma W$. Consequently the development in powers used at the beginning of § 2 of the present chapter may be applied directly to our present eqn. (21). For example in the term expression (6) on page 476 we have only to write $2\gamma\alpha^2$ in place of α^2 . From this it follows, however, that all our theorems concerning fine-structure remain preserved, so long as we substitute $2\gamma\alpha^2$ for α^2 . The relative quantities of the fine structures, for example the interval 1:3 between the components in the triplet of the hydrogen type, the interval 1:2:6 between the components in the quartet of the hydrogen type, and so forth, also remain preserved in the absolute theory.

Only the absolute quantities of the fine-structures become diminished by the factor

$$2\gamma = \frac{4}{5}$$

in comparison with those of the theory of relativity.

In particular, this holds of the hydrogen doublet

$$\Delta\nu_{H} = \frac{4}{5} \cdot \frac{R\alpha^2}{2^4} = \frac{4}{5} \cdot 0.36 = 0.29 \text{ cm}^{-1}.$$

This value for the size of the hydrogen doublet is in no wise compatible with Paschen's measurements of the He^+ -lines. The same may be said of the hydrogen doublet in the Röntgen region, of the L-doublets, and so forth. According to the absolute theory these, too, should come out one-fifth smaller than the values observed for them. The latter, too, are then incompatible with the absolute theory. *Condensing these statements we may conclude that the absolute theory comes to grief owing to spectroscopic facts and has to give up to the theory of relativity the position of sovereignty which it formerly occupied.*

In this chapter we have seen how the theory of relativity, just as it has remodelled all our physical thought and ideas, has also been able to help forward spectroscopy in a decisive manner. Conversely, we note that, in return, spectroscopy is in a position to lend support to one of the main pillars of the theory of relativity and to decide in its favour the question of the variability of mass of the electron.

MATHEMATICAL NOTES AND ADDENDA

1. Radiation of Energy according to Classical Electrodynamics

(Pp. 25 and 33)

THE formulæ (1) of the text represent the field of a spherical wave on the basis of the Maxwell-Lorentz equations. They have been derived, for example, by Abraham, *Theorie der Elektrizität*, I, 6th ed., § 79, eqn. (246). The energy-flux \mathbf{S} is in general given by

$$\mathbf{S} = \frac{c}{4\pi} [\mathbf{E}\mathbf{H}],$$

if \mathbf{E} is measured electrostatically and \mathbf{H} electromagnetically, both in C.G.S. units; here $[\mathbf{E}\mathbf{H}]$ denotes the vector product of \mathbf{E} and \mathbf{H} . The magnitude of the vector, as we know, is equal to the area of the parallelogram formed by the two vectors \mathbf{E} and \mathbf{H} , that is, equal to

$$|\mathbf{E}| \cdot |\mathbf{H}| \cdot \sin(\mathbf{E}, \mathbf{H}).$$

If \mathbf{E} and \mathbf{H} are mutually perpendicular, then the formula (2) of the text results. We regard the normal to the plane of the parallelogram as the direction of the vector product, the direction of the normal being that which forms a right-handed screw when we turn in the direction from \mathbf{E} to \mathbf{H} . The integration over the sphere (surface-element $d\sigma = r^2 \sin \theta d\theta d\phi$) leads to

$$\begin{aligned} \int \mathbf{S} ds &= \frac{e^2 \dot{v}^2}{4\pi c^3} \int_0^{2\pi} d\phi \int_0^\pi \sin^2 \theta \sin \theta d\theta \\ &= \frac{e^2 \dot{v}^2}{2c^3} \int_\pi^0 (1 - \cos^2 \theta) d(\cos \theta) = \frac{e^2 \dot{v}^2}{2c^3} \left(2 - \frac{2}{3} \right) = \frac{2}{3} \cdot \frac{e^2 \dot{v}^2}{c^3}, \end{aligned}$$

as given in eqn. (3) of the text.

Eqn. (14) of the text (field of a spherical wave, whose origin advances with the speed βc) is derived in Abraham, *Theorie der Elektrizität*, II, 3rd ed., §§ 13 and 14, eqns. (73), (75), and (78). Nowadays it is more in conformity with our present knowledge to derive it directly from eqns. (1) of the text by means of a Lorentz-transformation.

The transition in the text from eqn. (15) to eqn. (16) comes about thus: we have

$$\int \mathbf{s} dt = \int \mathbf{s} \left(\frac{dt}{dt'} \right) dt'.$$

Here t denotes the time at which the radiation reaches the point of observation, t' the time at which it is emitted by the electron. On account of $t - t' = r/c$ we get [cf. Abraham *loc. cit.*, eqn. (75)]:

$$\frac{dt}{dt'} = 1 - \beta \cos \theta, \quad \text{thus } \bar{S} = \frac{e^2 \sin^2 \theta}{4\pi c^3 r^2} \int_{\beta}^0 \frac{v^2 dt'}{(1 - \beta' \cos \theta)^5}$$

β is a measure of the initial velocity, β' of the decreasing velocity during the retardation. For a constant retardation β' we get

$$d\beta' = \frac{\dot{v}}{c} dt', \quad \text{thus } \bar{S} = \frac{e^2 \dot{v} \sin^2 \theta}{4\pi c^2 r^2} \int_{\beta}^0 \frac{d\beta'}{(1 - \beta' \cos \theta)^5}$$

If we carry out the integration, eqn. (16) of the text results, and if we develop the expression in powers of β and neglect the higher powers, we get eqn. (17).

2. Scattering produced by Bound Electrons. (P. 30)

If the electrons of the radiator are not assumed free, but bound by the restoring force $-fx$ to the position of rest $x = 0$, then, in place of eqn. (5) of the text, we get, if we take the direction of motion as the x -axis:

$$m\ddot{x} + fx = -e\mathbf{E}_p. \tag{a}$$

To perform the integration we must now divide up \mathbf{E}_p and x spectrally. Let

$$\mathbf{E}_p = \int \mathbf{E} e^{i\omega t} d\omega, \quad x = \int \xi e^{i\omega t} d\omega$$

(continuous spectrum). Further, let $\sqrt{\frac{f}{m}} = \omega_0$ be the natural frequency of the binding connexion. We assume that it lies, say, somewhere in the Schumann region of the ultra-violet. Then it follows from (a) that

$$\begin{aligned} \xi(\omega_0^2 - \omega^2) &= -\frac{e}{m} \mathbf{E}, & x &= -\frac{e}{m} \int \frac{1}{(\omega_0^2 - \omega^2)} \mathbf{E} e^{i\omega t} d\omega, \\ \dot{v} = \ddot{x} &= \frac{e}{m} \int \frac{\omega^2}{\omega_0^2 - \omega^2} \mathbf{E} e^{i\omega t} d\omega \end{aligned} \tag{b}$$

In the Röntgen region $\omega \gg \omega_0$ we therefore have

$$\dot{v} = -\frac{e}{m} \int \mathbf{E} e^{i\omega t} d\omega = -\frac{e}{m} \mathbf{E}_p$$

as given in eqn. (5) of the text.

In the visible region $\omega \ll \omega_0$ we must on the other hand make the approximation inversely by means of

$$\dot{v} = \frac{-e}{m\omega_0^2} \int \omega^2 \mathbf{E} e^{i\omega t} d\omega.$$

To arrive from this at a formula of scattering that allows comparison with experiment we do best to proceed as follows. Let us restrict ourselves to monochromatic light of the frequency $\omega = 2\pi c/\lambda$. The following is then true, independently of the pitch of the frequency :

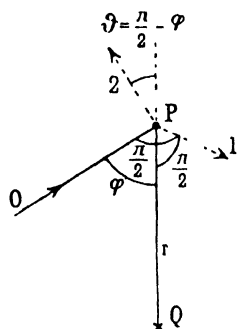

FIG. 122.

$$\dot{v} = -\omega^2 x = -\omega^2 \xi e^{i\omega t} \tag{c}$$

Let the incident plane wave, having the direction OP in Fig. 122, be assumed unpolarised. We consider a definite direction PQ of the scattered radiation, starting from P (P is the scattering particle, Q the point of observation, the length PQ = r) and divide the incident wave into two components P1 and P2, the one being perpendicular to the plane OPQ, the other lying in this plane and perpendicular to OP. The former, P1, forms the angle $\theta = \pi/2$ with r; the latter, P2, forms the angle $\theta = \pi/2 - \phi$ with r, where ϕ denotes the angle OPQ between the incident and the scattered ray.

If we insert (c) in eqn. (2) on page 25 of the text and take the mean value over the time, then

$$\bar{S} = \frac{\omega^4}{4\pi c^3 r^2} \cdot \frac{\sin^2 \theta}{2} (e\xi)^2$$

$\theta = \pi/2$ and $\sin \theta = 1$ for the component P1; $\theta = \pi/2 + \phi$ and $\sin \theta = -\cos \phi$ for the component P2. Hence for the sum of the two components, and for the action of a single scattering particle, we get

$$\bar{S} = \frac{\omega^4}{4\pi c^3 r^2} \cdot \frac{1 + \cos^2 \phi}{2} (e\xi)^2 \tag{d}$$

Under the conditions prevalent in optics the electrons that belong to the same molecule vibrate *coherently*; hence it is not their energy radiations \bar{S} but their amplitudes ξ that become superposed. Hence in (d) we have to write $(Se\xi)^2$, instead of $(e\xi)^2$, if we proceed to deal with the whole molecule and take \bar{S} to mean the summation over all the electrons of the individual molecule. On the other hand, the electrons that belong to different molecules oscillate *incoherently*, so that, in summing over various molecules, not the *amplitudes* but the *energies* have to be superposed. We thus get for the radiation scattered by unit volume, if we set $\omega = 2\pi c/\lambda$:

$$\bar{S}_1 = \frac{4\pi^3 c}{\lambda^4 r^2} \cdot \frac{1 + \cos^2 \phi}{2} \sum (Se\xi)^2 \tag{e}$$

The sign \sum denotes summation over all molecules of the unit volume. $\sum Se\xi$ is thus the electrical moment of the unit of volume, and, by the definition of the index of refraction of a sufficiently rarefied gas which is traversed by a light wave of electrical amplitude E , this is equal to $\frac{n^2 - 1}{4\pi} E$. (In a dense gas or a fluid $\frac{3(n^2 - 1)}{n^2 + 2}$ takes the place

of $n^2 - 1$). From $\sum Se\xi = \left(\frac{n^2 - 1}{4\pi}\right)E$ it follows that (L denoting Avogadro's number per unit volume):

$$Se\xi = \frac{n^2 - 1}{4\pi L}E, \quad \sum (Se\xi)^2 = \frac{(n^2 - 1)^2}{16\pi^2 L}E^2.$$

Accordingly, from (e) we get

$$\mathbf{s}_1 = \frac{\pi c}{\lambda^4 r^2} E^2 \frac{1 + \cos^2 \phi}{2} \cdot \frac{(n^2 - 1)^2}{4L}.$$

By eqn. (2) of the text the incident energy is, when averaged over the time and calculated as the sum for both directions of polarisation,

$$\mathbf{s}_0 = \frac{c}{4\pi} E^2.$$

Accordingly

$$\frac{\mathbf{s}_1}{\mathbf{s}_0} = \frac{\pi^2}{\lambda^4 r^2} \cdot \frac{1 + \cos^2 \phi}{2} \cdot \frac{(n^2 - 1)^2}{L} \quad (f)$$

Eqn. (f) is identical with Rayleigh's formula for the intensity of the scattered light in the atmosphere. The factor $1/\lambda^4$ accounts for the predominance of the short wave-lengths, that is, the blue colour of the sky. The formula may be used to determine Loschmidt's (Avogadro's) number. The best and most recent observations, made on Teneriffe Peak* led to

$$L = 2.89 \cdot 10^{19},$$

whereas Planck's value, derived from the theory of radiation, is

$$L = 2.76 \cdot 10^{19}.$$

The above considerations, taken from the optical region, are appropriate for bringing into clear relief the limits of validity to which the equations (4) to (10) of the text (p. 30) are restricted. For optical purposes we were allowed to superpose the fields (amplitudes) and *not* their radiations (intensities) in the case of the electrons of a single molecule. The interesting fact about our earlier calculation in the Röntgen region was that it was furnished by the total number Z of the electrons of an atom, when we superposed the intensity of these Z electrons. In the optical case the wave-length is great compared with the distances between the electrons within the same molecule, and that is why the latter vibrate coherently. In the Röntgen region the wave-length must be small if we wish to be able to deal with the complete incoherence of the waves in our calculations, that is with the superposition of the intensities. Thus, our mode of calculation is valid only for *sufficiently hard* Röntgen rays.

Yet, for hard Röntgen rays too, there is a region, namely a cone described about the continuation of the direction of incidence of the primary rays, in which the coherence of the scattered radiation must also be taken into consideration, and for which, consequently, interference

* Cf. Dember, Ann. d. Phys., 49, 609 (1916).

may occur. As the rays become softer this cone becomes enlarged and hence eqn. (4) of the text involves an appreciable error. In the optical case the aperture of the cone becomes equal to π and the whole space belongs to the interior of the cone. The interferences hereby indicated for the Röntgen region in the neighbourhood of the extension of the incident direction were first observed by W. Friedrich* for wax, and were then investigated systematically by P. Debye.† It was also Debye‡ who worked out fully the theory which we have here merely hinted at for these interference phenomena.

Connected with this, there is an apparent contradiction between our calculation of the scattered Röntgen energy and the facts of crystal analysis as disclosed by Röntgen rays: in the case of the former we superpose the *intensity* radiated out by the Z electrons, in the latter their *amplitude*. For it is confirmed by Röntgen photographs of crystals that each atom of the crystal makes a contribution to the scattering field, that is to the *amplitude* of the scattered radiation, and that this contribution is proportional to the atomic number of the crystal. But this contradiction is cleared up by the fact that within the Debye cone the interferences of the fields emitted by the individual electrons of the atom must be taken into account. The rays that are diffracted or scattered in crystal analysis form no very great angle with the primary ray and hence in general lie within the above critical cone, especially when the primary radiation is not very hard. The occurrence of Friedrich-Debye interferences within this cone shows at once that in this case the fields, that is the amplitudes, must be superposed. For the whole radiation of the atom, however, which is for the greater part sent out into the exterior of the cone, the superposition of intensities may essentially take the place of that of the amplitudes.

It remains unintelligible why, in the case of γ -rays, for which the assumptions made in the text should be best fulfilled, we should get the value 0.04 for s/ρ [eqn. (10) of the text] instead of the value 0.2 [eqn. (12) of the text].§ In agreement with the latter value W. Kohlrausch|| gets for the total coefficient of extinction of the γ -rays (true coefficient of absorption + coefficient of scattering) a value less than 0.2 for a radium salt. And in measurements made by C. W. Hewlett¶ we may trace how the total coefficient of extinction of very hard Röntgen rays in the vicinity of the wave-length $\lambda = 10^{-9}$ continually decreases and passes below the value 0.2. In this case we are clearly dealing with a fundamental departure from the optics of waves, a departure which is probably due to the size of the energy quantum of very hard rays.

* Physikal. Zeitschrift, **14**, 317 (1913).

† Göttinger Nachrichten, 18th Dec., 1915.

‡ Ann. d. Phys., **43**, 49 (1914).

§ Cf. Rutherford and Richardson, Phil. Mag., **26**, 324 (1912); Ishino, *ibid.*, **33**, 129, (1917).

|| Wiener Berichte, **126**, Part II *a*, sections 4 and 6.

¶ Phys. Rev., **17**, 284 (1921).

3. Tables of the Crystal Structures Hitherto Investigated.

(Chapter III, § 2.)

(a) *Simple cubic face-centred lattice* (cf. Fig. 34, p. 123 from which the darkened circles are to be imagined absent). These lattices occur, of course, only in the case of *elements*. The lattice is completely determined by the length of edge a of the elementary cube (Fig. 34). Each elementary region contains 4 atoms. The order of sequence in Table 58 corresponds to the groups of the periodic system.

TABLE 58

Crystal	$a \cdot 10^8$ cm.	Observer	Remarks
Copper, Cu . . .	3.61	W. H. Bragg	Phil. Mag., 28 , 355 (1914).
Silver, Ag . . .	4.06	Vegard	" " 31 , 83 (1916).
Gold, Au . . .	4.07	"	" " 32 , 65 (1916).
Calcium, Ca . . .	5.56	Hull	Phys. Rev., 17 , 42 (1921).
Aluminium, Al . . .	4.07	Scherrer	Phys. Zeitschr., 19 , 23 (1918).
Cerium, Ce . . .	5.12	Hull	Phys. Rev., 18 , 88 (1921); see also under (e).
Thorium, Th . . .	5.11	H. Bohlin	Ann. d. Phys., 61 , 421 (1919).
" " . . .	5.04	Hull	Phys. Rev., 18 , 88 (1921).
Lead, Pb . . .	4.91	Vegard	Phil. Mag., 32 , 65 (1916).
Nickel alloy . . .	3.58	Westgren	Engineering, 111 , 727 (1921).
Manganese alloy . . .	3.61	"	Pure iron (Fe γ) has the same structure above 1000°; see also under (b).
Cobalt α , Co . . .	3.554	Hull	See also under (e).
Nickel, Ni . . .	3.540	"	} Phys. Rev., 17 , 571 (1921).
Rhodium, Rh . . .	3.820	"	
Palladium, Pd . . .	3.950	"	
Iridium, Ir . . .	3.805	"	
Platinum, Pt . . .	3.930	"	

(b) *Simple cubic space-centred lattice*. The elementary region is a cube of which besides the corners the mid-point is also occupied. The number of atoms in the elementary region is 2. The lattice is fully described by the length a of the edge of the cube.

TABLE 59

Crystal	$a \cdot 10^8$ cm.	Observer	Remarks
Lithium, Li . . .	3.50	Hull	} Phys. Rev., 10 , 661 (1917).
Sodium, Na . . .	4.30	"	
Tantalum, Ta . . .	3.272	"	} Phys. Rev., 17 , 571 (1921).
Chromium, Cr . . .	2.895	"	
Molybdenum, Mo . . .	3.143	"	
Tungsten, W . . .	3.18	Debye	Phys. Zeitschr. 18 , 438 (1917).
" " . . .	—	R. Grossmann- N. Blassman	} N. Jahrb. f. Min. 42 , 728 (1919).
Iron α , Fe . . .	2.83	Westgren	
" β , Fe . . .	?	"	(Ordinary temperatures.) } Engineering, 111 , 727 (1921) (Temperature > 768°).

(c) "*Diamond lattice.*" The description of this lattice is contained in Figs. 36 and 37 on page 125. A knowledge of the edge a of the cube suffices to fix it. There are 8 atoms in each elementary region.

TABLE 60

Crystal	$a \cdot 10^8$ cm.	Observer.	Remarks
Diamond, C	3.55	Bragg	Proc. Roy. Soc., 89 , 277 (1913); see also X-Rays and Crystal Structure, London, 1916.
Silicon, Si	5.46	Debye and Scherrer	Phys. Zeitschr., 17 , 277 (1916).
" "	5.400	Gerlach-Madelung-Pauli	Phys. Zeitschr., 22 , 557 (1921).
Tin (gray), Sn	6.46	Bijl-Kolkmeijer	Proc. Amsterdam 21 , 501 (1919).

According to Bijl-Kolkmeijer, *loc. cit.*, page 494, white tin has a tetragonal lateral-surface-centred lattice. The edge of the square base is

$$a = 5.84 \cdot 10^{-8} \text{ cms. ;}$$

the height of the centred lateral surface is $c = 2.37 \cdot 10^{-8}$ cms.; these give for the ratio of the axes: $c : a = 0.406$. According to Hull, Indium has the same lattice, Phys. Rev., **17**, 571 (1921).

(d) *Rhombohedral lattice.* There are 8 atoms in the elementary rhombohedra of the rhombohedral lattices described on page 126 (cf. Fig. 38). The rhombohedron is determined by the length of edge a and the angle α between the edges. To this there must be added the relative value u of the displacement of the two surface-centred lattices with respect to each other along the diagonal, expressed in terms of the length of the diagonals of the rhombohedron.

TABLE 61

Crystal	$a \cdot 10^8$ cm.	α	u	Observer	Remarks
Graphite, C	4.48	68° 26'	0.33	Debye-Scherrer	Phys. Zeitschr., 18 , 291 (1917).
Arsenic, As	4.14	54° 8'	?	Bragg	X-Rays.
Antimony, Sb	4.50	563° 6'	0.463	James-Tunstall	Phil. Mag., 40 , 293 (1920).
Bismuth, Bi	4.72	57° 16'	?	Bragg	X-Rays.

(e) *Hexagonal lattices, approximating to closely packed spheres.* The arrangement of the atoms in this case has been accurately described on page 127. The lattice is determined by the length a of the sides of the triangular base and by the ratio $c : a$ of the axes. The closest possible packing of exact spheres would lead to the ratio of axes $c : a = 1.633$. There are two atoms in the elementary region of the hexagonal lattice.

3. Tables of the Crystal Structures Hitherto Investigated 539

TABLE 62

Crystal	a , 10^8 cm.	c , 10^8 cm.	$c : a$	Observer	Remarks
Beryllium, Be .	2.29	3.62	1.58	M. Meier	} Diss. Göttingen, 1921.
Magnesium, Mg	3.19	5.20	1.628	"	
" "	3.22	5.23	1.626	Hull	} Phys. Rev., 10 , 661 (1917).
Zinc, Zn . . .	2.670	4.966	1.860	"	
Cadmium, Cd .	2.960	5.60	1.89	"	} Phys. Rev., 17 , 571 (1921).
Titanium, Ti .	2.97	4.72	1.59	"	
Zirconium, Zr .	3.23	5.14	1.59	"	} Phys. Rev., 18 , 88 (1921).
Cerium, Ce . .	3.65	5.96	1.62	"	
Cobalt β , Co .	2.514	4.11	1.633	"	Phys. Rev., 18 , 88 (1921) (cf. also under a).
Ruthenium, Ru	2.686	4.272	1.59	"	} Phys. Rev., 17 , 571 (1921). (cf. also under a).
Osmium, Os . .	2.714	4.32	1.59	"	

(f) *Lattices of the rock-salt type.* The lattice represented in Fig. 34 is fully described if we know the edge a of the cube. The elementary cube contains 4 + 4 atoms. The position of the H-atoms in the case of NH_4Cl and NH_4Br is not known with certainty; it must at any rate be symmetrical with respect to the N-atom, which for its part takes the position of Na in the NaCl type. Concerning the transition to the type (g) for decreasing temperature, cf. page 123.

TABLE 63

Crystal	a , 10^8 cm.	Observer	Remarks
Li F	4.03	Debye-Scherrer Bragg	} Phys. Zeitschr., 17 , 277 (1916).
Rocksalt, NaCl .	5.628		
Sylvine, KCl . .	6.26	"	} X-Rays.
KBr	6.57	"	
KJ	7.05	"	} Zeitschr. f. Phys., 5 , 17 (1921).
NH_4Cl	6.577	Vegard	
"	6.532	} Bartlett- Langmuir	} Journ. Amer. Chem. Soc., 43 , 84 (1921). NH_4Cl u. NH_4Br at 250° , NH_4J at 20° .
NH_4Br	6.96		
NH_4J	7.20	"	
Magnesium, MgO (Periclas)	4.22	Hull	Journ. Amer. Chem. Soc., 41 , 1168 (1919).
Magnesium, MgO (Periclas)	4.204	Gerlach-Madelung- Pauli	Phys. Zeitschr., 22 , 557 (1921).
Lime, CaO . . .	4.74	Davey-Hoffmann	Phys. Rev., 15 , 333 (1920).
" "	4.762	Gerlach-Madelung- Pauli	Phys. Zeitschr., 22 , 557 (1921).
SrO	5.100	"	" " " "
BaO	5.47	"	" " " "
CaO	4.72	Davey-Hoffmann	} Phys. Rev., 15 , 333 (1920).
NiO	4.20	"	
Pbs	5.94	Bragg	X-Rays.

(g) *Lattices of the type of CsCl.* The lattice described on page 123 is determined by the edge of the cube, a . The elementary cube contains

1 + 1 atoms. Concerning the position of the H-atoms in the case of NH_4Cl , and so forth, and the transition to the type (*f*) for increasing temperatures, cf. what was said under (*f*).

TABLE 64

Crystal	$a \cdot 10^8$ cm.	Observer	Remarks
CsCl	4.12	Davey-Wick	} Phys. Rev., 17 , 403 (1921).
TlCl	3.85	"	
NH_4Cl	3.859	Bartlett-Langmuir	Journ. Amer. Chem. Soc., 43 , 84 (1921), at 20° C.
"	3.889	Vegard	Zeitschr. f. Phys., 5 , 17 (1921).
NH_4Br	3.988	Bartlett-Langmuir	Journ. Amer. Chem. Soc., 43 , 84 (1921), at 20° C.
"	4.070	Vegard	Zeitschr. f. Phys., 5 , 17 (1921).

(*h*) *Lattices of the type of zincblende.* The lattice of ZnS represented in Fig. 36, page 125, is determined by the edge of the cube, a . The elementary cube contains 4 + 4 atoms. The lattice of CSi is identical with that of ZnS . According to page 125 the lattice of CaF_2 is related to that of ZnS .

TABLE 65

Crystal	$a \cdot 10^8$ cm.	Observer	Remarks
Zincblende, ZnS .	5.11	Bragg	X-Rays.
Carborundum, CSi .	—	Hull	Phys. Rev., 13 , 292 (1919).
Fluorspar, CaF_2 .	—	Bragg	X-Rays.

(*i*) *Lattices of the type of calcite* (substances of the form MNO_3). The lattice represented in Fig. 35, page 125, is determined by the rhombohedral edge a , the angle α between the edges at the pole and the distance x of the 6 atoms from the centre of the acid radical. The elementary region contains 4 + 4 + 3.4 atoms.

TABLE 66

Crystal	$a \cdot 10^8$ cm.	α	$x \cdot 10^8$ cm.	Observer	Remarks
CaCO_3	6.08	101° 55'	1.21	Wyckoff	} Structure accord- ing to Bragg. Amer. J. of Sci., 50 , 317 (1920).
Rhodochrosite, MnCO_3 .	5.66	103° 6'	1.225	"	
Siderite, FeCO_3	5.66	103° 4½'	1.225	"	
NaN_3	6.08	102° 47'	1.21	"	

4. Proof of the Invariance of Hamilton's Equations for Arbitrary Changes of Co-ordinates

Contact Transformations

(To Chapter IV, § 1)

In the text, by using rectilinear co-ordinates $q_k = x, y, z$ for a single mass-point, and assuming that there was a potential energy that depended only on the q_k 's, we directly deduced from Newton's foundation of mechanics the existence of the Hamiltonian equations :

$$\frac{dq_k}{dt} = \frac{\partial H}{\partial p_k}, \quad \frac{dp_k}{dt} = - \frac{\partial H}{\partial q_k}, \quad p_k = \frac{\partial E_{kin}}{\partial \dot{q}_k} \quad . \quad . \quad . \quad (1)$$

But what holds for one point-mass also holds, as was remarked on page 195, for a *system of point-masses* between which conservative forces act. Eqns. (1) hold for each of these if we take q_k as representing in succession the rectilinear co-ordinates of each individual point of the system. We shall now show that the form of eqns. (1) also remain preserved if, by means of an arbitrary "point-transformation" (not containing the time), we introduce new co-ordinates of position

$$Q = f_k(q_1, q_2, \dots) \quad . \quad . \quad . \quad (2)$$

in place of the rectangular co-ordinates.

For this purpose we imagine the q_k 's to be calculated from (2) as functions of the Q_k 's. The \dot{q}_k 's deduced from them by differentiation with respect to t will be linear functions of the \dot{Q}_k 's and will have coefficients that depend on the Q_k 's. The kinetic energy, expressed in terms of the rectangular co-ordinates of velocity, is a homogeneous quadratic function of the \dot{q}_k 's. As in (1) we designate it by E_{kin} . If we here insert the values of the \dot{q}_k 's in the E_{kin} 's, Q_k 's, we get a homogeneous quadratic function of the \dot{Q}_k 's with coefficients that depend on the Q_k 's. We call this function $\bar{E}_{kin}(Q_k, \dot{Q}_k)$ and have by definition

$$E_{kin}(\dot{q}_k, Q_k) = \bar{E}_{kin}(\dot{Q}_k, Q_k) \quad . \quad . \quad . \quad (3)$$

From homogeneity it follows that

$$E_{kin} = \frac{1}{2} \sum_k \frac{\partial E_{kin}}{\partial \dot{q}_k} \dot{q}_k, \quad \bar{E}_{kin} = \frac{1}{2} \sum_k \frac{\partial \bar{E}_{kin}}{\partial \dot{Q}_k} \dot{Q}_k$$

Just as in eqns. (1) p_k was defined by differentiation of E_{kin} , we now define P_k by setting

$$P_k = \frac{\partial \bar{E}_{kin}}{\partial \dot{Q}_k} \quad . \quad . \quad . \quad (4)$$

We then have

$$E_{kin} = \frac{1}{2} \sum_k p_k \dot{q}_k, \quad \bar{E}_{kin} = \frac{1}{2} \sum_k P_k \dot{Q}_k \quad . \quad . \quad (5)$$

and from (3) we conclude that

$$\sum_k P_k \dot{Q}_k = \sum_k p_k \dot{q}_k \quad . \quad . \quad . \quad (6)$$

This equation may serve to define P_k in place of (4). For, calculating the \dot{q}_k 's as linear functions of the \dot{Q}_k 's by differentiating (2) with respect to t , then inserting these in (6) and comparing the coefficients of \dot{Q}_k on both sides, we get the P_k 's as linear functions of the p_k 's with coefficients that depend on the Q_k 's. If we reverse these relations and insert the expressions for the p_k 's so obtained and the q_k 's obtained from (2) in the Hamiltonian function $H(p, q)$, we get Hamilton's function expressed in terms of the co-ordinates P, Q ; we call it $\bar{H}(P, Q)$, and, by definition, we have

$$\bar{H}(P_k Q_k) = H(p_k q_k) \quad . \quad . \quad . \quad . \quad (7)$$

What our assertion amounts to now is that in the quantities $P_k, Q_k, \bar{H}(P, Q), \bar{E}_{kin}(P, Q)$ so defined, the Hamiltonian equations

$$\frac{dQ_k}{dt} = \frac{\partial \bar{H}}{\partial P_k}, \quad \frac{dP_k}{dt} = - \frac{\partial \bar{H}}{\partial Q_k} \quad . \quad . \quad . \quad . \quad (8)$$

again hold.

To make the proof capable of being generalised as far as possible we apply the method of the calculus of variations. Although we have nothing new to say about it, we shall summarise the essential points here for the convenience of the reader. We first suppose the differential eqns. (1) of the mechanics of a point (kinematics) to be compressed into the form of d'Alembert's principle. This gives us the advantage of being able to pass from the hitherto assumed system of isolated point-masses to a mechanical system with arbitrary inner relationships.

As we are aware, d'Alembert's principle asserts that the external forces are in equilibrium with the inertial resistances in virtue of the relationships of the system. To test whether this equilibrium persists after the system has undergone infinitely small virtual displacements ("virtual" means compatible with the inner relationships of the system), we postulate that the work done by the external forces and the inertial resistances (i.e. the "virtual work") must vanish.

Let the rectangular components of the external forces be denoted by K_k in succession. The inertial resistances, which for the present we also assume resolved into rectangular components, are also given by $-\dot{p}_k$. The principle is then expressed by :

$$\sum (K_k - \dot{p}_k) \delta q_k = 0 \quad . \quad . \quad . \quad . \quad (9)$$

The connexions that may happen to exist between the point-masses need not be taken into consideration since they do no work during the virtual displacement δq_k .

We assume that the external forces have a potential. Then

$$\sum K_k \delta q_k = - \delta E_{pot} \quad . \quad . \quad . \quad . \quad (10)$$

must hold.

Furthermore,

$$E_{kin} = \sum \frac{m_k}{2} \dot{q}_k^2, \quad \delta E_{kin} = \sum p_k \delta \dot{q}_k$$

$$\dot{p}_k \delta q_k = \frac{d}{dt} \sum p_k \delta q_k - \sum p_k \delta \dot{q}_k = \frac{d}{dt} \sum p_k \delta q_k - \delta E_{kin} \quad (11)$$

Hence it follows from (9), (10), and (11) that

$$\frac{d}{dt} \sum p_k \delta q_k = \delta(E_{kin} - E_{pot}) = \delta L$$

(L is the "Lagrange function"), and if we integrate from 0 to t (let the integration variable be denoted by τ to distinguish it from t) then

$$\sum p_k \delta q_k \Big|_0^t = \int_0^t \delta L d\tau \quad (12)$$

We revert to this equation in Note 7. At present we use special cases of it by stipulating that: (1) At the limits 0 and t , δq_k must equal 0; (2) the time is not to be subjected to variation; that is, $\delta t = 0$. From (12) we then get Hamilton's principle

$$\delta \int_0^t L d\tau = 0 \quad (13)$$

We usually take it as a starting-point for deriving the general Lagrange equations, in which L is then regarded as a function of the q 's and \dot{q} 's. We shall use it here as a bridge to the Hamiltonian equations, that is, to our initial equations (1). From the definition of L and H,

$$L(q, \dot{q}) = E_{kin} - E_{pot}, \quad H(q, p) = E_{kin} + E_{pot},$$

we get, if we take into account (5),

$$L = 2E_{kin} - H = \sum p_k \dot{q}_k - H \quad (13a)$$

In place of (13) we may write

$$\delta \int_0^t [H(p, q) - \sum p_k \dot{q}_k] d\tau = 0 \quad (14)$$

(modified Hamiltonian principle) and we may further choose the q_k 's and p_k 's for the quantities to which we apply variation. We then get from (14):

$$\sum_k \int_0^t \left(\frac{\partial H}{\partial p_k} - \dot{q}_k \right) \delta p_k d\tau + \sum_k \int_0^t \frac{\partial H}{\partial q_k} \delta q_k d\tau - \sum_k \int_0^t p_k \delta \dot{q}_k d\tau = 0$$

Partial integration applied to the last integral, where we have to take into consideration that δq_k must equal 0 at the limits, changes the preceding equation into

$$\sum_k \int \left(\frac{\partial \bar{H}}{\partial p_k} - \dot{q}_k \right) \delta p_k d\tau + \sum_k \int \left(\frac{\partial \bar{H}}{\partial q_k} + \dot{p}_k \right) \delta q_k d\tau = 0 \quad (15)$$

since $\delta p_k, \delta q_k$ are arbitrary, this equation is identical with the eqns. (1).

Hitherto we have taken p_k and q_k as standing for rectilinear co-ordinates. By means of the point-transformation (2) we now pass on to arbitrary co-ordinates P_k, Q_k . As a result of (3), (5), and (7) equation (14) is expressed in terms of these new variables by:

$$\delta \int [\bar{H}(P_k, Q_k) - \sum P_k \dot{Q}_k] d\tau = 0 \quad (16)$$

The process of variation takes place exactly as in the case of the variables p_k, q_k , and leads to

$$\sum_k \int \left(\frac{\partial \bar{H}}{\partial P_k} - \dot{Q}_k \right) \delta P_k d\tau + \sum_k \int \left(\frac{\partial \bar{H}}{\partial Q_k} + \dot{P}_k \right) \delta Q_k d\tau = 0 \quad (17)$$

From this we directly deduce eqns. (8), which were to be proved. Thus, *the invariance of Hamilton's equations with respect to arbitrary point-transformations is a direct consequence of their deduction from the modified Hamiltonian principle.*

If we survey the preceding proof we realise that we assumed much more than was necessary for deriving the desired result of eqns. (8). In (6) and (7) we had assumed $\sum P_k \dot{Q}_k = \sum p_k \dot{q}_k$ and $\bar{H} = H$. But to pass from (14) to (17), it is only necessary to require, instead of this, that

$$H - \sum p_k \dot{q}_k = \bar{H} - \sum P_k \dot{Q}_k + F \quad (18)$$

Here F denotes an arbitrary function of, for example, the arguments q, Q and t , and F' denotes its complete differential quotient with respect to t . Actually the additional term due to F' in (16) drops out when we integrate with respect to τ , since it reduces to the values of δF at the limits, which in their turn, just like $\delta q, \delta Q, \delta t$, vanish. Our special point-transformation (2) with the complementary conditions (3), (4), and (7), of course, fulfils eqns. (18), in effecting that

$$\sum P_k \dot{Q}_k = \sum p_k \dot{q}_k, \quad \bar{H} = H, \quad F = 0.$$

But much more general transformations of the following form are compatible with eqns. (18):

$$Q_k = f_k(q_i, p_i, t), \quad P_k = g_k(q_i, p_i, t), \quad F = F(q_i, Q_i, t) \quad (19)$$

The manner of expressing F here chosen brings out clearly that for the sake of convenience, as already remarked, we wish to regard q, Q , and t as variables of F ; [if instead, we had chosen q, p, t for the arguments, as

we did in the first eqns. (19), then we should have been able to calculate p_i out of the first eqns. (19) and to insert it in F]. The choice of q, Q, t , as independent variables corresponds exactly to the analytical form of eqns. (18) and makes it easier to give the conditions which are imposed on the transformations (19) by the existence of (18). This choice, it is true, is possible only if q, Q , and t do not depend analytically on one another; it would be impossible if, as at the beginning of this section, equations of the form (2) were to hold.

We arrange eqns. (18) according to the differentials of the independent variables, we call dt the differential of t and use δ to indicate those differentiations with respect to q and Q , in which t is not subjected to variation. Accordingly we set

$$\dot{F}dt = \frac{\partial F}{\partial t}dt + \delta F$$

and write (18) thus:

$$\left(\bar{H} - H - \frac{\partial F}{\partial t}\right)dt + \sum p_k \delta q_k - \sum P_k \delta Q_k - \delta F = 0 \quad (20)$$

We next postulate that this condition be fulfilled for *all* virtual changes $\delta q, \delta Q, dt$ and this is at any rate *sufficient* for the existence of Hamilton's eqns. (8) [we do not hereby assert that this condition is at the same time *necessary*]. On account of the independence of the variables t, q, Q (20) may be resolved into two groups of postulates which must be fulfilled by the transformation (19). They are

$$\bar{H} = H + \frac{\partial F}{\partial t} \quad (20a)$$

$$\sum p_k \delta q_k = \sum P_k \delta Q_k + \delta F \quad (20b)$$

Eqn. (20b) shows directly, if we make only one of the quantities q_k, Q_k vary, that

$$p_k = \frac{\partial F}{\partial q_k}, \quad P_k = - \frac{\partial F}{\partial Q_k} \quad (20c)$$

holds. In the particular case in which the additional function F is chosen independently of t , eqn. (20a) reduces to the earlier eqn. (7). But in this case, too, eqn. (20b) is more general than eqn. (6), inasmuch as here the term δF becomes added, which (as F was assumed independent of t) may be designated a complete differential of the arbitrary function $F(q, Q)$.

Eqns. (19) obviously no longer represent "point transformations," inasmuch as, unlike (2) they no longer connect the point- or position-co-ordinates q, Q with one another, but with the impulse (or momentum) co-ordinates p, P . Moreover, since in the case of such a general transformation the mechanical significance of the momentum co-ordinates becomes lost to view, it is better to call the pairs of variables q, p on the one hand and Q, P on the other; *canonical variables*. P is *canonically conjugate* to Q , and likewise p to q . The general transformation of canonical variables that are thus only restricted by the conditions (20) is called *canonical transformation*. At the end of this note we shall raise the point as to how far the term *contact transformation* may be used

as an equivalent to it. In the most general case, when, namely, the function F depends on t , the canonical transformation not only connects the quantities q, p with Q, P but still more the quantities q, p, H with Q, P, H .

Under certain circumstances it is convenient to start from the quantities q, P, t as independent variables instead of q, Q, t , for example, in the case, which was above excluded, of an analytical relation between q, Q, t . It is easy to re-write eqns. (18) in such a way that they fit in with this view. It is only necessary to add $\sum Q_k \dot{P}_k$ on the right with a positive and negative sign and to consider instead of F the "modified" function

$$F^* = F + \sum P_k Q_k \quad . \quad . \quad . \quad . \quad (21)$$

Eqns. (18) then merge into the form

$$H - \sum p_k \dot{q}_k = H + \sum Q_k \dot{P}_k - F^* \quad . \quad . \quad . \quad (22)$$

By now treating $t, q,$ and P as independent variables it follows from these, analogous to eqns. (20a, b), that

$$H = H + \frac{\partial F^*}{\partial t} \quad . \quad . \quad . \quad . \quad (22a)$$

$$\sum p_k \delta q_k + \sum Q_k \delta P_k = \delta F^* \quad . \quad . \quad . \quad (22b)$$

From this point of vantage we get the "canonical conjugates" p, Q to the independent variables by means of the formulae

$$p_k = \frac{\partial F^*}{\partial q_k}, \quad Q_k = - \frac{\partial F^*}{\partial P_k} \quad . \quad . \quad . \quad (22c)$$

which are analogous to (20c). The term "modified function" F^* is to remind us, just like the term "modified Hamiltonian principle" (cf. p. 543) of the usual process in dynamics and thermodynamics in which we change the independent variable, a process which is to be traced back in an abstract form to Legendre and which is called *Legendre transformation*.

It only remains for us to give grounds for the term "contact transformation."

Let us consider a "surface" $s = s(q_1, q_2, \dots, q_f)$ in $f + 1$ -dimensional space, interpreting q_1, \dots, q_f as rectangular point-co-ordinates in a "plane" and erecting s perpendicular to it. Then the quantities

$$p_k = \frac{\partial s}{\partial q_k}$$

determine the position of the tangential plane at the surface s , and may therefore be called "plane-co-ordinates." The following "condition of combined position,"

$$ds = \sum_1^f p_k dq_k \quad . \quad . \quad . \quad . \quad (23)$$

holds between the point- and the plane-co-ordinates.

Let us introduce new co-ordinates Q_k, P_k by means of eqns. (19), whereby, however, we assume f and g to be independent of t in order to allow us to use a geometrical interpretation. Expressing the q_k 's in terms of Q_i and P_i by means of eqns. (19), we next form $s(q) = S(P, Q)$ and postulate that the new configuration S also represents a surface, that is, that it is touched by the planes given by the P 's at the points determined by the Q 's. Then it must be held as a consequence of (23) that

$$ds = \sum P_k dQ_k \quad . \quad . \quad . \quad . \quad . \quad (23a)$$

that is, if ρ denotes an arbitrary function of the q, p, s or Q, P, S , then :

$$dS - \sum_1^n P_k dQ_k = \rho \left(ds - \sum_1^n p_k dq_k \right) \quad . \quad . \quad . \quad (24)$$

This is the condition that is to allow us to apply the term *contact transformation in the geometrical sense* to our transformation (19).

In a certain respect our condition (20) is more special, in another it is more general, than the geometrical condition (24). The factor ρ was wanting in our condition (20); in its place, however, even if we leave out of account the member with dt , there occurred the additive term δF which was wanting in (24) for the case $\rho = 1$ and $S = s$. But it is just this generalisation that is important for mechanics. The theory of transformations of the differential equations of mechanics, founded by Lagrange and Poisson and developed by Jacobi, operates throughout with such generalised contact transformations.

Thus the geometric and mechanical conception of contact transformations is only partially identical.

5. Concerning the Ratio of the Kinetic to the Potential Energy in the Coulomb Field

(To Chapter IV, § 3, p. 214; § 4, p. 220; § 5, p. 228)

At the close of his first paper in *Phil. Mag.*,* Bohr makes the following statement :

“In every system of nuclei at rest and electrons that move in circles with velocities which are small compared with c the kinetic energy is, except in the sign, equal to half the potential energy.”

We shall show that this theorem applies much more widely: it holds not only for circular orbits but also for arbitrary forms of motion, in which (for varying kinetic and potential energy) the time-mean values of both energies have to take the places of the energy values themselves in the enunciation of the theorem. It also remains valid except for a small change if we allow any arbitrary central force to act in place of Coulomb's law of force.† It is not necessary nor even convenient in the sequel to assume the nuclei at rest.

* Vol. 26, p. 24 (1913).

† In what follows we continue from Burgers, *Diss. Haarlem*, 1918, p. 168, whose simple proof we extend to the case in which any central force, not merely Coulomb's, acts. This extension already occurs in Jacobi, *Vorlesungen über Dynamik*, p. 22.

We take as our basis rectilinear co-ordinates x, y, z which we distinguish by affixing numbers for the electrons and nuclei and denote by $q_1 \dots q_f$. Let $p_1 \dots p_f$ be the corresponding momenta. Then the kinetic energy of our system of nuclei and electrons can, by eqn. (5) of the preceding note, be put into the form :

$$E_{kin} = \frac{1}{2} \sum^{(k)} p_k \dot{q}_k \quad . \quad . \quad . \quad . \quad . \quad (1)$$

Let the potential energy be a homogeneous function of degree $n + 1$, of the co-ordinates q_k . This is the case, for example, if central forces proportional to r^n act between the point-masses of the system, that is, between the i th and j th point-mass (no matter whether it be nucleus or electron) a force acts in the line connecting both, its amount being $C_{ij} r_{ij}^n$ (n is the same throughout but C may under certain circumstances change from point-pair to point-pair). Then we get [cf. eqn. (3) on p. 194] :

$$E_{pot} = \frac{1}{n+1} \sum^{(k)} \frac{\partial E_{pot}}{\partial q_k} q_k = - \frac{1}{n+1} \sum_k \dot{p}_k \dot{q}_k \quad . \quad . \quad . \quad (2)$$

We next form

$$\frac{d}{dt} \sum p_k \dot{q}_k = \sum p_k \ddot{q}_k + \sum \dot{p}_k \dot{q}_k \quad . \quad . \quad . \quad . \quad (3)$$

and take the mean value in time, which we denote by a horizontal bar. If the motion is periodic or at all stable in the sense that the position of the point-masses does not systematically deviate from its initial configuration to an extent that increases indefinitely with the time, the time mean on the left-hand side of (3) becomes equal to zero. Thus

$$\overline{\sum p_k \ddot{q}_k} = - \overline{\sum \dot{p}_k \dot{q}_k} \quad . \quad . \quad . \quad . \quad (4)$$

must hold. By (1) and (2) this means that

$$\overline{E_{kin}} = \frac{n+1}{2} \overline{E_{pot}} \quad . \quad . \quad . \quad . \quad (5)$$

If we finally set $n = -2$ (Coulomb force), then Bohr's assertion is valid in its extended form, namely,

$$E_{kin} = - \frac{1}{2} \overline{E_{pot}} \quad . \quad . \quad . \quad . \quad (6)$$

Our theorem does not hold in relativistic mechanics, because here eqn. (1) falls out of action.

6. Some Examples of Integration by Complex Variables

(To Chapter IV, § 6, p. 235; Chapter V, § 7, p. 312, and to the following notes)

It is well known that the method of complex variables has the advantage of allowing integrals over a closed path of integration to be evaluated without the necessity of special devices and almost without

6. Some Examples of Integration by Complex Variables 549

calculation. As we shall see in the next note it is intimately related to the problems of the quantum theory.

(a) Let us first suppose that we are dealing with a *real* integral which allows itself to be regarded directly as a *closed complex* integral :

$$J = \frac{1}{2\pi} \int_0^{2\pi} \frac{d\phi}{1 + \epsilon \cos \phi} \quad \dots \quad (1)$$

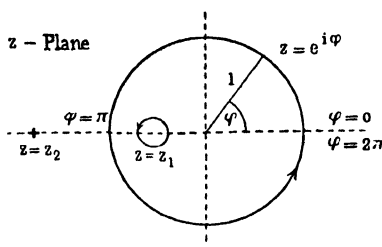

FIG. 123.

We introduce as a new variable the complex quantity $z = e^{i\phi}$ which traverses the unit circle in the positive sense, while ϕ goes from 0 to 2π , cf. Fig. 123. In these variables we write

$$J = \frac{1}{2\pi i} \oint_z \frac{dz}{z \left[1 + \frac{\epsilon}{2} \left(z + \frac{1}{z} \right) \right]} = \frac{1}{\pi i \epsilon} \oint \frac{dz}{z^2 + \frac{\epsilon}{2} z + 1} \quad \dots \quad (2)$$

where

$$\eta = \frac{1}{\epsilon}$$

Since, on account of the meaning of ϵ (numerical eccentricity) and also on account of the convergence of the integral (1) we must assume $\epsilon < 1$, η becomes > 1 . The roots of the denominator in (2) are

$$\left. \begin{aligned} z_1 &= -\eta + \sqrt{\eta^2 - 1} \dots z_1 < 1 \\ z_2 &= -\eta - \sqrt{\eta^2 - 1} \dots z_2 > 1 \end{aligned} \right\} \quad \dots \quad (3)$$

In place of (2) we get by resolving into partial fractions

$$\left. \begin{aligned} J &= \frac{1}{\pi i \epsilon} \oint \frac{dz}{(z - z_1)(z - z_2)} \\ &= \frac{1}{\pi i \epsilon (z_1 - z_2)} \left(\oint \frac{dz}{z - z_1} - \oint \frac{dz}{z - z_2} \right) \end{aligned} \right\} \quad \dots \quad (4)$$

The second of the last two integrals vanishes since its singular point lies outside the unit circle. The first allows itself to be contracted into a path encircling the point $z = z_1$ in the interior of the unit circle and it has the value $2\pi i$. Accordingly,

$$J = \frac{2\pi i}{\pi i \epsilon (z_1 - z_2)} \quad \dots \quad (5)$$

But by (3) we have

$$z_1 - z_2 = 2\sqrt{\eta^2 - 1} = \frac{2}{\epsilon}\sqrt{1 - \epsilon^2}$$

and thus (5) passes over into

$$J = \frac{1}{\sqrt{1 - \epsilon^2}} \quad \dots \quad (6)$$

(b) The following integral allows itself to be reduced to integral (a); we encountered it in the elliptic motion in equ. (13) on p. 235:

$$J_1 = \frac{\epsilon^2}{2\pi} \int_0^{2\pi} \frac{\sin^2 \phi}{(1 + \epsilon \cos \phi)^2} d\phi.$$

For, by partial integration, this becomes

$$J_1 = \frac{\epsilon}{2\pi} \int_0^{2\pi} \frac{\sin \phi}{1 + \epsilon \cos \phi} d\phi - \frac{\epsilon}{2\pi} \int_0^{2\pi} \frac{\cos \phi}{1 + \epsilon \cos \phi} d\phi.$$

The first term on the right vanishes, the second allows itself to be rewritten thus:

$$J_1 = \frac{1}{2\pi} \int_0^{2\pi} \left(\frac{1}{1 + \epsilon \cos \phi} - 1 \right) d\phi = J - 1.$$

So we get

$$J_1 = \frac{1}{\sqrt{1 - \epsilon^2}} - 1 \quad \dots \quad (7)$$

The integral that essentially gives the time of revolution of the elliptic orbit (cf. eqns. (28) and (29) on p. 312), namely,

$$J_2 = \frac{1}{2\pi} \int_0^{2\pi} \frac{d\phi}{(1 + \epsilon \cos \phi)^2} \quad \dots \quad (7a)$$

also allows itself to be reduced to the integral (a).

In (1) and (6) we replace ϵ by ϵ/a and get the following two expressions for J_2/a :

$$\frac{1}{2\pi} \int_0^{2\pi} \frac{d\phi}{a + \epsilon \cos \phi} = \frac{1}{\sqrt{a^2 - \epsilon^2}}$$

By differentiating with respect to a we get:

$$\frac{1}{2\pi} \int_0^{2\pi} \frac{d\phi}{(a + \epsilon \cos \phi)^2} = \frac{a}{(a^2 - \epsilon^2)^{3/2}}$$

If we next set $a = 1$, then J_2 comes out on the left. We thus have

$$J_2 = \frac{1}{(1 - \epsilon^2)^{3/2}} \quad \dots \quad (7b)$$

(c) The integral

$$J_3 = \oint \sqrt{A + \frac{B}{r} + \frac{C}{r^2}} dr. \quad (8)$$

constitutes the natural and general basis for the treatment of the radial quantum condition. The constants A , B , and C have a somewhat different meaning in the relativistic and non-relativistic cases. For the diagram we take them so that the branch points of the integrand—we call them r_{min} and r_{max} , “perihelion- and aphelion-distance”—have real positive values. The path of integration is initially from r_{min} to r_{max} and back again to r_{min} ; as shown in Fig. 124 it is drawn out into a closed course in the complex r -plane. The r -plane is to be supposed slit up between r_{min} and r_{max} and represents the upper sheet of a two-sheeted Riemann surface. On account

of the positive character of the phase-integrals the sign of the square root is to be taken *positive* for a positive dr (section below the slit) and *negative* for a negative dr (section above the slit), as is indicated in the figure.

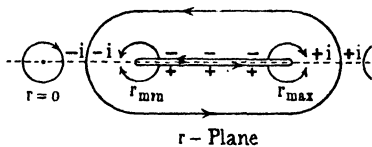

FIG. 124.

From this it immediately follows that the square root on the real axis of the r -plane outside the slit is imaginary, and, indeed, positive and imaginary for $r > r_{max}$, negative and imaginary for $0 < r < r_{min}$, as is likewise indicated in the figure. We recognise this if, starting from the positive or negative edge of the branch section, we make half a revolution around the branch-point $r = r_{max}$ or $r = r_{min}$.

We continue further along the path of integration and close it at the poles of the integrand. These are the points

$$r = 0 \text{ and } r = \infty.$$

At the point $r = 0$, J_3 behaves like

$$\sqrt{C} \int_r dr / \left(1 + \frac{B}{C} r + \dots \right)$$

As the figure shows, the integration is to be made in the sense of the hands of a clock and hence the first member of the series furnishes the value $-2\pi i$; the remaining members, however, vanish in the integration. Hence the total contribution of the point $r = 0$ is

$$-2\pi i \sqrt{C} \quad (9)$$

The point at infinity is indicated in the figure in the finite region. We set

$$s = \frac{1}{r}, \quad dr = -\frac{ds}{s^2},$$

$$J_3 = - \int \sqrt{A + 2Bs + Cs^2} \frac{ds}{s^2} = - \sqrt{A} \int \left(1 + \frac{B}{A}s + \dots \right) \frac{ds}{s^2}.$$

The residue of this integral for the point $s = 0$ is solely determined by the member containing s^{-1} ; this member has for its coefficient

$$-\frac{B}{\sqrt{A}}.$$

The contribution of the point at infinity therefore becomes (cf. the sense of revolution in the figure)

$$+ 2\pi i \frac{B}{\sqrt{A}} \dots \dots \dots (9a)$$

From the sum of (9) and (9a) we get the following value for J_3 , which will be of fundamental importance in the sequel :

$$J_3 = - 2\pi i \left(\sqrt{C} - \frac{B}{\sqrt{A}} \right) \dots \dots \dots (10)$$

We add a supplementary remark about the sign of \sqrt{C} . \sqrt{C} was defined in (8) as the residue of the expression

$$\sqrt{A} \left(\frac{2B}{r} + \frac{C}{r^2} \right)$$

for $r = 0$. This expression is, as has already been indicated in the figure, negative and imaginary in the vicinity of the zero-point where r is real and positive. Hence \sqrt{C} is also to be reckoned *negative and imaginary* in (10). Correspondingly we conclude that \sqrt{A} is positive and imaginary.

(d) In J_3 we add a correction member having the small coefficient D_1 and consider

$$J_4 = \oint \sqrt{A + 2\frac{B}{r} + \frac{C}{r^2} + \frac{D_1}{r^3}} dr \dots \dots \dots (11)$$

The position of the branch point is not essentially altered by the correction member. Hence we may take over the preceding figure with its determinations about signs and path of integration.

To be able to carry out the integration we shall expand the root in power series of the correction member. For this it is necessary to deform the path of integration in given cases in such a way that the expansion is possible along its whole course. For a sufficiently small D_1 this will always be the case. The deformed path of integration must avoid any branch points that may happen to arise from the added correction member. If we now carry out the integration term by term, then we may proceed with each member as in Fig. 124, since in the individual member only the branch incision $r_{min} \rightarrow r_{max}$ and the poles $r = 0$ and $r = \infty$ occur.

If we retain only the first power of D_1 , the expansion runs thus :

$$= \left. \begin{aligned} & \sqrt{A + \frac{2B}{r} + \frac{C}{r^2} + \frac{D_1}{r^3}} \\ & = \sqrt{A + \frac{2B}{r} + \frac{C}{r^2}} + \left(A + \frac{2B}{r} + \frac{C}{r^2} \right)^{-\frac{1}{2}} \cdot \frac{D_1}{2r^3} \end{aligned} \right\} \dots (12)$$

For the integration aimed at in (11) it leads to

$$J_4 = J_3 + \frac{D_1}{2} J_5 \dots \dots \dots (13)$$

$$J_5 = \oint \left(A + \frac{2B}{r} + \frac{C}{r^2} \right)^{-\frac{1}{2}} \frac{dr}{r^3} \dots \dots \dots (14)$$

6. Some Examples of Integration by Complex Variables 553

J_5 behaves regularly at the point $r = \infty$. For if, as above, we set $s = \frac{1}{r}$, then

$$J_5 = - \int \sqrt{A + 2Bs + Cs^2} \cdot s ds$$

At the point $r = 0$ there results

$$J_5 = \int_{r^2}^{dr} (C + 2Br + Ar^2)^{-\frac{1}{2}} = \frac{1}{\sqrt{C}} \int_{r^2}^{dr} \left(1 - \frac{B}{C} \cdot r + \dots\right) \left. \right\} \quad (15)$$

$$= + 2\pi i \frac{B}{C\sqrt{C}}$$

Hence, taking into account (10), we get from (13) that

$$J_4 = - 2\pi i \left(\sqrt{C} - \frac{B}{\sqrt{A}} - \frac{BD_1}{2C\sqrt{C}} \right) \quad (16)$$

(e) In J_4 we add a second correction member with the small factor D_2 , which is, say, of the same order of magnitude as D_1^2 , and let us consider

$$J_6 = \oint \sqrt{A + 2\frac{B}{r} + \frac{C}{r^2} + \frac{D_1}{r^3} + \frac{D_2}{r^4}} dr \quad (17)$$

Here again Fig. 124 serves to inform us in the matter of path of integration and sign. Concerning the fundamental treatment of the path of integration the same is to be said as under (d).

Excluding all powers that are higher than D_1 , D_1^2 , and D_2 , we next expand

$$\begin{aligned} & \sqrt{A + 2\frac{B}{r} + \frac{C}{r^2} + \frac{D_1}{r^3} + \frac{D_2}{r^4}} \\ &= \sqrt{A + 2\frac{B}{r} + \frac{C}{r^2}} + \frac{1}{2} \left(A + 2\frac{B}{r} + \frac{C}{r^2} \right)^{-\frac{1}{2}} \left(\frac{D_1}{r^3} + \frac{D_2}{r^4} \right) \\ & \quad - \frac{1}{8} \left(A + 2\frac{B}{r} + \frac{C}{r^2} \right)^{-\frac{3}{2}} \frac{D_1^2}{r^6}, \end{aligned}$$

and then get

$$J_6 = J_3 + \frac{D_1}{2} J_5 + \frac{D_2}{2} J_7 - \frac{D_1^2}{8} J_8 \quad (18)$$

$$J_7 = \oint \left(A + 2\frac{B}{r} + \frac{C}{r^2} \right)^{-\frac{1}{2}} \frac{dr}{r^4} \quad (19)$$

$$J_8 = \oint \left(A + 2\frac{B}{r} + \frac{C}{r^2} \right)^{-\frac{3}{2}} \frac{dr}{r^6} \quad (20)$$

In calculating J_7 and J_8 we are again concerned only with the point $r = 0$, since the position $r = \infty$ also behaves regularly here. For the neighbourhood of $r = 0$, the following holds:

$$\begin{aligned}
 J_7 &= \int \frac{dr}{r^3} (C + 2Br + Ar^2)^{-\frac{1}{2}} \\
 &= \frac{1}{\sqrt{C}} \int \frac{dr}{r^3} \left[1 - \left(\frac{B}{C}r + \frac{A}{2C}r^2 \right) + \frac{3}{2} \left(\frac{B}{C}r + \frac{A}{2C}r^2 \right)^2 - \dots \right] \\
 &= \frac{1}{\sqrt{C}} \int \frac{dr}{r^2} \left[1 - \frac{B}{C}r - \frac{1}{2} \left(\frac{A}{C} - 3 \frac{B^2}{C^2} \right) r^2 + \dots \right] = \frac{\pi i}{\sqrt{C}} \left(\frac{A}{C} - 3 \frac{B^2}{C^2} \right).
 \end{aligned}$$

Further,

$$\begin{aligned}
 J_8 &= \int \frac{dr}{r^3} (C + 2Br + Ar^2)^{-\frac{3}{2}} \\
 &= \frac{1}{C\sqrt{C}} \int \frac{dr}{r^3} \left[1 - 3 \left(\frac{B}{C}r + \frac{A}{2C}r^2 \right) + \frac{15}{2} \left(\frac{B}{C}r + \frac{A}{2C}r^2 \right)^2 + \dots \right] \\
 &= \frac{1}{C\sqrt{C}} \int \frac{dr}{r^3} \left[1 - 3 \frac{B}{C}r - \frac{3}{2} \left(\frac{A}{C} - 5 \frac{B^2}{C^2} \right) r^2 + \dots \right] \\
 &= \frac{3\pi i}{C\sqrt{C}} \left(\frac{A}{C} - 5 \frac{B^2}{C^2} \right).
 \end{aligned}$$

With these values of J_7 and J_8 , as well as with the values of J_3 and J_5 out of (10) and (15), (18) becomes

$$\begin{aligned}
 J_6 &= -2\pi i \left\{ \left(\sqrt{C} - \frac{B}{\sqrt{A}} - \frac{BD_1}{2C\sqrt{C}} \right) - \frac{D_2}{4C\sqrt{C}} \left(A - 3 \frac{B^2}{C} \right) \right. \\
 &\quad \left. + \frac{3D_1^2}{16C^2\sqrt{C}} \left(A - 5 \frac{B^2}{C} \right) \right\}.
 \end{aligned}$$

By collecting those terms that contain A as a factor, we finally get

$$\left. \begin{aligned}
 J_6 &= -2\pi i \left\{ \sqrt{C} - \frac{B}{\sqrt{A}} - \frac{1}{2} \frac{B}{C\sqrt{C}} \left(D_1 - \frac{3}{2} \frac{D_2 B}{C} + \frac{15}{8} \frac{D_1^2 B}{C^2} \right) \right. \\
 &\quad \left. - \frac{1}{4} \frac{A}{C\sqrt{C}} \left(D_2 - \frac{3}{4} \frac{D_1^2}{C} \right) \right\} \quad (21)
 \end{aligned} \right\}$$

(f) We now return to the integral designated by J_3 in (8) and insert in it a correction member Dr . We shall call the integral resulting from this

$$K = \oint \sqrt{A + 2 \frac{B}{r} + \frac{C}{r^2}} + Dr \, ar. \quad (22)$$

By expanding again in powers of D , we get as the first member the former integral J_3 . We call the integral of the second member K_1 :

$$K = J_3 + \frac{D}{2} K_1, \quad (23)$$

setting, in general,

$$K_n = \oint \sqrt{A + \frac{2B}{r} + \frac{C}{r^2}} = \oint \sqrt{C + 2Br + Ar^2} \quad (24)$$

Here it is the point $r = \infty$ that plays the deciding part, whereas now the integrand is regular at $r = 0$. We introduce the new variable of integration $s = 1/r$ and have

$$K_1 = - \oint \frac{ds}{s^3 \sqrt{\Lambda}} \left(1 + 2\frac{B}{A}s + \frac{C}{A}s^2 \right)^{-\frac{1}{2}}$$

Expanding as far as powers of s^2 within the square brackets, we get

$$K_1 = - \oint \frac{ds}{s^3 \sqrt{\Lambda}} \left[1 - \frac{B}{A}s + \left(\frac{3B^2}{2A^2} - \frac{C}{2A} \right) s^2 + \dots \right]$$

and by contracting the path of integration about $s = 0$

$$K_1 = \frac{2\pi i}{\sqrt{\Lambda}} \left(\frac{3B^2}{2A^2} - \frac{C}{2A} \right) \quad . \quad . \quad . \quad (25)$$

Accordingly, in view of (10), (23) gives

$$K = - 2\pi i \left\{ \sqrt{C} - \frac{B}{\sqrt{\Lambda}} - \frac{D}{4\Lambda^{3/2}} \left(\frac{3B^2}{A} - C \right) \right\} \quad . \quad . \quad (26)$$

In general

$$\left. \begin{aligned} K_n &= - \oint \frac{ds}{s^{n+2} \sqrt{\Lambda}} \left(1 + 2\frac{B}{A}s + \frac{C}{A}s^2 \right)^{-\frac{1}{2}} \\ &= - \frac{2\pi i}{\sqrt{\Lambda}} \operatorname{Res} \frac{\left(1 + 2\frac{B}{A}s + \frac{C}{A}s^2 \right)^{-\frac{1}{2}}}{s^{n+2}} \end{aligned} \right\} \quad . \quad . \quad (27)$$

The following similarly constructed integral is calculated in exactly the same way:

$$K_n' = \oint \frac{r^n dr}{\left(A + \frac{2B}{r} + \frac{C}{r^2} \right)^{\frac{3}{2}}} = \oint \frac{r^{n+3} dr}{(C + 2Br + Ar^2)^{\frac{3}{2}}} \quad . \quad . \quad (28)$$

We get for it

$$K_n' = \frac{2\pi i}{A \sqrt{\Lambda}} \operatorname{Res} \frac{\left(1 + 2\frac{B}{A}s + \frac{C}{A}s^2 \right)^{-\frac{3}{2}}}{s^{n+2}} \quad . \quad . \quad (29)$$

The sign **Res** in (27) and (29) denotes the coefficients of s^{-1} in the power series of the expression that follows it.

7. Hamilton's Partial Differential Equation and the Separation of Variables. The Moduli of Periodicity of the Function of Action as a whole Multiple of Planck's Quantum of Action

(To Chapter IV, § 6, p. 235 and Chapter V, § 4, etc.)

Up to a few years ago it was possible to consider that the methods of mechanics of Hamilton and Jacobi could be dispensed with for physics and to regard it as serving only the requirements of the calculus of astronomic perturbations and the interests of mathematics. Accordingly it is not even touched on in the most famous of German textbooks on mechanics, namely the lectures of Kirchhoff.

Since the appearance of the papers by Schwarzschild and Epstein in the year 1916, which, following immediately on the papers by the author on the fine structure of the Balmer series, link up the quantum conditions with the partial differential equations of mechanics, it seems almost as if Hamilton's method were expressly created for treating the most important problems of physical mechanics.

We start from eqn. (12) on page 543 which was derived from d'Alembert's principle :

$$\sum_{k=1}^{k=f} p_k \delta q_k \Big|_0^t = \int_0^t \delta L d\tau \quad . \quad . \quad . \quad (1)$$

We take the q_k 's as having the meaning, more general than on page 541, of arbitrary positional co-ordinates independent of one another, and the p_k 's as the corresponding momentum co-ordinates. Further, we shall free ourselves from the restriction, introduced for Hamilton's principle on page 545, that the time may not be subjected to variation. Accordingly we set

$$\int_0^t \delta L d\tau = \delta \int_0^t L d\tau - L \delta t$$

and get, instead of (1),

$$\sum_{k=1}^{k=f} p_k \delta q_k \Big|_0^t = \delta \int_0^t L d\tau - L \delta t \quad . \quad . \quad . \quad (2)$$

If we assume that the potential energy does not contain the time and also that the equations of condition that may happen to exist between the parts of the system are independent of t , then the energy law holds in the form

$$H = E_{kin} + E_{pot} = W \quad . \quad . \quad . \quad (3)$$

By using eqn. (13a) on page 543 we may write

$$\int_0^t L d\tau = 2 \int_0^t E_{kin} d\tau - Wt = S - Wt \quad . \quad . \quad . \quad (4)$$

The quantity

$$S = 2 \int_0^t E_{kin} d\tau \quad . \quad . \quad . \quad (5)$$

here introduced is called the *function of action*.

If we insert (4) in (2), it follows that

$$\left. \begin{aligned} \sum p_k \delta q_k \Big|_0^t &= \delta S - t \delta W - (W + L) \delta t \\ &= \delta S - t \delta W - \sum p_k \dot{q}_k \cdot \delta t \end{aligned} \right\} \quad . \quad . \quad . \quad (6)$$

In the latter method of rewriting the right-hand side we have used

$$W + L = 2E_{kin} = \sum p_k \dot{q}_k$$

[cf. eqn. (5) on p. 541].

The integral (5) is to be taken over any mechanically possible path, as is shown by its derivation from d'Alembert's principle. Through fixing such a path by means of its initial conditions (initial position and initial momentum) S becomes a definite function of the time. By making the initial conditions variable, S appears as a function of $2f + 1$ variables (of the time, of f co-ordinates q_k^0 of the initial position and of f co-ordinates p_k^0 of the initial momentum). But instead of these $2f + 1$ variables we shall introduce other variables, namely (proceeding as for a ballistic problem), besides the co-ordinates q_k^0 of the initial point, the co-ordinates q_k of the end-point ("target point"; "Treffpunkt") and, simultaneously, instead of the time t between the initial point and the target point, the energy W (in ballistic terms, the "charge"). As a matter of fact, starting from a given initial point, we can reach a given target point by different paths and in various orbital times, according to the amount of energy available. The equation that accordingly exists between t , W , q_k and q_k^0 allows us to calculate t as a function of W , q_k and q_k^0 and to eliminate it by inserting this value in the upper limit of S . *In the sequel we accordingly regard S , the function of action, as a function of the co-ordinates q_k of the final position and of the co-ordinates q_k^0 of the initial position, and as a function of the energy W . We take δS as standing for the expression*

$$\delta S = \sum \frac{\partial S}{\partial q_k} \delta q_k + \sum \frac{\partial S}{\partial q_k^0} \delta q_k^0 + \frac{\partial S}{\partial W} \delta W \quad . \quad . \quad (5a)$$

We suppose this value of δS inserted in the right-hand side of eqn. (6). Designating the displacements δq_k for $t = 0$ and $t = t$ on the left-hand side of (6) by δq_k^0 and δq_k^t , we write in place of (6)

$$\sum_{k=1}^{k=f} p_k (\delta q^t + \dot{q}_k \delta t) - \sum_{k=1}^{k=f} p_k^0 \delta q_k^0 + t \delta W = \delta S \quad . \quad . \quad (6a)$$

Let the quantity δq_k^t be called the "variation at the final point of the orbit." It signifies the virtual displacement to which we have subjected the orbital element at the time $\tau = t$. We must distinguish between this and the "variation of the end-point of the orbit," which, as in eqn. (5a), will be called δq_k . The latter is now composed of two parts; (1) of the virtual displacement δq_k^t that we have effected at the end of the orbit, and (2) of the lengthening of the orbit which corresponds to the alteration of the orbital time by the amount δt . We have to imagine the co-ordinate q_k to continue its course during the time δt with the velocity \dot{q}_k . The second part therefore becomes $\dot{q}_k \delta t$ and we have

$$\delta q_k = \delta q_k^t + \dot{q}_k \delta t.$$

If we insert this in the left-hand side of (6a) the following relation results, on which all that follows is founded,

$$\sum_{k=1}^{k=f} p_k \delta q_k + \sum_{k=1}^{k=f} p_k^0 \delta q_k^0 + t \delta W = \delta S \quad . \quad . \quad (7)$$

(where δq_k is the variation of the end-point of the orbit).

By the rule on page 201, about the integration limits of the phase-integral, J_k denotes the increase that S undergoes when the variable q_k traverses the region that comprises the complete description of all the phases of motion of the system. Fixing our attention on periodic motions (or "conditionally periodic" motions, see below), we represent to ourselves that in the integration q_k returns to its value at the outset and we call J_k the *kth modulus of periodicity of the function of action*. Our quantum conditions

$$\int p_k dq_k = n_k h$$

then require that the *moduli of periodicity of the action function be whole multiples of Planck's quantum of action*.

To see how the moduli of periodicity of S are determined we must consider a little more closely the integration of the differential eqn. (10). The only method that is successful is that of the *separation of variables*. We shall illustrate it by a simple example.

Suppose we are dealing with an oscillator bound anisotropically in space. The restoring forces $-k_1x_1, -k_2x_2, -k_3x_3$ act on the point-mass m in the directions of three mutually perpendicular axes $x_1x_2x_3$. If p_1, p_2, p_3 , are the components of momentum ($p_k = m\dot{x}_k$), then

$$E_{kin} = \frac{p_1^2}{2m} + \frac{p_2^2}{2m} + \frac{p_3^2}{2m}, \quad E_{pot} = \frac{1}{2}(k_1x_1^2 + k_2x_2^2 + k_3x_3^2)$$

and the partial differential eqn. (10) then becomes :

$$\left(\frac{\partial S}{\partial x_1}\right)^2 + \left(\frac{\partial S}{\partial x_2}\right)^2 + \left(\frac{\partial S}{\partial x_3}\right)^2 + m(k_1x_1^2 + k_2x_2^2 + k_3x_3^2) = 2mW \quad (13)$$

This equation allows itself to be "separated" with respect to the variables $x_1x_2x_3$, that is, it allows itself to be resolved into the following three equations, that each depend on only one of the three variables :

$$\left. \begin{aligned} \left(\frac{\partial S}{\partial x_1}\right)^2 + mk_1x_1^2 &= a_1, & \left(\frac{\partial S}{\partial x_2}\right)^2 + mk_2x_2^2 &= a_2, \\ \left(\frac{\partial S}{\partial x_3}\right)^2 + mk_3x_3^2 &= a_3 \end{aligned} \right\} \quad (14)$$

where a_1, a_2, a_3 are integration constants between which the following relation holds :

$$a_1 + a_2 + a_3 = 2mW \quad . \quad . \quad . \quad (15)$$

We thus have only two arbitrary constants; the third constant is determined by these two and W .

Eqns. (14) give us

$$\frac{\partial S}{\partial x_i} = \sqrt{a_i - mk_ix_i^2} = \sqrt{mk_i} \sqrt{a_i^2 - x_i^2} \quad . \quad . \quad (16)$$

Here we have set

$$a_i = mk_i\alpha_i^2 \quad . \quad . \quad . \quad (17)$$

Eqn. (16) shows in conjunction with the mechanical meaning of

$$\frac{\partial S}{\partial x_i} = p_i = m\dot{x}_i \quad . \quad . \quad . \quad (18)$$

that the variable x_i is limited to the region between $\pm a_i$ and that it can reverse its sense of motion only at the end-points $\pm a_i$ of this region. For if x_i were to overstep the region $\pm a_i$, then p_i would become imaginary, which is impossible. If x_i were to stop before getting to the boundaries of the region and reverse its direction at a point inside, then \dot{x}_i would = 0 here; but by (18) this would entail the vanishing of $\partial S/\partial x_i$, which is excluded by (16), since $\partial S/\partial x_i$ can vanish only at the limiting points $\pm a_i$. Thus *the variable x_i traverses the entire region $\pm a_i$ alternately in the increasing and the decreasing sense, reversing its sense of motion and the sign of p_i at the end-points of the region.* That is, the full region of variability of x_i stretches from $-a_i$ to $+a_i$ and back again to $-a_i$. We indicate this integration by adding a circle \bigcirc to the integral sign. Our quantum conditions are then to be written in the form

$$J_i = \oint_{\bigcirc} \frac{\partial S}{\partial x_i} dx_i = \sqrt{mk_i} \oint \sqrt{a_i^2 - x_i^2} dx_i = n_i h . \quad (19)$$

Here the integral obviously denotes the circular surface whose radius is a_i . Thus we conclude from (19) that

$$a_i^2 = \frac{n_i h}{\pi \sqrt{mk_i}} . \quad (20)$$

From (17) and (15) it then follows that

$$a_i = \sqrt{mk_i} \frac{n_i h}{\pi}, \quad \sum \sqrt{mk_i} \frac{n_i h}{\pi} = 2mW . \quad (21)$$

We finally introduce the vibration numbers ν_i , which correspond to the free oscillations of our point-mass in the three co-ordinate directions. These are given by

$$2\pi\nu_i = \sqrt{\frac{k_i}{m}}, \quad \sqrt{mk_i} = 2\pi m\nu_i.$$

If we insert this in the second equation (21), we get

$$2mW = \sum 2m\nu_i n_i h, \quad W = \sum \nu_i n_i h . \quad (22)$$

The energy of our oscillator thus appears, as was to be foreseen, as an integral sum of energy-quanta $h\nu_i$ that correspond to the three partial vibrations; our spatial oscillator, just like the linear oscillator in Chapter IV, § 1, is quantised according to energy-elements.

A series of general remarks follow from this simple example.

(a) If Hamilton's differential equation of a system of f degrees of freedom allows itself to be fully separated as regards the co-ordinates $q_1 . . . q_f$, that is, divided into parts that depend in turn on only one of the co-ordinates q_i , then, as in (14), f constants a_i appear, of which, however, only $f - 1$ are arbitrary. In this way we obtain by the method of separation of variables the complete solution of Hamilton's differential equation with the number of integration constants required in our former remarks. Together with the energy-constant W we have f parameters (we shall call them briefly the "constants a "), which according to classical mechanics, may be chosen freely within a continuous manifold, but, according to the quantum theory, are capable only of discrete values.

to be purely formal. In reality, there is, according to Epstein, a sound geometrical meaning.

In the conditionally periodic motions, the envelopes of the orbit are the co-ordinate surfaces $q_i = a_i$ or, respectively, $q_i = b_i$, corresponding to the straight lines $x_1 = \pm a_1$, and $x_2 = \pm a_2$, in Fig. 125; these surfaces occur in the f -dimensional space. Now if we change the integration constants a_i , the surface configuration contracts or expands and in this way defines the whole system of co-ordinate surfaces $q_i = \text{const}$. Thus in the conditionally periodic system the correct co-ordinates to be used in the quantum conditions are not only distinguished formally by admitting the possibility of separation, but also mechanically and geometrically as the envelopes of the orbit. *The conditionally periodic systems furnish their correct co-ordinate system of themselves.* Conversely, if the orbit has a system of enveloping surfaces, and if the parameters of these surfaces are chosen as co-ordinates, it is to be presumed that the Hamilton equation will allow itself to be separated with respect to them. We here merely remark in passing that under some circumstances the separation of the differential equation must be effected not by a mere change of the co-ordinates q_i but by a simultaneous change of the co-ordinates p_i and q^i (contact transformation).

(h) But what of the case when the Hamiltonian differential equation allows itself to be separated with respect to *two* different systems of co-ordinates? Which of these systems is then the correct one? In one sense the answer is "neither," in another, "both."

To get a general survey of the conditions here involved, it is worth returning to the example of the harmonic oscillator and to assume that two of its bonds become equal. For example, let $k_1 = k_2 = k$, then also $\nu_1 = \nu_2 = \nu$. Eqn. (13) then takes the following form if we introduce in place of the rectilinear co-ordinates x_1, x_2 the polar co-ordinates r, ϕ :

$$\left(\frac{\partial S}{\partial r}\right)^2 + r^2\left(\frac{\partial S}{\partial \phi}\right)^2 + \left(\frac{\partial S}{\partial x_3}\right)^2 + m(kr^2 + k_3 x_3^2) = 2mW.$$

It also allows itself to be separated with respect to these co-ordinates according to the scheme:

$$\frac{\partial S}{\partial \phi} = p, \quad \left(\frac{\partial S}{\partial r}\right)^2 + \frac{p^2}{r^2} + mkr^2 = a, \quad \left(\frac{\partial S}{\partial x_3}\right)^2 + mk_3 x_3^2 = a_3,$$

in which the relation

$$a + a_3 = 2mW. \quad . \quad . \quad . \quad . \quad (27)$$

which is analogous to (15), must hold between a and a_3 .

This ambiguity of the co-ordinate system is in very good agreement with the remarks contained in (g). When the vibration numbers are equal for the directions 1 and 2, the projection of the orbital curve on the plane $x_1 x_2$ is not a general Lissajous curve, but a closed ellipse whose centre is the origin of co-ordinates. Hence, according to the standpoint adopted in (g) we can recognise neither of these two co-ordinate systems, x_1, x_2 or r, ϕ as the natural and correct system. In the third co-ordinate x_3 , however, the Lissajous character of the orbit remains preserved, so long as ν_3 differs from ν (and so long as ν_3 is not a rational multiple of ν , cf. below). For example, the projection of the orbit on to the plane

x_1, x_3 again offers the picture of Fig. 125. In terms of space the orbit in this case everywhere closely covers the mantle of an elliptic cylinder. (In the general case, on the other hand, it fills the whole interior of a spatial parallelepiped. If finally $\nu_1 = \nu_2 = \nu_3$, the orbit degenerates into a single spatial ellipse that is unceasingly traversed.) For the co-ordinates r, ϕ, x_3 the quantum conditions would be

$$\left. \begin{aligned} 2\pi p &= nh, & J_r &= \oint \sqrt{a - mkr^2 - \frac{p^2}{r^2}} dr = n'h \\ J_\phi &= \frac{\pi a_3}{\sqrt{mk_3}} = n_3 h \end{aligned} \right\} \quad (28)$$

The first of these is identical with eqn. (25), the last with eqns. (19) and (17). The middle one allows itself to be reduced by a simple substitution to the form of eqn. (8) in Note 6 and, when worked out, gives us:

$$\sqrt{mk} = (2n' + n)h \quad (29)$$

It now follows from (27), (28) and (29) that the energy is

$$2mW = \frac{\sqrt{mk}}{\pi} (2n' + n)h + \frac{\sqrt{mk_3}}{\pi} n_3 h,$$

or also, according to the meaning of the vibration numbers ν and ν_3 (since $2\pi\nu = \sqrt{k/m}$, $2\pi\nu_3 = \sqrt{k_3/m}$):

$$W = (2n' + n)h\nu + n_3 h\nu_3.$$

Thus for the energy the result is the same as it would be by eqn. (22) if we were to base our calculation on the rectilinear co-ordinates x_1, x_2, x_3 :

$$W = (n_1 + n_2)h\nu + n_3 h\nu_3.$$

In both cases the energy, as it should do, comes out as an integral multiple of the energy-elements $h\nu$. Since, for spectral applications, we are primarily interested in the energy and since this is not affected by the ambiguity, we may, on the other hand, say: both co-ordinate systems x_1, x_2 and r, ϕ are equally admissible for the quantising of the energy.

The unique determination of the co-ordinates must also be regarded with doubt even in those cases in which ν_1 is not indeed equal to ν_2 , but in which $s_1\nu_1 = s_2\nu_2$, where s_1, s_2 denote integers. For then the Lissajous curve becomes closed after s_1 vibrations in the direction 1 and s_2 vibrations in the direction 2. Thus true envelopes do not come into consideration in this case either, since, owing to the finite number of the points of the orbit at which reversion of motion takes place, the straight lines $x_1 = \text{const.}$, $x_2 = \text{const.}$ are not yet defined geometrically as in Fig. 125.

(i) We follow Schwarzschild* and call the exceptional case considered *degenerate*. A degenerate case thus occurs when the Hamiltonian equation allows itself to be separated in various ways and hence when the quantum conditions are not uniquely determined. The geometrical criterion for

* Berlin Academy, Sitzungsber, 1916, p. 548.

this is that in the space of the co-ordinates $q_1 \dots q_f$, the orbit fills a region of less than f -fold power and hence does not as in the general case define f enveloping surface-pairs. But first we shall introduce the conception of *degenerate cases* analytically according to Schwarzschild by starting from the angular co-ordinates that are generally used in astronomy.

To arrive at a general definition of angle co-ordinates we ask ourselves whether it is not possible to describe the motion of a conditionally periodic system by means of "cyclic co-ordinates" alone. A cyclic co-ordinate is (cf. (d) of this note) one such that it does not occur in the expression for the energy and that consequently its corresponding momentum co-ordinate remains constant during the motion. According to this, "cyclic co-ordinates" are "(force-)free co-ordinates" and this characterises their appropriateness for describing the progress of the motion. The simplest example of such a co-ordinate is given by the angle traversed about an axis for which the moment of the forces is zero. On account of this analogy we shall hereafter say instead of cyclic or free co-ordinates "angular co-ordinates," although it is not really the angle (which is increasing irregularly in time) but the surface swept out by the radius vector, that we have to fix our attention on as the analogon to the general definition of angular co-ordinates. Actually it is *the linear progress in time, besides the cyclic or free character*, that constitutes the definition of the angular co-ordinates.

We next show that we arrive at the desired angular co-ordinates in the sense of this postulate *if we introduce our phase-integrals J_k as momentum co-ordinates and seek out the position-co-ordinates that are conjugate to them*. To give the proof we have to base our argument on the scheme of contact transformations.

In a conditionally periodic system the J_k 's are pure functions of the constants α_k and W (they are independent of the remaining constants that enter into the equation of the orbit and that we shall denote by β_k). Thus, we may express the α 's by the J 's and insert them in eqn. (11). This equation then becomes

$$S = S(q_1 \dots q_f, J_1 \dots J_f) \quad . \quad . \quad . \quad (30)$$

and gives us

$$\delta S = \sum \frac{\partial S}{\partial q_k} \delta q_k + \sum \frac{\partial S}{\partial J_k} \delta J_k \quad . \quad . \quad . \quad (31)$$

If we here substitute p_k for $\frac{\partial S}{\partial q_k}$ according to eqn. (8) and introduce the symbol

$$w_k = \frac{\partial S}{\partial J_k} \quad . \quad . \quad . \quad (32)$$

which for the present is to be regarded only as an abbreviation, for $\frac{\partial S}{\partial J_k}$ (31) becomes

$$\delta S = \sum p_k \delta q_k + \sum w_k \delta J_k \quad . \quad . \quad . \quad (33)$$

We read from (33) that the criterion of a contact transformation, and indeed of one of the form (22b) on page 546, is fulfilled for the transition

$p, q \rightarrow J, w$ so long as we define w by (32). The new variables J, w were denoted earlier by P, Q ; our function of action S is there represented by the function F^* , and the case we are dealing with is the special one in which F^* is independent of t , that is, eqn. (22a) on page 546 assumes the form $\bar{H} = H$. Over and above this, our present eqn. (32) shows itself to be identical with the earlier eqn. (22c). According to the theory of contact transformations the Hamiltonian equations hold for the new variables w, J . Now, Hamilton's function $\bar{H} = W$ (just like the remaining integration constants α_k) is a prime function of the J 's, that is, it is independent of the w 's and is constant during the course of the motion. Accordingly we have

$$\frac{dJ_k}{dt} = - \frac{\partial H}{\partial w_k} = 0, \quad \frac{dw_k}{dt} = \frac{\partial H}{\partial J_k} = \text{const.} \quad (34)$$

The first equation states nothing new. It only confirms the constancy of the J_k 's and this is identical with the fact that they can be calculated from the α_k 's. But the second equation states that the w_k 's are *actually the angular co-ordinates that we are seeking*, since they increase uniformly with the time, as we postulated in our definition of angular co-ordinates. If we denote the constant on the right-hand side by ν_k , then we have

$$w_k = \nu_k t + \delta_k \quad (35)$$

The symbol ν_k is to indicate that ν_k plays the part of a constant *vibration number* for the cyclic co-ordinate w_k .

We next show that *every angular co-ordinate w_k increases by 1 whenever the co-ordinate q_k swings once to and fro between its libration limits*.

If we allow the co-ordinate q_k to make a full but otherwise arbitrary revolution within its region of values whilst the remaining q_i 's are kept fixed, then the function of action S changes by the amount of its modulus of periodicity J_k [cf. eqns. (12) or (26)]. Hence, if we denote the initial and the end points of the closed revolution by a and e , that is, two points given by equal values of all the q 's, the relation:

$$S_e - S_a = J_k \quad (36)$$

holds. If we imagine S , as in eqn. (30), to be a function of the q 's and the J 's, we can differentiate (36) partially with respect to J_k , keeping the remaining J 's and all the q 's fixed, and we get, in consequence of (32),

$$w_{ke} - w_{ka} = 1, \quad w_{ie} - w_{ia} = 0, \quad i \neq k \quad (37)$$

Thus if the co-ordinate q_k returns to its point of departure after a full revolution, all the remaining q_i 's retaining their values, the corresponding angular co-ordinate w_k increases by 1, whilst the values of the remaining angular co-ordinates remain preserved. And conversely: if one of the angular co-ordinates increases by 1 whilst all the remaining angular co-ordinates keep the same values, the co-ordinates q return to their point of departure. *The q 's are periodic functions of the angular co-ordinates and have the period 1.*

The "modified function of action" S^* has the same property of periodicity as that possessed by q . We define S^* from the function of action S as follows:

$$S^* = S - \sum w_k J_k \quad (38)$$

For if we allow w_k to increase by 1 in the sense of eqn. (37) but make all the other w_i 's return to their point of departure, $\Sigma w_k J_k$ alters by J_k . Then it follows from eqn. (38) that in this change of the w 's the simultaneous change of S^* is equal to that of S , diminished by J_k . Since, by eqn. (36), the change of S was equal to J_k , the change of S^* becomes equal to 0. *Whereas the function of action S has, as a function of the w 's, the additive moduli of periodicity J_k , the modified function of action S^* becomes a pure periodic function of the w 's with the period 1.*

From the periodicity of the q 's it follows immediately that the latter allow themselves to be developed as functions of the w 's in an f -fold infinite Fourier series of the following form :

$$q_i = \left(\sum \right)' C_{s_1 s_2 \dots s_f}^i e^{2\pi i(s_1 w_1 + s_2 w_2 + \dots + s_f w_f)} . . . \quad (39)$$

The C 's are constant co-efficients, that is, they depend only on the integration constants J_k , or, in the language of quanta, only on the integral quantum numbers n_k . The time appears only in the w_k 's, and indeed linearly. The summations in the s_1, s_2, \dots, s_f stretch from $-\infty$ to $+\infty$. After what we have said, the corresponding representation of course also holds for S^* . If we insert the expression (35) for the w 's in (39), it follows that

$$q_i = \left(\sum \right)' D_{s_1 s_2 \dots s_f}^i e^{2\pi i(s_1 v_1 + s_2 v_2 + \dots + s_f v_f)t} . . . \quad (40)$$

in which the co-efficients have the following meaning :

$$D_{s_1 s_2 \dots s_f}^i = C_{s_1 s_2 \dots s_f}^i e^{2\pi i(s_1 \delta_1 + s_2 \delta_2 + \dots + s_f \delta_f)} . . . \quad (41)$$

The dependence of q on the time is, in contrast with that of the angular co-ordinates, *not periodic* ; rather, it is of the *conditionally periodic* type. In general the current point of the orbit never returns strictly to its starting-point ; and in general also the individual co-ordinate q_k does not assume its initial value in periodically equal intervals of time. The single factor

$$e^{2\pi i s_k v_k t}$$

does indeed seem to exhibit the period $\tau_k = 1/v_k$, but the juxtaposition of f different factors of this sort and the irrationality of v_k on the whole disturbs this periodicity from coming about. Our example of the Lissajous motion was distinguished by the fact that each co-ordinate in it, regarded separately, was completely periodic in time (thanks to the circumstance that in this case the infinite Fourier series became reduced for each co-ordinate to a single member). But here, too, the character of the motion as a whole is completely aperiodic, as Fig. 125 shows, *except when several of the Lissajous vibration numbers v become severally equal or commensurable with one another.*

We are now in a position to formulate in exact terms Schwarzschild's definition of degenerate systems. The general case of non-degeneration occurs when all the vibration numbers v_k that are present in the equations of definition (35) of the angular co-ordinates are incommensurable with

one another. *The exceptional case of degeneration occurs when one or more relations of the form*

$$s_1 r_1 + s_2 r_2 + \dots = 0 \quad (42)$$

are fulfilled, s denoting integral coefficients. The case in which, in particular, two of the r 's become equal to each other is clearly included in eqn. (42). If n such relations hold, then the orbit does not, as in the f -dimensional space of the $q_1 \dots q_f$, fulfil an f -fold continuum in general, but only an $(f - n)$ -fold continuum. In this case, we may speak of n -fold degeneration. Compare with this what was said in (h) about the Lissajous curves for which some of the r 's are equal. Complete degeneration occurs in the case of a completely periodic orbit: then $f - 1$ relations of the form (42) must hold or, in particular, all the r_k 's must be equal to one another.

(k) Hitherto we have disregarded the real problem of integration of the differential equations of mechanics, that is, the representation of the motion in its dependence on time, and have shown only that in angular co-ordinates and for conditionally periodic systems, it is reducible to the general Fourier scheme (39). We must now supplement our remarks by a few statements about the method of calculating the orbits that constitutes the true achievement of Jacobi in this field. This is done most briefly by again founding our remarks on the theory of contact transformations. We start out from the integral (11) of the Hamilton-Jacobi equation with the integration constants $W, a_2, a_3 \dots a_f$ (we shall in future continue to omit the unessential constant a_1) and perform the process of variation on it, obtaining

$$\delta S = \sum_1^f \frac{\partial S}{\partial q_k} \delta q_k + \frac{\partial S}{\partial W} \delta W + \sum_2^f \frac{\partial S}{\partial a_k} \delta a_k.$$

Using eqn. (8), we write this

$$\delta S = \sum p_k \delta q_k + \beta_1 \delta W + \sum_2^f \beta_k \delta a_k \quad (43)$$

The quantities β here introduced are, to be defined thus, as a comparison with the preceding equation shows:

$$\beta_1 = \frac{\partial S}{\partial W}, \quad \beta_k = \frac{\partial S}{\partial a_k}, \quad k = 2 \dots f \quad (44)$$

Eqn. (43) states that between the q_k, p_k as original variables, and the β_k, a_k (with $a_1 = W$) as "new variables," the characteristic relation of contact transformation again holds, and indeed in the form of eqn. (22b) on page 546. The function F^* that occurred there is here again represented by S . As it does not contain t explicitly, eqn. (22a) on page 546 assumes the form $\Pi(p, q) = H(P, Q)$, that is, in our case

$$\Pi(p, q) = H(W, a_2 \dots a_f, \beta_1 \dots \beta_f) = W$$

From this it follows that

$$\frac{\partial H}{\partial W} = 1, \quad \frac{\partial H}{\partial a_k} = 0, \quad k = 2 \dots f, \quad \frac{\partial H}{\partial \beta_k} = 0, \quad k = 1 \dots f. \quad (45)$$

Now the Hamiltonian equations hold in the new co-ordinates, W, α, β , just as much as in the old co-ordinates p, q . Thus, in view of (45), we have

$$\begin{aligned} \frac{dW}{dt} &= \frac{\partial H}{\partial \beta_1} = 0, & \frac{d\beta_1}{dt} &= \frac{\partial H}{\partial W} = 1, & \frac{d\alpha_k}{dt} &= \frac{\partial H}{\partial \beta_k} = 0 \\ k &= 2 \dots f, & \frac{d\beta_k}{dt} &= \frac{\partial H}{\partial \alpha_k} = 0, & k &= 2 \dots f. \end{aligned}$$

These equations assert nothing new as far as W and α_k are concerned. They only confirm their constancy during the course of the motion. But concerning β_k they state that *the quantities $\beta_2 \dots \beta_f$ are also constant during the motion and that β_1 becomes equal to t (except for an additive constant, which we can include in the reckoning of the time).* If we now compare this result with the equation of definition (44) of the β 's or, what comes to the same thing, if we use eqn. (22c) on page 546, we have

$$t = \frac{\partial S}{\partial W} \dots \dots \dots (46)$$

$$\beta_k = \frac{\partial S}{\partial \alpha_k} = \text{const.}, \quad k = 2, 3, \dots f \dots \dots (47)$$

Eqns. (47) give $f - 1$ relations between the co-ordinates $q_1 \dots q_f$ of the orbit which do not contain the time. They suffice to describe the *form of the orbit*. We call them the *orbital equations*. The constants $\beta_2 \dots \beta_f$, together with the α_k 's and W , give the still wanting integration constants of the problem. The course of the motion in time is represented by eqn. (46). We call this equation the *time equation*. It may also be read off directly from our initial eqn. (7), if we set $\delta q_k = \delta q_k^0 = 0$ in it.

We have thus deduced --by the shortest way--the remarkable theorem of Jacobi: *the integrals of the equations of motion may, if a complete solution S of the partial differential equations is known, be obtained by mere differentiation.*

8. Quantising of Elliptic Motion by the Method of Separation of Variables

(To Chapter IV, § 6, p. 236)

The method of the preceding note leads astonishingly quickly to the main result in the treatment of elliptic orbits, namely to eqn. (20) on page 236.

$$W = - \frac{2\pi^2 mc^2 F^2}{h^2} \frac{1}{(n + n')^2} \dots \dots \dots (1)$$

Whereas in the discussion of the text in Chapter IV, diverse subsidiary calculations were made and special ideas were developed concerning the orbital curve, the present method proceeds* directly towards its goal, eqn. (1), and reaches it with a minimum of calculation and reasoning.

We take over from eqns. (15) and (16) on page 236 the expressions for

the kinetic and potential energy during the Kepler motion and get for their sum

$$W = E_{kin} + E_{pot} = \frac{1}{2m} \left(p_r^2 + \frac{1}{r^2} p_\phi^2 \right) - \frac{eE}{r}.$$

On account of

$$p_r = \frac{\partial S}{\partial r}, \quad p_\phi = \frac{\partial S}{\partial \phi}$$

the Hamilton-Jacobi differential equation becomes

$$\left(\frac{\partial S}{\partial r} \right)^2 + \frac{1}{r^2} \left(\frac{\partial S}{\partial \phi} \right)^2 = 2mW + \frac{2mcE}{r}. \quad (2)$$

Since ϕ does not occur explicitly (cyclic co-ordinate), we may next set

$$\frac{\partial S}{\partial \phi} = \text{const.} = p. \quad (3)$$

The quantum condition

$$J_\phi = \int_0^{2\pi} \frac{\partial S}{\partial \phi} d\phi = nh \quad (4)$$

therefore gives us for the value of p

$$2\pi p = nh, \quad \frac{\partial S}{\partial \phi} = \frac{nh}{2\pi}. \quad (5)$$

By substitution in (2) there follows

$$\left(\frac{\partial S}{\partial r} \right)^2 = 2mW + \frac{2mcE}{r} - \frac{n^2 h^2}{4\pi^2 r^2}$$

or

$$\frac{\partial S}{\partial r} = \sqrt{A + \frac{2B}{r} + \frac{C}{r^2}} \quad (6)$$

where we have used the abbreviations:

$$A = 2mW, \quad B = mcE, \quad C = -\frac{n^2 h^2}{4\pi^2}.$$

We need not waste time with the general integration of S , but form

$$J_r = \oint \frac{\partial S}{\partial r} dr = n'h. \quad (7)$$

directly. Our method of writing the integral denotes that we wish to apply complex integration and that the path of integration is to be looped around the points r_{min} and r_{max} (cf. Fig. 124). We take the result of the integration from eqn. (10, Note 6:

$$J_r = \oint \sqrt{A + \frac{2B}{r} + \frac{C}{r^2}} dr = -2\pi i \left(\sqrt{C} - \sqrt{A} \right) \quad (8)$$

If we insert this in (7), then, on account of the meaning of A, B, and C, we get

$$-2\pi i \left(-\frac{nh}{2\pi} - \frac{meE}{\sqrt{2mW}} \right) = n'h \quad (9)$$

In determining the sign of \sqrt{C} the concluding remark of Note 6c is to be taken into account. Eqn. (9) now resolves into

$$\frac{2\pi imeE}{\sqrt{2mW}} = (n + n')h$$

or

$$W = -\frac{2\pi^2 me^2 E^2}{h^2} \frac{1}{(n + n')^2} \quad (10)$$

which was to be proved. It cannot be denied that this process is perfectly adapted to the problem.

Only *one* doubt may yet trouble us, that of the uniqueness of the co-ordinates: are the polar co-ordinates r, ϕ the only variables into which eqn. (2) allows itself to be separated? Do other co-ordinates, if there are any such, lead to the same result, to eqn. (1)?

The first question is to be answered in the negative. We see in the treatment of the Stark effect in Chapter V that by the introduction of so-called parabolic co-ordinates the partial differential equation of the Kepler problem for the case in which an external field is present (and hence also for the case in which it is absent) allows itself to be separated. The quantum conditions that we get in these co-ordinates and the quantised orbits that result from them, are different from those obtained in polar co-ordinates. The main result of our treatment, however, remains valid, namely the expression for the energy when quantised in parabolic co-ordinates has the same form as in polar co-ordinates. (Cf. with these remarks pp. 284, 285 and 287.)

The ambiguity vanishes if we treat the problem more fully, that is, if we take into consideration the relativistic variability of electronic mass (cf. Note 16). For this problem polar co-ordinates are prescribed by its very nature. Now, as we have to regard ordinary mechanics as the limiting case of relativistic mechanics, we may also claim our treatment of the Kepler problem in polar co-ordinates as a legitimate limiting case of the complete and unambiguous relativistic solution of the problem.

Even the form of the orbital curve in the classical and relativistic case points to the fact that in the one case we are dealing with a *degenerate*, in the other with a *non-degenerate*, problem [cf. the previous note under the headings (g), (h) and (i)]. The ordinary Kepler-ellipse being a closed orbit has no envelope. Through its enveloping circles the relativistic Kepler ellipse (cf. Fig. 110) defines the co-ordinate r as the correct and uniquely determinate quantum co-ordinate; the azimuth ϕ , being a cyclic co-ordinate of the problem, is in any case mechanically distinguished.

9. The Spherical Wave and its Moment of Momentum

(To Chapter V, § 1, p. 256)

The solution of Maxwell's equations for a vacuum :

$$\text{I. } \frac{1}{c} \dot{\mathbf{H}} = - \text{curl } \mathbf{E}, \quad \text{II. } \frac{1}{c} \dot{\mathbf{E}} = \text{curl } \mathbf{H}$$

may be reduced, by extending them by means of a supplementary term due to Hertz, to determine a "Hertz vector" Π . We set

$$\mathbf{E} = \text{curl curl } \Pi, \quad \mathbf{H} = \frac{1}{c} \text{curl } \dot{\Pi} \quad . \quad . \quad . \quad (1)$$

which satisfy II. Eqn. (1) then transforms into

$$\text{curl} \left(\frac{1}{c^2} \ddot{\Pi} + \text{curl curl } \Pi \right) = 0 \quad . \quad . \quad . \quad (2)$$

If we use rectilinear co-ordinates we know that

$$\text{curl curl } \Pi = \text{grad div } \Pi - \Delta \Pi \quad . \quad . \quad . \quad (3)$$

Since $\text{curl grad} = 0$, we may also write (2) in the form :

$$\text{curl} \left(\frac{1}{c^2} \ddot{\Pi} - \Delta \Pi \right) = 0.$$

This equation is satisfied if we subject Π to the condition expressed in the vibration equation

$$\frac{1}{c^2} \ddot{\Pi} = \Delta \Pi \quad . \quad . \quad . \quad (4)$$

We write that solution of this equation, which corresponds to a monochromatic spherical wave $r = 0$ (a simple dipole) in the form :

$$\Pi = \mathbf{P} \frac{e^{ikr}}{r}, \quad \mathbf{P} = \mathbf{p} e^{-i\omega t}, \quad \mathbf{p} = \begin{cases} p_x = ae^{i\alpha} \\ p_y = be^{i\beta} \\ p_z = ce^{i\gamma} \end{cases} \quad . \quad . \quad (5)$$

Here $k = \frac{\omega}{c} = \frac{2\pi}{\lambda}$ is the wave number for 2π units of length, and

$\omega = \frac{2\pi}{\tau}$ is the vibration number for 2π units of time. The solution has

six constants of integration $a, \alpha, b, \beta, c, \gamma$; but since one of the three phase-constants α, β, γ may be altered by choosing the point of time $t = 0$, only five of them have a real physical meaning. If we add to this the time of vibration τ and the whole time T of the process of emission, as measures of the frequency and the coherence of the wave, we have, in all, *seven determining elements* for a spherical wave, as given in the text.

The constant vector \mathbf{p} is accounted for by three amplitudes and two phase constants, but for later purposes it is convenient to reduce it to two amplitude-constants, two direction-constants, and one phase-constant. In connexion with this we remark that we can determine three real relative magnitudes $A : B : C$ so that

$$Aae^{i\alpha} + Bbe^{i\beta} + Cce^{i\gamma} = 0,$$

Actually, if we form the real and the imaginary part of the preceding equation, we obtain two homogeneous linear equations by which the three ratio numbers $A : B : C$ are determined. Since, simultaneously,

$$AP_x + BP_y + CP_z = 0$$

holds for every t , the vector \mathbf{P} , which varies with respect to the time, lies continuously in the plane, whose normal is given by the ratios $A : B : C$. We may also speak of it as a "vibration plane"; in it \mathbf{P} describes a "vibration ellipse." By placing the x -axis and the y -axis in this plane, and the z -axis perpendicular to it, the supplementary conditions in eqn. (5) become

$$p_z = 0, \quad p_x = a, \quad p_y = b e^{i\gamma} \dots \dots \dots (5a)$$

where we now denote the phase differences between the y - and the x -axis by $\gamma = \beta - \alpha$ (the earlier phase γ for the z -axis now becomes meaningless). Our integration constants are now separated into the following five quantities: two amplitudes a, b , one phase γ , and the ratios $A : B : C$, which define the position of the plane of vibration.

In the following calculation of the field we have to make frequent use of well-known formulæ of vector analysis. We shall note these here without working them out in detail. The calculation of the moment of momentum is due to Abraham.* But our point of view, based on the quantum theory, requires a different method of representation.

From equation (5) it first follows that

$$\begin{aligned} \operatorname{div} \mathbf{H} &= (\mathbf{Pr}) \frac{1}{r} \frac{\partial}{\partial r} \left(\frac{e^{ikr}}{r} \right), \\ \operatorname{curl} \mathbf{H} &= - \left[\mathbf{P}, \operatorname{grad} \frac{e^{ikr}}{r} \right] = - (\mathbf{Pr}) \frac{1}{r} \frac{\partial}{\partial r} \left(\frac{e^{ikr}}{r} \right), \\ \operatorname{grad} \operatorname{div} \mathbf{H} &= \mathbf{P} \cdot \frac{1}{r} \frac{\partial}{\partial r} \left(\frac{e^{ikr}}{r} \right) + (\mathbf{Pr}) \frac{\mathbf{r}}{r} \frac{\partial}{\partial r} \left[\frac{1}{r} \frac{\partial}{\partial r} \left(\frac{e^{ikr}}{r} \right) \right]. \end{aligned}$$

The first equation (1) then gives us, if we take into account (3) and (4):

$$\begin{aligned} \mathbf{E} &= \mathbf{P} \left(k^2 + \frac{1}{r} \frac{\partial}{\partial r} \right) \frac{e^{ikr}}{r} + (\mathbf{Pr}) \frac{\mathbf{r}}{r} \frac{\partial}{\partial r} \frac{1}{r} \frac{\partial}{\partial r} \frac{e^{ikr}}{r} \\ (\mathbf{rE}) &= (\mathbf{rP}) \left(k^2 + \frac{1}{r} \frac{\partial}{\partial r} + r \frac{\partial}{\partial r} \frac{1}{r} \frac{\partial}{\partial r} \right) \frac{e^{ikr}}{r} \\ &= (\mathbf{rP}) \left(k^2 + \frac{1}{r} \frac{\partial}{\partial r} - \frac{1}{r} \frac{\partial}{\partial r} + \frac{\partial^2}{\partial r^2} \right) \frac{e^{ikr}}{r} \\ &= (\mathbf{rP}) \left(k^2 - k^2 - \frac{2ik}{r} + \frac{2}{r^2} \right) \frac{e^{ikr}}{r} \end{aligned} \quad (6)$$

or, as a first approximation for great values of r ,

$$(\mathbf{rE}) = - 2ik(\mathbf{rP}) \frac{e^{ikr}}{r^2} \dots \dots \dots (7)$$

* *Der Drehimpuls des Lichtes.* Physik. Zeitschr., 15, 914 (1914).

From eqn. (6) it also follows to a first approximation that

$$\mathbf{E} = k^2 \left\{ \mathbf{P} - \frac{\mathbf{r}}{r^2} (\mathbf{Pr}) \right\} \frac{e^{ikr}}{r} \quad (6a)$$

The second eqn. of (1) gives

$$\mathbf{H} = -\frac{1}{c} [\dot{\mathbf{P}}\mathbf{r}] \frac{1}{r} \frac{\partial}{\partial r} \frac{e^{ikr}}{r} = ik [\mathbf{Pr}] \frac{1}{r} \frac{\partial}{\partial r} \frac{e^{ikr}}{r} \quad (8)$$

$$(\mathbf{rH}) = ik(\mathbf{r}[\mathbf{Pr}]) \frac{1}{r} \frac{\partial}{\partial r} \frac{e^{ikr}}{r} = 0. \quad (9)$$

Since $(\mathbf{r}[\mathbf{Pr}]) = (\mathbf{P}[\mathbf{rr}]) = 0$. Finally from (8) it follows as a first approximation for great values of r that

$$\mathbf{H} = -k^2 [\mathbf{Pr}] \frac{e^{ikr}}{r^2} \quad (8a)$$

The moment of momentum for the unit of volume at a distance r from the middle point is, by eqns. (2) and (3) on page 259 of the text [concerning the factor 4π in the denominator, cf. what is said in the case of eqn. (2) on page 259]:

$$\mathbf{M} = \frac{[\mathbf{rS}]}{c^2} = \frac{1}{4\pi c} [\mathbf{rEH}] = \frac{1}{4\pi c} (\mathbf{E}(\mathbf{rH}) - \mathbf{H}(\mathbf{rE}))$$

Or, taking into account eqn. (9), we have

$$\mathbf{M} = -\frac{1}{4\pi c} \mathbf{H}(\mathbf{rE}) \quad (10)$$

If we multiply \mathbf{M} by the element of volume in polar co-ordinates, namely, $r^2 dr d\Omega$, where $d\Omega$ is the solid angle as seen from the mid-point, and set $dr = c dt$; and integrate over all $d\Omega$'s, we get the moment of momentum contained in the spherical shell of radius r and thickness dr , or, expressed in other words, the moment of momentum transferred through the sphere of radius r in the time $dt = dr/c$. The moment of momentum transferred through this sphere during the whole time T of emission was called \mathbf{N} on page 260. Let \mathbf{N}_1 be the moment of momentum transferred in unit time. \mathbf{N} and \mathbf{N}_1 are determined by the following equations:

$$\left. \begin{aligned} \mathbf{N} &= \int_0^T \mathbf{N}_1 dt \\ \mathbf{N}_1 dt &= \int d\Omega \mathbf{M} r^2 dr = c dt \int d\Omega \mathbf{M} r^2 \\ \mathbf{N}_1 &= c \int d\Omega \mathbf{M} r^2 = - \int \frac{d\Omega}{4\pi} \mathbf{H}(\mathbf{rE}) r^2 \end{aligned} \right\} \quad (11)$$

From eqns. (7) and (8a) we see that (\mathbf{rE}) and \mathbf{H} each vanish in the order r^{-1} , since the ratio \mathbf{r}/r denotes a unit vector that is independent of the magnitude of r . Consequently, \mathbf{M} vanishes in the order r^{-2} , as remarked on page 260, and \mathbf{N} and \mathbf{N}_1 become independent of r and are finite.

Before proceeding to the integration in (11) we must pass from our complex representation to its real part. We set, say,

$$\mathbf{O} = \mathbf{Re}\{\mathbf{P}e^{ikr}\}, \quad \mathbf{O}' = \mathbf{Re}\{-i\mathbf{P}e^{ikr}\}. \quad (12)$$

According to the general hypothesis (5) $\mathbf{O}_x, \mathbf{O}_y, \mathbf{O}_z$ we have the meaning [we return later to the more special assumption (5a)]:

$$\left. \begin{aligned} \mathbf{O}_x &= a \cos(kr - \omega t + \alpha), & \mathbf{O}'_x &= a \sin(kr - \omega t + \alpha) \\ \mathbf{O}_y &= b \cos(kr - \omega t + \beta), & \mathbf{O}'_y &= b \sin(kr - \omega t + \beta) \\ \mathbf{O}_z &= c \cos(kr - \omega t + \gamma), & \mathbf{O}'_z &= c \sin(kr - \omega t + \gamma) \end{aligned} \right\} \quad (12a)$$

By (11), (7), and (8a), we then have

$$\begin{aligned} \mathbf{N}_1 &= 2k^3 \int \frac{d\Omega}{4\pi} \left(\frac{\mathbf{r}}{r}, \mathbf{O}' \right) \left| \mathbf{O}, \frac{\mathbf{r}}{r} \right|, \\ \mathbf{N}_{1,x} &= 2k^3 \int \frac{d\Omega}{4\pi} \left(\frac{x}{r} \mathbf{O}'_x + \frac{y}{r} \mathbf{O}'_y + \frac{z}{r} \mathbf{O}'_z \right) \left(\mathbf{O}_y \frac{z}{r} - \mathbf{O}_z \frac{y}{r} \right). \end{aligned}$$

Now, the following values hold:

$$\left. \begin{aligned} \int \frac{d\Omega}{4\pi} \frac{x^2}{r^2} &= \int \frac{d\Omega}{4\pi} \frac{y^2}{r^2} = \int \frac{d\Omega}{4\pi} \frac{z^2}{r^2} = \frac{1}{3} \\ \int \frac{d\Omega}{4\pi} \frac{xy}{r^2} &= \int \frac{d\Omega}{4\pi} \frac{yz}{r^2} = \int \frac{d\Omega}{4\pi} \frac{zx}{r^2} = 0. \end{aligned} \right\} \quad (13)$$

Consequently, if we carry out the integration in $\mathbf{N}_{1,x}$, we get

$$\mathbf{N}_{1,x} = \frac{2}{3}k^3(\mathbf{O}_y\mathbf{O}'_z - \mathbf{O}_z\mathbf{O}'_y) = \frac{2}{3}k^3[\mathbf{OO}']_x. \quad (14)$$

But by eqns. (12a)

$$\left. \begin{aligned} [\mathbf{OO}']_x &= bc \sin(\gamma - \beta) \\ [\mathbf{OO}']_y &= ca \sin(\alpha - \gamma) \\ [\mathbf{OO}']_z &= ab \sin(\beta - \alpha) \end{aligned} \right\} \quad (15)$$

Hence the moment of momentum radiated out through the spherical surface of radius r has by (11), (14), and (15) the components:

$$\left. \begin{aligned} \mathbf{N}_x &= \frac{2}{3}k^3Tbc \sin(\gamma - \beta) \\ \mathbf{N}_y &= \frac{2}{3}k^3Tca \sin(\alpha - \gamma) \\ \mathbf{N}_z &= \frac{2}{3}k^3Tab \sin(\beta - \alpha) \end{aligned} \right\} \quad (16)$$

For the sake of comparison we also calculate the total energy radiated out. In the unit of time the following amount of energy is radiated out through the angular element $d\Omega$:

$$\mathbf{S}_r r^2 d\Omega$$

where \mathbf{S}_r denotes the radial component of the radiation vector \mathbf{S} ; hence the amount radiated through the whole spherical surface in the unit of time is

$$W_1 = \int \mathbf{S}_r r^2 d\Omega \quad (17)$$

and during the time T it is

$$W = \int_0^T W_1 dt. \quad (18)$$

Now if we also pass over to the real vector Ω , then by (6a) and 8a

$$\begin{aligned} [\mathbf{EH}] &= \dots \frac{k^4}{r^2} \left\{ \left| \mathbf{O} \left[\frac{\mathbf{r}}{r} \right] \right|^2 - \left(\frac{\mathbf{O} \cdot \mathbf{r}}{r} \right)^2 \right\} \\ &= \dots \frac{k^4}{r^2} \frac{\mathbf{r}}{r} \left\{ \left(\frac{\mathbf{O} \cdot \mathbf{r}}{r} \right)^2 - \mathbf{O}^2 \right\}, \end{aligned}$$

therefore

$$\begin{aligned} \mathbf{S} &= \frac{c}{4\pi} [\mathbf{EH}] = \frac{k^4 c \mathbf{r}}{4\pi r^2} \left\{ \left(\frac{\mathbf{O} \cdot \mathbf{r}}{r} \right)^2 - \mathbf{O}^2 \right\} \\ \mathbf{S}_r &= \left(\mathbf{S} \cdot \frac{\mathbf{r}}{r} \right) = \dots \frac{k^4 c}{4\pi r^2} \left\{ \left(\frac{\mathbf{O} \cdot \mathbf{r}}{r} \right)^2 - \mathbf{O}^2 \right\} \end{aligned}$$

or also on account of $k = \frac{\omega}{c}$

$$\mathbf{S}_r = \dots \frac{k^3 \omega}{4\pi r^2} \left\{ \left(\frac{\mathbf{O} \cdot \mathbf{r}}{r} \right)^2 - \mathbf{O}^2 \right\}.$$

From eqn. (17) it follows directly

$$W_1 = \int \mathbf{S}_r r^2 d\Omega = \dots k^3 \omega \int \frac{d\Omega}{4\pi} \left\{ \left(\frac{\mathbf{r} \cdot \mathbf{O}}{r} \right)^2 - \mathbf{O}^2 \right\}.$$

If we carry out the integration with respect to $d\Omega$, then, on account of (13), we get

$$W_1 = \frac{2}{3} k^3 \omega \mathbf{O}^2 = \frac{2}{3} k^3 \omega (\mathbf{O}_x^2 + \mathbf{O}_y^2 + \mathbf{O}_z^2). \quad (19)$$

But, owing to (12a), the integration with respect to t denoted in (18) leads to

$$\int_0^T \mathbf{O}_x^2 dt = \frac{T}{2} a^2, \quad \int_0^T \mathbf{O}_y^2 dt = \frac{T}{2} b^2, \quad \int_0^T \mathbf{O}_z^2 dt = \frac{T}{2} c^2.$$

Accordingly, by (18) and (19), the total energy radiated out is

$$W = \frac{1}{3} k^3 \omega T (a^2 + b^2 + c^2). \quad (20)$$

By eliminating T it follows from (16) and (20) that

$$\mathbf{N} = \left\{ \begin{aligned} \mathbf{N}_x &= \frac{W}{\omega} \frac{2bc \sin(\gamma - \beta)}{a^2 + b^2 + c^2} \\ \mathbf{N}_y &= \frac{W}{\omega} \frac{2ca \sin(a - \gamma)}{a^2 + b^2 + c^2} \\ \mathbf{N}_z &= \frac{W}{\omega} \frac{2ab \sin(\beta - a)}{a^2 + b^2 + c^2} \end{aligned} \right\} \quad (21)$$

This is the complete representation of the moment of momentum in arbitrary rectangular co-ordinates x, y, z . If, as in eqn. (5a), we choose the x - and y -axis specially to lie in the plane of vibration, and thus the z -axis perpendicular to it, then we get $c = 0$; and if we write $\beta - a$ for γ , then :

$$\mathbf{N}_x = \mathbf{N}_y = 0, \mathbf{N} = \mathbf{N}_z = \frac{W}{\omega} \frac{2ab \sin \gamma}{a^2 + b^2} \quad (22)$$

This is eqn. (5) on page 261 of the text, from which our further conclusions concerning the principle of selection and polarisation were deduced. We had to resort to the more general representation (21), however, in the case of an external field of force. If in (21) we set $\omega = 2\pi\nu$ and $W = h\nu$, we get, from the third of eqns. (21), again writing $\beta - a$ for γ :

$$\mathbf{N}_z = \frac{h}{2\pi} \frac{2ab \sin \gamma}{a^2 + b^2 + c^2} \quad (23)$$

This is eqn. (1) on page 271 of the text.

10. Bohr's Principle of Correspondence

(To Chapter V, § 3.)

Bohr replaces the investigations which we carried out in Chapter V by his Principle of Correspondence to connect the classical and the quantum view of the phenomena of radiation. By this means he arrives not only at a determination of the polarisations, but also at a determination of the intensities. In view of this achievement, the question as to whether Bohr's procedure is just as satisfactory logically as our less complete method, becomes only of secondary importance: and this question would, moreover, receive a different answer according to the subjective standpoint or perspective adopted. We first show that the correspondence between classical and quantum radiation has its analytical counterpart in the relation between differential quotient (coefficient) and the quotient of differences.

(a) We consider the orbit of a conditionally periodic system with its f vibration numbers ν_k [*vide* eqn. (35) on page 566], or the corresponding periods of vibration $\tau_k = 1/\nu_k$. Here τ_k denotes the mean value of the time in which the co-ordinate q_k vibrates to and fro between its libration limits. By eqn. (35).

$$\nu_k = \frac{dw_k}{dt}$$

and by (34)

$$\frac{dw_k}{dt} = \frac{\partial H}{\partial J_k} = \frac{\partial W}{\partial J_k},$$

thus

$$\nu_k = \frac{\partial W}{\partial J_k} \quad (1)$$

Here W denotes the energy of the conditionally periodic system represented as a function of the phase-integrals J_1, J_2, \dots, J_f .

According to the classical view, the system composed of moving charges radiates in the periods of the motion. Thus the *mechanical vibration frequencies* ν_k are at the same time *optical vibration frequencies*. Besides the ν_k 's themselves, their multiples ("overtones") and the linear compounds of the multiples (combination "tones") occur as mechanical and optical vibration frequencies:

$$\nu = s_k \nu_k \quad \text{and} \quad \nu = \sum_1 s_k \nu_k,$$

where s stands for quite arbitrary numbers, the "order numbers" (*Ordnungszahlen*) of the process of vibration in question. On account of (1) we get for the overtones and combination tones:

$$\nu = \frac{\partial W}{\partial J_k} s_k \quad \dots \quad (2a)$$

and

$$\nu = \sum \frac{\partial W}{\partial J_k} s_k \quad \dots \quad (2b)$$

The result is different, however, on the quantum view. The system does not radiate in the stationary orbits; radiation occurs in the transition from one orbit to another. If ΔW is the difference of energy between the initial orbit and the final orbit, then Bohr's hypothesis

$$\nu = \frac{\Delta W}{h} \quad \dots \quad (3)$$

holds. We shall first assume that in the transition only one of the quantum numbers n_k alters by the amount Δn_k . Since $J_k = n_k h$, that is, $\Delta J_k = \Delta n_k \cdot h$, we may write, in place of (3),

$$\nu = \frac{\Delta W}{\Delta J_k} \Delta n_k \quad \dots \quad (4)$$

For $\Delta n_k = 1$ we have the analogon to eqn. (1); for $\Delta n_k = s_k$ the analogon to eqn. (2a). *The quantum leap 1 is the parallel to the fundamental vibration, the higher quantum leaps correspond to the overtone vibrations of classical radiation.* But the combination-vibrations (2b) have also a quantum analogon as soon as we take into consideration quantum transitions in which several quantum numbers leap simultaneously. We dissociate the total change of energy ΔW in the form of a cascade into the partial changes of energy $\Delta W_1, \Delta W_2, \dots, \Delta W_f$, which are to correspond to the successive quantum leaps $\Delta n_1, \Delta n_2, \dots, \Delta n_f$. In the partial change of energy ΔW_1 all the n_2, \dots, n_f have their initial values, and only n_1 changes from its initial value by the amount Δn_1 . In the case of $\Delta W_2, n_1$ has its final value, whilst n_3, \dots, n_f their initial values, and only n_2 alters by Δn_2 , and so forth. Thus if we write in place of (3)

$$\nu = \frac{\Delta W}{h} = \frac{\Delta W_1}{h} + \frac{\Delta W_2}{h} + \dots + \frac{\Delta W_f}{h}$$

or after the model of (4)

$$\nu = \sum \frac{\Delta W}{\Delta J_k} \Delta n_k \quad \dots \quad (5)$$

that the hydrogen electron would radiate according to the classical theory in traversing its orbit coincides with the vibration number that Balmer's formula gives for the cases when the quantum numbers of the initial and final orbit are great, in particular when these quantum numbers differ by unity: when they differ by two or more, Balmer's vibration number becomes an overtone of the circular vibration calculated on the classical theory.

The coincidence of the vibration numbers calculated on the quantum and on the classical theory, respectively, for high quantum numbers and relatively small quantum leaps is perfect from the formal aspect. Nevertheless there remains a considerable difference of view in the matter itself. From the classical point of view all vibrations, overtones and combination tones, are emitted *simultaneously* when the orbit is being traversed. The whole vibration spectrum owes its origin to one uniform event. From quantum point of view, however, each line of the spectrum corresponds to a different single event and a different kind of quantum leap. The individual events do not necessarily occur simultaneously, but rather *independently of each other*. And experiments on the excitation of spectral lines confirm throughout the view-point of the quantum theory, and thus contradict the classical theory.

(c) The correspondence or the coincidence, respectively, of the vibration numbers in the two theories is certainly not merely fortuitous but rather is deeply rooted in the part played by the classical theory of vibration as a "continuum-approximation" for discontinuous reality. Is it to be valid only for vibration numbers and not to extend to the vibration forms and the vibration quantities, that is, to the polarisations and the amplitudes? For the circumstances defined in (b) for great quantum numbers this will scarcely be denied. But, beyond this, Bohr requires that amplitudes, etc., calculated on the classical theory should be useful approximations for moderate and small quantum numbers, too. Just this further extension constitutes the fruitfulness of his principle of correspondence. We formulate this principle in the following words. *To every quantum transition there corresponds a vibration deduced from the classical theory, namely that of which the order numbers s_k are equal to the quantum leaps Δn_k . Now calculate the amplitude and the polarisation of the partial vibration in question by classical methods and apply them to the spectral line corresponding to the related quantum leap. The principle of correspondence asserts that in this way we get the intensity and the polarisation of the spectral lines exactly right for infinitely great, and approximately right for moderate, quantum numbers.*

Now how do we find, on the classical theory, the radiation of a single partial vibration that takes place in the time in which the atomic orbit is traversed? For this we have to take our support on eqn. (1) on page 25, in which the product of the charge and acceleration $e\ddot{\mathbf{v}}$ of the electron there considered occurs. By summing this product, in the use of a composite atom, over all electrons (including the nucleus that may happen to be moving with them), we get a vector

$$\sum \pm e\ddot{\mathbf{v}},$$

which is the decisive feature of the emitted radiation and which we may resolve into its three rectangular components \mathbf{O}_x , \mathbf{O}_y , \mathbf{O}_z . In its stead we

must come out appreciably equal. In the case of values of Δn_k that are comparable with n_k , however, the D's in general become different for the initial and the final orbit and hence a certain arbitrariness remains in applying the principle of correspondence.

This arbitrariness vanishes in particular when it also happens for finite values of n_k that the D's of the initial and the final orbit and, as Bohr emphasises, also of the intermediate orbits have the same value, for example, the value zero. In this case we shall also have no scruples in inferring the value zero of the radiation. The principle of correspondence then becomes specialised and condensed into a *principle of selection*; it forbids the occurrence of such spectral lines the corresponding partial vibrations of which do not occur in the series expansion (8).

We return below, at (f) to the example that is essential to us for manipulating this principle of selection (when a cyclic co-ordinate is present). Let it suffice for the present to illustrate the process by the ordinary Lissajous case. In it, thanks to the special simplicity of the quasi-elastic binding, the infinite Fourier-expansion for each component of \mathbf{P} reduces itself (cf. p. 567, Note 7) to a single frequency

$$\mathbf{P}_x = D_1 e^{2\pi i \nu_1 t}, \quad \mathbf{P}_y = D_2 e^{2\pi i \nu_2 t}, \quad \mathbf{P}_z = D_3 e^{2\pi i \nu_3 t} \quad (9)$$

where we have in each case to suppose the conjugate imaginary member of equal frequency to be added. Comparing this with the general representation (8) we see that for \mathbf{P}_x in each case $s_2 = s_3 = 0$, whereas of all the values s_1 between $-\infty$ and $+\infty$ only the one value $|s_1| = 1$ presents itself actually; corresponding results hold for \mathbf{P}_y , \mathbf{P}_z . From this we conclude in accordance with the principle of correspondence that none of the three quantum leaps Δn_1 , Δn_2 , Δn_3 can combine with either of the others. If n_1 jumps, n_2 and n_3 remain unchanged, and *vice versa*; moreover n_1 (and likewise n_2 , n_3) can jump only by 1. The light emitted when n_1 jumps is linearly polarised in the direction of x , that when n_2 jumps is polarised in the y -direction, and so forth. (We hereby of course assume that we are not dealing with degenerate cases, that is, we suppose ν_1, ν_2, ν_3 to be all different.) Accordingly, the whole spectrum of the quasi-elastically and anisotropically bound oscillator consists only of three separate lines with linear x -, y -, z -polarisation. In this case we have moreover the peculiarity that the quantum-determined ν 's come out identical with those given by the classical theory, namely ν_1, ν_2, ν_3 (on account of the quantising of the energy of the oscillator $W = \sum n_i \cdot h\nu_i$); that is, in this case the correspondence resolves into coincidence not only for great vibration numbers but also for small frequencies. In this case, moreover, there is nothing arbitrary in the application of the principle of correspondence, since in all these co-ordinates we have the same form of representation for the initial, final, and intermediate orbits.

As the extreme special case Planck's linear harmonic oscillator, of course, also belongs to the category of Lissajous motions. If there were a vibrating system of this simple type in nature, its spectrum would have to consist of a single line having the vibration frequency of classical emission and would have to be produced merely by quantum leaps of ± 1 . In the case of a linear but non-harmonic oscillator (for example, with a supplementary quadratic term in the expression for the restoring force) the overtones will also occur, and, indeed, with definite amplitudes

which bear ratios to the fundamental vibration that have to be calculated in accordance with the principle of correspondence. If the fundamental vibration of the oscillation is ν_0 and the direction of vibration is along the x -axis, the formula is :

$$P_x = \sum_{-\infty}^{+\infty} D_s e^{2\pi i s \nu_0 t} (9a)$$

Hence, according to the principle of correspondence, in the case of the non-harmonic oscillator we have, besides the quantum leap ± 1 , also any arbitrary leaps $\Delta n = \pm s$. We made use of this in Chapter VII, §§ 2 and 4, in dealing with band-spectra.

With regard to atomic models it is to be noted that in the case of the principle of correspondence we are dealing with the emission of electric charges and that \mathbf{P} was intentionally defined in (7) as the moment, varying in time, of such charges. In the application to band-spectra we thus have in mind an oscillator with a variable electric moment. A heteropolar dipole like H^+Cl^- , or complicated configurations like $\text{H}^+\text{H}^+\text{O}^-$, correspond to such an oscillator; but homoeopolar molecules like O_2 , N_2 , H_2 , Cl_2 , do not correspond to it. The latter when their constituents, bearing equal charges, vibrate with respect to one another, lead to no electric moment and hence, on the classical view, to no emission of radiation; thus, on the quantum theory, too, they may not radiate. It is in agreement with this that it has not been possible in their case to prove the occurrence of infra-red absorption (cf. p. 418).

The case of a homoeopolar molecule is different if one of its constituents is electrically excited by disturbing the electronic orbits. By this means the molecule may acquire an electric moment as a whole and may become capable of emitting radiation as an oscillator. We infer, for example, in the typical case of the N_2 -bands (cf. Chap. VII, § 3), that in them the oscillations (and likewise the rotations) of the homoeopolar N_2 -molecule can become active spectrally, *but only in conjunction with electronic motions*, that lead to an electric moment, or, in quantum language, *in conjunction with electronic leaps*.

Further applications of the principle of correspondence to the calculation of amplitudes in the case of systems of the hydrogen-type are given by H. A. Kramers in his dissertation, quoted on page 275. Here we are already confronted with the case that we must use a certain dexterity in balancing between the values of the D 's in the initial and the final orbit. The excellent agreement with experiment, which Kramers reaches particularly in the case of Paschen's He^+ -observations, as well as in that of the Stark-effect, shows that a balance is possible, and thus contributes convincing evidence of the fruitfulness of Bohr's principle of correspondence.

(e) We stated on page 275 that Bohr had discovered in his principle of correspondence "a magic wand that allowed the results of the classical wave theory to be of use for the quantum theory." To bring into prominence the astonishing effectiveness of this magic wand we have to remember that the question of intensity is in reality a *statistical problem*. The quantum theory considers individual events in the atom, all involving the same quantity of energy $h\nu$, so far as we are dealing with a definite spectral line, and it has no measure which tells us how frequently this

event occurs. But it is just this frequency of happening that is of importance to us when we are dealing with the determination of the intensity from the quantum point of view. The classical theory of radiation, too, makes no hypotheses of probability, it just derives mechanically from a given orbital curve the vibration complex contained in it together with its amplitudes. But the principle of correspondence asserts that *the unknown statistics of the individual quantum events are actually furnished by the classical calculation. By calculating the Fourier coefficients of the spectrum we get the correct conditions of intensity, that is, the numbers giving the relative frequency of happening of the corresponding quantum events.* Although we are convinced that the quantum theory is right in regarding the events that lead to the emission of different spectral lines as independent phenomena, and although we know that the classical calculation is incorrect in treating these events as conditioned mechanically by the motion in the orbit, we yet repose trust in the classical theory to the extent that we derive from it the conditions of intensity of the spectral lines. The classical theory is in error in regarding these conditions of intensity as determined by mechanics; in reality, it furnishes the quantum theory with the missing statistics of the individual processes, as it were, without wanting to do so and without giving grounds for it in its foundation. This interlocking of the quantum theory and the classical theory becomes intelligible to some extent of course only from the side of great quantum numbers. The classical theory here hits on the correct vibration numbers. We believe therefore that for great quantum numbers, too, it will yield the correct conditions of intensity, actually then, the true statistics of the individual phenomenon. Consequently we can understand that we may enlist the aid of the classical theory to get at least approximate results for the statistics in the case of finite or small quantum numbers, too.

(f) We now get to the most important application of the principle of correspondence, namely to the case in which one of the variables of separation is cyclic. We call this cyclic co-ordinate ϕ , and the remaining variables q_2, q_3, \dots, q_f . From the definition of cyclic variables (the expression for the energy is independent of ϕ ; the corresponding momentum, $p = \frac{\partial S}{\partial \phi}$, is constant) it follows that S is represented by:

$$S = \frac{1}{2\pi} J_\phi \cdot \phi + s(q_2, \dots, q_f, J) \quad . \quad . \quad . \quad (10)$$

where $J_\phi (= 2\pi p)$ and s are independent of ϕ , and hence depend only on $q_2 \dots q_f$ and the phase-integrals J (in general including J_ϕ). In accordance with the definition of angular co-ordinates in Note 7, eqn. (32), we get $k = 2, 3, \dots, f$, by differentiating (10) with respect to J_k

$$w_k = f_k(q_2, \dots, q_f, J),$$

where we have set $f_k = \frac{\partial s}{\partial J_k}$, or, resolving these equations, we get inversely

$$q_k = F_k(w_2, \dots, w_f, J) \quad . \quad . \quad . \quad (11)$$

In particular, we get for $k = 1$, now differentiating (10) with respect to J_ϕ :

$$w_\phi = \frac{\phi}{2\pi} + \psi(q_2, \dots, q_i, J)$$

where we have set $\psi = \frac{\partial s}{\partial J_\phi}$. Taking into account (11) we may also write

$$\phi = 2\pi w_\phi + \Psi(w_2, \dots, w_f, J) \quad (11a)$$

The case of a cyclic variable ϕ certainly occurs in an atom which is under no forces. Here we find it expedient to refer the co-ordinates of its point-masses to the invariable plane drawn through its centre of gravity and denote them by r_k, z_k, ϕ_k (z_k = the distance of the k^{th} point-mass from the invariable plane, ϕ_k = its azimuth in this plane, and so forth). Then we may pick on one of the ϕ_k 's (for example, $\phi_1 = \phi$) as a cyclic co-ordinate and express the relative azimuths $\phi_k - \phi$, which are alone of account as far as inner forces are concerned, as well as the r_k 's and z_k 's, by means of the remaining variables of separation q . If we consider the combination $x_k + iy_k$ for each of the point-masses, we find that

$$x_k + iy_k = e^{i\phi} \cdot r_k e^{i(\phi_k - \phi)} = e^{i\phi} f(q_2, \dots, q_i)$$

and hence that

$$\mathbf{P}_x + i\mathbf{P}_y = \sum \pm e(x_k + iy_k) = e^{i\phi} f_1(q_2, \dots, q_i).$$

$$\mathbf{P}_z = \sum + ez = f_2(q_2, \dots, q_i).$$

If we now insert (11) and (11a), set $w_\phi = vt + \delta$, $w_k = v_{kt} + \delta_k$, and write f_1, f_2 by eqn. (8) in Fourier series, we get

$$\mathbf{P}_x + i\mathbf{P}_y = e^{2\pi i vt} \left(\sum \right)^{f-1} D_{s_2, \dots, s_f} e^{2\pi i (s_2 v_2 t + \dots + s_f v_f t)} \quad (12)$$

$$\mathbf{P}_z = \left(\sum \right)^{f-1} E_{s_2, \dots, s_f} e^{2\pi i (s_2 v_2 t + \dots + s_f v_f t)} \quad (13)$$

Here it is, above all, to be noted that the summation letter s corresponding to the cyclic azimuth occurs in (12) only with the value $s = 1$ [as well as with $s = -1$, if we form the real part of (12) and hence add the conjugate imaginary part], whereas in (13) it occurs only with the value $s = 0$. From this it follows by the principle of correspondence that the azimuthal quantum leap Δn is only capable of assuming the values ± 1 and 0. To the quantum leap ± 1 there correspond circularly polarised vibrations parallel to the invariable plane; to the quantum leap 0 there corresponds a linearly polarised vibration perpendicular to the invariable plane. These are our results of Chapter V, § 2, page 266, where now the direction of the linear polarisation, which earlier made an auxiliary argument necessary, also comes out without difficulty.

If we are dealing with only one electron (Kepler orbit, hydrogen atom) the invariable plane becomes the orbital plane; $z = 0$, $\mathbf{P}_z = 0$ then hold, and thus all the coefficients E in (13) vanish. This signifies, according to the principle of correspondence, that all the lines come out with $\Delta n = 0$ (that is, they are polarised perpendicularly to z). We thus arrive at the special Bohr principle of selection which we made intelligible in Chapter V, page 269, by means of an auxiliary argument.

(g) We here give only a few test examples of the rich field of application of the principle of correspondence and refer for other examples to the recent works of Bohr and Kramers (*loc. cit.*). In particular the investigation to be made by Bohr, mentioned on page 59, promises undreamed-of fruits from the principle of correspondence.

We next speak of series spectra produced in the absence of fields. Have we here to expect the transition $\Delta n = 0$ or not? In the case of the hydrogen atom the answer is clear. Its orbits are plane, hence (on account of $P_z = 0$) $\Delta n = 0$ is to be rejected. In the case of spectra that are not of the hydrogen type the answer becomes less free from ambiguity. If the supplementary field of the atom may be treated, as we actually did treat it, as a *central force* (cf. p. 326), the orbit becomes plane here, too, and hence $\Delta n = 0$ is forbidden. General experimental results about the combination of series terms (cf. Chap. V, § 2) are in good agreement with this. Thus the assumption of plane orbits seems in general to agree with reality. But we must not be surprised if, for example, in the alkaline earths, we encounter term combinations of the form (d, d') or (p, p') (cf. p. 368). In the language of the principle of correspondence they may be explained simply on the ground that we are not here dealing with a central field nor with plane orbits. As a matter of fact eqn. (13) allows the quantum leap $\Delta n = 0$ in the case of non-planar orbits.

The position is quite definite and unambiguous again in the homogeneous electric field, according to the principle of correspondence as well as to our arguments in Chapter V, § 3. The equatorial azimuth ϕ counted round the direction of the lines of force is here the cyclic co-ordinate. With this altered meaning of ϕ , eqns. (12) and (13) stand as before. The principle of selection now concerns only the "equatorial quantum number," whose leaps are restricted to ± 1 and 0. In the case of the individual hydrogen electron, too, z is no longer equal to 0, and hence the linearly polarised vibrations in the z -direction occur with finite intensity.

We pass on to the band-spectra and for this purpose we apply the formulæ of the preceding section (*f*) to the case of a dipole, which we suppose vibrating along its axis and at the same time being turned uniformly about its z -axis which is perpendicular to the former. Let the angular velocity be ω , the fundamental vibration of the dipole being ν_0 as in eqn. (9a). In place of (12) and (13) we get, by multiplying (9a) by $e^{i\omega t}$:

$$P_x + iP_y = e^{i\omega t} \sum_{-\infty}^{+\infty} D_n e^{2\pi i \nu_n t}, \quad P_z = 0 \quad . \quad . \quad . \quad (14)$$

If we assign to the oscillations the quantum numbers n , and to the rotations the quantum numbers m , then we read from eqn. (14) that the quantum leaps $\Delta n = \pm s$ are arbitrary and are always connected with the quantum leaps $\Delta m = \pm 1$. [The negative sign contained in eqn. (14) in so far as the summation extends from $-\infty$ to $+\infty$ and $+i$ may be exchanged with $-i$]. *This contains the principle of selection, eqn. (3) on page 418, for rotation and oscillation quanta of band-spectra.*

We here assumed a pure rotation of the molecule about the z -axis. If, instead of this, we consider as in Chapter VII, § 6, a *precessional motion*, whereby we place the z -axis along the axis of the total moment

of momentum of this precessional motion, the projection of the electric moment \mathbf{P} on to the z -axis or, respectively, the xy -plane becomes equal to $|\mathbf{P}| \cos \theta$ or $|\mathbf{P}| \sin \theta$, respectively [θ denotes (cf. p. 443) the Eulerian angle between the axis of the precession and the "axis of figure" of the "gyroscope" which we have assumed symmetrical or approximately symmetrical]. If ω now denotes the precessional velocity of the gyroscope then we get in place of (14)

$$\mathbf{P}_x + i\mathbf{P}_y = e^{i\omega t} |\mathbf{P}| \sin \theta, \quad \mathbf{P}_z = |\mathbf{P}| \cos \theta. \quad (15)$$

where we suppose the Σ of (14) inserted in place of $|\mathbf{P}|$.

The quantum number m of the total momentum is now allocated to the precessional velocity ω just as formerly the quantum number m of the rotation corresponded to the rotational velocity ω . From eqn. (15) for $\mathbf{P}_x + i\mathbf{P}_y$ we now deduce, as previously from (14), the quantum leap $m \pm 1 \rightarrow m$ and infer that it is connected with the quantum leaps of the oscillation quantum n . From eqn. (15) for \mathbf{P}_z it, however, now follows that *the oscillation quantum may also jump alone, that is that an emission is possible during which m does not change.* This is what we required on page 446 to explain the zero branch of the band-spectra. It cannot, of course, be established by actual observation that this emitted radiation is polarised along the z -axis as demanded by the principle of correspondence, since the z -axis is not defined in space.

All of the preceding remarks apply to molecules whose ions form an electric dipole (HCl, etc.). For homoeopolar molecules (N_2 , etc.) we must, as on page 583, go back to the electronic motions that occur in them, or, in the language of quanta, to the corresponding quantum leaps.

Finally, we also wish to consider the case of a rotationless molecule. The factor $e^{i\omega t}$ in eqn. (14) or eqn. (15) then drops out, and, by the principle of correspondence, any arbitrary jumps of the oscillation quantum that are not accompanied by jumps of the rotation quantum would be possible. For band-spectra this would signify that the frequency of vibration ν_0 of the nucleus and its overtone vibrations could occur as singular lines of the band, for example, the dotted line ν_0 in the sketch of Fig. 103 on page 421. In reality, such singular lines are never observed. From this we must conclude that the rotationless state never occurs so as to be of account in practice. As already emphasised on page 422, this conclusion is not to be derived from the principle of correspondence alone but only in conjunction with observation.

Recapitulating, we establish that the principle of correspondence furnishes with great certainty and ease not only the same results as we found earlier by considerations of the moment of momentum, but refines these results considerably, particularly as regards the calculation of amplitudes.

11. The Stark Effect treated according to the Hamilton-Jacobi Method

(To Chapter V, §§ 4 and 5)

In the case of the Stark effect, too, we reach our goal most quickly and with most certainty by using the method of the separation of variables. In particular, this method shows why we have to express the

quantum conditions in parabolic co-ordinates (ξ, η, ψ) . Following on from Fig. 77, page 279 we next define *parabolic co-ordinates* ξ, η in the plane. Let x and y be rectangular co-ordinates, the x -axis being in direction of the field, O being the nucleus. The relationship between them and the parabolic co-ordinates ξ, η allows itself to be written most conveniently in the imaginary form

$$x + iy = \frac{1}{2}(\xi + i\eta)^2 \quad . \quad . \quad . \quad (1)$$

By identifying the real and the imaginary parts we get

$$x = \frac{1}{2}(\xi^2 - \eta^2), \quad y = \xi\eta \quad . \quad . \quad . \quad (2)$$

If we eliminate ξ or η from these two equations we get in agreement with eqn. (1) on page 279 :

$$\frac{y^2}{\eta^2} - 2x = \eta^2 \quad \text{or} \quad \frac{y^2}{\xi^2} + 2x = \xi^2 \quad . \quad . \quad . \quad (3)$$

respectively.

The first (or second) of eqns. (3) shows that if we set η (or ξ) equal to a constant, we get a parabola which has for its axis the positive (or negative) direction of the x -axis. Its focus lies at O, its vertex has the co-ordinates $x = -\eta^2/2$ (or $x = +\xi^2/2$). If we give η (or ξ) all possible fixed values, we get the one (or the other) system of parabolas of Fig. 77.

From (1) we form the line-element in the plane, that is the distance between two neighbouring points PP' , and, again, this is most simply done by using imaginary quantities. By differentiating (1) we get

$$dx + idy = (\xi + i\eta)(d\xi + id\eta)$$

and by passing on to the absolute value we have

$$ds^2 = dx^2 + dy^2 = (\xi^2 + \eta^2)(d\xi^2 + d\eta^2) \quad . \quad . \quad (4)$$

If, on the other hand, we proceed to take the absolute value in eqn. (1) we get the finite distance r of any point P of the plane from the origin O :

$$r^2 = x^2 + y^2 = \frac{1}{4}(\xi^2 + \eta^2)^2 \quad . \quad . \quad . \quad (5)$$

We next imagine the diagrammatic plane of Fig. 77 turned about the x -axis and call the angle through which it is turned ψ . The above y -co-ordinate then denotes the distance ρ from the axis of rotation. The three-dimensional rectangular co-ordinates x, y, z now to be introduced are then expressed as follows in terms of our above plane co-ordinates x and y (where, however, we write ρ for y in the sequel) and the angle ψ :

$$x = x, \quad y = \rho \cos \psi, \quad z = \rho \sin \psi.$$

The *line-element in space* becomes

$$ds^2 = dx^2 + dy^2 + dz^2 = dx^2 + d\rho^2 + \rho^2 d\psi^2 \quad . \quad . \quad (6)$$

and the *finite distance in space* of any point from O becomes

$$r^2 = x^2 + y^2 + z^2 = x^2 + \rho^2 \quad . \quad . \quad . \quad (7)$$

11. Stark Effect according to the Hamilton-Jacobi Method 589

Since ρ is identical with y as used above, the value of (7) arises directly out of (2) :

$$r^2 = \frac{1}{4}(\xi^2 - \eta^2)^2 + \xi^2\eta^2 = \frac{1}{4}(\xi^2 + \eta^2)^2, \quad r = \frac{1}{2}(\xi^2 + \eta^2) \quad (8)$$

It is to be regarded as an essential advantage of the parabolic co-ordinates over the rectangular co-ordinates that r allows itself to be expressed rationally without a root sign in this way by means of ξ and η .

In the same way the value of $dx^2 + dy^2$ in (6) arises out of (4). If, further, we replace ρ in (6) by the value of y in (2), (6) becomes

$$ds^2 = (\xi^2 + \eta^2)(d\xi^2 + d\eta^2) + \xi^2\eta^2 d\psi^2 \quad (9)$$

From (9) we now extract the expression for the kinetic energy in parabolic co-ordinates (m = mass of the electron) :

$$E_{kin} = \frac{m}{2} \left(\frac{ds}{dt} \right)^2 = \frac{m}{2} \left\{ (\xi^2 + \eta^2)(\dot{\xi}^2 + \dot{\eta}^2) + \xi^2\eta^2\dot{\psi}^2 \right\} \quad (10)$$

The potential energy is

$$E_{pot} = -\frac{eE}{r} + eFy$$

(where E = nuclear charge, F = field strength, $-eE/r$ = strength of field action on electron). On account of (8) and (2) this becomes in parabolic co-ordinates :

$$\left. \begin{aligned} E_{pot} &= -\frac{2eE}{\xi^2 + \eta^2} + \frac{eF}{2}(\xi^2 - \eta^2) \\ &= \frac{1}{2(\xi^2 + \eta^2)} \left\{ -4eE + eF(\xi^4 - \eta^4) \right\} \end{aligned} \right\} \quad (11)$$

From (10) the momenta p_ξ, p_η, p_ψ follow by differentiation with respect to the parabolic co-ordinates of the velocity, $\dot{\xi}, \dot{\eta}, \dot{\psi}$ in conformity with eqn. (5) on page :

$$p_\xi = m(\xi^2 + \eta^2)\dot{\xi}, \quad p_\eta = m(\xi^2 + \eta^2)\dot{\eta}, \quad p_\psi = m\xi^2\eta^2\dot{\psi} \quad (12)$$

Hence, expressed as a function of the momenta, (10) allows itself to be written as follows :

$$E_{kin} = \frac{1}{2m(\xi^2 + \eta^2)} \left\{ p_\xi^2 + p_\eta^2 + \left(\frac{1}{\xi^2} + \frac{1}{\eta^2} \right) p_\psi^2 \right\} \quad (13)$$

The sum of (11) and (13) is the expression of the total energy in parabolic position- and momentum-co-ordinates, or, according to page 194, it is the *Hamiltonian function* H . It is invariable during the motion and equal to the energy constant W . Hence we have

$$\left. \begin{aligned} 2m(\xi^2 + \eta^2)W &= p_\xi^2 + p_\eta^2 + \left(\frac{1}{\xi^2} + \frac{1}{\eta^2} \right) p_\psi^2 \\ &\quad - 4meE + meF(\xi^4 - \eta^4) \end{aligned} \right\} \quad (14)$$

in agreement with eqn. (2) on page 280. If we here set

$$p_\xi = \frac{\partial S}{\partial \xi}, \quad p_\eta = \frac{\partial S}{\partial \eta}, \quad p_\psi = \frac{\partial S}{\partial \psi}$$

we get the partial differential equation for the function of action S in the following form :

$$\left. \begin{aligned} & \left(\frac{\partial S}{\partial \xi} \right)^2 + \left(\frac{\partial S}{\partial \eta} \right)^2 + \left(\frac{1}{\xi^2} + \frac{1}{\eta^2} \right) \left(\frac{\partial S}{\partial \psi} \right)^2 \Big\} \\ & = 2m(\xi^2 + \eta^2)W + 4meE - meF(\xi^4 - \eta^4) \end{aligned} \right\} \quad (15)$$

where ψ is the cyclic co-ordinate. Hence

$$\frac{\partial S}{\partial \psi} = p_\psi = \text{const.}$$

holds. And for the equatorial quantum condition we get

$$J_\psi = 2\pi I_\psi = n_3 h \quad (16)$$

Hereupon eqn. (15) passes into

$$\left. \begin{aligned} & \left(\frac{\partial S}{\partial \xi} \right)^2 + \left(\frac{\partial S}{\partial \eta} \right)^2 = 2m(\xi^2 + \eta^2)W + 4meE \Big\} \\ & - meF(\xi^4 - \eta^4) - \left(\frac{1}{\xi^2} + \frac{1}{\eta^2} \right) \left(\frac{n_3 h}{2\pi} \right)^2 \end{aligned} \right\} \quad (17)$$

We write the terms dependent on ξ on the left and those dependent on η on the right and have thereby effected *the separation of the variables*. The separated parts must be equal to the same constant, which we shall conveniently call $2m\beta$:

$$\begin{aligned} & \left(\frac{\partial S}{\partial \xi} \right)^2 - 2m\xi^2 W - 2meE + meF\xi^4 + \frac{1}{\xi^2} \left(\frac{n_3 h}{2\pi} \right)^2 \\ & = - \left(\frac{\partial S}{\partial \eta} \right)^2 + 2m\eta^2 W + 2meE + meF\eta^4 - \frac{1}{\eta^2} \left(\frac{n_3 h}{2\pi} \right)^2 \\ & = 2m\beta. \end{aligned}$$

From this we get by calculation

$$\frac{\partial S}{\partial \xi} = \sqrt{f_1(\xi)}, \quad \frac{\partial S}{\partial \eta} = \sqrt{f_2(\eta)}$$

in which f_1 and f_2 have the meaning given in eqn. (7) on page 281. Hence *the quantum conditions for the parabolic co-ordinates* ξ, η , written as periodic moduli of the function of action are :

$$J_\xi = \oint \sqrt{f_1(\xi)} d\xi = n_1 h, \quad J_\eta = \oint \sqrt{f_2(\eta)} d\eta = n_2 h \quad (18)$$

Both integrals have the same form. By using ξ^2 in the first integral, and η^2 in the second as new integration variables [called r in each case in (19)], we have

$$\oint \sqrt{A + 2\frac{B}{r} + \frac{C}{r^2}} + Dr dr = 2nh \quad (19)$$

On the right-hand side of this equation, n stands for n_1 , the first time, and for n_2 the second time. The factor 2 before n has been transposed

11. Stark Effect according to the Hamilton-Jacobi Method 591

from the left-hand side and is due to the circumstance that $\xi d\xi$ or $\eta d\eta$, respectively, is equal to $dr/2$. The coefficients A, B, C, D first denote

$$\left. \begin{aligned} A_1 &= 2mW, & B_1 &= m(eE + \beta), & C_1 &= -\left(\frac{n_3 h}{2\pi}\right)^2 \\ & & D_1 &= -meF \end{aligned} \right\} \quad (20a)$$

and, on the second occasion

$$\left. \begin{aligned} A_2 &= 2mW, & B_2 &= m(eE - \beta), & C_2 &= -\left(\frac{n_3 h}{2\pi}\right)^2 \\ & & D_2 &= +meF \end{aligned} \right\} \quad (20b)$$

We have already anticipated the calculation of the left side of (19) in Note 6 under (f). By eqn. (26) of (f) it leads to

$$-2\pi i \left\{ \sqrt{C} - \frac{B}{\sqrt{A}} - \frac{D}{4A} \left(\frac{3B^2}{A} - C \right) \right\} \quad (21)$$

Consequently, if we arrange (19) in terms of B, we get the equation :

$$B = \sqrt{A} \left(\sqrt{C} - \frac{nh i}{\pi} \right) + \frac{D}{4A} \left(C - \frac{3B^2}{A} \right) \quad (22)$$

We regard the coefficient of D as a correction member (the external field is assumed small compared with the nuclear field) and in it we therefore replace B^2/A by the following value from (22), which is a first approximation :

$$\frac{B^2}{A} = \left(\sqrt{C} - \frac{nh i}{\pi} \right)^2, \quad C - \frac{3B^2}{A} = -2C + 6 \frac{nh i}{\pi} \sqrt{C} + 3 \left(\frac{nh}{\pi} \right)^2$$

Accordingly (22) becomes

$$B = \sqrt{A} \left(\sqrt{C} - \frac{nh i}{\pi} \right) + \frac{D}{4A} \left(\frac{3n^2 h^2}{\pi^2} + \frac{6nh i}{\pi} \sqrt{C} - 2C \right) \quad (23)$$

This single equation really represents two equations. We suppose them written once for

$$B = B_1 = m(eE + \beta), \quad D = D_1 = -meF, \quad n = n_1,$$

and a second time for

$$B = B_2 = m(eE - \beta), \quad D = D_2 = +meF, \quad n = n_2,$$

where A and C have in each case the values

$$A = 2mW, \quad C = -\left(n_3 h/2\pi\right)^2.$$

We then form half the sum of the equations resulting in this way. This causes the integration constant β , which is of no interest to us at present, to cancel out, and so we get

$$\left. \begin{aligned} meE &= \sqrt{A} \left(\sqrt{C} - \frac{(n_1 + n_2) h i}{2\pi} \right) \\ &+ \frac{meF}{4A} \left(\frac{3}{2} \left(\frac{n_2^2 - n_1^2}{\pi^2} h^2 + 3 \left(\frac{n_2 - n_1}{\pi} \right) h i \sqrt{C} \right) \right) \end{aligned} \right\} \quad (24)$$

We insert in it

$$\sqrt{C} = -\frac{n_3 h i}{2\pi},$$

(concerning the sign, cf. p. 552) and next calculate A to a first approximation, that is, for $F = 0$:

$$A = -\frac{4\pi^2(m_e E)^2}{(n_1 + n_2 + n_3)^2 h^2} \quad (25)$$

We insert this value in the correction member multiplied by F in eqn. (24) and now evaluate A to a second approximation:

$$A = -\frac{4\pi^2(m_e E)^2}{(n_1 + n_2 + n_3)^2 h^2} - \frac{3F h^2}{4\pi^2 E} (n_2 - n_1)(n_1 + n_2 + n_3).$$

Dividing this by $2m$ we arrive at the value given in eqn. (1) on page 286:

$$W = -\frac{2\pi^2 m_e^2 E^2}{(n_1 + n_2 + n_3)^2 h^2} - \frac{3h^2 F}{8\pi^2 m_e E} (n_2 - n_1)(n_1 + n_2 + n_3) \quad (26)$$

As has been discussed more fully in the text, the second term on the right of eqn. (25) contains the entire manifold of phenomena that Stark has observed in the various Balmer lines. "We may perhaps say without exaggeration that the formal explanation of these phenomena cannot be given more simply than has been done in the above sentences."*

Various conclusions may also be read off from the above concerning the shape of the orbital curve. Here the integration constant β that was eliminated above becomes of account. In working it out we restrict ourselves to the case of an arbitrarily weak field (the Kepler motion $F = 0$ considered on p. 311). Thus we set $D = 0$ in the two equations comprised in (23) and form half their difference:

$$m\beta = \sqrt{A} \frac{n_2 - n_1}{2\pi} h i \quad (27)$$

If we insert in this the first approximation (25) of A, it simply follows that

$$\beta = eE \frac{n_2 - n_1}{n_1 + n_2 + n_3} \quad (28)$$

Thus, for $F = 0$, the eqns. (7), $f_1(\xi) = 0$ and $f_2(\eta) = 0$, for the libration limits, on page 281, become:

$$\left. \begin{aligned} \left(\frac{2\pi m_e E / h}{n_1 + n_2 + n_3} \right)^2 \xi^4 + 2m_e E \frac{2n_1 + n_3}{n_1 + n_2 + n_3} \xi^2 &= \left(\frac{n_3 h}{2\pi} \right)^2 \\ \left(\frac{2\pi m_e E / h}{n_1 + n_2 + n_3} \right)^2 \eta^4 + 2m_e E \frac{2n_2 + n_3}{n_1 + n_3 + n_2} \eta^2 &= \left(\frac{n_3 h}{2\pi} \right)^2 \end{aligned} \right\} \quad (29)$$

*This remark concludes the author's representation of the Stark effect which links up directly with the works of Schwarzschild and Epstein and which appeared in the *Physikal. Zeitschr.*, **17**, 506 (1916).

11. Stark Effect according to the Hamilton-Jacobi Method 593

If we multiply these equations by $(2\pi/h)^2$, introduce the standard length

$$a = \frac{h^2}{4\pi^2 m e E}$$

which is analogous to the first Bohr circle of the hydrogen atom, eqn. (7) on page 213, and then use the abbreviations

$$x = \frac{\xi^2}{a(n_1 + n_2 + n_3)}, \quad y = \frac{\eta^2}{a(n_1 + n_2 + n_3)} \quad (30)$$

we get in place of (29)

$$\begin{aligned} x^2 - 2(2n_1 + n_3)x &= -n_3^2, \\ y^2 - 2(2n_2 + n_3)y &= -n_3^2. \end{aligned}$$

Solving these we get

$$\begin{aligned} x &= 2n_1 + n_3 \pm \sqrt{4n_1^2 + 4n_1n_3} = (\sqrt{n_1} \pm \sqrt{n_1 + n_3})^2 \\ y &= 2n_2 + n_3 \pm \sqrt{4n_2^2 + 4n_2n_3} = (\sqrt{n_2} \pm \sqrt{n_2 + n_3})^2 \end{aligned} \quad (31)$$

If we then return to the meaning of x and y in (30) we get as the libration limits in the ξ - and η -co-ordinates

$$\left. \begin{aligned} \sqrt{a} \sqrt{n_1 + n_2 + n_3} = \sqrt{n_1} \pm \sqrt{n_1 + n_3} \\ \sqrt{a} \sqrt{n_1 + n_2 + n_3} = \sqrt{n_2} \pm \sqrt{n_2 + n_3} \end{aligned} \right\} \quad (32)$$

For the sake of illustration we apply this result, say, to the final orbit of the Balmer series $n_1 + n_2 + n_3 = 2$. According to the Tables 27 to 34 on pages 289 to 293 the quantum triplets (002), (101), (011) occur in this case. For the first of these we have by (32)

$$\frac{\xi}{\sqrt{a}} = \frac{\eta}{\sqrt{a}} = \pm 2 \quad (32a)$$

and for the second

$$\frac{\xi}{\sqrt{a}} = \sqrt{2}(1 \pm \sqrt{2}), \quad \frac{\eta}{\sqrt{a}} = \pm \sqrt{2} \quad (32b)$$

The third quantum triplet has the same libration limits as the second, except that ξ and η are interchanged. Since by eqn. (1) on page 279, the co-ordinate parabolas depend only on ξ^2 or η^2 , respectively, the values ± 2 denote one and the same parabola or, in three-dimensional space, one and the same paraboloid. Thus the libration limits denoted by ± 2 coincide and the orbital curve (Kepler ellipse) lies on one and the same paraboloid. In the case (32a) it comes out as the intersection of two such paraboloids situated symmetrically with respect to the nucleus, and is thus merely a circle of the radius $4a$. In the case (32b) the libration limits coincide only for the η -co-ordinate and are different in the ξ -co-ordinate. The corresponding orbital curve lies as a Kepler ellipse on the paraboloid determined by the η -co-ordinate, and, indeed, within that segment which is cut out by the libration limits of the ξ -co-ordinate.

In conclusion, we remark that the development (25) has been extended by Epstein* to the next member, which is quadratic in F , and that the "Stark effect of the second order" corresponding to the quadratic term has also been proved to be present in observations by Takamine and Kokubu when particularly strong fields were used.†

12. The Adiabatic Invariance of Phase-Integrals ‡

(To Chapter V, § 7)

In dealing with adiabatic changes of state we consider a parameter a that enters in some way into the equations of motion of the system (as the length of a pendulum, the position of a point-mass, of an external field of force, and so forth). This parameter is changed in the course of time, but, by condition (1) on page 305, *infinitely slowly (reversibly)*. For every value of a the equations of motion are to remain valid in the form:

$$\frac{dp_k}{dt} = - \frac{\partial H}{\partial q_k}, \quad \frac{dq_k}{dt} = \frac{\partial H}{\partial p_k} \quad . \quad . \quad . \quad (1)$$

where H is the same function of p , q , and a , as when a is kept fixed. We mean this when we demand in condition (2) on page 305 that the adiabatic action is *not to act on the co-ordinates of the system directly*. We shall return below to the condition (3) on page 305 (*unsystematic alteration of a*).

In integrating eqn. (1) in conditionally periodic cases by means of a function of action S whilst a remains constant, S becomes a function of a ; so that if we insert the time change of a , S also becomes a function of t . We derive the phase integrals J and the angular variables w from S , just as in the case of a fixed a :

$$J_k = \oint p_k dq_k = \oint \frac{\partial S}{\partial q_k} dq_k, \quad w_k = \frac{\partial S}{\partial J_k} \quad . \quad . \quad . \quad (2)$$

The question is whether J also becomes a function of t through the intermediate agency of a . If the adiabatic hypothesis is to be right in its assertion that the quantum conditions $J_k = n_k h$ are to be adiabatically invariant, then J must be independent of t .

We find the answer to this question by doing as on page 566, and deriving the canonical equations for J and w . Hereby we are no longer dealing with the special case that (cf. page 566) $F^* = S$ is independent of t . Thus

$$\bar{H} = H$$

no longer holds for the transformed Hamiltonian function H , but

$$\bar{H} = H + \frac{\partial F}{\partial t} \quad . \quad . \quad . \quad (3)$$

by eqn. (20a) on page 545.

* P. Epstein, Ann. d. Phys., **51**, 184 (1916).

† A. Sommerfeld, Ann. d. Phys., **65**, 36 (1921).

‡ The first proof is due to J. M. Burgers, cf. Ann. d. Phys., **52**, 195 (1917), or Amst. Akad., 1917, p. 1055. Here we follow a simpler line of proof, likewise indicated by Burgers, cf. his Dissertation for Leyden, 1919, p. 242.

The relationship between F and F^* is by eqn. (21) on page 546, when $P_k = J_k, Q_k = w_k,$

$$F = F^* - \sum J_k w_k,$$

thus on account of $F^* = S$

$$F = S - \sum J_k w_k = S^* \quad . \quad . \quad . \quad . \quad . \quad (4)$$

[cf. eqn. (38) on p. 566].

In place of eqn. (34) on page 566 we thus get, on account of (3) and (4)

$$\frac{dJ_k}{dt} = - \frac{\partial \bar{H}}{\partial w_k} = - \frac{\partial H}{\partial w_k} - \frac{\partial}{\partial w_k} \frac{\partial S^*}{\partial t} \quad . \quad . \quad . \quad . \quad . \quad (5)$$

The term $\frac{\partial H}{\partial w_k}$ here vanishes because $H,$ regarded as a function of the variables $J_1 \dots J_k, w_1 \dots w_k,$ is independent of $w.$ If, further, we take into account that $S^*,$ as well as $S,$ is dependent on t only through the medium of $a,$ we may set

$$\frac{\partial S^*}{\partial t} = \frac{\partial S^*}{\partial a} \dot{a} = \Phi \dot{a} \quad . \quad . \quad . \quad . \quad . \quad (6)$$

with the notation

$$\Phi = \frac{\partial S^*}{\partial a} \quad . \quad . \quad . \quad . \quad . \quad (7)$$

From (5) and (6) it follows that

$$\frac{dJ_k}{dt} = - a \frac{\partial \Phi}{\partial w_k}, \quad J_k \Big|_0^T = - \int_0^T \dot{a} \frac{\partial \Phi}{\partial w_k} dt \quad . \quad . \quad . \quad . \quad . \quad (8)$$

In addition we now take into consideration that by our condition (3) on page 305 a is to be changed unsystematically, that is, not in phase with the course of motion of the system. We act in agreement with this if, for example, we make \dot{a} constant and write in place of (8):

$$J_k \Big|_0^T = - \dot{a} \int_0^T \frac{\partial \Phi}{\partial w_k} dt \quad . \quad . \quad . \quad . \quad . \quad (9)$$

$\Phi,$ just like S^* (cf. p 567), is a periodic function of the w 's, and may thus be represented as a Fourier series in terms of the w 's. Hence $\partial \Phi / \partial w$ is a Fourier series without a constant term. Since the $w_k = \nu_k t + \delta_k$ [eqn. (35) on p. 566] are linear functions of the t 's, the integration with respect to t on the right-hand side of (9) may be carried out in the Fourier series, and furnishes a value, which even if T increases to any arbitrary extent, remains below a certain limit.

The circumstance that the vibration numbers ν_k themselves still depend on $a,$ and thus also on $t,$ causes no essential alteration in this conclusion, but entails only that the value of the integral becomes changed by terms of the value $\dot{a}T.$ But $\dot{a}T$ denotes the total change of the parameter a in the interval of time T and, as such, is finite. Hence on the right-hand side of (9) \dot{a} is multiplied by a quantity that is finite even when $T = \infty.$

In the limit $\dot{a} = 0$ and $T = \infty$ the right-hand side of (9) becomes equal to zero, that is J becomes constant.

On the other hand, however, the above inference falls to the ground if in the course of the adiabatic change the system passes through a degenerate state. Then on account of the relation $\sum s_k \nu_k = 0$ [eqn. (42) on p. 568] constant terms would occur in the Fourier series, and in the process of integration with respect to t they would yield terms of the order T . Thus the adiabatic invariance for all quantities J holds only in the case of general, not degenerate, systems.

13. Concerning the Spectra of Atoms not of the Hydrogen Type. Effect of the Supplementary Atomic Field

(To Chapter IV, § 6, p. 232)

We schematise the supplementary field of the electronic configuration belonging to the body of the atom by regarding it as a *pure central field varying with the time*. Thus we assume that its action on the outer "leaping electron" (*Außelektron*) is:

$$E_{pot} = -\frac{eM}{r} + V, \quad V = \frac{e^2}{r} \left[c_1 \left(\frac{a}{r} \right)^2 + c_2 \left(\frac{a}{r} \right)^3 + \dots \right] \quad (1)$$

We have assumed V to be expressed so that the "constants of the atomic field," c_1 and c_2 are pure numbers; a denotes a standard of length for the purpose of comparison, and we shall choose it appropriately as the radius of the first Bohr circle [cf. eqn. (7) on page 213]

$$a = \frac{\hbar^2}{4\pi^2 m e^2} \cdot \dots \quad (2)$$

In assuming that the field is central, we make the orbit of the "leaping electron" plane. We determine its position in this plane by polar co-ordinates r, ϕ . Its kinetic energy expressed in terms of the momenta p_r, p_ϕ , is:

$$E_{kin} = \frac{1}{2m} \left(p_r^2 + \frac{1}{r^2} p_\phi^2 \right)$$

The partial differential equation of the motion is then:

$$\left(\frac{\partial S}{\partial r} \right)^2 + \frac{1}{r^2} \left(\frac{\partial S}{\partial \phi} \right)^2 = 2m \left[W + \frac{eE}{r} - c_1 \frac{e^2}{r} \left(\frac{a}{r} \right)^2 - c_2 \frac{e^2}{r} \left(\frac{a}{r} \right)^3 + \dots \right] \quad (3)$$

We integrate it with regard to ϕ by assuming

$$\frac{\partial S}{\partial \phi} = p = \text{const.}$$

From the quantum condition,

$$J_\phi = \int_0^{2\pi} \frac{\partial S}{\partial \phi} d\phi = n\hbar,$$

we then get

$$p = \frac{\partial S}{\partial \phi} = \frac{n\hbar}{2\pi} \cdot \dots \quad (4)$$

As a result of this (3) becomes

$$\frac{\partial S}{\partial r} = \sqrt{A + 2\frac{B}{r} + \frac{C}{r^2} + \frac{D_1}{r^3} + \frac{D_2}{r^4} + \dots}$$

$$A = 2mW, \quad B = meE, \quad C = -\frac{n^2\hbar^2}{4\pi^2}$$

$$D_1 = -2mc_1e^2a^2, \quad D_2 = -2mc_2e^2a^3$$

If we had added a term in $1/r^2$ to the expression assured for V in eqn. (1), this would have changed only the meaning of the coefficients C, but not the form of eqn. (5). That is why we began the expansion of V with the power $1/r^3$. The radial quantum condition

$$J_r = \oint \frac{\partial S}{\partial r} dr = n'h$$

now gives us

$$J = \oint \sqrt{A + 2\frac{B}{r} + \frac{C}{r^2} + \frac{D_1}{r^3} + \frac{D_2}{r^4}} dr = n'h \quad (6)$$

if we strike out the higher coefficients of the expansion. The integration is to be taken along a complex path in the r -plane around the branch-points r_{min} and r_{max} of the integrand.

The integral (6) is to be carried out in three different stages of approximation, cf. (c), (d), and (e) of Note 6.

For a first approximation ($D_1 = D_2 = 0$) we obtained in eqn. (10) of Note (6c)

$$J_r = -2\pi i \left(\sqrt{C} - \frac{B}{\sqrt{A}} \right).$$

From this we deduce, as in eqns. (8), (9), and (10) of Note 8 :

$$W = -\frac{R\hbar}{(n + n')^2} \quad (7)$$

where R = Rydberg's number. According to our earlier remarks, the quantity $-W/\hbar$ denotes the "term." In conformity with this, our first approximation gives us the *Balmer term*, namely, in the notation of eqn. (2a) on page 316, if we set $m = n + n'$:

$$(m, 0) = \frac{R}{m^2} \quad (7a)$$

For our second approximation ($D_1 \neq 0, D_2 = 0$) we obtained in eqn. (16), Note (6d) :

$$J_r = -2\pi i \left(\sqrt{C} - \frac{B}{\sqrt{A}} - \frac{1}{2} \frac{BD_1}{C\sqrt{C}} \right).$$

By (6) we set this equal to $n'h$, and remember the value of $\sqrt{C} = -\frac{i\hbar}{2\pi}$ (vide the concluding remark of Note 6c). We then get

$$(n + n')\hbar - \frac{(2\pi)^4 BD_1}{2n^3\hbar^3} = 2\pi i \frac{B}{\sqrt{A}}$$

In view of the values of B and D₁ in (5), and of a in (2), it follows that

$$n + n' + k = \frac{2\pi imeE}{h\sqrt{\Lambda}}, \quad k = \frac{(2\pi)^4 m^2 e^3 E a^2}{n^3 h^4} c_1 = \frac{E c_1}{e n^3} \quad (8)$$

and hence, with A = 2mW

$$W = \frac{-Rh}{(n + n' + k)^2} \quad (9)$$

k is dependent on n and on the nature of the supplementary field, but independent of n', thus for a fixed n it denotes a constant of the series. Accordingly, our second approximation leads to the form of the *Rydberg term* [cf. eqn. (2) on p. 316], namely, if m = n + n', to:

$$(m, k) = \frac{R}{(m + k)^2} \quad (9a)$$

For our third approximation (D₁ ≠ 0, D₂ ≠ 0) we obtained in eqn (21) of Note (6e):

$$J_r = -2\pi i \left\{ \sqrt{C} \cdot \frac{B}{\sqrt{\Lambda}} - \frac{1}{2} \frac{B}{C\sqrt{C}} \left(D_1 - \frac{3}{2} D_2 \frac{B}{C} + \frac{15}{8} D_1^2 \frac{B}{C^2} \right) - \frac{1}{4} \frac{\Lambda}{C\sqrt{C}} \left(D_2 - \frac{3}{4} \frac{D_1^2}{C} \right) \right\}$$

If we insert in this the value $\sqrt{C} = -\frac{inh}{2\pi}$ as well as the values of B, D₁, D₂ from (5), and, as in (8), simplify the resulting expressions by using the meaning of a, we get

$$J_r = -nh + \frac{2\pi imeE}{\sqrt{\Lambda}} - \frac{h}{n^3} \frac{E}{e} \left(c_1 + \frac{3}{2} \frac{c_2}{n^2} \frac{E}{e} - \frac{15}{4} \frac{c_2^2}{n^2} \frac{E}{e} \right) - \frac{\Lambda}{4mR} \left(c_2 - \frac{3}{2} \frac{c_1^2}{n^2} \right) \quad (10)$$

We write κ2m as an abbreviation of Λ in the last term. Then

$$R\kappa = -\frac{1}{2} \left(c_2 - \frac{3}{2} \frac{c_1^2}{n^2} \right) \quad (11)$$

For the penultimate term of (10) we write the abbreviation -kh; k now has the significance:

$$k = \frac{1}{n^3} \frac{E}{e} \left(c_1 + \frac{3}{2} \frac{c_2}{n^2} \frac{E}{e} - \frac{15}{4} \frac{c_2^2}{n^2} \frac{E}{e} \right) \quad (12)$$

(12), as should be, passes over into the k of the approximation (8), if c₂ and c₁ are neglected.

k and κ are again independent of n', but dependent on n and on the nature of the supplementary field.

With these abbreviations (10) is written

$$J_r = -nh + \frac{2\pi imeE}{\sqrt{\Lambda}} - kh + \frac{\kappa\Lambda}{2m} \quad (13)$$

If, by (6), we set this equal to $n'h$, we get

$$n + n' + k - \frac{\kappa A}{2mh} = \frac{2\pi imeE}{h\sqrt{A}}$$

In view of the meaning of A , cf. eqn. (5), the energy comes out as :

$$W = - \frac{Rh(E/e)^2}{\left(n + n' + k - \kappa \frac{W}{h}\right)^2} \quad (14)$$

If, finally, we pass on to the term $-W/h$, and call it (m, k, κ) in accordance with page 316, where we again set $n + n' = m$, we find from (14) that

$$(m, k, \kappa) = \frac{R(E/e)^2}{\left[m + k + \kappa(m, k, \kappa)\right]^2} \quad (15)$$

Hence in the third approximation we are led straight to Ritz's form of the series term. To get back to the ordinary nomenclature it is only necessary to identify k, κ

with s, σ	for $n = 1$. . .	II. N.S.,
,, p, π	,, $n = 2$. . .	H.S.,
,, d, δ	,, $n = 3$. . .	I. N.S.,
, b, β	,, $n = 4$. . .	Bergmann series,

for which detailed reasons are given in the text.

The development of our argument clearly shows that Ritz's form of the series term is also only an approximation, and indicates the way in which we are to look for an improvement of Ritz's representation in a fourth, fifth, . . . approximation. These all come under the general form :

$$(m, k, \kappa, \kappa', \dots) = \frac{R(E/e)^2}{\left[m + k + \kappa(m, k, \dots) + \kappa'(m, k, \dots)^2 + \kappa''(m, k, \dots)^3 + \dots\right]^2} \quad (16)$$

in which κ', κ'', \dots are new constants.

If we set $E = e$ in this expression and also in (11) and (12), we have the case of an atom that is neutral as a whole, one in which the outer electron is acted on by an atomic trunk which has a single charge. If, however, we are dealing with a charged atom which has lost one electron and if this is excited optically by removing one of its remaining electrons to a greater or lesser extent, the outer electron is confronted by an atomic trunk bearing a double charge. Consequently E is now equal to $2e$. On account of the factor $(E/e)^2$ in the numerator of the term, $4R$ now occurs in place of R as the Rydberg number. The meaning of the constants k, κ, \dots alters correspondingly, and we write k^*, κ^* instead of them for the ionised atom. For instance, we should get

$$k^* = 2k \quad . \quad . \quad . \quad . \quad . \quad (17)$$

as a first approximation by (8) so long as we assume that the constant c_1 in the expansion of the potential V has appreciably the same value for the ionised atom as for the neutral atom.

We thus get as the term representation for the ionised atom :

$$(m, k^*, \dots) = \frac{4R}{[m + k^* + \kappa^*(m, k^*, \dots) + \dots]^2} \quad (18)$$

§ 6 in Chapter VI is founded on this form of representation of the term. A closer investigation (cf. J. Weinacht, Dissertation, Munich, unpublished) of the relative magnitudes that presumably occur in the atom has disclosed the surprising result that the decrease, or under certain circumstances the increase of the constant c of the atomic field is so gradual that the expansions used above are not always convergent (namely, never in the case of the s -term, only quite exceptionally in that of the p -term, often in that of the d -term, and always in that of the b -term; in the spark spectrum, the convergence would be still worse). Whereas in our above development we had assumed the members with D_1, D_2, \dots to be arbitrarily small quantities, the atomic radii are in reality fixed in accordance with quanta, and are of such magnitude that the path of integration chosen on page 552 for the convergence in many cases becomes impossible. How does it happen then that Ritz's formula, that is, a power series which is cut off as early as at the second member, represents the results of observation so well on the whole? Obviously, the form of our development must remain, even if the special numerical values seem to make them illusory. One way of accounting for this (cf. Weinacht, *loc. cit.*) is to expand, not in powers of the supplementary field but in powers of a supplementary field that is modified to meet the requirements of convergency. For this purpose we reduce the supplementary field by means of the quadratic expression

$$a + 2\frac{\beta}{r} + \frac{\gamma}{r^2},$$

which we take in conjunction with the quadratic expression

$$A + 2\frac{B}{r} + \frac{C}{r^2}$$

and in the interval of integration we in this way minimise as far as possible by our choice of the disposable parameters a, β, γ , the quantity in which we make our expansion, whilst at the same time increasing the principal quadratic terms. By this method the form of the expansion clearly remains preserved, that is, the dependence on the member-number of the series, but the significance of the number coefficients and the consequent inference concerning the convergence becomes changed.

Nor must we overlook that the assumption of a central supplementary field that is invariable in time in reality denotes a process of averaging that may be inadmissible. To this there becomes added the difficult question of the reaction of the outer electron on the atomic trunk. These circumstances are quite sufficient to explain why (cf. p. 328) the observed values of the spectral constants k, κ and their dependence on the azimuthal quantum number cannot be given with satisfactory numerical agreement by our theory. It is so much the more gratifying that, in spite of this, there is a general agreement with the form of the spectral formula.

14. The Original Bohr Models of He, H₂, and H₂⁺ and their Ionisation Potentials

The following calculations concern models that are indeed interesting from the historical aspect but that cannot be maintained empirically and theoretically. They have already been criticised on pages 69 and 79 of Chapter II. It is scarcely necessary to state that Bohr* furnished not only the original construction of these models but also the essential ideas for their criticism later.

(a) **The Neutral He-atom.** Fig. 19 on page 69 represents Bohr's original idea of the He-atom. We proceed to calculate the radius *a* of the orbit and the angular velocity ω of the electrons in their "one-quantum" motion.

From the Coulomb attractive force $2e^2/a^2$ of the nucleus we must subtract the Coulomb repulsion $e^2/4a^2$ of the "second" electron acting on the "first" electron. Accordingly the classical condition is:

$$m\omega^2 a^3 = \frac{2e^2}{a^2} - \frac{e^2}{4a^2} = \frac{7}{4} \frac{e^2}{a^2} \quad \dots \quad (1)$$

Further, we have the quantum condition for the rotator applied separately to the "first" or the "second" electron

$$m\omega^2 a^3 = \frac{h}{2\pi} \quad \dots \quad (2)$$

From (1) and (2) we get by division

$$a\omega = \frac{7}{4} \frac{2\pi e^2}{h} \quad \dots \quad (3)$$

The sum of the kinetic energies of both electrons is:

$$m(a\omega)^2 = \frac{49}{8} \frac{2\pi^2 m e^4}{h^2} = \frac{49}{8} R/h.$$

The total energy of the Bohr He-atom is just as great but negative (cf. Note 5), thus

$$W = - \frac{49}{8} R/h \quad \dots \quad (4)$$

The energy of the simply ionised atom He⁺ comes out very simply. He⁺ is of the hydrogen type and has a double nuclear charge. Hence its energy is four times that of the hydrogen atom (cf. p. 214) that is, it is equal to

$$- 4R/h \quad \dots \quad (5)$$

Hence the transformation of the neutral into the simply ionised He-atom requires, by (4) and (5), the work

$$A = - 4R/h + \frac{49}{8} R/h = \frac{17}{8} R/h \quad \dots \quad (6)$$

This would be the ionisation potential of the neutral He-atom according to Bohr's He-model. Since the ionisation potential of the hydrogen atom as well as its energy is given by *R/h* and amounts to 13.53 volts

* Cf. for example his lecture in Berlin, *Zeitschr. f. Phys.*, **2**, 468 (1920).

[cf. eqn. (3) on p. 342] the ionisation potential of He would be, likewise expressed in volts:

$$J = \frac{1}{8} \cdot 13 \cdot 53 = 28 \cdot 75 \text{ volts} \quad (7)$$

Experiment has not confirmed this value, but has yielded the smaller value (cf. pp. 344 and 350, Table 38):

$$J = 25 \cdot 3$$

which has been found by different methods and is certified in various ways. Thus Bohr's He-model cannot be correct.

In the same way the following value of the ionisation potential of the second order (work necessary to detach both electrons) for the helium nucleus

$$\frac{4}{8} \cdot 13 \cdot 53 = 82 \cdot 9 \text{ volts}$$

is too great and is in contradiction with the results of experiment [cf. eqn. (5) on p. 344].

The fact that the true value of the ionisation voltage comes out *less* than that calculated from the model is particularly noteworthy. If it were *greater* we would say: Bohr's model is, indeed, a possible arrangement of the structural elements of the He-atom but it is not the most stable one. We should have to think out another arrangement that would be more permanent as regards retaining its energy, and that would thus require more work to bring about its disintegration. But, as it is, we must say that, in spite of its greater stability as regards energy Bohr's He-model is not a durable arrangement of the structural elements of He. Besides *energetic* stability *dynamic* stability is of importance. The latter is best investigated by the method of small oscillations.

This has already been done for general ring systems by Nicholson.* The following is found for He-models in particular. Of the six degrees of freedom that belong to the model if we assume the nucleus to be immovable, one is unstable. For if we strike both electrons in their orbital plane in the same sense at right angles to the line connecting them, a "fundamental vibration" of the system occurs, whereby the electrons do not tend back to their position of rest, but move away from them exponentially.

We thus see that the dynamic instability of Bohr's He-atom outweighs the energetic stability, and we understand why the real He-atom which must, of course, be stable can appear energetically less stable than Bohr's model.

(b) **The H₂-molecule.** Bohr's model of the H₂-molecule is represented in Fig. 22, page 76. From the conditions of equilibrium we obtained the following relation between the radius a and the angular velocity ω of its two electrons [eqn. (21) on p. 78]:

$$ma^3\omega^2 = \frac{3\sqrt{3}-1}{4} e^2 \quad (8)$$

If we combine with this the quantum condition (2), applied separately to each of the two electrons, we get from (2) and (8) by eliminating ω

$$a = \frac{h^2}{4\pi^2 me^2} \frac{4}{3\sqrt{3}-1} = 0 \cdot 95 a_1 \quad (9)$$

* Monthly Notices, 72, 1912.

Thus the diameter of the hydrogen molecule would be somewhat less than the diameter $2a_1$ (p. 72) of the first Bohr circle in the hydrogen atom.

We next calculate the energy W of the hydrogen molecule. Its potential energy is made up of three parts: the potential energy of the two nuclei V_K , that of the two electrons V_E and that of the mutual energy of the nuclei and the electrons V_{KE} .

By eqn. (17) on page 77 we have

$$\left. \begin{aligned} V_K &= \frac{e^2}{2b} = \frac{e^2}{2a} \sqrt{3}, & V_E &= \frac{e^2}{2a} \\ V_{KE} &= -\frac{4e^2}{\sqrt{a^2 + b^2}} = -\frac{2\sqrt{3}e^2}{a} \end{aligned} \right\} \quad (10)$$

$$E_{pot} = -\frac{e^2}{2a}(3\sqrt{3} - 1) \quad (11)$$

By substituting (9) in (11) it follows that

$$E_{pot} = -\frac{8\pi^2 me^4}{h^2} \left(\frac{3\sqrt{3} - 1}{4} \right)^2$$

The kinetic energy of the revolving electrons in the hydrogen molecule is also half as great as the potential energy (cf. Note 5). Hence the *total energy* that remains is:

$$W = \frac{4\pi^2 me^4}{h^2} \left(\frac{3\sqrt{3} - 1}{4} \right)^2 = -2.20R_h \quad (12)$$

We next determine the *work of dissociation* and the *dissociation potential* of the hydrogen molecule. After the dissociation both hydrogen atoms are separated from each other. We assume both initially to be in their most stable state, that is, in the state of the first Bohr circle. Their energy is then

$$2W_1 = -2R_h.$$

Hence the work of dissociation is

$$\Lambda = 2W_1 - W = 0.20R_h \quad (13)$$

Thus for a grammol of hydrogen gas it would be:

$$\frac{\Lambda L}{Q} = 0.20 \frac{R_h L}{Q} = 6.1 \cdot 10^4 \text{ cal.} \quad (14)$$

where $Q = 4.19 \cdot 10^7$ ergs./cal. denotes the mechanical equivalent of heat, and $L = 6.07 \cdot 10^{23}$ denotes Loschmidt's number per grammol, or Avogadro's number. This value is appreciably smaller than a value obtained by Langmuir* from observation (certainly somewhat indirect) amounting to $8.4 \cdot 10^4$ cal.

Passing on to the work of dissociation, let us express (13) in volts, and we get, corresponding to (7)

$$D = 0.20 \cdot 13.53 = 2.71 \text{ volts} \quad (15)$$

This value, too, is appreciably smaller than the value obtained from observations [eqn. (4) on p. 343] $D = 3.5$ volts.

* Langmuir, Journ. Amer. Chem. Soc., 34, 860 (1912).

14. Original Bohr Models and their Ionisation Potentials 605

The electron, on the other hand, is acted on by: 1. the centrifugal force $ma\omega^2$; 2. the attraction due to both nuclei, which furnishes the component $2e^2a/(a^2 + b^2)^{3/2}$ in the direction of 1. Thus we have the dynamic equation:

$$ma^3\omega^2 = \frac{2e^2}{\left[1 + \left(\frac{b}{a}\right)^2\right]^{3/2}} = \frac{e^2}{2}(\sqrt[3]{16} - 1)^3$$

In addition, there is the quantum equation:

$$ma^2\omega = \frac{h}{2\pi}$$

and as the quotient of these two we get

$$a\omega = \frac{\pi e^2}{h} \quad 1)^3 \quad \dots \quad (21)$$

From this we get for the kinetic energy of the electron

$$E_{kin} = \frac{\pi^2 m e^4}{2h^2} (\sqrt[3]{16} - 1)^3 = (\sqrt[3]{16} - 1)^3 \frac{R_h}{4} = 0.88R_h \quad (22)$$

According to Note 5 the total energy W is of the same value but negative.

This total energy $W = -0.88R_h$ is *greater* than the energy $W_1 = -R_h$ of the dissociated state, in which the ion is resolved into a neutral H-atom and an H-nucleus.

The H_2^+ -ion is *unstable energetically*; it can dissociate into $H + H^+$, giving up energy. At the same time it follows from this for the ionisation of the H_2 -molecule that if this happens in the sense of the scheme (19), it requires a greater ionisation potential than if it proceeds according to the scheme (16). This conclusion is independent of any assumptions about the model of the neutral H_2 and also remains preserved if we pass from the H_2^+ -molecule considered so far to a more general molecule.

The great advantage that the H_2^+ -ion has above the neutral H_2 -molecule in analytical respects is that in the former we have mathematical control of the most general configurations. They all fall under the category of Jacobi's problem of two fixed centres (cf. p. 279) and are of a conditionally periodic character. As a matter of fact, on account of the predominant mass of the two nuclei we may assume them fixed during the motion of the electron; their distance apart is to be chosen so that the resulting force at the nuclei in the time-mean vanishes.

On page 79 we stated that as regards these more general motions Bohr's circular orbit in the median plane of the nuclei is *more stable* energetically*. But we must add a *correction* at this stage. The circular orbit is indeed stable energetically, but *unstable dynamically*. Bohr emphasised this as early as 1913.† And, indeed, in this case it is an impact, on the electron, perpendicular to the median plane that causes the spontaneous decay of the model. *Consequently Bohr's model of the H_2^+ -ion is untenable.* Here, too, just as in the case of the model of the

* Cf. Pauli, Ann. d. Phys., 1922.

† Cf. Gesammelte Abhandl., p. 61.

He-atom and of the H_2 -molecule, it is shown that the *dynamic stability* plays the deciding part as compared with *energetic stability*.

That there is a stable configuration of the H_2^+ -ion among the more general types of motion is proved beyond objection by experiments with canal rays. This dynamically stable configuration is *energetically unstable* both in comparison with the circular orbit model of H_2^+ , and to a still greater degree in comparison (cf. above) with the dissociated state $H + H^+$. But this does not prevent the configuration in question from being lasting if the impacts are sufficiently small; only under the effect of greater impacts would it be transformed into the state of minimum energy, that is, finally, into the dissociated state.

15. Hamilton's Theory in the Mechanics of Relativity

(To Chapter VI, § 1)

In the theory of relativity the components of momentum are [vide eqn. (24) on p. 463]

$$m\dot{x} = \frac{m_0}{\sqrt{1 - \beta^2}} \dot{x}, \quad m\dot{y} = \frac{m_0}{\sqrt{1 - \beta^2}} \dot{y}, \quad m\dot{z} = \frac{m_0}{\sqrt{1 - \beta^2}} \dot{z} \quad (1)$$

In ordinary mechanics they are represented as derivatives of the kinetic energy with respect to the corresponding components of the velocity. This does not hold in the theory of relativity. We can confirm at once, however, that they are derivatives of the following quantity with respect to \dot{x} , \dot{y} , \dot{z} :

$$F = - m_0 c^2 \sqrt{1 - \beta^2} \quad (2)$$

We may designate F as the "kinetic potential," an expression due to Helmholtz. If we number the momentum components successively as $p_1, p_2, \dots, p_k, \dots$, more than one point-mass being present if so required, and if we call the corresponding position co-ordinates $q_1, q_2, \dots, q_k, \dots$, the corresponding velocity co-ordinates $\dot{q}_1, \dot{q}_2, \dots, \dot{q}_k, \dots$, then the relation in question between F and the momentum components may be summarised thus:

$$\delta F = \sum p_k \delta \dot{q}_k \quad (3)$$

[When several point-masses are present we must clearly take F as standing for the sum of expressions of the form (1) for all the point-masses.]

In contrast with F the relativistic expression of the kinetic energy [cf. p. 465, eqn. (27)] is, in particular, for one point-mass

$$E_{kin} = m_0 c^2 \left(\frac{1}{\sqrt{1 - \beta^2}} - 1 \right) \quad (4)$$

Since, expressed in terms of p and q , (1) is

$$p = \frac{m_0}{\sqrt{1 - \beta^2}} \dot{q},$$

it follows that

$$\sum p \dot{q} = \frac{m_0 c^2 \beta^2}{\sqrt{1 - \beta^2}} \quad (5)$$

From the latter we can immediately confirm the relation

$$F = \sum p\dot{q} - E_{kin} + \text{const.}, \quad \text{const.} = m_0c^2 \quad (6)$$

Since in classical mechanics $\sum p\dot{q}$ is equal to twice E_{kin} [eqn. (5) on p. 541], but not in the mechanics of the theory of relativity, we recognised that in the classical case F must be identical with E_{kin} (except for a constant), but must differ from it in the relativistic case.

We now go through the developments of Notes 4 and 7, which led to Hamilton's theory. Written in the form (9) on page 542, d'Alembert's principle remains valid, likewise the eqn. (11) that follows on it, if we replace E_{kin} in it by F . Consequently eqn. (12) also remains in force, except that now the "Lagrange function" is to mean :

$$L = F - E_{pot} \quad (7)$$

This is the only change which has to be made in our earlier developments for the sequel. The function of action S is defined by this L by means of eqn. (4) on page 556 :

$$\int_0^t L d\tau = S - Wt \quad (8)$$

and the relation

$$p_k = \frac{\partial S}{\partial q_k} \quad (9)$$

holds not only for rectangular, but also for arbitrary co-ordinates p_k, q_k . With the altered meaning of E_{kin} , the energy law, as compared with that of classical mechanics, has the form

$$E_{kin} + E_{pot} = W \quad (10)$$

That is, not our F , but the relativistic value of E_{kin} (or, as circumstances demand, the sum of such values if several point-masses are present) occurs here. If we set the left-hand side of (10), expressed as a function of p_k and q_k , equal to H ("Hamilton's function"), the partial differential equation of relativistic mechanics becomes, in formal agreement with eqn. (10) on page 558 :

$$H\left(\frac{\partial S}{\partial q_k}; q_k\right) = W \quad (11)$$

All further inferences, in particular those concerning the separation of variables, thus hold unchanged also in the relativistic case. They will be used in the next note.

It is to be observed that our translation of results from classical to relativistic mechanics was effected so smoothly only because we wrote d'Alembert's principle from the very outset in the rational form (9) on page 542, in which the changes of momentum \dot{p}_k , and not the products of the mass by the acceleration $m_k\ddot{q}_k$ occurred. When written in the latter form the inertial resistances do not allow themselves to be generalised relativistically. Further, we must note that the quantity L here defined by (7) may, on account of (6), also be written :

$$L = \sum p\dot{q} - E_{kin} - E_{pot} = \sum p\dot{q} - H \quad (12)$$

This relation, which we have already encountered in eqn. (13a) on page 543 on the basis of classical mechanics, is thus not bound to the condition that H is a quadratic function of the p 's. As a matter of fact it holds quite generally and can serve to define the Hamiltonian function H , and, further, to set up the canonical equations, if the problem was originally present in the form involving variation, that is, if L was originally known. Conversely, if the problem was originally given in canonical equations, it can serve to calculate L and to transform the problem into the form involving variation.

16. Quantising of Relativistic Elliptic Motion by the Method of Separation of Variables

(To Chapter VIII, § 2)

As in Note 8, so also in the relativistic Kepler problem, we require a minimum of calculation and thought if we start out from the partial differential equation of mechanics and calculate the moduli of periodicity of the function of action as complex integrals.

By eqn. (27) on page 465 the energy equation is :

$$E_{kin} + E_{pot} = m_0 c^2 \left(\frac{1}{\sqrt{1 - \beta^2}} - 1 \right) - \frac{eE}{r} = W$$

(where E denotes the nuclear charge) or

$$\frac{1}{\sqrt{1 - \beta^2}} = 1 + \frac{W + \frac{eE}{r}}{m_0 c^2} \quad (1)$$

Now, on account of the meaning of β^2 and in view of eqn. (7) on page 469 :

$$\beta^2 = \frac{1}{c^2} (\dot{r}^2 + r^2 \dot{\phi}^2) = \frac{1}{c^2 m_0^2} \left(p_r^2 + \frac{1}{r^2} p_\phi^2 \right)$$

or, on account of $m = m_0 / \sqrt{1 - \beta^2}$:

$$\frac{\beta^2}{1 - \beta^2} = \frac{1}{c^2 m_0^2} \left(p_r^2 + \frac{1}{r^2} p_\phi^2 \right)$$

$$\frac{1}{1 - \beta^2} = 1 + \frac{1}{c^2 m_0^2} \left(p_r^2 + \frac{1}{r^2} p_\phi^2 \right).$$

Inserted in (1) this gives

$$1 + \frac{1}{c^2 m_0^2} \left(p_r^2 + \frac{1}{r^2} p_\phi^2 \right) = \left(1 + \frac{W + \frac{eE}{r}}{m_0 c^2} \right)^2$$

$$p_r^2 + \frac{1}{r^2} p_\phi^2 = 2m_0 W + \frac{2m_0 eE}{r} + \frac{1}{c^2} \left(W + \frac{eE}{r} \right)^2 \quad (2)$$

Hence we get the partial differential equation [cf. the preceding note, eqn. (11)]:

$$\left(\frac{\partial S}{\partial r}\right)^2 + \frac{1}{r^2} \left(\frac{\partial S}{\partial \phi}\right)^2 = 2m_0 W + \frac{2m_0 e E}{r} + \frac{1}{c^2} \left(W + \frac{e E}{r}\right)^2 \quad (3)$$

The last term on the right is the relativistic supplementary term, which distinguishes this equation from eqn. (2) in Note 8.

The equation allows itself to be separated in the co-ordinates r and ϕ (and *only* in these). Since ϕ is cyclic, the law of areas

$$\frac{\partial S}{\partial \phi} = \text{const.} = \nu$$

holds, and gives us the azimuthal quantum condition

$$J_\phi = 2\pi\nu = nh, \quad \frac{\partial S}{\partial \phi} = \frac{nh}{2\pi}$$

Eqn. (3) changes into

$$\frac{\partial S}{\partial r} = \sqrt{A + 2\frac{B}{r} + \frac{C}{r^2}} \quad (4)$$

$$\left. \begin{aligned} A &= 2m_0 W + \frac{W^2}{c^2} = m_0^2 c^2 \left\{ \left(1 + \frac{W}{m_0 c^2}\right)^2 - 1 \right\} \\ B &= m_0 e E + \frac{e E W}{c^2} = m_0 e E \left(1 + \frac{W}{m_0 c^2}\right) \\ C &= \frac{n^2 h^2}{4\pi^2} + \frac{e^2 E^2}{c^2} - \frac{n^2 h^2}{4\pi^2} \left(1 - \frac{\alpha^2}{n^2} \frac{E^2}{c^2}\right) \end{aligned} \right\} \quad (4a)$$

The last of these results from the meaning of α , cf. eqn. (8) on page 213. The radial quantum condition which is to be calculated from (4) differs neither in form nor in content from those contained in eqns. (6) and (7) of Note 8, and hence gives us

$$-2\pi i \left(\sqrt{C} - \frac{B}{\sqrt{A}} \right) = n' h \quad (5)$$

As a consequence of the present meaning of A, B, C in (4a) we, however, have

$$\begin{aligned} -2\pi i \sqrt{C} &= -nh \sqrt{1 - \frac{\alpha^2}{n^2} \left(\frac{E}{c}\right)^2}, \\ \frac{B}{\sqrt{A}} &= \frac{eE}{c} \left\{ 1 - \left(1 + \frac{W}{m_0 c^2}\right)^{-2} \right\}^{-1/2}. \end{aligned}$$

Eqn. (5) then becomes

$$\frac{2\pi i e E}{c} \left\{ 1 - \left(1 + \frac{W}{m_0 c^2}\right)^{-2} \right\}^{-1/2} = \left[n' + \sqrt{n^2 - \alpha^2 \left(\frac{E}{c}\right)^2} \right] h.$$

After division by h the expression before the bracket on the left-hand side is $ia \frac{E}{e}$; if we square both sides of the last expression we get

$$1 - \left(1 + \frac{W}{m_0 c^2}\right)^{-2} = - \left[n' + \sqrt{n^2 - a^2 \left(\frac{E}{e}\right)^2} \right] \left(a \frac{E}{e} \right)^2$$

$$1 + \frac{W}{m_0 c^2} = \left\{ 1 + \frac{\left(a \frac{E}{e} \right)^2}{\left[n' + \sqrt{n^2 - a^2 \left(\frac{E}{e}\right)^2} \right]^2} \right\}^{-1/2} \quad (6)$$

Here we have found the final representation of the energy for the relativistic Kepler ellipse, in agreement with eqn. (23) on page 472, which we communicated there as a generalisation of the formula for the circular orbit. The method by which it was reached was not the slightest degree longer than that in Note 8 for the corresponding non-relativistic problem. It is truly a royal road for quantum problems.

If we wish to inform ourselves about the form of the orbital curve in addition to its energy, then by Note 7, eqn. (44) we should have to calculate the function of action S , and differentiate with respect to its integration constants. We, however, attain our object more simply thus.

By eqn. (7) on page 469

$$\frac{p_r}{p_\phi} = \frac{m\dot{r}}{m r^2 \dot{\phi}} = \frac{1}{r^2} \frac{dr}{d\phi} = - \frac{ds}{d\phi}, \quad (7)$$

where we have set

$$s = \frac{1}{r}. \quad (8)$$

By placing $p_\phi^2 = p^2$ outside the brackets on the left-hand side of eqn. (2) we get, in consequence of (7) :

$$p^2 \left[s^2 + \left(\frac{ds}{d\phi} \right)^2 \right] = 2m_0 W + 2m_0 e E s + \frac{1}{c^2} (W + e E s)^2.$$

It is convenient to differentiate this equation with respect to ϕ :

$$p^2 \left(s + \frac{d^2 s}{d\phi^2} \right) \frac{ds}{d\phi} = m_0 e E \left\{ 1 + \frac{1}{m_0 c^2} (W + e E s) \right\} \frac{ds}{d\phi}.$$

By cancelling $ds/d\phi$ on both sides and taking the terms involving s over to the left, we get the following *linear* differential equation for s :

$$\frac{d^2 s}{d\phi^2} + s \left(1 - \frac{e^2 E^2}{p^2 c^2} \right) = \frac{m_0 e E}{p^2} \left(1 + \frac{W}{m_0 c^2} \right). \quad (9)$$

Its general integral is

$$s = A \cos \gamma \phi + B \sin \gamma \phi + C \quad (10)$$

Here A and B are constants of integration ; γ has the significance :

$$\gamma^2 = 1 - \frac{e^2 E^2}{p^2 c^2} \quad (11)$$

in agreement with eqns. (2) and (3) on page 467. The significance of C , with which we are not specially concerned, is

$$C = \frac{m_0 e E}{\gamma^2 p^2} \left(1 + \frac{W}{m_0 c^2} \right).$$

Eqn. (10) agrees with eqn. (1) on page 467, except that the latter is written somewhat more specially.

The occurrence of γ in (10) brings about, as we saw on page 467, the motion of the perihelion of the Kepler ellipse. We proceed to calculate the advance $\Delta\phi$ of the perihelion as defined in eqn. (4) on the page mentioned. Since γ^2 differs very little from (1), we get from (11) to a sufficient degree of approximation

$$\frac{1}{\gamma} = 1 + \frac{1}{2} \frac{e^2 E^2}{p^2 c^2}, \quad \Delta\phi = 2\pi \left(\frac{1}{\gamma} - 1 \right) = \frac{\pi e^2 E^2}{p^2 c^2}.$$

From this we wish to pass on to the motion of Mercury's perihelion which we touched on earlier, on page 468. For this purpose we write mM in place of eE , thereby supposing Newton's law to act instead of Coulomb's, and we take m as the mass of the planet, and M as that of the sun. Further, we express the momentum constant p of the planet in terms of the geometrical areal constant f thus:

$$p = 2mf, \quad f = \frac{\pi ab}{\tau} = \frac{\pi a^2 \sqrt{1 - \epsilon^2}}{\tau}$$

(τ is the time of revolution of the planet, πab the surface swept out in the time τ). Thus

$$\Delta\phi = \frac{\pi m^2 M^2}{p^2 c^2} = \frac{M^2 \tau^2}{4\pi a^4 (1 - \epsilon^2) c^2} \quad (12)$$

Finally we express the mass of the sun according to Kepler's third law, which is, as we know:

$$\frac{a^3}{\tau^2} = \frac{M}{4\pi^2}$$

From (12) we then get, in conjunction with the latter:

$$\Delta\phi = \frac{4\pi^3 a^2}{\tau^2 (1 - \epsilon^2) c^2} \quad (13)$$

If we insert in this the data of Mercury for a , τ , and ϵ , then we get the value $\Delta\phi = 7''$ per century, quoted on page 468. The general theory of relativity gives almost the same formula as (13) but with the numerical factor 24 instead of 4. Hence, according to general relativity, we get six times greater value $\Delta\phi = 43''$, also mentioned on page 468, which is in full agreement with the observed value as modified by Newcomb.

17. Quantising of the Non-harmonic Oscillator during Simultaneous Rotation *

Let us consider, for example, HCl; let the ions have the charges $+e$, $-e$, and the masses m_1 , m_2 . Their centre of gravity remains at rest

* A. Kratzer, *Zeitschr. f. Phys.*, **3**, 289 (1920).

and serves as the origin of a polar co-ordinate system: $r_1\phi_1$ and $r_2\phi_2$ are the co-ordinates of m_1 and m_2 . Using the theorem of centres of gravity we introduce in their place the new co-ordinates $r\phi$ of the point-mass by means of the equations:

$$\begin{aligned} m_1 r_1 &= m_2 r_2 = \mu r, \\ \phi_1 &= \phi_2 + \pi = \phi. \end{aligned}$$

Here, as on page 220, μ denotes the "reduced mass" of both ions and r the distance between them:

$$\frac{1}{\mu} = \frac{1}{m_1} + \frac{1}{m_2}, \quad r = r_1 + r_2.$$

The kinetic energy is easily expressed in the co-ordinates r, ϕ :

$$E_{kin} = \frac{m_1}{2}(\dot{r}_1^2 + r_1^2\dot{\phi}_1^2) + \frac{m_2}{2}(\dot{r}_2^2 + r_2^2\dot{\phi}_2^2) = \frac{\mu}{2}(\dot{r}^2 + r^2\dot{\phi}^2). \quad (1)$$

The potential energy is expressed electrostatically and depends only on $r = r_1 + r_2$:

$$E_{pot} = -\frac{e^2}{r} \left(1 + \frac{c_1}{r} + \frac{c_2}{r^2} + \frac{c_3}{r^3} + \dots \right). \quad (2)$$

The coefficients c_1 express the action of the electronic systems surrounding the ions and are to be regarded as arbitrary quantities, between which the following condition of equilibrium exists:

$$\frac{d}{dr} E_{pot} = 0, \quad \text{for } r = r_0. \quad (3)$$

Here r_0 denotes the normal distance between the two ions for a molecule at rest in space, at which the electrostatic attractions and repulsions between nuclei and electrons remain in equilibrium. Let us set

$$\rho = \frac{r}{r_0}, \quad \xi = \rho - 1. \quad (4)$$

Instead of (2) let us write

$$E_{pot} = -a \left(a + \frac{1}{\rho} + \frac{1}{2\rho^2} + b\xi^3 + c\xi^4 + \dots \right). \quad (5)$$

This assumption already satisfies condition (3) and is just as general as (2). It has the advantage over (2) that the correction members with the coefficients b, c, \dots are small in the neighbourhood of the position of equilibrium and that the "principal members" preceding them can be taken accurately into account in the quantising later. The fact that the expansion in ξ 's in eqn. (5) begins with ξ^3 and not with ξ^2 nor with ξ is shown if we pass on to the mutual force acting on the ions. It is

$$\begin{aligned} \mathbf{K} &= -\frac{d}{dr} E_{pot} = -\frac{1}{r_0} \frac{d}{d\rho} E_{pot} \\ &= -\frac{a}{r_0} \left(\frac{1}{\rho^2} - \frac{1}{\rho^3} - 3b\xi^2 - 4c\xi^3 + \dots \right) \end{aligned}$$

or, on account of (4)

$$\mathbf{K} = -\frac{a}{r_0} \left(\frac{\xi}{\rho^3} - 3b\xi^2 + 4c\xi^3 + \dots \right). \quad (6)$$

where we may, further, replace ρ^3 in the denominator by $(1 + \xi)^3$. Since all powers of ξ are represented here and are furnished with arbitrary coefficients, we have, indeed, by using our assumption (5), arrived at the law of force of the most general non-harmonic oscillator.

From the first member of the expansion (6) we deduce the vibration number ν_0 for an infinitely small amplitude, namely,

$$2\pi\nu_0 = \sqrt{\frac{a}{r_0^2\mu}} \quad \dots \quad (7)$$

If we define

$$J = (m_1r_1^2 + m_2r_2^2)_0 = \mu r_0^2 \quad \dots \quad (8)$$

as the moment of inertia of the molecules in the state of equilibrium, we may also write eqn. (7) thus :

$$2\pi\nu_0 = \sqrt{\frac{a}{J}}, \quad a = 4\pi^2\nu_0^2J \quad \dots \quad (9)$$

On account of (4) and (8), (1) becomes

$$E_{kin} = \frac{J}{2}(\dot{\rho}^2 + \rho^2\dot{\phi}^2) \quad \dots \quad (10)$$

From this it follows that

$$p_\rho = \frac{\partial E_{kin}}{\partial \dot{\rho}} = J\dot{\rho}, \quad p_\phi = p = \frac{\partial E_{kin}}{\partial \dot{\phi}} = J\rho^2\dot{\phi}.$$

p is constant and is equal to $nh/2\pi$ on account of the *azimuthal quantum condition*. The energy equation is :

$$\frac{1}{2J} \left(p_\rho^2 + \frac{p^2}{\rho^2} \right) + E_{pot} = W \quad \dots \quad (11)$$

It follows from this that

$$p_\rho = \sqrt{2JW - 2JE_{pot} - \frac{p^2}{\rho^2}}$$

and the *radial quantum condition* is :

$$\oint p_\rho \, d\rho = \oint \sqrt{2J(W + a\alpha) + \frac{2Ja}{\rho} - \frac{1}{\rho^2}(aJ + p^2) + \dots} \, d\rho = nh \quad \dots \quad (12)$$

The terms as far as they are written down under the root sign have the following form, familiar to us from eqns. (8) and (10) in Note 6 :

$$\oint \sqrt{A + \frac{B}{\rho} + \frac{C}{\rho^2}} \, d\rho = -2\pi i \left(\sqrt{C} - \sqrt{A} \right)$$

and, indeed, if we divide (12) throughout by \sqrt{aJ} , the coefficients A, B, C , have the significance

$$A = 2 \left(\alpha + \frac{W}{a} \right), \quad B = 1, \quad C = - \left(1 + \frac{p^2}{aJ} \right) = - \left(1 + \frac{m^2h^2}{4\pi^2aJ} \right) \quad (13)$$

Consequently (12) becomes

$$\frac{nh}{\sqrt{aJ}} = -2\pi \left(\sqrt{1 + \frac{m^2 h^2}{4\pi^2 aJ}} - \frac{i}{\sqrt{A}} \right) + Z \quad (14)$$

Here, by (12), (5), and (4), the supplementary term Z denotes

$$Z = \oint \sqrt{C_1 + 2B_1\xi + A_1\xi^2} d\xi - \frac{1}{2} \oint (b\xi^3 + \dots)^2 (\xi + 1)^3 (C_1 + 2B_1\xi + A_1\xi^2)^{\frac{1}{2}} d\xi \quad (15)$$

in which we have set

$$A_1 = A, \quad B_1 = B + A, \quad C_1 = C + 2B + A \quad (16)$$

The integrals that occur in (15) have the form of K_n and K'_n on pages 554 and 555. We may therefore write (15):

$$Z = bK_2 + (b+c)K_3 + \dots - \frac{1}{2}b^2K'_3 + \dots \quad (17)$$

If as in eqn. (7) on page 418 we take $\Delta\nu$ to stand for the distance between neighbouring band-lines $\Delta\nu = h/4\pi^2J$, and ν_0 , as in eqn. (9) on page 613, to stand for the mutual vibration number $\nu_0 = \sqrt{a}/2\pi\sqrt{J}$, then

$$u = \frac{\Delta\nu}{\nu_0} = \frac{h}{2\pi\sqrt{aJ}} \quad (18)$$

must under any circumstances be a small quantity, of which we may in general neglect all powers beyond the second. Later we shall show that the ratios B_1/A_1 , C_1/A_1 are of the first order in u . We shall use this result at once here in calculating the K_i 's and K'_i 's. From eqns. (27) and (29) on pages 563 and 564 it then follows that

$$\left. \begin{aligned} K_2 &= -\frac{3\pi i}{\sqrt{A_1}} \frac{B_1 C_1}{A_1}, & K_3 &= -\frac{3\pi i}{4\sqrt{A_1}} \left(\frac{C_1}{A_1}\right)^2, & K_4 &= K_5 = \dots = 0 \\ K_3 &= -\frac{15\pi i}{4A_1\sqrt{A_1}} \left(\frac{C_1}{A_1}\right)^2, & K_1 &= K'_3 = \dots = 0 \end{aligned} \right\} \quad (19)$$

Thus the terms we omitted to write out in (17) may all be neglected in our approximation.

We next wish to resolve the quantum condition (14). If we divide both sides by -2π , then we get on the left $-nu$, and the first term on the right becomes $\sqrt{1 + m^2 u^2}$. For the second term i/\sqrt{A} which, by (13), contains the energy and hence may be selected as the term that is of interest to us, we write y :

$$y^2 = \frac{1}{A} = -2(a + W/a), \quad y = \frac{i}{\sqrt{A}} \quad (20)$$

(14) then becomes

$$-nu = \sqrt{1 + m^2 u^2} - y - \frac{Z}{2\pi} \quad (21)$$

By (17) and (19) the quantities B_1/A_1 and C_1/A_1 occur in Z . By (16), (13), and (20) these become :

$$\begin{aligned} \frac{B_1}{A_1} &= 1 + \frac{B}{A} = 1 - y^2 \\ \frac{C_1}{A_1} &= 1 + \frac{2B}{A} + \frac{C}{A} = 1 - 2y^2 + (1 + m^2u^2)y^2 = 1 - y^2 + m^2u^2y^2 \end{aligned} \tag{22}$$

If as a first approximation we set $u = 0$, eqn. (21) is satisfied by $y = 1$, since B_1/A_1 , C_1/A_1 , and also Z vanish for $y = 1$. Thus as our first approximation we have $y = y_1 = 1$. By setting as a second approximation $y = y_2 = 1 + \rho u$, we conclude from (22) that B_1/A_1 and C_1/A_1 vanish in the first order with u ; this fact we have already used above in calculating the values (19). By (19) Z then vanishes in u to the second order. From (21) we then get

$$\rho = n, \quad y_2 = 1 + nu$$

and from (22)

$$B_1/A_1 = C_1/A_1 = -2nu.$$

By proceeding step by step we get the following successive approximate values from (21) :

$$\begin{aligned} y_1 &= 1 \\ y_2 &= 1 + nu \\ y_3 &= 1 + nu + u^2 \left\{ \frac{m^2}{2} - n^2 \left(\frac{15}{2}b + \frac{3}{2}c - \frac{15}{4}b^2 \right) \right\} \\ y_4 &= 1 + nu + u^2 \left\{ \frac{m^2}{2} - n^2 \left(\frac{15}{2}b + \frac{3}{2}c - \frac{15}{4}b^2 \right) \right\} - 3n^3nm^2b. \end{aligned}$$

The last approximation does not seem quite logical in that here a term with u^3 has been taken into consideration whereas we have usually stopped at the terms with u^2 . The reason is as follows: u is, indeed, a small quantity, but in the case of fully developed bands m may in given cases assume great values, so that n^3m^2 is not to be neglected. We obtain the last term of y_4 , by setting $y = y_3$ in (22), that is, by setting

$$\frac{B_1}{A_1} = -2nu - m^2u^2 + \dots, \quad \frac{C_1}{A_1} = -2nu + \dots$$

so that in the expression (19) of K_2 we get

$$\frac{B_1}{A_1} \frac{C_1}{A_1} = 4n^2u^2 + 2nm^2u^3.$$

It is not difficult to show that even when higher powers are taken into account the added member is the only one in u^3 with the factor nm^2 .

To arrive at the energy expression W , we form, in accordance with (20) :

$$\left. \begin{aligned} -\frac{1}{2}y_4^{-2} &= a + \frac{W}{a} = -\frac{1}{2} + nu \\ + u^2 \left\{ \frac{m^2}{2} - n^2 \left(\frac{3}{2} + \frac{15}{2}b + \frac{3}{2}c - \frac{15}{4}b^2 \right) \right\} - \frac{3}{2}u^3nm^2(1 + 2b) + \dots \end{aligned} \right\} \tag{23}$$

By (18) and (9) we have

$$au = \frac{h}{2\pi} \sqrt{\frac{a}{j}} = h\nu_0, \quad av^2 = h\nu_0 u = h\Delta\nu = \frac{h^2}{4\pi^2 j}.$$

Thus we get from (23), except for a constant quantity, that is, one that is independent of n and m :

$$W = nh\nu_0 + \left. \begin{aligned} & \frac{h^2}{8\pi^2 j} m^2 - h\nu_0 u n^2 \left(\frac{3}{2} + \frac{15}{2} b + \frac{3}{2} c - \frac{15}{4} b^2 \right) \\ & - \frac{3}{2} h\nu_0 u^2 n m^2 (1 + 2b) + \dots \end{aligned} \right\} \quad (24)$$

If we set $m = 0$ in this, we get the pure *energy of oscillation*, which was called W_0^n in eqn. (10) on page 422, namely

$$W_0^n = nh\nu_0 (1 - xn + \dots) \quad (25)$$

From (24) we now get the following significance for the abbreviation x introduced earlier:

$$x = \left(\frac{3}{2} + \frac{15}{2} b + \frac{3}{2} c - \frac{15}{4} b^2 \right) u.$$

The pure *energy of rotation* is represented by the second member on the right-hand side of (24). It has the form of the Deslandres term. Finally the last term in (24) represents the term expressing *the mutual action between rotation and oscillation*. If, as in eqn. (11) on page 422, we write it as $-m^2 a_n h$, a_n acquires the meaning

$$a_n = \frac{3}{2} h\nu_0 u^2 (1 + 2b + \dots);$$

as emphasised on page 422, a_n is proportional to the oscillation quantum u .

In this note we have furnished all the necessary addenda for the detailed explanation of band-spectra.

INDEX

A

Ablängen, 262.
Abtrennungsarbeit = work of dissociation, 357.
 Abraham, 21, 249, 259.
 — moment of momentum of light, 572.
 — spherical waves, 532.
 — variability of mass, 528.
 Absorption, 448.
 — coefficient, 177, 188.
 — (of scattering), 31.
 — limits, 177.
 — as excitation limits, 181.
 — lines, 325.
 Acceleration, 194.
 Accumulation, time of, 41.
 Actinium group, 46.
 Action, at a distance, 1.
 — between rotation and oscillation, 436, 616.
 — function of, 556.
 — — — modified, 566.
 — quantum of, 37, 146, 193, 309, 555.
 Activity, 49.
 — addition relations, 523.
 — theorem of velocities, 459.
 Adiabatic hypothesis of Ehrenfest, 246, 304.
 — invariance of phase integrals, 594 *et seq.*
 — invariants, 305, 307.
 d'Alembert's principle, 542, 607.
 Alkalies, series systems of, 375.
 Alkaline earths, potentials of, 348.
 — — series systems of, 375.
 Angström unit, 41, 151.
 Angular co-ordinates, 566.
Anregungsspannungen, 342. *See* Excitation potentials.
 Anti-cathode, 23.
 α -particles, 16, 70.
 α' -particles, 90.
 α -ray, 15, 70.
 — deflections, 62, 65, 232.
 α -transformations, 46, 80.
 Arc spectra, 481.
 — — and spark spectra, related, 378.
 Areal constant, 233.
 — — (determines size of ellipse), 235.
 Aronberg, 102.
 Aston, isotopes, 86.
 Atom, doublet-, 406.
 — momentum of, 257.
 — planetary system of, 65.

Atomicity, 3.
 Atomic field, inner, 238.
 — models, 66, 200, 349, 601.
 — numbers, 56-59, 149.
 — size of hydrogen, 213.
 — volume, 98, 106.
 — weight, 56, 57.
Aufelektron. *See* Initial electron.
 Avogadro's number, 4, 139, 535, 603.
 Axes, unique, of intensity, 256.
 — — — polarisation, 266.
 Azimuth, orbital, 243.
 Azimuthal co-ordinate, 233.
 — quantum condition, 234.
 — — changes only by unity, 330.
 — — number, 243, 258, 325, 326, 332, 520.

B

Bachem, Zeeman effect of cyanogen bands, 446.
 Back, 382, 387, 404.
 Bahr, E. von, infra-red absorption spectra, 418.
 Balmer, 203, 316, 329.
 — formula, 204, 230.
 — resolution of Balmer lines, 285.
 — series, 157, 200, 216, 218, 487, 580.
 — — (Bohr's theory), 211.
 — — (in relativity), 473.
 — — (possibilities of production), 239, 336.
 — term, 597.
 Band, double, 420.
 — edge of, 433.
 — ground, 423.
 — group, 433.
 — lines, law of, 209.
 — overtone, 423.
 — spectra, 202, 209, 413.
 — system, 433 *et seq.*
 Barkla, 23, 29, 141 *et seq.*, 147.
 — fluorescent radiation, 179.
 — and Sadler, coefficient of mass absorption, 23.
 Bauer and Piccard, 251.
 Benoist, hardness gauge, 192.
 Bergmann series, 315, 379.
 Berzelius, 104.
Besetzungszahlen (= distribution numbers), 109, 230.
 Birge, hydrogen doublet, 497.
 — fine structure constant, 528.

- Bismuth, used for Röntgen photographs, 191.
- Bjerrum, rotation spectra, 413, 419.
- Black body radiation, 36.
- Blake and Duane, determination of h from excitation potential, 178.
- Bode, Titius, 67.
- Bohr, 43, 59, 78, 79, 96, 109, 218, 221, 242, 313, 339, 351, 393, 418, 421, 439, 444, 447, 449, 477, 505, 523, 547, 586, 605.
- absorption equation, 43.
 - circular orbits, 66, 72, 212, 270.
 - correspondence, principle of, 254, 270, 274, 275, 368, 483, 572 *et seq.*
 - emission equation, 44.
 - frequency condition, 216, 228, 266, 304, 473.
 - magneton, 249, 407.
 - model of hydrogen atom, 200, 349.
 - principle of mechanical transformability, 304.
 - theory of Balmer's series, 211.
- Boisbaudran, de, 59.
- Boltzmann, 307.
- constant, 439.
- Born, crystal calculations, 104.
- Bourget, 70.
- Bragg, Sir W., crystal structure, 110, 122, 131, 137.
- W. L., 122, 131, 137.
 - and Peirce, absorption coefficient, 190.
- Bravais, 117, 124.
- Bremsstrahlung* = impulse spectrum, 25, 450.
- β -activity, 55.
- β -rays, 15, 19.
- β -transformations, 46, 81.
- Brinsmade and Kemble, overtone bands, 424.
- Brock, van den, atomic number and nuclear charge, 66, 89.
- Broglie, de, velocity spectrum, 131, 449, 514.
- Bromine band, 136.
- Buisson, 70.
- Burgers, adiabatic hypothesis, 304.
- energy, 594.
 - - group of ellipses, 547.
- Burgess, 503.
- Burneister, infra-red absorption, 419.
- Charlier, celestial mechanics, 561.
- Chlorine isotopes, 102, 425.
- Circular orbits, 270.
- polarisation, 66, 72, 212, 270.
- Coefficient of extinction, 536.
- Coherence length, 362.
- Colour photography, 130.
- Combination defects, 355, 433, 523 *et seq.*
- principle of, 202, 389.
 - inexact, 332.
- Complex variables, 548, 549, 562.
- Composite doublets, 166.
- triplets, 360.
- Compressibility, 500.
- Conditionally periodic motions, 201, 307, 559, 561, 567, 577.
- Conservation of energy, 257.
- — moment of momentum, 257.
- Constancy of frequency differences, 362.
- — the velocity of light, 455.
- Contact potential, 38.
- transformations, 545, 547, 566.
- Continuous spectrum, 447.
- Continuum approximation, 580.
- Convection coefficient, 453.
- Coolidge tube, 152.
- Co-ordinates, choice of, 201.
- "force-free," 565.
 - cyclic, 443.
- Copernicus, 460.
- Coriolis forces, 296.
- Correspondence, principle of, 254, 270, 368, 483, 572 *et seq.*
- Coster, 161, 172.
- M-lines, 186.
 - Röntgen spectra, 515, 522.
- Coulomb, 4, 75.
- law of attraction, 65, 77, 211.
- Cross law (= law of exchange, *Wechselsatz*), 372, 386.
- Croze, many lines spectrum of H, 209, 440.
- Crystal analysis, 121, 537.
- atoms, 121.
 - constant, 138.
 - powder method, 136.
 - structures tabulated, 537 *et seq.*
- Curie, 59.
- constant, 249.
- Curly, 572.
- Cyanogen band, 429.
- Cyclic co-ordinates, 443.

C

- Cabrera, 247.
- Canal rays, 8, 13, 86.
- Canonical conjugates, 546.
- variables, 545.
- Cathode ray electrons, 8.
- - tubes, 2.
 - rays, 8, 13.
 - secondary, 23.
- Chadwick, deflection of α -rays, 63.
- Chaucourtois, 61.
- Charge, electric, 23.

D

- Darwin, 61, 476.
- Dauvillier, 164, 515.
- Davies and Goucher, direct and photo-electric ionisation, 339.
- - - excitation of Hg-lines, 346, 347.
- Debye, 44, 78, 304.
- interference phenomena, 536.
 - $K\alpha$ -emission, 226.
 - and Scherrer, crystal powder method, 122, 136, 137.

- Defective combinations, 187.
 Degenerate problems, 200, 241, 246, 284, 564, 567, 571.
 Degrees of freedom, 200.
 Dember, Loschmidt's number, 535.
 Dempster, isotopes of magnesium, 87.
 Deslandres, law of band lines, 209, 413, 417, 434.
 Determining factors of spherical wave, 255, 572 *et seq.*
 Diatomic molecules, 416.
 Diffraction, 110, 111, 253.
 — centres of, 115.
 — of Röntgen rays, 118, 119.
 Dissociation potential, 243, 603.
 — work of, 603.
 Displacement laws of radioactivity, 81.
 — spectroscopic law of, 372.
 Distribution numbers (Besetzungszahlen), 109, 230. *See also* Strengths of shells.
 Doppler's principle, 34, 460.
 Dorn, secondary cathode rays, 23.
 Dot notation, Newton's, 24.
 Double bands, 420.
 Doublet atoms, 406.
 Doublets, 151, 370, 375, 381.
 — associated, 173.
 — composite, 166.
 — equal intervals of, 161, 507.
 — improper, 382.
 — intermediate, 505.
 — irregular, 506-512, 519, 521.
 — M-doublets, 506.
 — proper and improper, 382.
 — of radium, 377.
 — regular and irregular, of Röntgen spectra, 496 *et seq.*
 — regular, 505, 519, 521.
 — relationships, 159.
 — systems, 365, 378, 391.
 Duane, Röntgen spectra, 133, 187.
 — and Hunt, 178.
 — — Kang-Fuh Hu, 152, 185.
 — — Patterson, 184, 186.
 — — Stenström, 152, 184, 185, 523.
 — — Stenstrom, and Fricke, 185.
 Dulong and Petit's law, 101.
 Dunz, series terms, 205.
 Dynamide, 13.
 — theory, 62.
- E**
- e, 525. *See* Spectroscopic units.
 Eder and Valenta, 374, 449.
 Effective nuclear charge, 68, 73.
 Ehrenfest's adiabatic hypothesis, 216, 304.
Eigenstrahlung, 25.
 Eight shell (8-shell), 103, 302, 449, 503.
 Einstein, 21, 95.
 — addition theorem of velocities, 459.
 — inertia of energy, 95.
 — light quanta, 38, 254.
 — photo-electric equation, 38, 42, 253.
 Einstein, relativity, 452, 466, 468.
 — time-dilatation of, 460.
 Electricity, 22.
 Electrochemical equivalent, 4, 221, 526.
 Electrodynamics, 1-3.
 Electrolysis, law of, 3.
 Electromagnetic waves, 24.
 Electromagnetism, 1-3.
 Electron, 5, 6, 7.
 — affinity (hunger), 103, 449.
 — impact of, 377 *et seq.*
 — mass of, 5, 20, 22, 528.
 — negative and positive, 22.
 — shells, 72.
 — quasi-elastically bound, 196.
 — transitions of, 144, 145.
 Electronegative, 103.
 Electropositive, 103.
 Elements, table of, 57.
 — undiscovered, 59.
Ellipsenverein = group of ellipses, 230.
 Elliptic orbits, hydrogen, 233.
 — energy of, 236.
 — quantised, 236.
 Ellis, photo-electric effect and energy levels, 449.
 Elster and Geitel, photo-electric effect, 35.
 Emission, 144, 270, 416.
 — spectrum, 447, 450.
 Energetics, 3.
 Energy, changes in atom, 214.
 — field, 547.
 — flux, 532.
 — inertia of, 452, 464.
 — potential and kinetic, in Coulomb field, 75.
 — quanta, 37, 200.
 — of rotation, 616.
 — steps (*niveaux*), 146.
 Epstein, 444, 594.
 — choice of co-ordinates, 562.
 Equatorial axes, 442.
 — quantum number, 213, 271, 300.
 Ether, 215, 257, 258, 263, 454.
 — absolute theory of, 529.
 — momentum of, 259.
 Eucken, distances between infra-red band lines, 423.
 Eulerian angles, 443.
 Excitation limits, 140, 177, 180.
 Exner and Haschek, 378.
- F**
- Fabry, 70.
 — and Buisson, 209, 482.
 Fajans, 45, 88, 108.
 — displacement laws of radioactivity, 81.
 Faraday, 1, 3.
 Fedorow, 117.
 Field, theory, 1.
 — weak, 400.
 Fine structure, 213, 237, 474 *et seq.*
 — constant, 525, 531.
 First subsidiary series of H, 207.

- Fizeau, 453.
 Flamm, 215, 224.
 — semi-spectroscopic units, 527.
 Flutings (*Kannelierungen*), 202.
 Foote, Meggers, and Mohler, 333, 348.
 — and Mohler, 341, 348, 354.
 — Mohler, and Simson, 348, 349.
 — Rognley, and Mohler, 345.
 Fortrat, band formula, 426.
 — null line of band spectra, 429.
 Fourier's integral, 29, 449, 568, 595.
 Fowler, 207, 373, 376, 440.
 — series, 207, 317.
 Franck, 218.
 — and Eiusporn, 348.
 — — Hertz, 337, 347.
 — — Knipping, 344.
 — — Reiche, 350.
 — — Steubing, 449.
 Fraunhofer lines, 203, 380.
 Frequency differences, 496.
 — condition of Bohr, 215, 228, 254, 266, 304.
 — proper and improper, 217.
 Fresnel, 253.
 Fricke, 184, 185.
 — K-limits, 189.
 Friedrich, 118, 134.
 — coherence of scattered radiation, 536.
 Friman, L-series, 159, 161.
 Fuchtbauer, optical excitation, 351.
 — and Hofmann, 365.
 Fues, 318, 376.
 Fundamental series, 315.
- G**
- Gehrcke and Lau, 209, 482.
 — — Seeliger, 338.
 Geiger, deflection of α -rays, 62.
 Gerlach, 337.
 Gibbs, phase space, 195.
 Glocker, formula for absorption coefficients, 188, 190.
 Goethe, 3.
 Goldstein, canal rays, 14, 374, 440.
 Gotze, 368.
 Graulmol, 4.
 Grating crossed, 113.
 γ -rays, 23.
 — connection with β -rays, 43.
 Grebe and Holtz, bands of water-vapour, 431.
 Grimm, curve of ionic volumes, 107, 108.
 Grossmann, motion of Mercury's perihelion, 468.
 Grotrian, Bohr diagram, 351.
 — neon spectrum, 383.
 Ground band, 423.
 — orbit, 284, 321.
 — spectra, 374.
Grundbahn. See Ground or natural orbit.
 Guye and Lavanchy, proof of relationistic change of mass, 464.
 Gypsum, lattice constant, 153.
 Gyroscopic motion, 441, 587.
- h**, 97, 146, 193, 198, 202, 217, 252, 307, 525, 555.
 Haas, Rydberg's number, 216.
 Half-value time, 46.
 Hahn, 48, 84.
 Hallwachs, photo-electric effect, 35.
 Hamilton's canonical equations, 194, 280, 466.
 — — — invariability of, 541.
 — function H, 194, 589, 607.
 — — — modified, 546.
 — partial differential equations, 555, 558.
 — theory in relativity, 606 *et seq.*
 Hardness gauge, 192.
 — relative, 147.
 — Röntgen light, 28.
 Hard rays, 536.
 Harkins, 61, 96.
 Harkins and Aronberg, spectra of lead isotopes, 102.
 Hartmann, continuous emission spectrum of H, 447.
 Haury, 117.
 Heat of combination, 95.
 Heisenberg, 405, 412.
 Helium atom (ionised), 69.
 — ion (neutral), 68.
 — lines compared with Balmer series, 223.
 — model of nucleus, 96, 231.
 Heinholtz, 3, 454.
 — kinetic potential, 606.
 Hertz, G., 172, 186.
 — law of irregular doublets, 509, 511, 512, 524.
 — L-limits, 189.
 Hertz, Heinrich, 1, 2, 35, 243, 276.
 Herzfeld, 108.
 Heteropolar dipole, 583.
 Hettner, overtone bands, 424.
 Heurlinger, band spectra, 413, 430, 431, 435, 416.
 — criterion of intensity, 428.
 Hewlett, 188.
 — total coefficient of extinction, 536.
 Hexadecade of elements, 58.
 H-ion, 7, 68.
 Hjalmar, precision measurements of L-series, 152, 160, 161.
 — screen number, 507.
 — weak K-lines, 525.
 H-rays, 92.
 H-transformations, 88.
 Hittorf, 8.
 t'Hoff, van, 125.
 Holtzmark, 447, 448.
 — absorption spectrum of Na, 203.
 Homocopolar molecule, 425.
 Hönigschmid, 80.
 Horton, ionisation steps of He, 344.

- Hoyt, excitation limits of the L-series, 154, 180, 181.
 Hull, crystal powder method, 136.
 Hydrogen, atom, 68, 473.
 — ion, 7, 68.
 — mass, true and imagined, 139, 221.
 — spectra of the type of (*wasserstoffähnlich*), 209.
 — spectrum, 202 *et seq.*
- I**
- Ines, absorption spectra of halogen acids, 419, 420.
 Impulse (*see* Momentum), 195.
 — spectrum (*Bremsstrahlung*), 25, 450.
 Inert gases, 103.
 Inexact combinations (Fowler), 332.
 Infra-red absorption spectra, 416.
 Initial or migratory electron (*Aufelektron*), 325, 329, 596.
 Integration by complex variables, 548.
 Intensities, 273, 487, 491, 583, 586.
 — rule of, 369, 490.
 — statistical, 583.
 Interference, 253.
 — of Rontgen rays, 115, 116.
 — photographs, 118, 119.
 Intra-atomic magnetic field, 363.
 Invariable plane, 251, 264, 269.
 Ion, 3, 68.
 Ionic sizes, curve of, 107.
 — volume, 106.
 Ionisation and photo-electric effect, 339.
 — method of X-ray spectroscopy, 135.
 — potentials, 69, 341.
 — — of Bohr's original models, 601 *et seq.*
 Ionised atoms, 372.
 Ishiwara, quantising of several degrees of freedom, 200.
 Isotopes, 84.
- J**
- Jacobi, 547, 568, 605.
 — elliptic co-ordinates, 279.
- K**
- Kannelierungen* = flutings, 440.
 Kaufmann, deflection of β -rays, 19, 34.
 — proof of variability of mass, 464.
 Kayser, 378.
 — and Runge, 380.
 K-doublets, 151, 161.
 — and L-doublets, difference in, 170.
 K-excitation, 504.
 Kent, doublet of Li, 361.
 — Paschen-Back effect, 401.
 Kepler laws, 212, 233, 529.
 — motions, 212, 303.
 — — relativistic, 466 *et seq.*
 Kinetic potential, 606.
 Kirchhoff, 421.
- Knipping, electron affinity of halogens, 118, 449.
Knotenlinie, 243.
 Koch, P. P., photometry, 111.
 Kohlbrausch, extinction coefficient, 536.
 Konen, 334.
 Kossel, 104, 143, 354.
 — addition relations, 523.
 — explanation of successive maxima of K-limits, 190.
 — and Sommerfeld, 373, 378.
 K-radiation, 142.
 Kramers, intensity of spectral lines, 275, 487, 491, 583, 586.
 Kratzer, 285, 291.
 — band spectra, 413, 422, 424, 434, 611.
 K-ring, 143, 227.
 Kroo, *Besetzungszahlen*, 229.
 K-series, 137, 140.
 — absorption limits, 185.
 — Ag-leaf, 182.
 — ν/R -values, 156, 157.
 — wave-lengths, 153.
 K-shell, 143.
- L**
- Ladenburg, 109, 383.
 — useful formula, 340.
 Lagrange, 547.
 — function, 513, 607.
 Landé, crystal calculations, 101, 367, 383, 393, 399, 400, 407, 503.
 Langevin, paramagnetism, 247, 250.
 Langmuir, work of dissociation of hydrogen, 603.
 Larmor, precession of orbits, 296, 301, 309, 310.
 latitude, 243.
 Lattice, 113, 537.
 — constants, 117, 120, 140, 152.
 — points, 115.
 — pseudo-graphite, 127.
 — space-centred, 123. *See also* Crystal structure.
 Laue, 3.
 — diffraction of Röntgen rays, 110, 118.
 Law of rational indices, 128.
 L-doublets, 160, 161, 496.
 — table of, 162, 163, 500.
 L-levels, 502 *et seq.*
 Le Bel, 125.
 Legendre transformations, 546.
 Lenard, 2, 8, 12, 13, 35, 62, 338. *See* Dynamide theory.
 Lenard window, 12.
 Lenz, 413, 430, 431, 445, 446, 528.
 — model of He-nucleus, 96, 231.
 Levels, scheme of, 322, 519. *See* L-, M-, N-, O-, P-levels.
 Libration limits, 282, 561.
 — periods, 450.
 Liebert, combination series in the electric field, 332.

- Light quanta, 44, 254.
 Line-element, 588.
 Linear oscillator, 195.
 — polarisation, 261.
 Line intervals, 287.
 — Mercury lines, 352.
 — spectra, 202.
 Lippmann, colour photography,
 Lissajous curves, 561, 581.
 Lithium atom, 71.
 — fluoride, 137.
 Löbe, intensity differences of Röntgen rays,
 34.
 Lohmann, Zeeman effect of neon-lines,
 383, 390.
 Lohuizen, van, anomalous Zeeman effect
 and principle of combination, 390.
 Longitudinal vibrations, 23.
 Loomis, band-spectra and isotopes of
 chlorine, 424.
 Lorentz, term representation of arc spectra,
 375.
 Lorentz, 2, 21, 95, 259, 400.
 — contraction, 458, 461.
 — displacement, 296.
 — theory of Zeeman effect, 295, 304.
 — transformation, 457, 532.
 Loschmidt's (or Avogadro's) number, 4,
 139, 535, 603.
 Lo Surdo, Stark effect, 277.
 L-radiation, 142, 141.
 L-ring, 143, 227.
 L-series, 140, 354.
 — absorption limits, 186.
 — Ag-leaf, 183.
 — $\sqrt{\nu/R}$ values, 166, 167.
 — excitation limits, 181.
 L-shell, 143.
 L-terms, 497.
 Lunelund, Stark effect of H-canal rays, 313.
 Lyman, 378, 480, 487.
 — ultra-violet series of H, 207, 218.
 — — — — He, 224, 226.
 — and Fricke, ultra-violet lines of helium,
 350.
- M**
- Mach, 3.
 McLennan and Henderson,
 Magnetic axis, 408.
 — quantum number, 392, 407.
 — spectrum = velocity spectrum, 43, 449.
 Magnetron, 247 *et seq.*
 — Bohr, 249, 407.
 — Weiss, 251.
 Magneto-optic law of resolution (Sommer
 field's), 390.
 Malmer, 152.
 Mandersloot, overtone bands, 423.
 Many-lines spectrum (*Viellinienspectrum*),
 209, 344, 414, 440.
 Marsden, 62.
 Mass, variability of, 452, 461, 528.
 Mass, reduced or resultant, 220, 240, 425,
 612.
 Maxwell, 1, 2.
 — equations, 254.
 Maxwell-Boltzmann law, 420.
 M-doublers, 160, 506.
Mehrlinienspectrum (more-lines spectrum),
 345.
 Meissner, composite doublets in the Berg-
 mann series of Cs, 359, 362.
 — neon spectrum, 382.
 — and Paschen, hydrogen doublet, 482.
 Meitner, structure of nuclei, 84, 90.
 Mendeleef, periodic classification, 56, 98.
 Mercury lines, 352.
 Mercury's perihelion, 468, 611.
 Merton, differences in the spectra of isotopes
 of Pb, 102.
 Meta-neon, 86.
 Meta-stable states, 79, 350.
 Meyer, Edgar, directional character of γ -
 emission, 34.
 — Lothar, atomic volumes, 56, 61, 106.
 — Stefan, atomic volumes, 46, 99.
 Michelson, 482.
 — and Morley's experiment, 454.
 Miller, anomalous Zeeman effect, 388.
 Millikan, electron, 15, 39, 527.
 — extension of ultra-violet region, 161.
 — reversing potential, 41.
 — spectra, 207.
 Minkowski, four-dimensional world, 457.
 Modified function, 546.
 Moduli of periodicity, 555, 559.
 Mol, 4.
 Molecule, hydrogen, 438.
 — diatomic, 441, 413.
 Molecular size, 430.
 Moment of inertia of molecule, 415.
 — — — — models, 72.
 Momentum, 194, 257, 469.
 — co-ordinates, 233.
 — moment of, 199, 257, 258, 572.
 Monochromatic vibrations, 216, 269.
 Moore, anomalous Zeeman effect, 388.
 More-lines spectrum, 345.
 Moseley, 135, 140, 149, 161, 509.
 — high frequency spectra, 147, 149.
 — law of, 176.
 — nomenclature, 159, 177.
 Moving systems, 455.
 M-radiation, 142.
 M-ring, 143.
 M-series, 140.
 — wave-lengths, 172.
 — ν/R -values, 174.
 M-shell, 143, 507.
- N**
- Natural orbits (*Grundbahnen*), 284, 324.
 N-doublers, 160.
 Nernst and Eucken, specific heat of rota-
 tion, 439.

Index

- Net planes, 130, 138.
 Newcomb, 168, 611.
 Newlands, 56.
 Newton, J.
 -- gravitational law, 65.
 -- laws of motion, 193, 257, 452.
 Nicholson, group of ellipses, 502.
 -- quantum condition for rotator, 212.
 -- ring systems, 602.
 Niggli, 127.
 Nilson, 59.
Niveaux. See Levels.
 Normal levels, 516.
 N-shell, 507.
 Nuclear charge, 13, 64, 226.
 -- "effective," 69, 73, 498.
 -- defect, 503.
 -- physics, 89 *et seq.*
 -- theory of matter, 62.
 -- vibrations, 416, 433.
 Nucleus, 13, 55, 63.
 -- relative motion of, 218, 240.
 Null line (= zero line) of rotation bands,
 . 419, 445.
- ### O
- One-line spectrum, 345.
 Orbit, natural or ground, 281, 324.
 Orbital azimuth, 243.
 -- equation, 569.
 -- plane, 303.
 Order numbers (*Ordnungszahlen*), 578.
 -- of interference, 116.
Ordnungszahlen. See Order numbers.
 Oscillator, linear, 195.
 -- spatial, 195, 199, 560.
 O-shell, 512.
 Ostwald, 3.
 Overtone bands, 423.
- ### P
- Parabolic co-ordinates, 571, 588.
 -- quantum numbers, 283.
 Paramagnetic substances, 249, 413.
 Partial series, 319.
 Paschen, 318, 333, 346, 380, 383, 418, 420,
 483, 488, 490, 491, 527, 583.
 -- He-lines, 531.
 -- infra-red series, 206, 207, 218, 223, 457.
 Paschen-Back effect, 285, 381, 388, 401,
 409, 495.
 -- partial, 389, 409.
 Paschen and Back, 300, 363.
 Pauli, 79, 313, 605.
 -- theory of magneton, 249.
 Periodicity and non-periodicity, 567.
 -- conditional, 201, 307, 559, 561, 567, 577.
 -- of atomic structure, 102.
 Periodic table, 57, 99.
 Permanency of multiplicities, 358.
 Phase, 195.
 -- area, 195.
- Phase, integral, 198, 201.
 -- orbits, 198.
 -- points, 195.
 -- space, 195.
 Photo-electric effect, 35, 448.
 -- indirect, 339.
 -- laws of, 36.
 -- normal, 35.
 -- selective, 35.
 Pickering, spectra of nebular clusters, 207,
 208.
 -- series, 208, 222, 223, 317, 373, 493.
 Planck, 86, 200.
 -- oscillator, 193, 195, 196.
 -- rotator, 195, 199.
 Pleiads, 87.
 P-levels, 515.
 Pohl, 111.
 Poincaré, 259.
 Poinset motion, 442, 444.
 Point transformation, 541.
 Poisson, 517.
 Polarisation, 23, 289, 581,
 -- in Zeeman effect, 294,
 -- left circular and right circular, 265,
 272.
 -- linear, 273.
 -- of wave, 255, 261, 262.
 -- rule of, 264 *et seq.*, 273.
 Popow, 363, 378.
 Positive ion, 13.
 -- rays, 14, 86.
 Potential. See Dissociation.
 -- See Ionisation.
 -- See Resonance.
 Poynting's vector of energy-flux, 260.
 Precession, Larmor, 296, 297, 301, 309,
 441, 586.
 Preston's rule, 385, 388.
 Principal series, 207, 315.
 Probability, statistical, 263.
 -- of orbits, 247.
 Prout's hypothesis, 56, 59, 87.
 P-shell, 512.
 Ptolemy, 466.
- ### Q
- Q-series, 431.
 Quantised orbits, 198, 212, 236.
 Quantising of spatial position of orbits,
 243.
 -- of elliptic motion, 569.
 -- by separation of variables,
 608.
 Quantum of action, 37.
 -- ground, 520.
 -- numbers, 67, 243, 283, 357, 520.
 -- inner, 358, 364, 520.
 -- magnetic, 392, 409.
 -- orbits, 67, 236, 326.
 -- sum, 334.
 -- theory, 36 *et seq.*

R

- R** = Rydberg-Ritz constant.
 Radial quantum condition, 277.
 — number, 326.
 Radiation, 25, 112, 118.
 characteristic, 25, 28, 110, 137.
 homogeneous, 28, 112.
 — impulse, 25, 29, 110, 137, 179.
 — momentum of, 257.
 Radioactive constant, 49.
 — equilibrium, 41.
 — families, 46.
 — substances, 17.
 Radioactivity, 45.
 — decay, theory of, 53.
 — disintegration (table), 47.
 — displacement, laws of, 81.
 Radium, doublet, 377.
 — emanation, 53.
 Raleigh and Ramsay, 56.
 Ramsauer, linear law, 39.
 Rational units, 259.
 Rau, 339.
 Rawlinson, 42.
 Rayleigh, intensity of scattered light, 535.
 Reduced or resultant mass (*reduzierte masse*), 220, 240, 425, 612.
 Reflection of Röntgen rays, 130.
 Reiche, specific heat of rotation of H_2 , 421, 439.
 Relative motion of nucleus, 218, 219.
 Relativistic Kepler motion, 466 *et seq.*
 Relativity, 452 *et seq.*
 — correction, 158, 164, 203, 187.
 — Hamilton's theory in, 606.
 Resolution of series terms, 477 *et seq.*, 187.
 Resolving power of lattice, 113.
 Resonance line, 341.
 — potential, 341.
 Reversible processes, 305.
 Revolving crystals, method of, 131.
 Riemann surface, 551.
 Ritzmeyer, non-existence of J-radiation, 144.
 Ritz, 315, 329, 375, 600.
 — principle of combination, 205.
 Robinson, 42.
 Rock salt, Röntgen spectrum of, 137.
 Rojdestvensky, 329, 330, 332.
 Röntgen rays, 15, 23, 110, 111, 139, 353.
 — — photographs (medical), 191.
 — — primary, secondary, tertiary, 23.
 — — spectra, 512.
 — spectrum (white), 29.
 Rotating systems, 466.
 Rotation and oscillation, 436, 616.
 — number (*Umlaufszahl*), 275.
 — spectra, 416 *et seq.*
 — vibration spectra, 416 *et seq.*
 Rotationless molecule, 587.
 Rotator, 195, 199, 211, 443.
 — (magneton), 248.
 — of Bjerrum and Schwarzschild, 414.
 — Rowland, 453.
 — grating, 117.
 R-series, 431.
 Rubens, 418.
 Rubens and Wartenberg, 419.
 Rubinowicz, 313, 407.
 — principle of correspondence, 275.
 Runge, 391.
 and Grotrian, 429.
 Paschen, 380.
 — — Precht (K α -doublet), 377.
 — denominator, 385.
 — numerator, 387.
 — rule of, 385.
 Russell, 81.
 Rutherford, Sir Ernest, 13, 62, 79, 149, 232.
 — disintegration of nitrogen, 88, 91. ●
 — and Andrade, γ -ray spectrum of Ra, 145, 172, 449.
 — and Chadwick, 64.
 — Geiger, and Marsden, deflections of α -ray, 62, 65.
 — and Richardson, coefficient of scattering of γ -rays, 536.
 — Robinson, and Rawlinson, secondary α - and β -rays, 42.
 — and Soddy, decay theory of radioactive substances, 53.
 Rydberg, 59, 71, 329, 359, 379, 381.
 — constant, 201, 329, 375.
 — frequency, 155, 173.
 Rydberg-Ritz constant, 154, 204, 220, 316.
 Rydberg-Schuster law, 318.

S

- Sadler, 31.
 Saunders, 362, 375, 409.
 Scandium, 149.
 Scattering power, 121, 533. *See* Electrons.
 Schäfer and Neumann, 464.
 Schillinger, 374.
 Schmid, 71.
 Schönflies, arc spectra of alkalis, 117, 125.
 Schrödinger, s-term and ground spectra of alkalis, 329.
 Schumann, 353.
 Schuster. *See* Rydberg-Schuster.
 Schwarzschild, 413, 417.
 — degenerate cases, 564, 567, 568.
 — and Epstein, choice of co-ordinates, 276, 556, 592.
 — — — conditionally periodic motions, 201.
 Schweidler, 46.
 Screen constant or number (*Abschirmungszahl*), 498, 502, 507, 508, 509.
 Second subsidiary series of H, 207.
 Seeliger and Thaer, 379.
 Seeman, 134.
 Selection of inner quantum numbers, 365.

- Selection, principle of, 217, 240, 264 *et seq.*,
 273, 351, 483, 485, 521, 522, 581.
 Semi-spectroscopic units, 527.
Serienfremd, 389.
 Series, 202, 207, 314 *et seq.*
 — doublet, 231.
 — law of system, 437.
 — partial, 319.
 — principal, 207, 315.
 — Röntgen, 354.
 — scheme of, 336.
 — — — and electronic impact, 339.
 — subsidiary, 207, 315, 333.
 — terms, 187.
 — theorems, 321.
 Shadow pictures, 191.
 Shells, electrons in, 108, 109, 143.
 Siegbahn, 102, 127, 140, 151, 152, 173, 177,
 525.
 — and Friman, 152.
 — — Jönsson, 135, 185.
 — — Stenstrom, 152.
 Siegbahn's nomenclature, 159.
 Silver band, 184.
 Simultaneity, 459.
 Sletator, infra-red absorption spectra, 419.
 Smeak, non-existence of A-doublet, 172.
 — scheme of levels of Röntgen rays, 514,
 515.
 Soddy, displacement laws of radioactivity,
 81.
 Sohne, 117.
 Sommerfeld, 76, 230, 304, 313, 362, 373,
 400, 406, 594.
 — fine structure, 213, 237, 474, 521.
 — generation of Balmer lines, 237.
 — law of magneto-optic resolution, 390.
 — quantum integral, 200.
 — Stark effect, 592.
 Sommerfeld and Debye, 44.
 — — Wentzel, 507.
 Space-lattice, 115.
 Space-reflection, 128.
 Spark current, 333.
 — spectrum, 372.
 Spatial quantising, 242.
 Specific charge, 5, 14, 16.
 Spectra not of the H type (*wasserstoffun-
 ähnlich*), 596.
 Spectral lines, sharpness of, 562.
 Spectroscopic units, 217.
 — — semi-, 527.
 Spectrum, flame, arc, spark, 372, 481.
 Spherical top, 442.
 — wave, 255, 572.
 S-series, 431.
 Stark, 14, 313, 332, 333, 447.
 — effect, 237, 270, 276 *et seq.*, 310, 485.
 — — according to method of Hamilton
 and Jacobi, 587.
 — — components of, 291-295.
 Static length (*Ruhlänge*), 459.
 — mass (*Ruhmasse*) 6, 21, 461.
 — system of reference, 297, 301.
 Stationary orbits, 202.
 Statistics of intensity, 588.
 Stay, length of (*Verweilzeit*), 262, 353.
 Stenstrom, weak K-lines, 152, 525.
 Stenström, 102, 133, 173.
 — M-limits, 189.
 — rule, 141.
 Stokes' fluorescence rule, 141, 159, 179, 184.
 — lag, 179.
 Stoney, 5.
 Strengths of shells (= distribution numbers
 or *Besetzungszahlen*), 108, 143.
 Subsidiary series, 207, 315.
 Surface, in ($f+1$)-dimensions, 546.
 — Riemann, 551.
 — of atom, 448, 451.
 Swinnic, relation between L- and M-series
 174.
- ### T
- Takamine and Kokubu, Stark effect of
 second order, 594.
 — — Yamada, Zeeman effect of neon
 lines, 383, 391.
 Target point (*Treffpunkt*), 557.
 Tate and Foote, 345.
 Terms, 187, 314, 516.
 — constant and variable, 205, 314.
 Thiele, meaning of head of band, 428.
 Thomson, Sir J. J., researches on canal
 rays, 68.
 Thorium series, 45.
 Time-dilatation, Einstein's, 460.
 Time equation, 569.
 Time of stay (*Verweilzeit*), 262, 353, 431.
 Time, half-value, 46.
 Transformation potential, 349.
Treffpunkt = target point, 557.
 Triad of elements, 58.
 Triplets, 381.
 — Hydrogen, 506.
 Triplet systems, 366, 375, 401.
 — — differences of level, 371.
 Trouton and Noble, experiment, 454.
 Tungsten anti-cathode, 183.
- ### U
- Ubrey's intensity law, 179.
 Ultra-Bergmann series, 379.
Umlaufzahl = rotation number, 275.
Umwandlungsspannung = transformation
 potential, 349.
 Units, electromagnetic, 15, 25.
 — electrostatic, 15, 213.
 — rational, 255.
 — semi-spectroscopic, 527.
 — spectroscopic, 217, 525.
 Uranium series, 45, 50.
 Vacuum spectrograph, 135, 152.
 Valency electrons, 103.

- Variables, separation of, 555, 569, 590, 608.
 Variations, calculus of, 542, 557.
 Vegard, distribution numbers, 230.
 Velocity spectrum (= magnetic spectrum), 43, 449.
 Vorweilzeit (= length of stay), 262, 353, 431.
 Vibration circle, 261.
 — ellipse, 261, 572, 602.
 — fundamental plane of, 261, 264, 572.
 — numbers (frequencies), 154.
 Viellinienspektrum (Many lines spectrum), 209, 344.
 Violet shift of helium lines, 223.
 Virtual work, 512.
 Voigt, theory of anomalous Zeeman effect of: alkalis, 400, 401; quantum interpretation, 405.
 Voltaic current, 21.
- W**
- Wagner, L-series, 140.
 — 'Stokes' lag, 178.
 — wave-length of Röntgen rays, 127.
 Wagner and Brentano, bromine and silver edge, 183.
 Walter and Pohl, diffraction of Röntgen rays, 110.
 Warburg, 305.
 Wärmelönung, 349.
 Wasserstoffähnlich = of the hydrogen type, 203, 222.
 Wave, coherence of, 255, 262.
 — intensity of, 255.
 — length, measurement of, 129.
 — lengths, equal differences of, 161, 169.
 — numbers, 154, 175, 217, 294.
 — polarisation, 255.
 — theory, 253. *See also* Spherical wave.
 Weak fields, 388, 496.
 Weber, magnetic moment, 247.
 Webster, 178, 179, 180.
 Webster and Clarke, determination of h from excitation limits, 178.
 — — — excitation limits, 180.
 Webster and Duano, ionisation method, 135.
 Wehnelt tube, 9, 35.
 — hardness gauge, 192.
- Weinacht, spectra of atoms not of the hydrogen type, 600.
 Weiss, magnetic moment, 247.
 Weiss and Piccard, number of magnetons in paramagnetic gases, 251.
 Wentzel, irregular doublets, 510.
 — scheme of levels of Röntgen spectra, 515.
 — selection principle of Röntgen spectra, 522.
 — spark lines of Röntgen spectra, 525.
 Werner, 104.
 Width of impulse, 28, 111.
 Wien, researches on canal rays, 14.
 Wiener, 130.
 Wiess (*abklingen*), 262.
 Wilson, C. T. R., paths of α and β rays in gases, 17, 62.
 — paths of Röntgen rays, 28.
 Wilson, W., quantising several degrees of freedom, 96, 200, 235.
 Wind, 111.
 Winkler, 59.
 Wolf-Rayet nebulae, 225.
 Wood, 430, 447.
 Work of escape, 39, 418.
 World, 161.
- X-rays (= Röntgen rays) 15, 23.
 — hard, 32.
 X-units, 151.
- Young, 253.
- Zeeman effect, 237, 270, 310, 495.
 — — anomalous, 294 *et seq.*, 363, 381.
 — — of band spectra, 441, 446.
 — — longitudinal, 294.
 — — Lorentz's theory of, 295.
 — — transverse, 294.
 — — triplet, 294.
 — — types, anomalous, 296.
 Zenker, 130.
 Zero-line = null line of rotation bands, 419, 445.

PRINTED IN GREAT BRITAIN AT THE UNIVERSITY PRESS, ABERDEEN

