

**Digital Imaging and Communications in Medicine (DICOM)**  
**Part 16: Content Mapping Resource**

*Published by*

**National Electrical Manufacturers Association**  
1300 N. 17th Street  
Rosslyn, Virginia 22209 USA

© Copyright 2007 by the National Electrical Manufacturers Association. All rights including translation into other languages, reserved under the Universal Copyright Convention, the Berne Convention for the Protection of Literacy and Artistic Works, and the International and Pan American Copyright Conventions.

## NOTICE AND DISCLAIMER

The information in this publication was considered technically sound by the consensus of persons engaged in the development and approval of the document at the time it was developed. Consensus does not necessarily mean that there is unanimous agreement among every person participating in the development of this document.

NEMA standards and guideline publications, of which the document contained herein is one, are developed through a voluntary consensus standards development process. This process brings together volunteers and/or seeks out the views of persons who have an interest in the topic covered by this publication. While NEMA administers the process and establishes rules to promote fairness in the development of consensus, it does not write the document and it does not independently test, evaluate, or verify the accuracy or completeness of any information or the soundness of any judgments contained in its standards and guideline publications.

NEMA disclaims liability for any personal injury, property, or other damages of any nature whatsoever, whether special, indirect, consequential, or compensatory, directly or indirectly resulting from the publication, use of, application, or reliance on this document. NEMA disclaims and makes no guaranty or warranty, expressed or implied, as to the accuracy or completeness of any information published herein, and disclaims and makes no warranty that the information in this document will fulfill any of your particular purposes or needs. NEMA does not undertake to guarantee the performance of any individual manufacturer or seller's products or services by virtue of this standard or guide.

In publishing and making this document available, NEMA is not undertaking to render professional or other services for or on behalf of any person or entity, nor is NEMA undertaking to perform any duty owed by any person or entity to someone else. Anyone using this document should rely on his or her own independent judgment or, as appropriate, seek the advice of a competent professional in determining the exercise of reasonable care in any given circumstances. Information and other standards on the topic covered by this publication may be available from other sources, which the user may wish to consult for additional views or information not covered by this publication.

NEMA has no power, nor does it undertake to police or enforce compliance with the contents of this document. NEMA does not certify, test, or inspect products, designs, or installations for safety or health purposes. Any certification or other statement of compliance with any health or safety-related information in this document shall not be attributable to NEMA and is solely the responsibility of the certifier or maker of the statement.

## CONTENTS

NOTICE AND DISCLAIMER .....	2
CONTENTS .....	3
FOREWORD .....	20
1 Scope and field of application.....	22
2 Normative references .....	22
3 Definitions .....	25
3.1 CODES AND CONTROLLED TERMINOLOGY DEFINITIONS:.....	25
3.2 INFORMATION OBJECT DEFINITIONS: .....	26
4 Symbols and abbreviations .....	26
5 Conventions.....	27
6 Form of Template Specifications .....	27
6.1 TEMPLATE TABLE FIELD DEFINITION .....	28
6.1.1 ....Row Number .....	29
6.1.2 ....Nesting Level (NL) .....	29
6.1.3 ....Relationship with Source Content Item (Parent).....	30
6.1.4 ....Value Type (VT).....	30
6.1.5 ....Concept Name .....	30
6.1.6 ....Value Multiplicity (VM).....	30
6.1.7 ....Requirement Type.....	31
6.1.8 ....Condition .....	31
6.1.9 ....Value Set Constraint .....	31
6.2 SPECIAL CONVENTIONS FOR TEMPLATE TABLES .....	32
6.2.1 ....Multiple Value Sets Depending on Different Conditions .....	32
6.2.2 ....Target Content Items of Relationships.....	32
6.2.3 ....Inclusion of Templates .....	33
6.2.4 ....Post-coordinated Codes and Has Concept Modifier Relationship.....	34
6.2.5 ....Extension of Templates .....	34
7 DCMR Context Group Specifications .....	34
7.1 CONTEXT GROUP TABLE FIELD DEFINITION .....	34
7.2 SPECIAL CONVENTIONS FOR CONTEXT GROUP TABLES.....	35
7.2.1 ....Include Context Group .....	35
7.2.2 ....Units Of Measurement .....	36
7.2.3 ....Extension of Context Groups .....	36
8 Coding Schemes .....	37
Annex A Structured Reporting Templates (Normative).....	40
GENERAL TEMPLATES .....	40
TID 300Measurement .....	40
TID 310Measurement Properties.....	41
TID 311Measurement Statistical Properties .....	42
TID 312Normal Range Properties .....	42
TID 315Equation or Table.....	43
TID 320Image or Spatial Coordinates .....	44
TID 321Waveform or Temporal Coordinates.....	44
TID 350 References to Supporting Evidence .....	45
TID 351 Previous Reports.....	45
TID 1000 Quotation .....	46

TID 1001	Observation Context.....	46
TID 1002	Observer Context.....	47
TID 1003	Person Observer Identifying Attributes.....	48
TID 1004	Device Observer Identifying Attributes.....	48
TID 1005	Procedure Context.....	49
TID 1006	Subject Context.....	49
TID 1007	Subject Context, Patient.....	50
TID 1008	Subject Context, Fetus.....	51
TID 1009	Subject Context, Specimen.....	51
TID 1200	Language Designation.....	52
TID 1201	Language of Value.....	52
TID 1202	Language of Name and Value.....	53
TID 1204	Language of Content Item and Descendants.....	53
TID 1210	Equivalent Meaning(s) of Concept Name.....	53
TID 1211	Equivalent Meaning(s) of Value.....	54
TID 1350	Negation Modifier, Presence of Finding.....	56
TID 1400	Linear Measurement Template.....	57
TID 1401	Area Measurement Template.....	57
TID 1402	Volume Measurement Template.....	58
TID 1404	Numeric Measurement Template.....	59
TID 2000	Basic Diagnostic Imaging Report.....	60
TID 2001	Basic Diagnostic Imaging Report Observations.....	60
TID 2005	Transcribed Diagnostic Imaging Report.....	61
TID 2010	Key Object Selection.....	62
PROCEDURE LOG IOD TEMPLATES.....		64
TID 3001	Procedure Log.....	64
TID 3010	Log Entry Qualifiers.....	65
TID 3100	Procedure Action.....	66
TID 3101	Image Acquisition.....	67
TID 3102	Waveform Acquisition.....	68
TID 3103	Referenced Object.....	68
TID 3104	Consumables.....	69
TID 3105	Lesion Identification and Properties.....	69
TID 3106	Drugs/Contrast Administered.....	70
TID 3107	Device Used.....	71
TID 3108	Intervention.....	71
TID 3109	Measurements.....	72
TID 3110	Impressions or Findings.....	72
TID 3111	Percutaneous Entry.....	73
TID 3112	Specimen Obtained.....	73
TID 3113	Patient Support.....	74
TID 3114	Patient Assessment.....	75
TID 3115	ECG ST Assessment.....	76
QUANTITATIVE VENTRICULAR ANALYSIS REPORT SR IOD TEMPLATES.....		77
TID 3202	Ventricular Analysis Template.....	77
TID 3205	Calibration Template.....	78
TID 3206	VA Main Results Template.....	79
TID 3207	AA Main Results Template.....	82
TID 3208	Frame-to-Frame Results Template.....	82
TID 3209	Centerline Wall Motion Template.....	83
TID 3210	Radial Based Wall Motion Template.....	84
TID 3211	Landmark Based Wall Motion Template.....	85
QUANTITATIVE ARTERIAL ANALYSIS REPORT SR IOD TEMPLATES.....		87
TID 3213	Quantitative Arterial Analysis Template.....	87
TID 3214	Analyzed Segment Template.....	88
TID 3215	Angiographic Lesion Analysis Template.....	90

TID 3216	Stenotic Flow Reserve Template .....	93
TID 3217	Sub-segmental Data Template.....	93
TID 3218	Position in Arterial Segment .....	94
TID 3219	Segment Values Template .....	95
IVUS REPORT TEMPLATES .....		96
TID 3250	IVUS Report .....	97
TID 3251	IVUS Vessel .....	97
TID 3252	IVUS Lesion.....	98
TID 3253	IVUS Measurements .....	98
TID 3254	IVUS Qualitative Assessments.....	99
TID 3255	IVUS Volume Measurement.....	100
HEMODYNAMICS REPORT TEMPLATES .....		101
TID 3500	Hemodynamics Report.....	102
TID 3501	Hemodynamics Measurement Group.....	102
TID 3504	Arterial Pressure Measurement.....	103
TID 3505	Atrial Pressure Measurement.....	104
TID 3506	Venous Pressure Measurement.....	105
TID 3507	Ventricular Pressure Measurement.....	105
TID 3508	Gradient Measurement.....	106
TID 3509	Blood Velocity Measurement.....	107
TID 3510	Vital Signs.....	108
TID 3515	Cardiac Output Measurement by Indicator Dilution .....	109
TID 3516	Blood Lab Measurements.....	109
TID 3520	Hemodynamic Clinical Context .....	110
TID 3521	Relative Time.....	111
TID 3530	Hemodynamic Acquisition Context.....	112
TID 3550	Pressure Waveform Measurements .....	112
TID 3560	Derived Hemodynamic Measurements .....	114
TID 3570	Summary, Hemodynamics .....	116
TID 3601	Procedure Context.....	117
TID 3602	Cardiovascular Patient Characteristics .....	117
TID 3603	Procedure Environmental Characteristics .....	118
ECG REPORT TEMPLATES .....		119
TID 3700	ECG Report .....	119
TID 3701	Clinical Context, ECG.....	119
TID 3702	Prior ECG Exam .....	120
TID 3708	ECG Waveform Information .....	120
TID 3713	ECG Global Measurements.....	121
TID 3714	ECG Lead Measurements .....	122
TID 3715	ECG Measurement Source .....	123
TID 3717	ECG Qualitative Analysis .....	123
TID 3718	ECG Interpretive Statement .....	124
TID 3719	Summary, ECG .....	124
CATH LAB CLINICAL REPORT TEMPLATES .....		125
TID 3800	Cardiac Catheterization Report Root .....	125
TID 3802	Cardiovascular Patient History .....	126
TID 3803	Patient Presentation, Cath.....	127
TID 3806	Cath Procedure .....	128
TID 3807	Percutaneous Coronary Intervention Procedure.....	129
TID 3808	Lesion Intervention Information .....	130
TID 3809	Other Interventional Procedures .....	131
TID 3810	Cardiac Catheterization Findings .....	132
TID 3812	Hemodynamic Findings.....	133
TID 3814	Left Ventriculography Findings.....	133
TID 3815	Right Ventriculography Findings .....	134
TID 3816	Ventricular Assessment.....	135

TID 3817	Coronary Arteriography Findings .....	135
TID 3818	Other Cardiographic Findings .....	136
TID 3819	Common Findings .....	137
TID 3820	Adverse Outcomes, Cath .....	137
TID 3824	Summary, Cath.....	138
TID 3828	Discharge Summary, Cath .....	138
CT/MR CARDIOVASCULAR ANALYSIS REPORT TEMPLATES .....		140
TID 3900	CT/MR Cardiovascular Analysis Report .....	140
TID 3901	Procedure Summary .....	140
TID 3902	Vascular Analysis.....	140
TID 3905	Calcium Scoring Results.....	143
TID 3906	Vascular Section Measurements .....	144
TID 3907	Vessel Measurements.....	145
TID 3908	Vascular Lesion.....	145
TID 3909	Best Illustration of Findings.....	147
TID 3910	Flow Quantification.....	147
TID 3911	Plaque Properties.....	148
TID 3912	Stenosis Properties.....	149
TID 3913	Aneurysm Properties.....	149
TID 3914	Arterial Dissection Properties.....	150
TID 3915	Vascular Occlusion Properties .....	150
TID 3916	Stent Properties .....	151
TID 3917	Aneurysm Measurements .....	151
TID 3920	Ventricular Analysis.....	151
TID 3921	Ventricular Measurements .....	152
TID 3922	Absolute Values Of Ventricular Measurements .....	153
TID 3923	BSA-Normalized Ventricular Measurements .....	154
TID 3924	Heart Rate-Normalized Ventricular Measurements .....	154
TID 3925	Ventricular Thickening Analysis .....	155
TID 3926	Myocardial Perfusion Analysis .....	156
TID 3927	Report Summary .....	157
TID 3929	Cardiovascular Analysis Observation Context.....	157
TID 3990	2-Dimensional Measurement Graph.....	158
MAMMOGRAPHY CAD SR IOD TEMPLATES.....		159
TID 4000	Mammography CAD Document Root Template .....	160
TID 4001	Mammography CAD Overall Impression/Recommendation Template .....	161
TID 4002	Mammography CAD Impression/Recommendation Body Template .....	162
TID 4003	Mammography CAD Individual Impression/Recommendation Template .....	163
TID 4004	Mammography CAD Composite Feature Template.....	164
TID 4005	Mammography CAD Composite Feature Body Template .....	165
TID 4006	Mammography CAD Single Image Finding Template .....	168
TID 4007	Mammography CAD Breast Composition Template.....	171
TID 4008	Mammography CAD Breast Geometry Template .....	171
TID 4009	Mammography CAD Individual Calcification Template.....	172
TID 4010	Mammography CAD Calcification Cluster Template .....	172
TID 4011	Mammography CAD Density Template .....	173
TID 4012	Mammography CAD Non-Lesion Template .....	174
TID 4013	Mammography CAD Selected Region Template.....	174
TID 4014	CAD Image Quality Template.....	174
TID 4015	CAD Detections Performed Template .....	175
TID 4016	CAD Analyses Performed Template .....	176
TID 4017	CAD Detection Performed Template.....	176
TID 4018	CAD Analysis Performed Template.....	177
TID 4019	CAD Algorithm Identification Template .....	178
TID 4020	CAD Image Library Entry Template .....	180
TID 4021	Mammography CAD Geometry Template.....	182
TID 4022	CAD Observation Context Template.....	182

TID 4023	CAD Operating Points .....	182
CHEST CAD SR IOD TEMPLATES .....		184
TID 4100	Chest CAD Document Root Template .....	185
TID 4101	Chest CAD Findings Summary Template .....	187
TID 4102	Chest CAD Composite Feature Template .....	188
TID 4103	Chest CAD Composite Feature Body Template .....	190
TID 4104	Chest CAD Single Image Finding Template .....	192
TID 4105	Chest CAD Descriptors .....	194
TID 4106	Response Evaluation .....	194
TID 4107	Chest CAD Geometry Template .....	195
TID 4108	Tracking Identifier.....	196
BREAST IMAGING REPORT TEMPLATES .....		197
TID 4200	Breast Imaging Report .....	198
TID 4201	Breast Imaging Procedure Reported .....	199
TID 4202	Breast Imaging Report Narrative .....	200
TID 4203	Breast Imaging Assessment .....	201
TID 4204	Breast Imaging Report Intervention Section .....	202
TID 4205	Breast Composition Section.....	204
TID 4206	Breast Imaging Report Finding Section .....	205
TID 4207	Breast Imaging Pathology Results.....	207
TID 4208	Breast Imaging Report Supplementary Data .....	208
OB-GYN REPORT TEMPLATES .....		209
TID 5000	OB-GYN Ultrasound Procedure Report .....	209
TID 5001	OB-GYN Patient Characteristics .....	210
TID 5002	OB-GYN Procedure Summary Section .....	210
TID 5003	OB-GYN Fetus Summary.....	210
TID 5004	Fetal Biometry Ratio Section.....	211
TID 5005	Fetal Biometry Section .....	211
TID 5006	Fetal Long Bones Section.....	212
TID 5007	Fetal Cranium Section.....	212
TID 5008	Fetal Biometry Group .....	213
TID 5009	Fetal Biophysical Profile Section.....	214
TID 5010	Amniotic Sac Section .....	214
TID 5011	Early Gestation Section.....	215
TID 5012	Ovaries Section.....	215
TID 5013	Follicles Section .....	216
TID 5014	Follicle Measurement Group .....	216
TID 5015	Pelvis and Uterus Section.....	217
TID 5016	LWH Volume Group .....	217
TID 5025	OB-GYN Fetal Vascular Ultrasound Measurement Group .....	218
TID 5026	OB-GYN Pelvic Vascular Ultrasound Measurement Group.....	218
VASCULAR ULTRASOUND REPORT TEMPLATES .....		220
TID 5100	Vascular Ultrasound Report .....	220
TID 5101	Vascular Patient Characteristics .....	222
TID 5102	Vascular Procedure Summary Section .....	223
TID 5103	Vascular Ultrasound Section.....	223
TID 5104	Vascular Ultrasound Measurement Group.....	224
TID 5105	Ultrasound Graft Section.....	225
ECHOCARDIOGRAPHY PROCEDURE REPORT TEMPLATES .....		225
TID 5200	Echocardiography Procedure Report.....	225
TID 5201	Echocardiography Patient Characteristics .....	227
TID 5202	Echo Section .....	227
TID 5203	Echo Measurement .....	228
TID 5204	Echocardiography Wall Motion Analysis.....	229
RELEVANT PATIENT INFORMATION TEMPLATES.....		231

TID 9000	Relevant Patient Information For Breast Imaging .....	231
TID 9001	Gynecological History .....	232
TID 9002	Medication, Substance, Environmental Exposure .....	233
TID 9003	Previous Procedure.....	235
TID 9004	Indicated Problem .....	237
TID 9005	Risk Factor .....	238
TID 9006	Obstetric History.....	239
TID 9007	General Relevant Patient Information.....	239
X-RAY RADIATION DOSE SR IOD TEMPLATES.....		240
TID 10001	Projection X-Ray Radiation Dose .....	241
TID 10002	Accumulated X-Ray Dose.....	242
TID 10003	Irradiation Event X-Ray Data .....	243
Annex B	DCMR Context Groups (Normative).....	247
CID 2	...Anatomic Modifier .....	247
CID 4	...Anatomic Region.....	248
CID 5	...Transducer Approach.....	250
CID 6	...Transducer Orientation .....	252
CID 7	...Ultrasound Beam Path.....	252
CID 8	...Angiographic Interventional Devices.....	253
CID 9	...Image Guided Therapeutic Procedures .....	253
CID 10	...Interventional Drug.....	254
CID 11	...Route of Administration.....	256
CID 12	...Radiographic Contrast Agent.....	256
CID 13	...Radiographic Contrast Agent Ingredient.....	258
CID 18	...Isotopes in Radiopharmaceuticals .....	258
CID 19	...Patient Orientation .....	259
CID 20	...Patient Orientation Modifier .....	259
CID 21	...Patient Gantry Relationship .....	260
CID 23	...Cranio-caudad Angulation .....	260
CID 25	...Radiopharmaceuticals .....	261
CID 26	...Nuclear Medicine Projections .....	263
CID 29	...Acquisition Modality .....	264
CID 30	...DICOM Devices .....	265
CID 31	...Abstract Priors.....	266
CID 42	...Numeric Value Qualifier .....	267
CID 82	...Units of Measurement.....	267
CID 83	...Units for Real World Value Mapping.....	267
CID 220	Level of Significance.....	267
CID 221	Measurement Range Concepts.....	268
CID 222	Normality Codes .....	268
CID 223	Normal Range Values .....	268
CID 224	Selection Method.....	269
CID 225	Measurement Uncertainty Concepts .....	269
CID 226	Population Statistical Descriptors.....	269
CID 227	Sample Statistical Descriptors.....	270
CID 228	Equation or Table .....	270
CID 230	Yes-No.....	270
CID 240	Present-Absent.....	270
CID 242	Normal-Abnormal .....	271
CID 244	Laterality .....	271
CID 250	Positive-Negative.....	271
CID 251	Severity of Complication.....	272
CID 270	Observer Type.....	272
CID 271	Observation Subject Class .....	272
CID 3000	Audio Channel Source .....	272
CID 3001	ECG Leads.....	273
CID 3003	Hemodynamic Waveform Sources .....	275



CID 3010	Cardiovascular Anatomic Locations.....	276
CID 3011	Electrophysiology Anatomic Locations .....	279
CID 3014	Coronary Artery Segments .....	280
CID 3015	Coronary Arteries .....	282
CID 3019	Cardiovascular Anatomic Location Modifiers.....	282
CID 3082	Cardiology Units of Measurement.....	283
CID 3090	Time Synchronization Channel Types .....	284
CID 3101	NM Procedural State Values.....	284
CID 3240	Electrophysiology Measurement Functions and Techniques .....	284
CID 3241	Hemodynamic Measurement Techniques .....	285
CID 3250	Catheterization Procedure Phase.....	285
CID 3254	Electrophysiology Procedure Phase.....	286
CID 3261	Stress Protocols .....	286
CID 3262	ECG Patient State Values.....	286
CID 3263	Electrode Placement Values.....	287
CID 3264	XYZ Electrode Placement Values.....	287
CID 3271	Hemodynamic Physiological Challenges .....	288
CID 3335	ECG Annotations .....	288
CID 3337	Hemodynamic Annotations .....	289
CID 3339	Electrophysiology Annotations.....	290
CID 3400	Procedure Log Titles.....	290
CID 3401	Types of Log Notes.....	290
CID 3402	Patient Status and Events.....	291
CID 3403	Percutaneous Entry .....	292
CID 3404	Staff Actions.....	292
CID 3405	Procedure Action Values .....	292
CID 3406	Non-Coronary Transcatheter Interventions .....	293
CID 3407	Purpose of Reference to Object.....	293
CID 3408	Actions with Consumables.....	293
CID 3409	Administration of Drugs/Contrast.....	294
CID 3410	Numeric Parameters of Drugs/Contrast.....	294
CID 3411	Intracoronary Devices .....	295
CID 3412	Intervention Actions and Status .....	295
CID 3413	Adverse Outcomes .....	296
CID 3414	Procedure Urgency .....	296
CID 3415	Cardiac Rhythms.....	296
CID 3416	Respiration Rhythms.....	298
CID 3418	Lesion Risk.....	298
CID 3419	Findings Titles .....	298
CID 3421	Procedure Action .....	299
CID 3422	Device Use Actions .....	299
CID 3423	Numeric Device Characteristics.....	299
CID 3425	Intervention Parameters.....	300
CID 3426	Consumables Parameters .....	300
CID 3427	Equipment Events.....	300
CID 3428	Imaging Procedures.....	301
CID 3429	Catheterization Devices .....	301
CID 3430	DateTime Qualifiers .....	302
CID 3440	Peripheral Pulse Locations .....	302
CID 3441	Patient assessments.....	302
CID 3442	Peripheral Pulse Methods.....	303
CID 3446	Skin Condition .....	303
CID 3448	Airway Assessment.....	303
CID 3451	Calibration Objects.....	304
CID 3452	Calibration Methods.....	304
CID 3453	Volume Methods .....	304
CID 3455	Index Methods.....	305

CID 3456	Sub-segment Methods .....	305
CID 3458	Contour Realignment .....	305
CID 3460	Circumferential Extent .....	305
CID 3461	Regional Extent .....	306
CID 3462	Chamber Identification .....	306
CID 3465	QA Reference MethodS .....	306
CID 3466	Plane Identification .....	307
CID 3467	Ejection Fraction .....	307
CID 3468	ED Volume .....	308
CID 3469	ES Volume .....	308
CID 3470	Vessel Lumen Cross-Sectional Area Calculation Methods .....	308
CID 3471	Estimated Volumes .....	308
CID 3472	Contraction Phase .....	309
CID 3480	IVUS Procedure Phases .....	309
CID 3481	IVUS Distance Measurements .....	309
CID 3482	IVUS Area Measurements .....	310
CID 3483	IVUS Longitudinal Measurements .....	310
CID 3484	IVUS Indices and Ratios .....	310
CID 3485	IVUS Volume Measurements .....	311
CID 3486	Vascular Measurement Sites .....	311
CID 3487	IVUS Volumetric Regions .....	311
CID 3488	Min/Max/Mean .....	312
CID 3489	Calcium Distribution .....	312
CID 3491	IVUS Lesion Morphologies .....	312
CID 3492	Vascular Dissection Classifications .....	313
CID 3493	IVUS Relative Stenosis Severities .....	313
CID 3494	IVUS Non Morphological Findings .....	314
CID 3495	IVUS Plaque Composition .....	314
CID 3496	IVUS Fiducial Points .....	314
CID 3497	IVUS Arterial Morphology .....	315
CID 3500	Pressure Units .....	315
CID 3502	Hemodynamic Resistance Units .....	315
CID 3503	Indexed Hemodynamic Resistance Units .....	315
CID 3510	Catheter Size Units .....	315
CID 3515	Specimen Collection .....	316
CID 3520	Blood Source Type .....	316
CID 3524	Blood Gas Pressures .....	316
CID 3525	Blood Gas Content .....	317
CID 3526	Blood Gas Saturation .....	317
CID 3527	Blood Base Excess .....	317
CID 3528	Blood pH .....	318
CID 3529	Arterial / Venous Content .....	318
CID 3530	Oxygen Administration Actions .....	318
CID 3531	Oxygen Administration .....	319
CID 3550	Circulatory Support Actions .....	319
CID 3551	Ventilation Actions .....	319
CID 3552	Pacing Actions .....	319
CID 3553	Circulatory Support .....	320
CID 3554	Ventilation .....	320
CID 3555	Pacing .....	320
CID 3560	Blood Pressure Methods .....	321
CID 3600	Relative times .....	321
CID 3602	Hemodynamic Patient State .....	321
CID 3604	Arterial lesion locations .....	322
CID 3606	Arterial source locations .....	322
CID 3607	Venous Source locations .....	324
CID 3608	Atrial source locations .....	325

CID 3609	Ventricular source locations.....	325
CID 3610	Gradient Source Locations .....	326
CID 3611	Pressure Measurements .....	326
CID 3612	Blood Velocity Measurements .....	327
CID 3613	Hemodynamic Time Measurements .....	327
CID 3614	Valve Areas, non-Mitral.....	327
CID 3615	Valve Areas.....	328
CID 3616	Hemodynamic Period Measurements.....	328
CID 3617	Valve Flows.....	328
CID 3618	Hemodynamic Flows.....	329
CID 3619	Hemodynamic Resistance Measurements .....	329
CID 3620	Hemodynamic Ratios.....	329
CID 3621	Fractional Flow Reserve .....	330
CID 3627	Measurement Type .....	330
CID 3628	Cardiac Output Methods .....	330
CID 3629	Procedure Intent .....	331
CID 3630	Cardiovascular Anatomic Locations.....	331
CID 3640	Hypertension.....	331
CID 3641	Hemodynamic Assessments.....	331
CID 3642	Degree Findings.....	332
CID 3651	Hemodynamic Measurement Phase.....	332
CID 3663	Body Surface Area Equations.....	333
CID 3664	Oxygen Consumption Equations and Tables .....	333
CID 3666	P50 Equations.....	333
CID 3667	Framingham Scores.....	334
CID 3668	Framingham Tables .....	334
CID 3670	ECG Procedure Types.....	334
CID 3671	Reason for ECG Exam .....	335
CID 3672	Pacemakers .....	335
CID 3673	Diagnosis .....	335
CID 3675	Other Filters .....	336
CID 3676	Lead Measurement Technique .....	336
CID 3677	Summary Codes ECG .....	337
CID 3678	QT Correction Algorithms .....	337
CID 3679	ECG Morphology Descriptions.....	337
CID 3680	ECG Lead Noise Descriptions .....	338
CID 3681	ECG Lead Noise Modifiers .....	338
CID 3682	Probability .....	339
CID 3683	Modifiers.....	339
CID 3684	Trend.....	340
CID 3685	Conjunctive Terms .....	341
CID 3686	ECG Interpretive Statements.....	342
CID 3687	Electrophysiology Waveform Durations .....	351
CID 3688	Electrophysiology Waveform Voltages .....	351
CID 3700	Cath Diagnosis.....	352
CID 3701	Cardiac Valves and Tracts.....	353
CID 3703	Wall Motion .....	354
CID 3704	Myocardium Wall Morphology Findings .....	354
CID 3705	Chamber Size .....	354
CID 3706	Overall Contractility.....	355
CID 3707	VSD Description.....	355
CID 3709	Aortic Root Description .....	355
CID 3710	Coronary Dominance .....	356
CID 3711	Valvular Abnormalities .....	356
CID 3712	Vessel Descriptors .....	356
CID 3713	TIMI Flow Characteristics .....	357
CID 3714	Thrombus.....	357

CID 3715	Lesion Margin.....	358
CID 3716	Severity .....	358
CID 3717	Myocardial Wall Segments .....	358
CID 3718	Myocardial Wall Segments in Projection .....	359
CID 3719	Canadian Clinical Classification.....	360
CID 3720	Cardiac History Dates .....	360
CID 3721	Cath Patient History .....	360
CID 3722	Diabetic Therapy .....	360
CID 3723	MI Types .....	361
CID 3724	Smoking History .....	361
CID 3726	Indications for Coronary Intervention.....	362
CID 3727	Indications for Catheterization .....	362
CID 3728	Cath Findings .....	362
CID 3729	Admission Status .....	364
CID 3730	Insurance Payor .....	364
CID 3733	Primary Cause of Death.....	364
CID 3735	Acute Coronary Syndrome Time Period .....	365
CID 3736	NYHA Classification.....	365
CID 3737	Non-Invasive Test - Ischemia .....	365
CID 3738	Pre-Cath Angina Type .....	366
CID 3739	Cath Procedure Type.....	366
CID 3740	Thrombolytic Administration.....	366
CID 3741	Medication Administration, Lab Visit.....	367
CID 3742	Medication Administration, PCI.....	367
CID 3743	Clopidogrel/Ticlopidine Administration.....	368
CID 3744	EF Testing Method.....	368
CID 3745	Calculation Method .....	368
CID 3746	Percutaneous Entry .....	369
CID 3747	Percutaneous Closure .....	369
CID 3748	Angiographic EF Testing Method.....	369
CID 3749	PCI Procedure Result .....	370
CID 3750	Previously Dilated Lesion.....	370
CID 3752	Guidewire Crossing.....	370
CID 3754	Vascular Complications .....	371
CID 3755	Cath Complications.....	371
CID 3756	Cath Patient Risk Factors .....	372
CID 3802	Plaque Structures .....	372
CID 3804	Stenosis Measurement Methods .....	373
CID 3805	Stenosis Types.....	373
CID 3806	Stenosis Shape .....	373
CID 3807	Volume Measurement Methods .....	374
CID 3808	Aneurysm Types .....	374
CID 3809	Associated Conditions .....	375
CID 3810	Vascular Morphology .....	375
CID 3813	Stent Findings .....	376
CID 3814	Stent Composition.....	376
CID 3815	Source of Vascular Finding.....	376
CID 3817	Vascular Sclerosis Types.....	377
CID 3820	Non-invasive Vascular Procedures.....	378
CID 3821	Papillary Muscle Included/Excluded .....	378
CID 3823	Respiratory Status .....	378
CID 3826	Heart Rhythm .....	379
CID 3827	Vessel Segments .....	379
CID 3829	Pulmonary Arteries .....	380
CID 3831	Stenosis Length .....	380
CID 3832	Stenosis Grade .....	380
CID 3833	Cardiac Ejection Fraction.....	381

CID 3835	Volume Measurements .....	381
CID 3836	Time-based Perfusion Measurements .....	381
CID 3837	Fiducial Feature .....	382
CID 3838	Diameter Derivation .....	382
CID 3839	Coronary Veins .....	383
CID 3840	Pulmonary Veins .....	383
CID 3843	Myocardial Subsegment .....	384
CID 4005	Partial View Section for Mammography .....	384
CID 4009	DX Anatomy Imaged .....	384
CID 4010	DX View .....	384
CID 4011	DX View Modifier .....	386
CID 4012	Projection Eponymous Name .....	387
CID 4013	Anatomic Region for Mammography .....	389
CID 4014	View for Mammography .....	390
CID 4015	View Modifier for Mammography .....	390
CID 4016	Anatomic Region for Intra-oral Radiography .....	391
CID 4017	Anatomic Region Modifier for Intra-oral Radiography .....	391
CID 4018	Primary Anatomic Structure for Intra-oral Radiography (Permanent Dentition – Designation of Teeth) .....	392
CID 4019	Primary Anatomic Structure for Intra-oral Radiography (Deciduous Dentition – Designation of Teeth) .....	393
CID 4020	PET Radionuclide .....	393
CID 4021	PET Radiopharmaceutical .....	394
CID 4030	CT and MR Anatomy Imaged .....	394
CID 4031	Common Anatomic Regions .....	395
CID 4032	MR Spectroscopy Metabolites .....	398
CID 4033	MR Proton Spectroscopy Metabolites .....	398
CID 4040	Endoscopy Anatomic Regions .....	399
CID 4042	XA/XRF Anatomy Imaged .....	400
CID 4051	General Devices .....	400
CID 4052	Phantom Devices .....	400
CID 4200	Ophthalmic Imaging Agent .....	401
CID 4201	Patient Eye Movement Command .....	401
CID 4202	Ophthalmic Photography Acquisition Device .....	402
CID 4203	Ophthalmic Photography Illumination .....	402
CID 4204	Ophthalmic Filter .....	402
CID 4205	Ophthalmic Lens .....	403
CID 4206	Ophthalmic Channel Description .....	403
CID 4207	Ophthalmic Image Position .....	404
CID 4208	Mydriatic Agent .....	404
CID 4209	Ophthalmic Anatomic Structure Imaged .....	405
CID 5000	Languages .....	406
CID 5001	Countries .....	406
CID 6000	Overall Breast Composition .....	407
CID 6001	Overall Breast Composition from BI-RADS® .....	407
CID 6002	Change Since Last Mammogram or Prior Surgery .....	407
CID 6003	Change Since Last Mammogram or Prior Surgery from BI-RADS® .....	407
CID 6004	Mammography Characteristics of Shape .....	408
CID 6005	Characteristics of Shape from BI-RADS® .....	408
CID 6006	Mammography Characteristics of Margin .....	409
CID 6007	Characteristics of Margin from BI-RADS® .....	409
CID 6008	Density Modifier .....	409
CID 6009	Density Modifier from BI-RADS® .....	409
CID 6010	Mammography Calcification Types .....	410
CID 6011	Calcification Types from BI-RADS® .....	410
CID 6012	Calcification Distribution Modifier .....	411
CID 6013	Calcification Distribution Modifier from BI-RADS® .....	411

CID 6014	Mammography Single Image Finding .....	411
CID 6015	Single Image Finding from BI-RADS®.....	412
CID 6016	Mammography Composite Feature .....	412
CID 6017	Composite Feature from BI-RADS®.....	413
CID 6018	Clockface Location or Region .....	413
CID 6019	Clockface Location or Region from BI-RADS® .....	413
CID 6020	Quadrant Location .....	414
CID 6021	Quadrant Location from BI-RADS®.....	414
CID 6022	Side .....	415
CID 6023	Side from BI-RADS® .....	415
CID 6024	Depth.....	415
CID 6025	Depth from BI-RADS® .....	415
CID 6026	Mammography Assessment .....	416
CID 6027	Assessment from BI-RADS®.....	416
CID 6028	Mammography Recommended Follow-up .....	417
CID 6029	Recommended Follow-up from BI-RADS® .....	417
CID 6030	Mammography Pathology Codes.....	418
CID 6031	Benign Pathology Codes from BI-RADS®.....	418
CID 6032	High Risk Lesions Pathology Codes from BI-RADS®.....	420
CID 6033	Malignant Pathology Codes from BI-RADS® .....	421
CID 6034	Intended Use of CAD Output .....	423
CID 6035	Composite Feature Relations .....	423
CID 6036	Scope of Feature.....	423
CID 6037	Mammography Quantitative Temporal Difference Type .....	424
CID 6038	Mammography Qualitative Temporal Difference Type .....	424
CID 6039	Nipple Characteristic.....	424
CID 6040	Non-Lesion Object Type .....	425
CID 6041	Mammography Image Quality Finding .....	425
CID 6042	Status of Results .....	427
CID 6043	Types of Mammography CAD Analysis .....	427
CID 6044	Types of Image Quality Assessment .....	428
CID 6045	Mammography Types of Quality Control Standard.....	428
CID 6046	Units of Follow-up Interval .....	429
CID 6047	CAD Processing and Findings Summary .....	429
CID 6048	CAD Operating Point Axis Label.....	429
CID 6050	Breast Procedure Reported .....	430
CID 6051	Breast Procedure Reason.....	430
CID 6052	Breast Imaging Report section title.....	431
CID 6053	Breast Imaging Report Elements .....	432
CID 6054	Breast Imaging Findings .....	432
CID 6055	Breast Clinical Finding or Indicated Problem.....	432
CID 6056	Associated Findings for Breast .....	433
CID 6057	Ductography Findings for Breast .....	433
CID 6058	Procedure Modifiers for Breast .....	434
CID 6059	Breast Implant Types .....	434
CID 6060	Breast Biopsy Techniques .....	435
CID 6061	Breast Imaging Procedure Modifiers .....	435
CID 6062	Interventional Procedure Complications .....	436
CID 6063	Interventional Procedure Results.....	436
CID 6064	Ultrasound Findings for Breast .....	437
CID 6065	Instrument Approach.....	437
CID 6066	Target Confirmation .....	438
CID 6067	Fluid Color.....	438
CID 6068	Tumor Stages from AJCC.....	439
CID 6069	Nottingham Combined Histologic Grade .....	439
CID 6070	Bloom-Richardson Histologic Grade.....	439
CID 6071	Histologic Grading Method.....	440

CID 6072	Breast Implant Findings .....	440
CID 6080	Gynecological Hormones.....	440
CID 6081	Breast Cancer Risk Factors .....	441
CID 6082	Gynecological Procedures .....	442
CID 6083	Procedures for Breast.....	442
CID 6084	Mammoplasty Procedures .....	442
CID 6085	Therapies for Breast .....	443
CID 6086	Menopausal Phase .....	443
CID 6087	General Risk Factors .....	443
CID 6088	OB-GYN Maternal Risk Factors.....	444
CID 6089	Substances .....	445
CID 6090	Relative Usage, Exposure Amount.....	445
CID 6091	Relative Frequency of Event Values.....	446
CID 6092	Quantitative Concepts for Usage, Exposure.....	446
CID 6093	Qualitative Concepts for Usage, Exposure Amount .....	446
CID 6094	Qualitative Concepts for Usage, Exposure Frequency .....	447
CID 6095	Numeric Properties of Procedures.....	447
CID 6096	Pregnancy Status.....	447
CID 6097	Side of Family .....	448
CID 6100	Chest Component Categories.....	448
CID 6101	Chest Finding or Feature .....	448
CID 6102	Chest Finding or Feature Modifier .....	449
CID 6103	Abnormal Lines Finding or Feature.....	449
CID 6104	Abnormal Opacity Finding or Feature.....	450
CID 6105	Abnormal Lucency Finding or Feature.....	450
CID 6106	Abnormal Texture Finding or Feature .....	451
CID 6107	Width Descriptor.....	451
CID 6108	Chest Anatomic Structure Abnormal Distribution .....	452
CID 6109	Radiographic Anatomy Finding or Feature .....	452
CID 6110	Lung Anatomy Finding or Feature .....	453
CID 6111	Bronchovascular Anatomy Finding or Feature .....	453
CID 6112	Pleura Anatomy Finding or Feature.....	453
CID 6113	Mediastinum Anatomy Finding or Feature.....	454
CID 6114	Osseous Anatomy Finding or Feature .....	455
CID 6115	Osseous Anatomy Modifiers.....	455
CID 6116	Muscular Anatomy .....	456
CID 6117	Vascular Anatomy.....	457
CID 6118	Size Descriptor.....	458
CID 6119	Chest Border Shape .....	459
CID 6120	Chest Border Definition.....	459
CID 6121	Chest Orientation Descriptor.....	459
CID 6122	Chest Content Descriptor.....	460
CID 6123	Chest Opacity Descriptor .....	460
CID 6124	Location in Chest .....	460
CID 6125	General Chest Location .....	461
CID 6126	Location in Lung.....	461
CID 6127	Segment Location in Lung .....	461
CID 6128	Chest Distribution Descriptor .....	462
CID 6129	Chest Site Involvement .....	462
CID 6130	Severity Descriptor.....	463
CID 6131	Chest Texture Descriptor .....	463
CID 6132	Chest Calcification Descriptor.....	463
CID 6133	Chest Quantitative Temporal Difference Type.....	464
CID 6134	Chest Qualitative Temporal Difference Type.....	464
CID 6135	Chest Image Quality Finding.....	465
CID 6136	Chest Types of Quality Control Standard .....	465
CID 6137	Types of Chest CAD Analysis.....	466

CID 6138	Chest Non-Lesion Object Type.....	466
CID 6139	Non-Lesion Modifiers .....	467
CID 6140	Calculation Methods .....	467
CID 6141	Attenuation Coefficient Measurements.....	468
CID 6142	Calculated Value .....	468
CID 6143	Response Criteria .....	469
CID 6144	RECIST Response Criteria .....	469
CID 6145	Baseline Category.....	469
CID 6151	Background echotexture .....	469
CID 6152	Orientation.....	470
CID 6153	Lesion boundary .....	470
CID 6154	Echo pattern.....	470
CID 6155	Posterior acoustic features .....	471
CID 6157	Vascularity.....	471
CID 6158	Correlation to Other Findings.....	471
CID 6159	Malignancy Type .....	472
CID 6160	Breast Primary Tumor Assessment from AJCC .....	472
CID 6161	Clinical Regional Lymph Node Assessment for Breast .....	473
CID 6162	Assessment of Metastasis for Breast .....	474
CID 6163	Menstrual Cycle Phase .....	474
CID 6164	Time Intervals.....	474
CID 6165	Breast Linear Measurements.....	475
CID 6166	CAD Geometry Secondary Graphical Representation .....	475
CID 7000	Diagnostic Imaging Report Document Titles .....	476
CID 7001	Diagnostic Imaging Report Headings .....	477
CID 7002	Diagnostic Imaging Report Elements .....	477
CID 7003	Diagnostic Imaging Report Purposes of Reference.....	478
CID 7004	Waveform Purposes of Reference.....	478
CID 7005	Contributing Equipment Purposes of Reference .....	478
CID 7006	SR Document Purposes of Reference.....	479
CID 7007	Signature Purpose .....	479
CID 7008	Media Import .....	479
CID 7010	Key Object Selection Document Title .....	480
CID 7011	Rejected for Quality Reasons .....	480
CID 7012	Best In Set.....	481
CID 7020	Document Titles .....	481
CID 7100	RCS Registration Method Type .....	481
CID 7101	Brain Atlas Fiducials .....	482
CID 7150	Segmentation Property Categories.....	482
CID 7151	Segmentation Property Types .....	482
CID 7152	Cardiac Structure Segmentation Types.....	483
CID 7153	Brain Tissue Segmentation Types.....	484
CID 7154	Abdominal Organ Segmentation Types.....	484
CID 7155	Thoracic Tissue Segmentation Types .....	484
CID 7156	Vascular Tissue Segmentation Types .....	485
CID 7157	Device Segmentation Types.....	485
CID 7158	Artifact Segmentation Types.....	486
CID 7159	Lesion Segmentation Types .....	486
CID 7160	Pelvic Organ Segmentation Types .....	487
CID 7161	Physiology Segmentation Types.....	487
CID 7201	Referenced Image Purposes of Reference .....	488
CID 7202	Source Image Purposes of Reference.....	488
CID 7203	Image Derivation .....	489
CID 7205	Purpose Of Reference to Alternate Representation .....	490
CID 7210	Related Series Purposes Of Reference.....	490
CID 7450	Person Roles.....	491
CID 7451	Family Member .....	491



CID 7452	Organizational Roles.....	492
CID 7453	Performing Roles .....	492
CID 7454	Species .....	493
CID 7455	Sex .....	493
CID 7456	Units of Measure for Age .....	494
CID 7460	Units of Linear Measurement.....	494
CID 7461	Units of Area Measurement .....	494
CID 7462	Units of Volume Measurement.....	495
CID 7470	Linear Measurements .....	495
CID 7471	Area Measurements.....	496
CID 7472	Volume Measurements .....	496
CID 7480	Breed.....	496
CID 7481	Breed Registry .....	549
CID 9231	General Purpose Workitem Definition .....	550
CID 9232	Non-DICOM Output Types.....	550
CID 9300	Procedure Discontinuation Reasons .....	550
CID 10000	Scope of Accumulation .....	551
CID 10001	UID Types .....	551
CID 10002	Irradiation Event Types .....	552
CID 10003	Equipment Plane Identification .....	552
CID 10004	Fluoro Modes .....	552
CID 10006	X-Ray Filter Materials .....	553
CID 10007	X-Ray Filter Types .....	553
CID 10008	Dose Related Distance Measurements .....	553
CID 10009	Measured/Calculated .....	554
CID 10010	Dose Measurement Devices.....	554
CID 12001	Ultrasound Protocol Types.....	554
CID 12002	Ultrasound Protocol Stage Types .....	555
CID 12003	OB-GYN Dates.....	557
CID 12004	Fetal Biometry Ratios.....	557
CID 12005	Fetal Biometry Measurements.....	557
CID 12006	Fetal Long Bones Biometry Measurements.....	558
CID 12007	Fetal Cranium.....	558
CID 12008	OB-GYN Amniotic Sac.....	559
CID 12009	Early Gestation Biometry Measurements .....	559
CID 12011	Ultrasound Pelvis and Uterus .....	559
CID 12012	OB Equations and Tables .....	560
CID 12013	Gestational Age Equations and Tables .....	560
CID 12014	OB Fetal Body Weight Equations and Tables .....	563
CID 12015	Fetal Growth Equations and Tables.....	563
CID 12016	Estimated Fetal Weight Percentile Equations and Tables.....	565
CID 12017	Growth Distribution Rank .....	565
CID 12018	OB-GYN Summary .....	565
CID 12019	OB-GYN Fetus Summary .....	566
CID 12101	Vascular Summary.....	566
CID 12102	Temporal Periods Relating to Procedure or Therapy .....	566
CID 12103	Vascular Ultrasound Anatomic Location .....	567
CID 12104	Extracranial Arteries.....	567
CID 12105	Intracranial Cerebral Vessels.....	568
CID 12106	Intracranial Cerebral Vessels (unilateral).....	568
CID 12107	Upper Extremity Arteries.....	569
CID 12108	Upper Extremity Veins .....	570
CID 12109	Lower Extremity Arteries.....	570
CID 12110	Lower Extremity Veins .....	571
CID 12111	Abdominal Arteries (lateral) .....	571
CID 12112	Abdominal Arteries (unilateral).....	572
CID 12113	Abdominal Veins (lateral).....	572

CID 12114	Abdominal Veins (unilateral).....	573
CID 12115	Renal Vessels .....	573
CID 12116	Vessel Segment Modifiers .....	574
CID 12117	Vessel Branch Modifiers .....	574
CID 12119	Vascular Ultrasound Property .....	575
CID 12120	Blood Velocity Measurements .....	575
CID 12121	Vascular Indices and Ratios .....	575
CID 12122	Other Vascular Properties.....	576
CID 12123	Carotid Ratios .....	576
CID 12124	Renal Ratios.....	577
CID 12140	Pelvic Vasculature Anatomical Location .....	577
CID 12141	Fetal Vasculature Anatomical Location .....	577
CID 12200	Echocardiography Left Ventricle .....	578
CID 12201	Left Ventricle Linear .....	578
CID 12202	Left Ventricle Volume .....	579
CID 12203	Left Ventricle Other .....	579
CID 12204	Echocardiography Right Ventricle.....	579
CID 12205	Echocardiography Left Atrium.....	580
CID 12206	Echocardiography Right Atrium .....	580
CID 12207	Echocardiography Mitral Valve .....	580
CID 12208	Echocardiography Tricuspid Valve .....	581
CID 12209	Echocardiography Pulmonic Valve .....	581
CID 12210	Echocardiography Pulmonary Artery .....	582
CID 12211	Echocardiography Aortic Valve .....	582
CID 12212	Echocardiography Aorta .....	582
CID 12214	Echocardiography Pulmonary Veins.....	583
CID 12215	Echocardiography Vena Cavae .....	583
CID 12216	Echocardiography Hepatic Veins.....	583
CID 12217	Echocardiography Cardiac Shunt .....	584
CID 12218	Echocardiography Congenital.....	584
CID 12219	Pulmonary Vein Modifiers .....	584
CID 12220	Echocardiography Common Measurements .....	584
CID 12221	Flow Direction .....	585
CID 12222	Orifice Flow Properties.....	585
CID 12223	Echocardiography Stroke Volume Origin.....	585
CID 12224	Ultrasound Image Modes.....	586
CID 12226	Echocardiography Image View .....	586
CID 12227	Echocardiography Measurement Method .....	587
CID 12228	Volume Methods .....	587
CID 12229	Area Methods.....	587
CID 12230	Gradient Methods.....	588
CID 12231	Volume Flow Methods .....	588
CID 12232	Myocardium Mass Methods .....	588
CID 12233	Cardiac Phase.....	589
CID 12234	Respiration State.....	589
CID 12235	Mitral Valve Anatomic Sites .....	589
CID 12236	Echo Anatomic Sites.....	589
CID 12237	Echocardiography Anatomic Site Modifiers .....	590
CID 12238	Wall Motion Scoring Schemes .....	590
CID 12239	Cardiac Output Properties .....	590
CID 12240	Left Ventricle Area .....	591
CID 12241	Tricuspid Valve Finding Sites.....	591
CID 12242	Aortic Valve Finding Sites .....	591
CID 12243	Left Ventricle Finding Sites .....	591
CID 12244	Congenital Finding Sites .....	592
Annex C	Acquisition and Protocol Context Templates (Normative).....	593
TEMPLATES	.....	593

TID 3401	ECG Acquisition Context.....	593
TID 3403	Catheterization Acquisition Context .....	593
TID 3450	Cardiac Electrophysiology Acquisition Context.....	593
TID 3470	NM Acquisition Context.....	594
TID 15100	Contrast Agent/Pre-Medication Protocol Context.....	594
TID 15101	NM/PET Protocol Context.....	594
TID 15200	JJ1017 Protocol Context.....	595
Annex D	DICOM Controlled Terminology Definitions (Normative) .....	596
Annex E	French Translations of Selected Codes used in the DCMR (Normative).....	717
Annex F	Japanese Translations of Selected Codes used in the DCMR (Normative) .....	752
Annex G	English Code Meanings of Selected Codes (Normative).....	766
Annex H	Code Meanings of LOINC Codes in DCMR .....	774
Annex I	Relationship of Endoscopy Procedures to Anatomic Regions (Informative).....	784
Annex J	SNOMED DICOM Microglossary Retired Codes (Normative) .....	786
Annex K	Relevant Patient Information Templates (Normative) .....	788

## FOREWORD

The American College of Radiology (ACR) and the National Electrical Manufacturers Association (NEMA) formed a joint committee to develop a standard for Digital Imaging and Communications in Medicine (DICOM). This DICOM Standard was developed according to the NEMA procedures.

This standard is developed in liaison with other standardization organizations including CEN TC251 in Europe, and JIRA and MEDIS-DC in Japan, with review also by other organizations including IEEE, HL7 and ANSI in the USA.

The DICOM Standard is structured as a multi-part document using the guidelines established in the following document:

— ISO/IEC Directives, 1989 Part 3 : Drafting and Presentation of International Standards.

This document is one part of the DICOM Standard, which consists of the following parts:

- PS 3.1: Introduction and Overview
- PS 3.2: Conformance
- PS 3.3: Information Object Definitions
- PS 3.4: Service Class Specifications
- PS 3.5: Data Structures and Encoding
- PS 3.6: Data Dictionary
- PS 3.7: Message Exchange
- PS 3.8: Network Communication Support for Message Exchange
- PS 3.9: Retired
- PS 3.10: Media Storage and File Format for Media Interchange
- PS 3.11: Media Storage Application Profiles
- PS 3.12: Formats and Physical Media
- PS 3.13: Retired
- PS 3.14: Grayscale Standard Display Function
- PS 3.15: Security and System Management Profiles
- PS 3.16: Content Mapping Resource
- PS 3.17: Explanatory Information
- PS 3.18: Web Access to DICOM Persistent Objects (WADO)

These parts are related but independent documents. Their development level and approval status may differ. Additional parts may be added to this multi-part standard. PS 3.1 should be used as the base reference for the current parts of this standard.

## 1 Scope and field of application

This part of the DICOM Standard specifies the DICOM Content Mapping Resource (DCMR) which defines the templates and context groups used elsewhere in the standard.

## 2 Normative references

The following standards contain provisions that, through reference in this text, constitute provisions of this Standard. At the time of publication, the editions indicated were valid. All standards are subject to revision, and parties to agreements based on this Standard are encouraged to investigate the possibilities of applying the most recent editions of the standards indicated below.

- UCUM Unified Code for Units of Measure, Regenstrief Institute for Health Care, Indianapolis 2000.
- LOINC® Logical Observation Identifier Names and Codes, Regenstrief Institute for Health Care, Indianapolis 2000.
- SNOMED® Systematized Nomenclature of Medicine, Version 3, College of American Pathologists
- SNOMED® Systematized Nomenclature of Medicine – RT, College of American Pathologists
- JJ1017 Guidelines for HIS, RIS, PACS – Modality Data Communication on Scheduling, Billing, and Examination Records, JJ1017 Version 3.0, Japan Industries Association of Radiological Systems (JIRA) and Japanese Association of Healthcare Information Systems Industry (JAHIS), 2001October 5, 2005, available from [http://www.jira-net.or.jp/commission/system/04\\_information/files/JJ1017VER3\\_20051005.doc](http://www.jira-net.or.jp/commission/system/04_information/files/JJ1017VER3_20051005.doc)
- RFC 3066 Tags for the Identification of Languages, Internet Engineering Task Force
- ISO 639 Codes for the representation of names of languages, International Organization for Standardization
- ISO 3166 Codes for the representation of names of countries, International Organization for Standardization
- ASTM E 1762-04 Standard Guide for Electronic Authentication of Health Care Information, ASTM International
- ASTM E 2084-00 Standard Specification for Authentication of Healthcare Information Using Digital Signatures, ASTM International

This DICOM Standard incorporates a subset of terms from SNOMED® RT – The Systematized Nomenclature of Medicine Clinical Terms, used by permission of the College of American Pathologists ©1999 College of American Pathologists (CAP). SNOMED is a registered trademark of the College of American Pathologists, all rights reserved.

All the SNOMED terms used in this Standard are the subject of a royalty pre-paid licensing agreement between NEMA and CAP that allows their use in DICOM applications without further license or payment of fee.

### BI-RADS® Terminology and Nomenclature

A portion of the terminology used within the Mammography CAD SR SOP Class and the Breast Imaging Report and Relevant Patient Information for Breast Imaging templates is derived from BI-RADS®, a copyrighted lexicon of breast imaging terminology and nomenclature licensed by DICOM from the American College of Radiology. BI-RADS® publications are available from the American College of Radiology (<http://www.acr.org>).

### **MQCM 1999 Terminology and Nomenclature**

References to MQCM 1999 are made in the description of the Mammography CAD SR SOP Class. In this MQCM 1999 refers to the Mammography Quality Control Manual 1999, available from the American College of Radiology. This document describes a standardized approach to mammographic acquisition standards, patient positioning, and so on. The DICOM standard does not require Mammography CAD SR SOP Class implementations to adhere to MQCM 1999.

### **MQSA Terminology and Nomenclature**

References to MQSA are made in the description of the Mammography CAD SR SOP Class. In this MQSA refers to the Mammography Quality Standards Act final rules. While MQSA is a federal regulation of the United States government, it provides the only widely published standards for mammographic quality and is incorporated in this document for that reason. The DICOM standard does not require Mammography CAD SR SOP Class implementations to adhere to MQSA.

### **ACR Position Statement**

American College of Radiology. ACR Position Statement. In: Standards. Reston, Va: 2001:iv.

### **Fraser and Pare Terminology**

References to [Fraser and Pare] are made in the description of the Chest CAD SR templates and context groups. Specifically, these references are to the “Terms Used in Chest Radiology” and “Terms For CT of the Lungs”, from Fraser and Pare’s Diagnosis of Diseases of the Chest, Fourth Edition, Volume I, pp. xvii-xxxi and pp. xxxiii-xxxvi, respectively.

### **Performance of CT for Detection of Pulmonary Embolism in Adults**

American College of Radiology. ACR Standard for the Performance of Computed Tomography for the Detection of Pulmonary Embolism in Adults. In: Standards. Reston, Va: 2001:109-113.

### **Performance of High-Resolution CT of the Lungs in Adults**

American College of Radiology. ACR Standard for the Performance of High-Resolution Computed Tomography (HRCT) of the Lungs in Adults. In: Standards. Reston, Va: 2001:115-118.

### **Performance of Pediatric and Adult Chest Radiography, ACR**

American College of Radiology. ACR Standard for the Performance of Pediatric and Adult Chest Radiography. In: Standards. Reston, Va: 2001:95-98.

### **Performance of Pediatric and Adult Thoracic CT**

American College of Radiology. ACR Standard for the Performance of Pediatric and Adult Thoracic Computed Tomography (CT). In: Standards. Reston, Va: 2001:103-107.

### **RECIST**

References to the Response Evaluation Criteria In Solid Tumors are made from the Chest CAD SR templates and context groups. These references are based on the article “New Guidelines to Evaluate the Response to Treatment in Solid Tumors”, by Patrick Therasse et.al., Journal of the National Cancer Institute, Vol. 92, No. 3, February 2, 2000, pp. 205-216. See also <http://www.eortc.be/recist/>.

## WHO

WHO Handbook for Reporting Results for Cancer Treatment, World Health Organization, Geneva, 1979, WHO Offset Publication No. 48. See also <http://whqlibdoc.who.int/publications/9241700483.pdf>.

## Myocardial Segmentation

Manuel D. Cerqueira, et al., "Standardized Myocardial Segmentation and Nomenclature for Tomographic Imaging of the Heart", 2001. See "<http://www.asecho.org/freepdf/CardiacSegmentation.pdf>".

## Quantitation of the Left Ventricle

*Recommendations for Quantitation of the Left Ventricle by Two-Dimensional Echocardiography*, Journal of the American Society of Echocardiography, Vol 2, No 5 358-367, Oct 1989.

## AJCC

American Joint Committee on Cancer (AJCC) Cancer Staging Handbook, from the AJCC Cancer Staging Manual, Sixth Edition, Springer-Verlag, 2002 [ISBN 0-387-95270-5].

## Quantitative Arteriography and Ventriculography

- [Sheehan, 1986] Sheehan FH, Bolson EL, Dodge HT, Mathey DG, Schofer J, Woo HW (1986) Advantages and applications of the centerline method for characterizing regional ventricular function. *Circulation* 74:293-305
- [Slager] Slager CJ, Hooghoudt TE, Serruys PW, Schuurbiens JC, Reiber JH, Meester GT, Verdouw PD, Hugenholtz PG. Quantitative assessment of regional left ventricular motion using endocardial landmarks. *J Am Coll Cardiol*. 1986;7:317-26.
- [Kennedy, 1970] Kennedy JW, Trenholme SE, Kasser IS (1970) Left ventricular volume and mass from single-plane cineangiogram. A comparison of anteroposterior and right anterior oblique methods. *Am Heart J* 80:343
- [Dodge, 1960] Dodge HT, Sandler H, Ballew DW, Lord JD (1960) The use of biplane angiography for the measurement of left ventricular volume in man. *Am Heart J* 60:762
- [Wynne] Wynne J, Green LH, Mann T, Levin D, Grossman W (1978) Estimation of left ventricular volumes in man from biplane cineangiograms filmed in oblique projections. *Am J Cardiol* 41: 726
- [Boak] Boak, J. G., Bove, A. A., Kreulen, T. & Spann, J. F. A geometric basis for calculation of right ventricular volume in man. *Cathet Cardiovasc Diagn* 3, 217-30, 1977.
- [Ferlinz] Ferlinz, J. Measurements of right ventricular volumes in man from single plane cineangiograms. A comparison to the biplane approach. *Am Heart J* 94, 87-90, 1977.
- [Graham] Graham, T. P., Jr., Jarmakani, J. M., Atwood, G. F. & Canent, R. V., Jr. Right ventricular volume determinations in children. Normal values and observations with volume or pressure overload. *Circulation* 47, 144-53, 1973.
- [Arcilla] Arcilla RA, Tsai P, Thilenius O, Ranniger K (1971) Angiographic method for volume estimation of right and left ventricles. *Chest* 60:446

## IVUS



“American College of Cardiology Clinical Expert Consensus Document on Standards for Acquisition, Measurement and Reporting of Intravascular Ultrasound Studies (IVUS)” - Journal of the American College of Cardiology - Vol. 37, No. 5, 2001. ISSN 0735-1097.

“Clinical Application and Image Interpretation in Intravascular Ultrasound”, edited by the Working Group of Coronary Circulation (now Interventional Cardiology) and Subgroup on Intravascular Ultrasound of the Working Group of Echocardiography of the European Society of Cardiology – European Heart Journal Vol 19, 1998, pages 207-229

Tobis & Yock, Intravascular Ultrasound Imaging, 1992. ISBN: 0443088098

### 3 Definitions

For the purposes of this Standard the following definitions apply.

#### 3.1 CODES AND CONTROLLED TERMINOLOGY DEFINITIONS:

The following definitions are commonly used in this Part of the DICOM Standard:

- 3.1.1 Baseline Context Group Identifier (BCID):** Identifier that specifies the suggested Context Group for a Code Sequence Attribute.
- 3.1.2 Defined Context Group Identifier (DCID):** Identifier that specifies the Context Group for a Code Sequence Attribute that shall be used.
- 3.1.3 Extensible Context Group:** Context Group that may be extended by a particular application by inclusion of additional concepts.
- 3.1.4 Non-Extensible Context Group:** Context Group whose defined set of concepts shall not be extended by an application.
- 3.1.5 Context Group:** A set of coded concepts defined by a Mapping Resource forming a set appropriate to use in a particular context.
- 3.1.6 Context Group Version:** Version of a Context Group.
- 3.1.7 Context ID (CID):** Identifier of a Context Group.
- 3.1.8 Mapping Resource:** A resource that defines context-dependent usage constraints (i.e. Value Set or Relationship Type restrictions) for Attributes. A resource that specifies the mapping of the content of an external controlled terminology to the components of a message standard.
- 3.1.9 Relationship Type:** The association between two Concepts. Examples: “HAS PROPERTIES”, “CONTAINS”, “INFERRED FROM”.
- 3.1.10 DICOM Content Mapping Resource (DCMR):** A Mapping Resource that defines Templates and Context Groups for use in DICOM IODs.
- 3.1.11 Template:** A pattern that describes the Content Items, Value Types, Relationship Types and Value Sets that may be used in part of a Structured Report content tree, or in other Content Item constructs, such as Acquisition Context or Protocol Context. Analogous to a Module of an Information Object Definition.
- 3.1.12 Template ID (TID):** Identifier of a Template.
- 3.1.13 Value Set:** The allowed values of a Code Sequence Attribute in a given context. Specified either as one or more individual values or by reference to a Context Group.

- 3.1.14 Baseline Template Identifier (BTID):** Identifier that specifies a template suggested to be used in the creation of a set of Content Items.
- 3.1.15 Defined Template Identifier (DTID):** Identifier that specifies a template that shall be used in the creation of a set of Content Items.
- 3.1.16 Extensible Template:** A template that may be extended by a particular application by inclusion of additional Content Items beyond those specified in the template.
- 3.1.17 Non-Extensible Template:** A template that specifies the exact set of Content Items and corresponding Value Sets that shall be used and which shall not be extended by an application.
- 3.1.18 Coding schemes:** Dictionaries (lexicons) of concepts (terms) with assigned codes and well defined meanings.

Note: Examples of coding schemes include SNOMED and LOINC.

### 3.2 INFORMATION OBJECT DEFINITIONS:

This Part of the Standard makes use of the following terms defined in PS 3.3:

- Code Sequence Attribute

## 4 Symbols and abbreviations

The following symbols and abbreviations are used in this Part of the Standard.

<b>Mammography CAD</b>	Computer-Aided Detection and/or Computer-Aided Diagnosis for Mammography
<b>Chest CAD</b>	Computer-Aided Detection and/or Computer-Aided Diagnosis for chest radiography
<b>ACR</b>	American College of Radiology
<b>ASE</b>	American Society of Echocardiography
<b>CAP</b>	College of American Pathologists
<b>DCMR</b>	DICOM Content Mapping Resource
<b>NEMA</b>	National Electrical Manufacturers Association
<b>RECIST</b>	Response Evaluation Criteria In Solid Tumors
<b>SNOMED</b>	Systematized Nomenclature of Medicine
<b>UCUM</b>	Unified Code for Units of Measure
<b>WHO</b>	World Health Organization
<b>EV</b>	Enumerated Value
<b>DT</b>	Defined Term
<b>CNAME</b>	Context Group Name
<b>TNAME</b>	Template Name
<b>BCID</b>	Baseline Context Group ID
<b>DCID</b>	Defined Context Group ID

<b>ECID</b>	Enumerated Context Group ID
<b>BTID</b>	Baseline Template ID
<b>DTID</b>	Defined Template ID
<b>ETID</b>	Enumerated Template ID

The following upper-case abbreviations represent specific Attributes:

<b>CV</b>	Code Value (0008,0100)
<b>CSD</b>	Coding Scheme Designator (0008,0102)
<b>CM</b>	Code Meaning (0008,0104)
<b>CSV</b>	Coding Scheme Version (0008,0103)

## 5 Conventions

Terms listed in Section 3 Definitions are capitalized throughout the document.

## 6 Form of Template Specifications

Templates are patterns that specify the Concept Names, Requirements, Conditions, Value Types, Value Multiplicity, Value Set restrictions, Relationship Types and other attributes of Content Items for a particular application.

An IOD may specify that particular Standard Templates shall be used or may be used to define or constrain the content of a Content Item construct. A Content Item construct includes a coded concept name and one of several types of coded values. Content Item constructs are used in:

- the main Data Set and recursively nested Content Sequences (0040,A730) of the SR Document Content Module
- the Acquisition Context Sequence(0040,0555) of the Acquisition Context Module,
- the Protocol Context Sequence (0040,0440) and Content Item Modifier Sequence (0040,0441) of the Scheduled Procedure Step Module, Image Acquisition Results Module, and others.

Annexes A and C of this Part define Standard Templates.

Note: Standard Extended and Private Templates may be defined by implementors of the Standard. The rules for definition of Standard Extended and Private SR Templates are similar to the rules for definition of Standard Extended and Private SOP Classes. One row of a Template definition table corresponds to one row of a Module table.

Each Standard Template is specified by a Template table in this Part. Each Template table specifies exactly one Template, corresponding to a pattern of content within a Content Item construct.

The range of concepts and the options that are permitted in a family of SR Documents vary inversely with the level of constraint that is applied by the corresponding SR Template. The more narrow the range of concepts and the more restricted the options permitted by a Template, the more predictable the content of the SR Documents will be.

- Notes:
1. A very specific Template defines a family of SR Documents that are very similar to each other. They have a narrow range of content options (e.g. high level of constraint of Content Item values; use of CODE or NUM with Enumerated Context Groups) and their content is therefore highly predictable. A very general (e.g. permissive or broad) Template defines a family of SR Documents that may differ considerably from one another. They have a broader range of content options (e.g. low level of constraint of Content Item values; use of TEXT and relatively little restriction of Content Item values) and their content is less predictable.
  2. The degree of interoperability that may be achieved with a family of SR Documents generated from a Template may be determined intentionally and precisely at a desired level by appropriate Template design to achieve the necessary degree of predictability of SR Document contents.

### 6.1 TEMPLATE TABLE FIELD DEFINITION

SR Templates are described using tables of the following form:

**TID #**  
**Template Name**  
**Type: (Non-)Extensible**

NL	Rel with Parent	VT	Concept Name	VM	Req Type	Condition	Value Set Constraint
1							
2							
3							

Acquisition Context Templates are described using tables of the following form:

**TID #**  
**Template Name**  
**Type: (Non-)Extensible**

	VT	Concept Name	VM	Req Type	Condition	Value Set Constraint
1						
2						
3						

Protocol Context Templates are described using tables of the following form:

**TID #**  
**Template Name**  
**Type: (Non-)Extensible**

	NL	VT	Concept Name	VM	Req Type	Condition	Value Set Constraint
1							
2							
3							

The semantics of the fields (columns) of Template tables are defined by subsections of this Section. A row of a Template table specifies either one Content Item or inclusion of another Template that may specify any number of Content Items (see Section 6.2.3 for definition of Included Templates). Each

Template table is named by a title, identified by a TID number and further explained by a description such as explanation of Template contents, purpose and use cases.

The following conventions are defined for the form of references to coded concepts, Context Groups and Templates.

Code Meanings are enclosed in quotation marks (for example "cm"). Code Values and Coding Scheme Designators are not enclosed in quotation marks unless a comma occurs in the string.

References to coded concepts take the following form:

EV or DT (CV, CSD, "CM")

e.g. an Enumerated Value with only CV, CSD, and CM defined is represented as follows:  
EV (CV, CSD, "CM"), for example EV (T-04000, SNM3, "Breast").

MemberOf { BCID or DCID (CID) CNAME } MemberOf selects one term from the specified context group.

If reference to a specific coding scheme version is required, it takes the following form:

EV or DT (CV, CSD [CSV], "CM")

e.g., DT (D3-81922, SRT [V1], "Aortic fistula").

References to Context Groups take the following form:

BCID or DCID (CID) CNAME

e.g. Defined Context Group 5000 is represented as follows: DCID (5000) Language.

References to Templates take the following form:

BTID or DTID (TID) TNAME

e.g. Baseline Template 1000 is represented as follows: BTID (1000) Quotation.

### 6.1.1 Row Number

Each row of a Template Table is denoted by a row number. The first row is numbered 1 and subsequent rows are numbered in ascending order with increments of 1. This number denotes a row for convenient description as well as reference in conditions. The Row Number of a Content Item in a Template may or may not be the same as the ordinal position of the corresponding Sequence Item (representing the Content Item) in a Content Sequence (0040,A730), depending on the number of times the Content Item is repeated.

The Content Item specified in the first row of a Template table may be of any Value Type. Specifically, it is not constrained to be a CONTAINER.

### 6.1.2 Nesting Level (NL)

The nesting level of Content Items is denoted by ">" symbols, one per level of nesting below the initial Source Content Item (of the Template) in a manner similar to the depiction of nested Sequences of Items in Modules Tables in PS 3.3. When it is necessary to specify the Target Content Item(s) of a relationship, they are specified in the row(s) immediately following the corresponding Source Content Item. The Nesting Level of a Target Content Item is one greater than the Nesting Level of the corresponding (parent) Source Content Item. The Content Item specified in row 1 of a Template Table is at the top level (i.e. no ">" symbol is ever present in the NL field for the first Content Item in the table).

Acquisition context templates have no Nesting Level field. Protocol Context templates allow a single Nesting Level implemented through the Content Item Modifier Sequence (see PS3.3).

**6.1.3 Relationship with Source Content Item (Parent)**

Relationship Type and Relationship Mode (i.e. By-value or By-reference) constraints, if defined, are specified in this field, as described in Table 6.1.3-1.

Relationship Type and Mode are specified for each row that specifies a target content item.

Relationship Type and Mode may also be specified when another Template is included, either “top-down” or “bottom-up” or both (i.e. in the “INCLUDE Template” row of the calling Template, or in all rows of the included Template, or in both places). There shall be no conflict between the Relationship Type and Mode of a row that includes another Template and the Relationship Type and Mode of the rows of the included Template.

Note: SR IODs specify Enumerated Values for Relationship Types. If a Relationship Type other than one of the Defined Terms for Relationship Type (0040,A010) is specified in a Private SOP Class, there is a significant risk to interoperability. Documentation accompanying Templates for Private SOP Classes should define any Relationship-type extensions in the manner that the Standard Relationship Types are defined in PS 3.3.

Acquisition context and Protocol Context templates have no Relationship field.

**Table 6.1.3-1  
Syntax of Relationship Constraints**

Expression	Definition
RTYPE	Relationship Mode is By-value and Relationship Type is RTYPE. For example, “INFERRED FROM”.
R-RTYPE	Relationship Mode is By-reference and Relationship Type is RTYPE. For example, “R-INFERRED FROM”.

**6.1.4 Value Type (VT)**

The Value Type field specifies the SR Value Type of the Content Item or conveys the word “INCLUDE” to indicate that another Template is to be included (substituted for the row). See Section 6.2.3 for further description of “Included Templates”.

**6.1.5 Concept Name**

Any constraints on Concept Name are specified in this field as defined or enumerated coded entries, or as baseline or defined context groups. Alternatively, when the VT field is “INCLUDE”, the Concept Name field specifies the template to be included.

**6.1.6 Value Multiplicity (VM)**

The VM field indicates the number of times that either a Content Item of the specified pattern or an included Template may appear in this position. Table 6.1.6-1 specifies the values that are permitted in this field.

**Table 6.1.6-1  
Permitted Values for VM**

Expression	Definition
i (where ‘i’ represents an integer)	Exactly i occurrences, where $i \geq 1$ . E.g. when $i=1$ there shall be one occurrence of the Content Item in this position.
i-j	From i to j occurrences, where i and j are $\geq 1$ and $j > i$ .

1-n	One or more occurrences
-----	-------------------------

### 6.1.7 Requirement Type

The Requirement Type field specifies the requirements on the presence or absence of the Content Item or included Template.

Note: There is typically no need to specify Requirement Type separately for SCU and SCP of the Basic SR SOP Classes, because the SCP is required to support the entire content of any SR Document it receives. Therefore, for Basic SR SOP Classes, Requirement Type effectively only applies to the SCU.

The following symbols are used:

M – Mandatory. Shall be present.

MC – Mandatory Conditional. Shall be present if the specified condition is satisfied.

U – User Option. May or may not be present.

UC – User Option Conditional. May not be present. May be present according to the specified condition.

Note: There is an interaction between the VM and the Requirement Type with respect to the number of times that a content item (or included Template) may actually be present, as follows:

Req Type	VM	Actual number of occurrences in the content tree
M	1	1
M	1-n	1 to n
U	1	0 or 1
U	1-n	0 to n

### 6.1.8 Condition

The Condition field specifies any conditions upon which presence or absence of the Content Item or its values depends. This field specifies any Concept Name(s) or Values upon which there are dependencies.

References in Condition statements to coded concepts or values, whether to select a content item to test or to specify a value to test against, are of the form (CV, CSD, "CM"). As is always the case for coded entries, the matching is performed against CV and CSD, irrespective of the string value of CM.

References may also be made to row numbers (e.g. to specify exclusive OR conditions that span multiple rows of a Template table).

The following abbreviations are used:

XOR = Exclusive OR. One and only one row shall be selected from mutually-exclusive options.

Note: For example, if one of rows 1, 2, 3 or 4 may be included, then for row 2, the abbreviation "XOR rows 1,3,4" is specified for the condition.

IF = Shall be present if the condition is TRUE; may be present otherwise.

IFF = If and only if . Shall be present if the condition is TRUE; shall not be present otherwise.

### 6.1.9 Value Set Constraint

Value Set Constraints, if any, are specified in this field as defined or enumerated coded entries, or as baseline or defined context groups.

The Value Set Constraint column may specify a default value for the Content Item if the Content Item is not present, either as a fixed value, or by reference to another Content Item, or by reference to an Attribute from the dataset other than within the Content Sequence (0040,A730).

#### **6.1.9.1 NUM Units Constraint**

Constraints on units of measurement, if any, are specified in the Value Set Constraint field if and only if the Value Type is NUM. The constraints are specified either as defined or enumerated coded entries, or as baseline or defined context groups.

#### **6.1.9.2 CONTAINER Continuation Flag Constraint**

The value of the Continuity of Content Flag (0040,A050) may be specified in the Value Set Constraint field if and only if the Value Type is CONTAINER.

Note: The SR Document Content Module specifies "SEPARATE" and "CONTINUOUS" as the Enumerated Values for Continuity of Content Flag (0040,A050).

#### **6.1.9.3 SCOOD Graphic Type Constraint**

Constraints on the value of the Graphic Type (0070,0023) may be specified in the Value Set Constraint field if and only if the Value Type is SCOOD. The constraint may specify a set of allowed values, or a set of disallowed values. For example:

GRAPHIC TYPE = {POINT}

GRAPHIC TYPE = {CIRCLE, ELLIPSE}

GRAPHIC TYPE = not {MULTIPOINT}

### **6.2 SPECIAL CONVENTIONS FOR TEMPLATE TABLES**

#### **6.2.1 Multiple Value Sets Depending on Different Conditions**

When a Content Item may have different value sets, each depending on different conditions, the description of each different case begins in a separate row of the Template Table.

#### **6.2.2 Target Content Items of Relationships**

When it is necessary to specify the Target Content Item(s) of a relationship, they are specified in the row(s) immediately following the Source Content Item. The Nesting level of a Target Content Item (or set of Target Content Items specified indirectly via an 'include Template' macro) is one greater than the Nesting Level of the corresponding Source Content Item, as indicated by an increase in the number of ">" characters in the nesting level.

When a Content Item may be the Source of multiple relationships having different Relationship Types and/or different Relationship Modes and/or different patterns of Target Content Item(s), the description of each different case begins in a separate row of the Template Table.

When the Source Content Item of a relationship has VM of greater than 1, the specified pattern of Target Content Items applies to all instantiations of the Source Content Item.

Note: For example, if a Template specifies that the VM of a Source Content Item is 1-n and specifies a By-value relationship to two CODE Content Items with particular value set constraints, then each instantiation of the Source Content Item has a By-value relationship to two CODE Content Items with the specified value constraints.

When a Source Content Item that has a Requirement Type of U, UC or MC is not present (is not instantiated), no Target Content Items of that Source Content Item are present, even if one or more of the Target Content Items is designated with a Requirement Type of M or MC.

Note: In otherwords, potential children are not present when there is no parent.



### 6.2.3 Inclusion of Templates

A Template may specify another Template to be included by specifying "INCLUDE" in the Value Type field and the identifier of the included Template in the Concept Name field. All of the rows of the specified Template are included in the invoking Template, effectively substituting the specified template for the row where the inclusion is invoked. Whether or not the inclusion is user optional, mandatory or conditional is specified in the Requirement and Condition fields. The number of times the included Template may be repeated is specified in the VM field.

#### 6.2.3.1 Template Parameters

A Template that is included by another Template may include parameters that are replaced by values defined in the invoking Template. Parameters may be used to specify coded concepts or Context Groups in the Concept Name, Condition, or Value Set Constraint fields of a Template.

An included Template that accepts parameters shall be introduced by a table listing those parameters of the form:

Parameter Name	Parameter Usage

Parameters are indicated by a name beginning with the character "\$".

The invoking Template may specify the value of the parameters in the included Template by name in the Value Set Constraint field of the INCLUDE row. The parameter in the included Template shall be replaced by the specified parameter value. Specification of a parameter value shall be of one of the following forms:

Notation	Definition
\$parametername = EV or DT (CV, CSD, "CM")	The parameter passed to the template is the specified coded term.
\$parametername = (CV, CSD, "CM")	The parameter passed to the template is the specified coded term, used as a parameter in a Condition field of the included Template.
\$parametername = BCID or DCID (CID) CNAME	The parameter passed to the template is the Context Group.
\$parametername = MemberOf {BCID or DCID (CID) CNAME}	The parameter passed to the template is a single coded term from the Context Group in curly braces.

The specification of a parameter value is valid only for the directly included template. Therefore, it needs to be explicitly respecified in templates intermediate between the originally specifying Template and the target Template. The intermediate Template may use the same parameter name as used by the Template it invokes; in such a case, the intermediate Template would invoke the subsidiary Template with a specification in the Value Set Constraint field such as:

\$parametername = \$parametername

Note: In this case, the left hand instance of \$parametername is the name in the subsidiary template, and the right hand instance is the (parameterized) value passed into the current template.

The invoking template is not required to specify all parameters of included templates. If not specified, the value set (term or context group) for that parameter is unconstrained. An unconstrained value in a Condition will cause the condition to fail.

#### 6.2.4 Post-coordinated Codes and Has Concept Modifier Relationship

Though it may not be explicitly shown in a particular Template, the use of any coded Concept Name in any Content Item may be defined in a post-coordinated rather than pre-coordinated manner, unless explicitly forbidden by the IOD or the Template.

Accordingly, any such Content Item may have any number of Target Content Items via a "HAS CONCEPT MOD" relationship, even if not explicitly specified in a Template. Each Target Content Item of such a relationship may be more complicated than a single Content Item if the IOD permits (i.e. the post-coordinated concept may potentially be defined by a complex sub-tree).

#### 6.2.5 Extension of Templates

An Extensible Template may be extended in an Application generating SOP Instances to include additional Content Items in its definition. Such Content Items shall not duplicate concepts for which an encoding is defined in the Template. I.e., if a method is provided for the encoding of a concept in the Template, that concept shall not be encoded using a different Content Item in an extension to the Template.

A Non-extensible Template shall not be modified in an Application by the addition of Content Items to its definition.

Notes: The set of Content Items in either an Extensible or a Non-extensible Template may be changed in subsequent editions of the Standard, in accordance with the procedures of the DICOM Standards Committee.

A Non-Extensible Template may include a Template that is Extensible. In invoking such a Template, the content structure of SOP Instances created from the Non-Extensible Template may vary according to the varying content structure allowed by the extension of the included Template.

Note: Specification of such extensible content in a Non-Extensible Template may be desirable if the Template defines, e.g., a fixed top level structure into which a variety of lower level structures may be "plugged".

## 7 DCMR Context Group Specifications

Context Groups specify Value Set restrictions for Code Value (0008,0100) and Code Meaning (0008,0104) of Code Sequence Attributes for given functional or operational contexts. This Section specifies the semantics of DCMR Context Group Tables.

### 7.1 CONTEXT GROUP TABLE FIELD DEFINITION

Context Groups are described using tables of the following form (optional columns are shown with italic column titles):

<u>Context ID &lt;#&gt;</u>				
<u>&lt;Context Group Name&gt;</u>				
<u>Type: (Non-)Extensible</u>			<u>Version: &lt;yyyymmdd&gt;</u>	
<b>Coding Scheme Designator</b>	<i>Coding Scheme Version</i>	<b>Code Value</b>	<b>Code Meaning</b>	<i>&lt;Reference Terminology&gt; Equivalent Value</i>

<b>Coding Scheme Designator</b>	<b>Coding Scheme Version</b>	<b>Code Value</b>	<b>Code Meaning</b>	<b>&lt;Reference Terminology&gt; Equivalent Value</b>

A row of a Context Group table specifies one coded concept. Each Context Group table is named by a title and identified by a CID number and version.

The columns of the tables consist of:

- Coding Scheme Designator (0008,0102)
- Code Value (0008,0100)
- Code Meaning (0008,0104)

In those cases where it is necessary, Coding Scheme Version (0008,0103) may also be specified. This column may be absent if Coding Scheme Version is not required for any of the coded concepts in the Context Group.

The value specified in the Code Meaning field is an acceptable value for the specified code value, but does not preclude the use of other synonymous text in the same or other language.

Note: Some coding schemes such as LOINC do not specify the equivalent of a Code Meaning.

If further description of the concept represented by the code is required in the DCMR (rather than referring to an external coding scheme), it is included in a separate table.

An optional column may provide an informative mapping from the coded concepts of the Context Group to a reference terminology specified in the column heading.

A Context Group may alternatively be defined by narrative reference to an externally defined coding scheme.

Note: See for instance CID 82.

## 7.2 SPECIAL CONVENTIONS FOR CONTEXT GROUP TABLES

### 7.2.1 Include Context Group

The 'Include Context Group' macro is a concise mechanism for including (by-reference) all of the rows of a specified Context Group in the invoking Context Group, effectively substituting the specified Context Group for the row where the macro is invoked. If an 'Include Context Group' is specified, it shall be specified in the Concept Name column of a Context Group Table. Table 7.2.1-1 specifies the syntax of the 'Include Context Group' macro.

**Table 7.2.1-1  
Include Context Group Macro**

<b>Coding Scheme Designator (0008,0102)</b>	<b>Code Value (0008,0100)</b>	<b>Code Meaning (0008,0104)</b>
...	...	...
<i>Include CID nnn</i>		
...	...	...

### 7.2.2 Units Of Measurement

Context Group 82 is defined to include all units of measurement relevant to DICOM IODs. In the past it was envisaged that an extensible list of pre-coordinated codes would be included in the mapping resource.

DICOM has now adopted the Unified Codes for Units of Measurement (UCUM) standard for all units of measurement. This coding scheme allows for the “construction” of pre-coordinated codes from atomic components.

The specialization of the UCUM standard as it is used in DICOM involves the following rules:

- the Coding Scheme Designator is specified as “UCUM”
- the version of UCUM from which a code is constructed is specified in Coding Scheme Version
- the Code Value will be constructed from UCUM and make use of the “case-sensitive” form of UCUM code (e.g. “ml/s”)
- the Code Meaning for other than UCUM unity may be one of three classes of synonyms:
  - the same string as sent in the Code Value when an abbreviation is required (e.g. “ml/s”)
  - constructed from the “names” of individual components using the Americanized form of name (e.g. “milliliters/second”)
  - constructed from the “names” of individual components using the European form of name (e.g. “millilitres/second”)
- In the case of UCUM unity (“1”, or curly bracket expression) it is forbidden to use “1” as a Code Meaning. Annex G provides Code Meanings for a Code Value (0008,0100) of 1. A Template or Context Group may constrain the Code Meaning according to the following rules:
  - UCUM default unit 1 shall use one of the Code Meaning synonyms specified in Annex G
  - ratios of identically dimensioned values may use ({ratio}, UCUM, “ratio“)
  - unitless numeric scores may use ({M:N}, UCUM, “range: M:N”) to specify the minimum and maximum value, for example, ({0:10}, UCUM, “range: 0:10”)
  - counts using UCUM annotation shall always use the text within the curly braces as the Code Meaning, for example, ({masses}, UCUM, “masses”)

### 7.2.3 Extension of Context Groups

An Application may extend an Extensible Context Group by adding terms for new concepts. Applications may not substitute other terms of the same concept in the Context Group. Such extension may be made without a change in Context Group Identifier, but with the specification of Code Set Extension (see PS3.3).

Non-extensible Context Groups shall not be modified in an Application.

Note: The set of concepts in either an Extensible or a Non-extensible Context Group may be changed in subsequent editions of the Standard, in accordance with the procedures of the DICOM Standards Committee.

## 8 Coding Schemes

Table 8-1 list the coding schemes (and their designators) that have been used in HL7, ASTM and DICOM.

- Notes:
1. An earlier version of this table was formerly contained in Annex D of PS 3.3.
  2. See PS3.3 “Coding Scheme Designator and Coding Scheme Version” for further description.
  3. The Coding Scheme UIDs are provided for reference only; the normative specification of UIDs and their associated meaning is the responsibility of the coding scheme developer and/or HL7.
  4. The HL7 registration of Coding Schemes is available at <http://hl7.org/oid/codingsystems.pdf>.
  5. Use of some Coding Schemes may require a license.

**Table 8-1 Coding Schemes**

Coding Scheme Designator	Coding Scheme UID	Description
ACR		ACR Index for Radiological Diagnosis Revised, 3 <sup>rd</sup> Edition 1986
AS4		American Society for Testing & Materials and CPT4 (see Appendix A of ASTM E1238 and its codes revisions).
ASTM-sigpurpose	1.2.840.10065.1.12	ASTM E 2084 Signature Purpose codes (see Annex A1 of ASTM E 2084), ASTM Subcommittee E 31.20 Data and System Security for Health Information
ART		WHO Adverse Reaction terms
ATC		American Type Culture Collection
BARI		Bypass Angiography Revascularization Investigation, Alderman, EL and Stadius, M, Coronary Artery Disease 1992,3:1189-1207; endorsed by ACC/AHA Guidelines for Coronary Angiography, J Am Coll Cardiol 1999,33:1791
BI		ACR Breast Imaging Reporting and Data System (BI-RADS®BI-RADS® ), Coding Scheme Version (0008,0103) is required; code values are section and paragraph identifiers within the publication where the code meaning is defined (e.g., “I.D.1”, where I = Breast Imaging Lexicon, D = Special Cases, 1 = Tubular Density, as the code value for “Tubular Density”).
C4	2.16.840.1.113883.6.12	American Medical Association’s Current Procedure Terminology 4 (CPT-4)
C5	2.16.840.1.113883.6.82	American Medical Association’s Current Procedure Terminology 5 (CPT-5)
CD2	2.16.840.1.113883.6.13	American Dental Association’s (ADA) Current Dental Terminology 2 (CDT-2)
CDCA		CDC Analyte Codes
CDCM		CDC Methods/Instruments Codes
CDS		CDC Surveillance Codes
CST		COSTART coding system for adverse drug reactions
CVX		CDC Vaccine Codes
CAS		Chemical abstract codes – United States Pharmacopeial Convention
CE		CEN PT007 ECG Diagnostic Codes.

DCL		DICOM – never used
DCM	1.2.840.10008.2.16.4	DICOM Controlled Terminology; PS 3.16 Content Mapping Resource, Annex D
DCMUID	1.2.840.10008.2.6.1	DICOM UID Registry
DQL		DICOM – never used
E		Euclides AFP Codes
E5		Euclides kind of quantity codes
E6		Euclides Lab method codes
E7		Euclides Lab equipment codes
ENZC		Enzyme Codes
FDDC		First DataBank Drug Codes
FDDX		First DataBank Diagnostic Codes
FDK		FDA K10 (device & analyte process codes).
HB		Health Industry Business Communications Council (HIBCC)
HHC		Home Health Care Classification System
HI		Health Outcomes Institute codes for outcome variables
HPC	2.16.840.1.113883.6.14	Healthcare Financing Administration (HCFA) Common Procedure Coding System (HCPCS)
I10	2.16.840.1.113883.6.3	International Classification of Diseases revision 10 (ICD-10)
I10P	2.16.840.1.113883.6.4	ICD-10 Procedure Coding System (ICD 10 PCS)
I9	2.16.840.1.113883.6.42	International Classification of Diseases revision 9 (ICD-9)
I9C	2.16.840.1.113883.6.2	International Classification of Diseases revision 9, with Clinical Modifications (ICD-9-CM)
IBT		International Society of Blood Transfusion (ISBT). Blood Group Terminology “1990”
IC2		International Classification of Health Problems in Primary Care (ICHPPC-2)
ICS		ICCS
IUPC		IUPAC component (analyte) codes
IUPP		IUPAC property codes
ISO639_1		Two-letter language codes
ISO639_2		Three-letter language codes
ISO3166_1	2.16.1	ISO 3166-1 alpha-2_Country Codes
ISO5218_1		Representation of Human Sexes (not used – see note)
IUC		IUPAC/IFCC Recommendations of Quantities and Units in Clinical Chemistry
JC8		Japanese Chemistry Clinical examination classification code. Japan Association of Clinical Pathology. Version 8, 1990.
LN	2.16.840.1.113883.6.1	Logical Observation Identifier Names and Codes, Regenstrief Institute
MCD		Medicaid billing codes/names.
MCR		Medicare billing codes/names.
MDDX		Medispan diagnostic codes (drug-diagnosis interaction)
MDNS		Universal Medical Device (UMD) Nomenclature System

MEDC		Medical Economics Drug Codes
MEDR		Medical Dictionary for Drug Regulatory Affairs (MEDDRA)
MEDX		Medical Economics Diagnostic Codes
MGPI		Medispan GPI – hierarchical drug codes
MVX		CDC Vaccine Codes
NCDR		American College of Cardiology National Cardiovascular Data Registry™ Cath Lab Module Version 1.1, 1997; Version 2.0b, 1999
NDC		National drug codes, FDA
NIC		Nursing Interventions – Iowa Intervention Project
NPI		HCFA National Provider Identifier
OHA		Omaha System – Omaha Visiting Nurse Association
POS	2.16.840.1.113883.6.50	HCFA Place of Service (POS) Codes for Professional Claims
RC		Read Clinical Classification of Medicine
RFC3066		RFC 3066, Tags for the Identification of Languages, Internet Engineering Task Force
99SDM		SNOMED Version 3 (Retired)
S3		SNOMED Version 3 (never used in DICOM)
SCPECG		Standard Communications Protocol for Computer-Assisted Electrocardiography, Draft proposal for ISO Standard, AAMI, Revision 1.3
SNM		SNOMED (never used in DICOM)
SNM3	2.16.840.1.113883.6.51	SNOMED International_Version 3
SNT		SNOMED topology codes (never used in DICOM)
SRT	2.16.840.1.113883.6.5	SNOMED-RT (Referenced Terminology)
UC		UCDS Uniform Clinical Data Systems
UCUM	2.16.840.1.113883.6.8	Unified Code for Units of Measure
UMD		Universal Medical Device Nomenclature System (MDNS).
UML		Unified Medical Language
UPC	2.16.840.1.113883.6.55	Universal Product Code - Universal Code Council
UPIN		HCFA Universal Physician Identification Numbers
W1		World Health organization record number drug codes - six digit code
W2		World Health organization record number drug codes - eight digit code
W4		World Health organization record number drug codes with ASTM extensions (see appendix A of ASTM 1238-91)
WC		WHO's ATC codes provide a hierarchical classification of drugs by therapeutic class.

Note: Coding Scheme Designator ISO5218\_1 was improperly specified in earlier editions of the standard. The codes attributed to that coding scheme have been added to the DICOM Controlled Terminology, and thus all references to coding scheme ISO5218\_1 should be considered equivalent to coding scheme DCM.

## Annex A      Structured Reporting Templates (Normative)

This Annex specifies the content of Standard Templates that may be used by DICOM SR IODs.

### GENERAL TEMPLATES

#### TID 300 Measurement

This Template provides a general structure for a numeric measurement, together with evaluations of its normality and/or significance, and the inference source(s) for its value. This structure is instantiated by inclusion of this Template with specific contextual parameters from a parent Template.

#### TID 300 Parameters

Parameter Name	Parameter Usage
\$Measurement	Coded term or Context Group for Concept Name of measurement
\$Units	Units of Measurement
\$ModType	Modifier Name for Concept Name of measurement
\$ModValue	Modifier Value for Concept Name of measurement
\$Method	Value for Measurement Method
\$Derivation	Value for Measurement Derivation
\$TargetSite	Value for Anatomic Location of measurement
\$TargetSiteMod	ModifierValue for Anatomic Location of measurement
\$Equation	Coded term or Context Group for the equation or table from which the measurement was derived or computed
\$ImagePurpose	Purpose of Reference for an image used as a source of the measurement
\$WavePurpose	Purpose of Reference for a waveform used as a source of the measurement
\$RefAuthority	Bibliographic reference or authority for statistical properties of a reference population
\$RangeAuthority	Bibliographic reference or authority for the normal range of the measurement

#### TID 300 Measurement Type: Extensible

	NL	Relation with Parent	Value Type	Concept Name	VM	Req Type	Condition	Value Set Constraint
1			NUM	\$Measurement	1	M		Units = \$Units
2	>	HAS CONCEPT MOD	CODE	\$ModType	1-n	U		\$ModValue
3	>	HAS CONCEPT MOD	CODE	EV (G-C036, SRT, "Measurement Method")	1	U		\$Method
4	>	HAS CONCEPT MOD	CODE	EV (121401, DCM, "Derivation")	1	U		\$Derivation
5	>	HAS CONCEPT MOD	CODE	EV (G-C0E3, SRT, "Finding Site")	1	U		\$TargetSite
6	>>	HAS CONCEPT MOD	CODE	EV (G-C171, SRT, "Laterality")	1	U		DCID (244) Laterality



	NL	Relation with Parent	Value Type	Concept Name	VM	Req Type	Condition	Value Set Constraint
7	>>	HAS CONCEPT MOD	CODE	DT (G-A1F8, SRT, "Topographical modifier")	1	U		\$TargetSiteMod
8	>	HAS PROPERTIES	INCLUDE	DTID (310) Measurement Properties	1	U		\$RefAuthority = \$RefAuthority \$RangeAuthority = \$RangeAuthority
9	>	INFERRED FROM	NUM		1-n	U		
10	>	R-INFERRED FROM	NUM		1-n	U		
11	>	INFERRED FROM	INCLUDE	DTID (315) Equation or Table	1	UC	XOR Row 12	\$Equation = \$Equation
12	>	INFERRED FROM	TEXT	DCID (228) Equation or Table	1	UC	XOR Row 11	
13	>		INCLUDE	DTID (320) Image or Spatial Coordinates	1-n	U		\$Purpose = \$ImagePurpose
14	>		INCLUDE	DTID (321) Waveform or Temporal Coordinates	1-n	U		\$Purpose = \$WavePurpose
15	>		INCLUDE	DTID (1000) Quotation	1	U		

### Content Item Descriptions

Rows 2, 3, 4, 5 - The HAS CONCEPT MOD items allow the explicit definition of terms for post-coordination of the measurement concept name. Additional post-coordinated modifier terms may be included in a SOP Instance based on this template, in accordance with section 6.2.4.

Rows 9, 10 - The INFERRED FROM items allow the specification (by-value or by-reference) of numeric values that were used in the derivation of the numeric measurement of Row 1. The nature of the inference is not explicitly conveyed; it may be implicit in the Concept Names of the measurements. Inference by-reference is valid only in SOP Classes that permit the INFERRED FROM relationship by-reference.

### TID 310 Measurement Properties

This Template provides the properties of a numeric measurement, including evaluations of its normality and/or significance, its relationship to a reference population, and an indication of its selection from a set of measurements.

#### TID 310 Parameters

Parameter Name	Parameter Usage
\$RefAuthority	Bibliographic reference or authority for statistical properties of a reference population
\$RangeAuthority	Bibliographic reference or authority for the normal range of the measurement

#### TID 310 Measurement Properties Type: Extensible

	NL	Relation with Parent	Value Type	Concept Name	VM	Req Type	Condition	Value Set Constraint
1			CODE	EV (121402, DCM,	1	U		DCID (222) Normality

	NL	Relation with Parent	Value Type	Concept Name	VM	Req Type	Condition	Value Set Constraint
				"Normality")				Codes
2			INCLUDE	DTID (311) Measurement Statistical Properties	1	U		\$RefAuthority = \$RefAuthority
3			INCLUDE	DTID (312) Normal Range Properties	1	U		\$RangeAuthority = \$RangeAuthority
4			CODE	EV (121403, DCM, "Level of Significance")	1	U		DCID (220) Level of Significance
5			NUM	DCID (225) Measurement Uncertainty Concepts	1-n	U		
6			CODE	EV (121404, DCM, "Selection Status")	1	U		DCID (224) Selection Method

### TID 311 Measurement Statistical Properties

This Template provides the statistical properties of a reference population for a numeric measurement, and/or the position of a measurement in such a reference population.

#### TID 311 Parameters

Parameter Name	Parameter Usage
\$RefAuthority	Bibliographic reference or authority for statistical properties of a reference population

### TID 311 Measurement Statistical Properties Type: Extensible

	NL	Relation with Parent	Value Type	Concept Name	VM	Req Type	Condition	Value Set Constraint
1			NUM	DCID (221) Measurement Range Concepts	1-n	M		
2			TEXT	EV (121405, DCM, "Population description")	1	U		
3			TEXT	EV (121406, DCM, "Reference Authority")	1	UC	XOR row 4	
4			CODE	EV (121406, DCM, "Reference Authority")	1	UC	XOR row 3	\$RefAuthority

### TID 312 Normal Range Properties

This Template provides the normal range of values for a numeric measurement.

#### TID 312 Parameters

Parameter Name	Parameter Usage
\$RangeAuthority	Bibliographic reference or authority for the normal range of the measurement

**TID 312**  
**Normal Range Properties**  
**Type: Extensible**

	NL	Relation with Parent	Value Type	Concept Name	VM	Req Type	Condition	Value Set Constraint
1			NUM	DCID (223) Normal Range Values	1-n	M		
2			TEXT	EV (121407, DCM, "Normal Range description")	1	U		
3			TEXT	EV (121408, DCM, "Normal Range Authority")	1	UC	XOR row 4	
4			CODE	EV (121408, DCM, "Normal Range Authority")	1	UC	XOR row 3	\$RangeAuthority

**TID 315 Equation or Table**

**TID 315 Parameters**

Parameter Name	Parameter Usage
\$Equation	Coded term or Context Group for the equation or table from which a measurement was derived or computed

**TID 315**  
**Equation or Table**  
**Type: Extensible**

	NL	Relation with Parent	Value Type	Concept Name	VM	Req Type	Condition	Value Set Constraint
1			CODE	DCID (228) Equation or Table	1	M		\$Equation
2	>	HAS PROPERTIES	NUM		1-n	U		
3	>	R-HAS PROPERTIES	NUM		1-n	U		

**Content Item Descriptions**

Row 2 - The HAS PROPERTIES allows the specification of the numeric values used as input to the equation or table identified in Row 1.

Row 3 - The HAS PROPERTIES allows the specification by-reference of the numeric values used as input to the equation or table. This row is valid only in SOP Classes that permit the HAS PROPERTIES relationship by-reference.

Note: For example, if Row 1 identifies a specific Body Surface Area equation, Rows 2 and 3 can be used to convey (by-value or by-reference) the Patient Height and Patient Weight numeric measurements used in the BSA computation.

**TID 320 Image or Spatial Coordinates**

This Template provides a general structure for inference from an image, either as a whole, or with specific spatial coordinates, as a single included Template in the invoking Template. If allowed by the IOD, the Image Content Item may be included by-reference.

**TID 320 Parameters**

Parameter Name	Parameter Usage
\$Purpose	Purpose of Reference for an image used as a source of the measurement

**TID 320  
Image or Spatial Coordinates  
Type: Extensible**

	NL	Relation with Parent	Value Type	Concept Name	VM	Req Type	Condition	Value Set Constraint
1		INFERRED FROM	IMAGE	\$Purpose	1	MC	XOR Rows 2, 3	
2		R-INFERRED FROM	IMAGE		1	MC	XOR Rows 1, 3	
3		INFERRED FROM	SCoord	\$Purpose	1	MC	XOR Rows 1, 2	
4	>	SELECTED FROM	IMAGE		1	MC	XOR Row 5	
5	>	R-SELECTED FROM	IMAGE		1	MC	XOR Row 4	

**TID 321 Waveform or Temporal Coordinates**

This Template provides a general structure for referencing a waveform, either as a whole, or with specific temporal coordinates, as a single included Template in the invoking Template. If allowed by the IOD, the Waveform Content Item may be included by-reference.

**TID 321 Parameters**

Parameter Name	Parameter Usage
\$Purpose	Purpose of Reference for a waveform used as a source of the measurement

**TID 321  
Waveform or Temporal Coordinates  
Type: Extensible**

	NL	Relation with Parent	Value Type	Concept Name	VM	Req Type	Condition	Value Set Constraint
1		INFERRED FROM	WAVEFORM	\$Purpose	1	MC	XOR Rows 2, 3	
2		R-INFERRED FROM	WAVEFORM		1	MC	XOR Rows 1, 3	
3		INFERRED FROM	TCoord	\$Purpose	1	MC	XOR Rows 1, 2	
4	>	SELECTED FROM	WAVEFORM		1	MC	XOR Row 5	

	NL	Relation with Parent	Value Type	Concept Name	VM	Req Type	Condition	Value Set Constraint
5	>	R-SELECTED FROM	WAVEFORM		1	MC	XOR Row 4	

### TID 350 References to Supporting Evidence

This template provides references to supporting evidence in the form of DICOM composite objects. This includes references to images, spatial coordinates on images, and other composite objects, such as Structured Reports.

### TID 350 REFERENCES TO SUPPORTING EVIDENCE

Type: Non-Extensible

	NL	Rel with Parent	VT	Concept Name	VM	Req Type	Condition	Value Set Constraint
1			IMAGE	BCID (7003) Diagnostic Imaging Report Purposes of Reference	1-n	U		
2			SCOORD	BCID (7003) Diagnostic Imaging Report Purposes of Reference	1-n	U		
3	>	SELECTED FROM	IMAGE		1	M		
4			COMPOSITE	DT (122073, DCM, "Current procedure evidence")	1-n	U		
5	>	HAS CONCEPT MOD	CODE	EV (121144, DCM, "Document Title")	1	U		

### TID 351 Previous Reports

This general template provides a means to reference previous structured reporting composite object instances.

### TID 351 PREVIOUS REPORTS

Type: Extensible

	NL	Rel with Parent	VT	Concept Name	VM	Req Type	Condition	Value Set Constraint
1			CONTAINER	EV (111549, DCM, "Previous Reports")	1	M		
2	>	CONTAINS	COMPOSITE		1-n	M		

### Content Item Descriptions

Row 2	Concept Name may be the Root Concept Name (title) of a Structured Report composite object instance.
-------	---

**TID 1000 Quotation**

Unless otherwise specified, content in an SR tree is “directly” observed. When material is quoted (from a source that is either a document or something spoken), then it is necessary to specify:

- the fact that one is quoting
- who is doing the quoting
- the source of the quote
- who is being quoted, and who and what the quote is about

This template establishes a mechanism for quoting by specifying:

- the fact that one is quoting, by the presence of the contents of the template in the tree
- that the “observer context” above the invocation of this template establishes who is doing the quoting
- the source of the quote, by the values of the content items in this template
- who is being quoted, and who and what the quote is about, by the observation context that is established at the start of the quoted material

This template may be invoked recursively, to nest quotes within quotes. In essence, the chain of who is quoting whom can be established by maintaining a “stack” of observer context.

If a dimension of observation context is the same in the quoted material as in the enclosing tree, then the observation context does not need to be respecified (e.g. the quote may be about the same subject or procedure). Typically, the observer context would change (unless one were quoting oneself).

In the case of quoting something that was spoken, the “observer” is the person speaking.

TID 1000 is attached using HAS OBS CONTEXT relationships to the top node of the material that is being quoted. The presence of the Quoted Source concept signals the fact that the material is quoted rather than directly observed.

**TID 1000  
QUOTATION  
Type: Extensible**

NL	Rel with Parent	VT	Concept Name	VM	Req Type	Condition	Value Set Constraint
1	HAS OBS CONTEXT	CODE	EV (121001, DCM, "Quotation Mode")	1	M		EV (121003, DCM, "Document") EV (121004, DCM, "Verbal")
2	HAS OBS CONTEXT	COMPOSITE	EV(121002,DCM,"Quoted Source")	1	MC	Required if quoted material source is a DICOM composite object	
3	HAS OBS CONTEXT	INCLUDE	DTID (1001) "Observation Context"	1	M		

**TID 1001 Observation Context**

Specifies attributes of observation context that may be defined, extended or replaced at any location in the SR tree.

This includes attributes that specify:

- who or what the observation is about (“subject context”)
- what procedure the observation is about (“procedure context”)
- who or what is making the observation (“observer context”)

Establishing context includes two aspects of each dimension: identification and description (e.g. patient name and ID vs. patient’s age, height or weight).

Whenever one dimension of context is changed or an attribute is added, all attributes of that dimension of context are “flushed”, that is they need to be repeated in their entirety. For example, when the subject is changed from patient (name, id) to fetus (number), then the parameters of the patient are discarded. E.g. the patient’s ID does not apply to the fetus.

“Extending” the same class and dimension of observation context isn’t feasible, since one cannot “null out” or remove a previously set attribute. Any time a dimension of observation context is “replaced”, any attributes that are unspecified remain unspecified (i.e. they are not inherited).

**TID 1001**  
**OBSERVATION CONTEXT**  
Type: Non-Extensible

NL	Rel with Parent	VT	Concept Name	VM	Req Type	Condition	Value Set Constraint
1	HAS OBS CONTEXT	INCLUDE	DTID (1002) “Observer Context”	1-n	MC	Required if all aspects of observer context are not inherited.	Defaults to the attributes of the Author Observer Sequence (0040,A078), or the Verifying Observer Sequence (0040,A073) if the Author Observer Sequence is not present
2	HAS OBS CONTEXT	INCLUDE	DTID (1005) “Procedure Context”	1	MC	Required if all aspects of procedure context are not inherited.	
3	HAS OBS CONTEXT	INCLUDE	DTID (1006) “Subject Context”	1	MC	Required if all aspects of observation subject context are not inherited.	

**TID 1002            Observer Context**

The observer (person or device) that created the Content Items to which this context applies.

Whenever this template is invoked, all previously inherited attributes of Observer Context are discarded and replaced.

There may be more than one observer, as this template may be invoked with a VM 1-n, and both person and device observers. In such a case, the Content Items of TID 1003 and 1004 shall be included in the order in which the values of Observer Type are specified. Since TID 1003 and 1004 both include a single mandatory Content Item as their first Content Item, which observer is being described can be determined

**TID 1002**  
**OBSERVER CONTEXT**  
Type: Non-Extensible

	NL	Rel with Parent	VT	Concept Name	VM	Req Type	Condition	Value Set Constraint
1		HAS OBS CONTEXT	CODE	EV (121005,DCM, "Observer Type")	1	MC	IF Observer type is device	DCID (270) Observer Type Defaults to (121006,DCM, "Person")
2		HAS OBS CONTEXT	INCLUDE	DTID (1003) Person observer identifying attributes	1	MC	IFF Row 1 value = (121006,DCM, "Person") or Row 1 is absent	
3		HAS OBS CONTEXT	INCLUDE	DTID (1004) Device observer identifying attributes	1	MC	IFF Row 1 value = (121007,DCM, "Device")	

**TID 1003 Person Observer Identifying Attributes**

This template contains identifying (and optionally descriptive) attributes of persons that are observers.

**TID 1003  
PERSON OBSERVER IDENTIFYING ATTRIBUTES  
Type: Extensible**

	NL	Rel with Parent	VT	Concept Name	VM	Req Type	Condition	Value Set Constraint
1			PNAME	EV (121008,DCM, "Person Observer Name")	1	M		
2			TEXT	EV (121009,DCM, " Person Observer's Organization Name")	1	U		Defaults to Institution Name (0008,0080) of the General Equipment Module
3			CODE	EV (121010,DCM, " Person Observer's Role in the Organization")	1	U		BCID(7452) Organizational Roles
4			CODE	EV (121011,DCM, " Person Observer's Role in this Procedure")	1	U		BCID(7453) Performing Roles

**TID 1004 Device Observer Identifying Attributes**

This template (derived from the DICOM General Equipment Module of PS3.3) contains identifying (and optionally descriptive) attributes of devices that are observers.

**TID 1004  
DEVICE OBSERVER IDENTIFYING ATTRIBUTES  
Type: Extensible**

	NL	Rel with Parent	VT	Concept Name	VM	Req Type	Condition	Value Set Constraint
1			UIDREF	EV (121012,DCM, "Device Observer UID")	1	M		
2			TEXT	EV (121013,DCM, "Device Observer Name")	1	U		Defaults to value of Station Name (0008,1010) in General Equipment Module
3			TEXT	EV (121014,DCM, "Device Observer Manufacturer")	1	U		Defaults to value of Manufacturer (0008,0070) in General Equipment Module



4		TEXT	EV (121015,DCM, "Device Observer Model Name")	1	U		Defaults to value of Manufacturer's Model Name (0008,1090) in General Equipment Module
5		TEXT	EV (121016,DCM, "Device Observer Serial Number")	1	U		Defaults to value of Device Serial Number (0018,1000) in General Equipment Module
6		TEXT	EV (121017,DCM, "Device Observer Physical Location during observation")	1	U		

**TID 1005 Procedure Context**

This template contains identifying (and optionally descriptive) attributes of the procedure that is the source of evidence being interpreted.

Whenever this template is invoked, all previously inherited attributes of Procedure Context are discarded and replaced.

Note: If an observed digital image is identified by other than a DICOM UID, a Study Instance UID must be generated for the non-DICOM evidence. The same must be done to document interpretation of hard-copy radiographs generated outside of the scope of the DICOM system.

**TID 1005  
PROCEDURE CONTEXT  
Type: Non-Extensible**

	NL	Rel with Parent	VT	Concept Name	VM	Req Type	Condition	Value Set Constraint
1			UIDREF	EV (121018,DCM, "Procedure Study Instance UID")	1	U		Defaults to Study Instance UID (0020,000D ) of General Study Module
2			UIDREF	EV (121019,DCM, "Procedure Study Component UID")	1-n	U		Defaults to Referenced SOP Instance UID (0008,1155) in Referenced Performed Procedure Step Sequence (0008,1111) of General Series Module
3			TEXT	EV (121020,DCM, "Procedure HL7 Placer Number of Evidence")	1	U		Defaults to (0040,2016)
4			TEXT	EV (121021,DCM, "Procedure HL7 Filler Number of Evidence")	1	U		Defaults to (0040,2017)
5			TEXT	EV(121022,DCM,"Procedure Accession Number")	1	U		Defaults to (0008,0050)
6			CODE	EV(121023,DCM,"Procedure Code")	1	U		Defaults to Procedure Code Sequence (0008,1032) of General Study Module

**TID 1006 Subject Context**

This template contains identifying (and optionally descriptive) attributes of the subject of the interpretation.

Subject context identifies (and optionally) describes the subject of the interpretation, whether it be a patient (human or animal), a fetus (human or animal), or a specimen.

**TID 1006**  
**SUBJECT CONTEXT**  
Type: Non-Extensible

	NL	Rel with Parent	VT	Concept Name	VM	Req Type	Condition	Value Set Constraint
1			CODE	EV (121024, DCM, "Subject Class")	1	MC	IF subject is not the Patient	DCID (271) Observation Subject Class Defaults to (121025, DCM, "Patient")
2			INCLUDE	DTID (1007) Subject Context, Patient	1	UC	IFF Row 1 value = (121025,DCM, "Patient") or Row 1 is absent	May be used for human or animal patients
3			INCLUDE	DTID (1008) Subject Context, Fetus	1	UC	IFF Row 1 value = (121026,DCM, "Fetus")	May be used for human or animal fetuses
4			INCLUDE	DTID (1009) Subject Context, Specimen	1	UC	IFF Row 1 value = (121027, DCM, "Specimen")	

**TID 1007 Subject Context, Patient**

Identifies (and optionally describes) a patient who is the subject.

**TID 1007**  
**SUBJECT CONTEXT, PATIENT**  
Type: Extensible

	NL	Rel with Parent	VT	Concept Name	VM	Req Type	Condition	Value Set Constraint
1			UIDREF	EV (121028,DCM, "Subject UID")	1	U		E.g. SOP Instance UID of Detached Patient Instance
2			PNAME	EV (121029,DCM, "Subject Name")	1	MC	Required if not inherited.	Defaults to value of Patient's Name (0010,0010) in Patient Module
3			CODE	EV (121030,DCM, "Subject ID")	1	MC	Required if not inherited.	Defaults to value of Patient ID (0010,0020) in Patient Module
4			DATE	EV (121031,DCM, "Subject Birth Date")	1	U		Defaults to value of Patient's Birth Date (0010,0030) in Patient Module
5			CODE	EV (121032,DCM, "Subject Sex")	1	U		Defaults to value equivalent to Patient's Sex (0010,0040) in Patient Module DCID (7455) Sex
6			NUM	EV (121033,DCM, "Subject Age")	1	U		Defaults to value of Patient's Age (0010,1010) in Patient Study Module Units DCID (7456) Units of Measure for Age
7			CODE	EV (121034,DCM, "Subject Species")	1	MC	Required if not inherited.	DCID (7454) Species to define various animals or plants, e.g. veterinary or research. Defaults to (L-85B00, SNM3,"homo sapiens").

8			CODE	EV (121035,DCM, "Subject Breed")	1	U		Defaults to value of Patient Breed Code Sequence (0010,2293) in General Patient Module DCID (7480)
---	--	--	------	----------------------------------	---	---	--	---

**TID 1008 Subject Context, Fetus**

Identifies (and optionally describes) a fetus who is the subject.

**TID 1008  
SUBJECT CONTEXT, FETUS  
Type: Extensible**

	NL	Rel with Parent	VT	Concept Name	VM	Req Type	Condition	Value Set Constraint
1			PNAME	EV (121036,DCM, "Mother of fetus")	1	U		Defaults to an observation subject that is a patient prior to replacing the Observation Subject Class with Fetus.
2			UIDREF	EV (121028,DCM, "Subject UID")	1	U		For longitudinal tracking of individual fetuses
3			TEXT	EV (121030,DCM, "Subject ID")	1	MC	IF row 4 is absent	For longitudinal tracking of individual fetuses (human readable value e.g. "A" or "1")
4			TEXT	EV (11951-1,LN, "Fetus ID")	1	MC	IF row 3 is absent	For separation of multiple fetuses during this procedure e.g. fetus '1' of '2' ... not for longitudinal comparisons.; ie. the "m" of fetus "m" of "n"
5			NUM	EV (11878-6,LN, "Number of Fetuses")	1	U		i.e. the "n" of fetus "m" of "n"  Units EV (1,UCUM,"no units")

**TID 1009 Subject Context, Specimen**

Identifies (and optionally describes) a specimen that is the subject.

**TID 1009  
SUBJECT CONTEXT, SPECIMEN  
Type: Extensible**

	NL	Rel with Parent	VT	Concept Name	VM	Req Type	Condition	Value Set Constraint
1			UIDREF	EV (121039,DCM, "Specimen UID")	1	U		
2			TEXT	EV (121040,DCM, "Specimen Accession Number")	1	U		Defaults to value of Specimen Accession Number (0040,050A ) in Specimen Identification Module
3			INCLUDE	DTID (1007) "patient subject context"	1	UC	IFF the source of the specimen is a human or animal patient	
4			TEXT	EV (121041,DCM, "Specimen Identifier")	1	U		Defaults to value of Specimen Identifier (0040,0551) if a single item of Specimen Sequence (0040,0550) is present in Specimen Identification Module
5			CODE	EV (121042,DCM, "Specimen Type")	1	U		Defaults to value of Specimen Type Code Sequence (0040,059A) if a single item of Specimen Sequence (0040,0550) is

							present in Specimen Identification Module
6		TEXT	EV (121043,DCM, "Slide Identifier")	1	U		Defaults to value of Slide Identifier (0040,06FA ) if a single item of Specimen Sequence (0040,0550) is present in Specimen Identification Module
7		UIDREF	EV (121044,DCM, "Slide UID")	1	U		

### TID 1200 Language Designation

Defines a mechanism for specifying a language, optionally with designation of the country in which that language applies.

- Notes:
1. For example, the French language could be specified unmodified, or French as written in France or Canada could be distinguished.
  2. The language codes specified in CID 5000 optionally allow the encoding of the country of language in the code value for the language. Encoding of the country of language in a separate subsidiary Concept Modifier content item is allowed for backward compatibility with previous editions of the Standard.

### TID 1200 LANGUAGE DESIGNATION Type: Extensible

	NL	Rel with Parent	VT	Concept Name	VM	Req Type	Condition	Value Set Constraint
1			CODE	(121045,DCM,"Language")	1	M		DCID(5000)
2	>	HAS CONCEPT MOD	CODE	(121046,DCM,"Country of Language")	1	U		DCID(5001)

### TID 1201 Language of Value

Defines a mechanism for specifying the language in which the value of the parent content item (only) is written. Does not specify the language of the Concept Name of the parent content item, nor of any other descendants of the parent content item.

- Note:
- The language codes specified in CID 5000 optionally allow the encoding of the country of language in the code value for the language. Encoding of the country of language in a separate subsidiary Concept Modifier content item is allowed for backward compatibility with previous editions of the Standard.

### TID 1201 LANGUAGE OF VALUE Type: Non-Extensible

	NL	Rel with Parent	VT	Concept Name	VM	Req Type	Condition	Value Set Constraint
1		HAS CONCEPT MOD	CODE	(121047,DCM,"Language of Value")	1	M		DCID(5000)
2	>	HAS CONCEPT MOD	CODE	(121046,DCM,"Country of Language")	1	U		DCID(5001)

**TID 1202 Language of Name and Value**

Defines a mechanism for specifying the language in which the value and the Concept Name of the parent content item (only) is written. Does not specify the language of any other descendants of the parent content item.

Note: The language codes specified in CID 5000 optionally allow the encoding of the country of language in the code value for the language. Encoding of the country of language in a separate subsidiary Concept Modifier content item is allowed for backward compatibility with previous editions of the Standard.

**TID 1202  
LANGUAGE OF NAME AND VALUE  
Type: Extensible**

	NL	Rel with Parent	VT	Concept Name	VM	Req Type	Condition	Value Set Constraint
1		HAS CONCEPT MOD	CODE	(121048,DCM,"Language of Name and Value")	1	M		DCID(5000)
2	>	HAS CONCEPT MOD	CODE	(121046,DCM,"Country of Language")	1	U		DCID(5001)

**TID 1204 Language of Content Item and Descendants**

Defines a mechanism for specifying the language in which the value and the Concept Name of the parent content item and any other descendants of the parent content item is written.

Note: The language codes specified in CID 5000 optionally allow the encoding of the country of language in the code value for the language. Encoding of the country of language in a separate subsidiary Concept Modifier content item is allowed for backward compatibility with previous editions of the Standard.

**TID 1204  
LANGUAGE OF CONTENT ITEM AND DESCENDANTS  
Type: Non-Extensible**

	NL	Rel with Parent	VT	Concept Name	VM	Req Type	Condition	Value Set Constraint
1		HAS CONCEPT MOD	CODE	(121049,DCM,"Language of Content Item and Descendants")	1	M		DCID(5000)
2	>	HAS CONCEPT MOD	CODE	(121046,DCM,"Country of Language")	1	U		DCID(5001)

**TID 1210 Equivalent Meaning(s) of Concept Name**

Defines a mechanism for specifying one or more equivalent meanings for the Concept Name of the parent content item.

**TID 1210  
EQUIVALENT MEANING(S) OF CONCEPT NAME  
Type: Non-Extensible**

	NL	Rel with Parent	VT	Concept Name	VM	Req Type	Condition	Value Set Constraint
1		HAS CONCEPT	TEXT	(121050,DCM,"Equivalent Meaning of Concept Name")	1-n	MC	XOR Row 3	Plain text equivalent of code meaning of the concept name

		MOD						of the content item being modified, in the specified language from the specified country, using the default character set or a character set selected from Specified Character Set
2	>		INCLUDE	DTID(1201) Language of Value	1	U		
3		HAS CONCEPT MOD	CODE	(121050,DCM,"Equivalent Meaning of Concept Name")	1-n	MC	XOR Row 1	
4	>		INCLUDE	DTID(1201) Language of Value	1	U		

**TID 1211 Equivalent Meaning(s) of Value**

Defines a mechanism for specifying one or more equivalent meanings for the Value of the parent content item.

**TID 1211  
EQUIVALENT MEANING(S) OF VALUE  
Type: Extensible**

	NL	Rel with Parent	VT	Concept Name	VM	Req Type	Condition	Value Set Constraint
1		HAS CONCEPT MOD	TEXT	(121051,DCM,"Equivalent Meaning of Value")	1-n	MC	XOR Row 3	Plain text equivalent of code meaning of the value of the content item being modified, in the specified language from the specified country, using the default character set or a character set selected from Specified Character Set
2	>		INCLUDE	DTID(1201) Language of Value	1	U		
3		HAS CONCEPT MOD	CODE	(121051,DCM,"Equivalent Meaning of Value")	1-n	MC	XOR Row 1	
4	>		INCLUDE	DTID(1201) Language of Value	1	U		

Notes. 1. For example, to describe a longer, more meaningful equivalent (in the same language) for a procedure code than is defined in a coding scheme:

CODE:(121023,DCM,"Procedure Code")=(50291CC,ICD10PCS,"IMAGING:CNS:CT:SELLA:LOWOSMOLAR:IT,U,E:2PLANE3D")  
> *Has Concept Mod* TEXT:(121051,DCM,"Equivalent meaning of value")="imaging study central nervous system of the sella turcica/pituitary gland with low osmolar contrast intrathecal, unenhanced and enhanced, in two planes with 3D reconstructions"

2. For example, to specify a concept name and value in both French and English in Canada:

CODE:(T-D0005,SNM3,"Anatomical structure")=(T-04000,SNM3,"Breast")  
> *Has Concept Mod* CODE:(121048,DCM,"Language of name and value")=(en-CA,RFC3066,"English, Canada")

> *Has Concept Mod* CODE: (121050,DCM,"Equivalent meaning of concept name")=(T-D0005,SNM3,"Structure de l'anatomie")  
>> *Has Concept Mod* CODE: (121047,DCM,"Langue de la valeur")=(fr-CA,RFC3066,"Français, Canadie")  
> *Has Concept Mod* CODE: (121051,DCM,"Equivalent meaning of value")=(T-04000,SNM3,"Sein")  
>> *Has Concept Mod* CODE: (121047,DCM,"Langue de la valeur")=(fr-CA,RFC3066,"Français, Canadie")

**TID 1350 Negation Modifier, Presence of Finding**

Concept Name Modifier for negation of the presence of a finding represented by a post-coordinated concept.

- Notes.
1. For example, negation modifier applied to "sclera" in the post-coordinated structure:  
CODE: anatomic location = "bile duct"  
> HAS PROPERTY -- CODE: morphology = "distention"  
>> HAS CONCEPT MOD -- CODE – "presence of property" = "absent"  
means: "bile duct distention not present"
  2. The presence-negation modifier modifies the entire post-coordinated concept, not just the source content item of the HAS CONCEPT MOD relationship. The entire branch of the tree from the content item is included in the post-coordinated structure that is negated.

**TID 1350**  
**NEGATION MODIFIER, PRESENCE OF FINDING**  
Type: Extensible

	NL	Rel with Parent	VT	Concept Name	VM	Req Type	Condition	Value Set Constraint
1		HAS CONCEPT MOD	CODE	EV(121052,DCM,"Presence of property")	1	M		DCID (240) Present-Absent



**TID 1400 Linear Measurement Template**

**TID 1400  
LINEAR MEASUREMENT  
Type: Extensible**

	NL	Rel with Parent	VT	Concept Name	VM	Req Type	Condition	Value Set Constraint
1			NUM	DCID (7470) "Linear Measurements"	1	M		UNITS = DCID(7460) "Units of Linear Measurement"
2	>	INFERRED FROM	SCoord	EV (121055,DCM, "Path")	1	UC	XOR Row 5	GRAPHIC TYPE = {POLYLINE, CIRCLE, ELLIPSE}
3	>>	R-SELECTED FROM	IMAGE		1	MC	XOR Row 4	
4	>>	SELECTED FROM	IMAGE		1	MC	XOR Row 3	
5	>	INFERRED FROM	SCoord	EV (121230, DCM, "Path Vertex")	2-n	UC	XOR Row 2	GRAPHIC TYPE = {POINT}
6	>>	R-SELECTED FROM	IMAGE		1	MC	XOR Row 7	
7	>>	SELECTED FROM	IMAGE		1	MC	XOR Row 6	

**Content Item Descriptions**

Row 2 "Path"

Path shall represent the measured path or a projection of the measured path in the image. The Graphic Type (0070,0023) of the \_Path SCoord shall be:

- an open POLYLINE with two different points (to measure length, diameter, distance, proximity, etc),
- a CIRCLE or ELLIPSE (to measure circumference) or
- an open or closed POLYLINE (closed polygon) to measure path length (open) or perimeter (closed).

Row 5 "Path Vertex"

A measured path that traverses two or more images (e.g., the ends of the path are in different cross-sectional plane images) shall be identified by vertices along the path. The Path Vertices shall be ordered by the order of their SCoord Content Items to identify the measured path. The Graphic Type (0070,0023) of each SCoord shall be POINT

**TID 1401 Area Measurement Template**

**TID 1401  
AREA MEASUREMENT  
Type: Extensible**

	NL	Rel with Parent	VT	Concept Name	VM	Req Type	Condition	Value Set Constraint
1			NUM	DCID(7471) "Area Measurements"	1	M		Value shall be > 0 UNITS = DCID(7461) "Units of

	NL	Rel with Parent	VT	Concept Name	VM	Req Type	Condition	Value Set Constraint
								Area Measurement"
2	>	INFERRED FROM	SCCOORD	EV (121056,DCM, "Area Outline")	1	MC	Shall be present if concept name of Row 1 is (G-A16A,SRT, "Area of defined region"). May be present otherwise.	GRAPHIC TYPE = not {MULTIPOINT}
3	>>	R-SELECTED FROM	IMAGE		1	MC	XOR Row 4	
4	>>	SELECTED FROM	IMAGE		1	MC	XOR Row 3	

**Content Item Descriptions**

Row 2 "Area Outline"      A Graphic Type of POINT implies that the object is a single pixel and the object's area is the area of the pixel. Otherwise the type shall be a closed POLYLINE (start and end point the same) or a CIRCLE or an ELLIPSE.

**TID 1402      Volume Measurement Template**

**TID 1402  
VOLUME MEASUREMENT  
Type: Extensible**

	NL	Rel with Parent	VT	Concept Name	VM	Req Type	Condition	Value Set Constraint
1			NUM	DCID(7472) "Volume Measurements"	1	M		Value shall be > 0 UNITS = DCID(7462) "Units of Volume Measurement"
2	>	INFERRED FROM	SCCOORD	EV (121057,DCM, "Perimeter Outline")	1-n	U		GRAPHIC TYPE = not {MULTIPOINT}
3	>>	R-SELECTED FROM	IMAGE		1	MC	XOR Row 4	
4	>>	SELECTED FROM	IMAGE		1	MC	XOR Row 3	

**Content Item Descriptions**

Row 2 "Perimeter Outline"      The two dimensional perimeter of the volume's intersection with or projection into the image. A Graphic Type of POINT implies that the volume's intersection or projection in a plane is a single pixel. A single pixel projection perimeter cannot cause a volume calculation to become 0.

Otherwise the type shall be a closed POLYLINE (start and end point the same) or a CIRCLE or an ELLIPSE.

TID 1404      Numeric Measurement Template

TID 1404  
NUMERIC MEASUREMENT  
Type: Extensible

	NL	Rel with Parent	VT	Concept Name	VM	Req Type	Condition	Value Set Constraint
1			NUM	No baseline CID	1	M		Units = DCID (82) Units of Measurement
2	>	INFERRED FROM	SCOORD	No baseline CID	1-n	UC	XOR Row 5, 6	
3	>>	R-SELECTED FROM	IMAGE		1	MC	XOR Row 4	
4	>>	SELECTED FROM	IMAGE		1	MC	XOR Row 3	
5	>	R-INFERRED FROM	IMAGE	BCID (7003) Diagnostic Imaging Report Purposes of Reference	1-n	UC	XOR Row 2,6	
6	>	INFERRED FROM	IMAGE	BCID (7003) Diagnostic Imaging Report Purposes of Reference	1-n	UC	XOR Row 2,5	

**Content Item Descriptions**

- Row 2      The SCOORD may indicate the points or area where the measurement was taken (e.g., a POINT showing the pixel location of a density measurement, or an open POLYLINE of three points showing the calculation of an angle).
- Rows 3,5      Valid only in IODs that permit relationships by-reference.

**TID 2000 Basic Diagnostic Imaging Report**

Basic report template for general diagnostic imaging interpretation reports.

Can only be instantiated at the root node and cannot be included in other templates.

**TID 2000  
BASIC DIAGNOSTIC IMAGING REPORT  
Type: Non-Extensible**

	NL	Rel with Parent	VT	Concept Name	VM	Req Type	Condition	Value Set Constraint
1			CONTAINER	BCID(7000) Diagnostic Imaging Report Document Titles	1	M		Root node
2	>	HAS CONCEPT MOD	CODE	EV (121058,DCM,"Procedure reported")	1-n	U		
3	>	HAS CONCEPT MOD	INCLUDE	DTID(1204) Language of Content Item and Descendants	1	M		
4	>	HAS CONCEPT MOD	INCLUDE	DTID (1210) Equivalent Meaning of Concept Name	1-n	U		
5	>	HAS OBS CONTEXT	INCLUDE	DTID(1001) Observation Context	1	M		
6	>	CONTAINS	CONTAINER	BCID(7001) Diagnostic Imaging Report Headings	1-n	U		
7	>>	HAS OBS CONTEXT	INCLUDE	DTID(1001) Observation Context	1	U		
8	>>	CONTAINS	CODE	BCID(7002) Diagnostic Imaging Report Elements	1-n	U		
9	>>>	INFERRED FROM	INCLUDE	DTID(2001)Basic Diagnostic Imaging Report Observations	1-n	U		
10	>>	CONTAINS	TEXT	BCID(7002) Diagnostic Imaging Report Elements	1-n	U		
11	>>>	INFERRED FROM	INCLUDE	DTID(2001)Basic Diagnostic Imaging Report Observations	1-n	U		
12	>>	CONTAINS	INCLUDE	DTID(2001)Basic Diagnostic Imaging Report Observations	1-n	U		

No content items other than those defined in Observation Context TID 1001 may be the target of a HAS OBS CONTEXT relationship when TID 2000 is invoked.

**TID 2001 Basic Diagnostic Imaging Report Observations**

Individual numeric or image observations that may be useful for inclusion as individual findings or as the source of inferences in a report.

**TID 2001  
BASIC DIAGNOSTIC IMAGING REPORT OBSERVATIONS  
Type: Non-Extensible**

	NL	Rel with Parent	VT	Concept Name	VM	Req Type	Condition	Value Set Constraint
--	----	-----------------	----	--------------	----	----------	-----------	----------------------

1		IMAGE	BCID(7003) Diagnostic Imaging Report Purposes of Reference	1	MC	XOR Rows 2,3,4,5.	
2		INCLUDE	TID(1400) Linear Measurements	1	MC	XOR Rows 1,3,4,5.  Shall not be present if the NUM value type is not supported by the IOD.	
3		INCLUDE	TID(1401) Area Measurements	1	MC	XOR Rows 1,2,4,5.  Shall not be present if the NUM value type is not supported by the IOD.	
4		INCLUDE	TID(1402) Volume Measurements	1	MC	XOR Rows 1,2,3,5.  Shall not be present if the NUM value type is not supported by the IOD.	
5		INCLUDE	TID (1404) Numeric Measurements	1	MC	XOR Rows 1,2,3,4.  Shall not be present if the NUM value type is not supported by the IOD.	

### TID 2005 Transcribed Diagnostic Imaging Report

Basic report template for general diagnostic imaging interpretation reports produced in a dictation/transcription workflow. SR documents encoded using this template are intended to be transformable to HL7 Clinical Document Architecture format (see PS3.17).

This template can be instantiated only at the root node, and cannot be included in other templates.

Observation Context shall be inherited from outside the SR Content tree, and shall not be changed within the Content tree. To satisfy the requirement that Observer Context is inherited, either or both the Author Observer Sequence (0040,A078) or the Verifying Observer Sequence (0040,A073) from the SR Document Module must be present in the SOP Instance.

Note: See Section on Observation Context Encoding in PS3.3

### TID 2005 TRANSCRIBED DIAGNOSTIC IMAGING REPORT Type: Non-Extensible

	NL	Rel with Parent	VT	Concept Name	VM	Req Type	Condition	Value Set Constraint
1			CONTAINER	BCID (7000) Diagnostic Imaging Report Document Titles	1	M		
2	>	HAS CONCEPT MOD	CODE	EV (121049, DCM, "Language of Content Item and Descendants")	1	M		DCID (5000) Language
3	>	CONTAINS	CONTAINER	BCID (7001) Diagnostic Imaging Report Headings	1-n	M		
4	>>	CONTAINS	TEXT	BCID (7002) Diagnostic Imaging Report Elements	1	U		
5	>	CONTAINS	CONTAINER	EV (121180, DCM, "Key Images")	1-n	U		

6	>>	CONTAINS	TEXT	EV (113012, DCM, "Key Object Description")	1	U		
7	>>	CONTAINS	IMAGE	Purpose of Reference is not used	1-n	M		

**Content Item Descriptions**

Row 3 CONTAINER Concept Name may be absent.

Row 7 IMAGE Concept Name shall be absent.

**TID 2010 Key Object Selection**

The Key Object Selection template is intended for flagging one or more significant images, waveforms, or other composite SOP Instances. Key Object Selection contains:

- coded document title stating the reason for significance of the referenced objects in the Key Object Selection,
- optional free form text comment in an explicitly identified language, and
- optional identification of the observer (device or person) which created the Key Object Selection.

- Notes:
1. For instance, when this template is used to identify images rejected for quality reasons, the device or person performing the quality assessment is identified in observation context items (invoked through TID 1002). The reason for rejection can be included both as a code used as a concept modifier for the document title, and as text description.
  2. The order of object references may be significant, e.g., when the title concept is "For Conference".
  3. Instances referenced in a Key Object Selection Document may be securely referenced by Digital Signature or MAC mechanisms within the SR Document General Module (See PS 3.3).

The Template can only be instantiated at the root node and cannot be included in other templates. The Template is not extensible; that is, no other content items may be added to this template, or the templates that are included, recursively.

**TID 2010  
KEY OBJECT SELECTION  
Type: Non-Extensible**

	NL	Rel with Parent	VT	Concept Name	VM	Req Type	Condition	Value Set Constraint
1			CONTAINER	DCID(7010) Key Object Selection Document Titles	1	M		Root node
2	>	HAS CONCEPT MOD	CODE	EV (113011, DCM, "Document Title Modifier")	1-n	U		
3	>	HAS CONCEPT MOD	CODE	EV (113011, DCM, "Document Title Modifier")	1	UC	IF Row 1 Concept Name = (113001, DCM, "Rejected for Quality Reasons") or (113010, DCM, "Quality Issue")	DCID (7011)
4	>	HAS CONCEPT MOD	CODE	EV (113011, DCM, "Document Title Modifier")	1	MC	IF Row 1 Concept Name = (113013, DCM, "Best In Set")	DCID (7012)
5	>	HAS CONCEPT MOD	INCLUDE	DTID(1204) Language of Content Item and Descendants	1	U		
6	>	HAS OBS CONTEXT	INCLUDE	DTID(1002) Observer Context	1-n	U		

7	>	CONTAINS	TEXT	EV(113012, DCM, "Key Object Description")	1	U		
8	>	CONTAINS	IMAGE	Purpose of Reference shall not be present	1-n	MC	At least one of Rows 8, 9 and 10 shall be present	
9	>	CONTAINS	WAVEFORM	Purpose of Reference shall not be present	1-n	MC	At least one of Rows 8, 9 and 10 shall be present	
10	>	CONTAINS	COMPOSITE	Purpose of Reference shall not be present	1-n	MC	At least one of Rows 8, 9 and 10 shall be present	

**PROCEDURE LOG IOD TEMPLATES**

**TID 3001 Procedure Log**

The Procedure Log template is intended for the representation of reports or logs of time-stamped events occurring during an image-guided interventional or other procedure.

This Template does not require a particular ordering of the subsidiary Content Items.

- Notes:
1. The Procedure Log IOD (PS3.3) requires ordering by Observation Datetime; thus log entries of different types (i.e., specified by different Rows in the Template) may appear in any order.
  2. While this Template is extensible, the Procedure Log IOD forbids Container Content Items subsidiary to the top level Container.

**TID 3001  
Procedure Log  
Type: Extensible**

	NL	Relation with Parent	Value Type	Concept Name	VM	Req Type	Condition	Value Set Constraint
1			CONTAINER	DCID (3400) Procedure Log Titles	1	M		
2	>		INCLUDE	DTID (1002) Observer Context	1-n	M		
3	>		INCLUDE	DTID (3601) Procedure Context	1	M		
4	>	HAS ACQ CONTEXT	TEXT	EV (121121, DCM, "Room identification")	1	U		
5	>	HAS ACQ CONTEXT	TEXT	EV (121122, DCM, "Equipment identification")	1-n	U		
6	>	CONTAINS	TEXT	DCID (3401) Types of Log Notes	1-n	U		
7	>>		INCLUDE	DTID (3010) Log Entry Qualifiers	1	U		
8	>	CONTAINS	CODE	EV (121123, DCM, "Patient Status or Event")	1-n	U		DCID (3402) Patient Status and Events
9	>>		INCLUDE	DTID (3010) Log Entry Qualifiers	1	U		
10	>	CONTAINS	PNAME	DCID (3404) Staff Actions	1-n			
11	>>		INCLUDE	DTID (3010) Log Entry Qualifiers	1	U		
12	>	CONTAINS	TEXT	DCID (3427) Equipment Events	1-n	U		Equipment identifier
13	>>		INCLUDE	DTID (3010) Log Entry Qualifiers	1	U		
14	>	CONTAINS	INCLUDE	DTID (3100) Procedure Action	1-n	U		
15	>	CONTAINS	INCLUDE	DTID (3101) Image Acquisition	1-n	U		
16	>	CONTAINS	INCLUDE	DTID (3102) Waveform Acquisition	1-n	U		
17	>	CONTAINS	INCLUDE	DTID (3103) Referenced Object	1-n	U		
18	>	CONTAINS	INCLUDE	DTID (3104) Consumables	1-n	U		
19	>	CONTAINS	INCLUDE	DTID (3105) Lesion Identification and Properties	1-n	U		
20	>	CONTAINS	INCLUDE	DTID (3106) Drugs/Contrast Administered	1-n	U		



	NL	Relation with Parent	Value Type	Concept Name	VM	Req Type	Condition	Value Set Constraint
21	>	CONTAINS	INCLUDE	DTID (3107) Device Used	1-n	U		
22	>	CONTAINS	INCLUDE	DTID (3108) Intervention	1-n	U		
23	>	CONTAINS	CODE	EV (DD-60002, SRT, "Complication of Procedure")	1-n	U		DCID (3413) Adverse Outcomes
24	>>		INCLUDE	DTID (3010) Log Entry Qualifiers	1	U		
25	>	CONTAINS	INCLUDE	DTID (3109) Measurements	1-n	U		
26	>	CONTAINS	INCLUDE	DTID (3110) Impressions or Findings	1-n	U		
27	>	CONTAINS	INCLUDE	DTID (3111) Percutaneous Entry	1-n	U		
28	>	CONTAINS	INCLUDE	DTID (3112) Specimen Obtained	1-n	U		
29	>	CONTAINS	INCLUDE	DTID (3113) Patient Support	1-n	U		
30	>	CONTAINS	INCLUDE	DTID (3114) Patient assessment	1-n	U		
31	>	CONTAINS	INCLUDE	DTID (3115) ECG ST assessment	1-n	U		

### Content Item Descriptions

Row 2 includes TID 1002 Observer Context. TID 1002 shall be used to record the identity of the person responsible for recording the log, as well as all other participants in the procedure, even though these personnel may not technically be "observers" of the Procedure Log. As participants in the procedure, they are potential sources for events and observations recorded in the Log. TID 1002 allows the specification of the person's role in the organization (e.g., physician, nurse), as well as the role in the procedure (e.g., circulating, performing, etc.).

Row 5 shall be used to record the identity of the major equipment used in the procedure.

Row 6 may be used to record any event not covered by a specific log entry template.

### TID 3010 Log Entry Qualifiers

The Log Entry Qualifiers Template provides a common means for adding additional description to a procedure log content item. It allows identification of a source for the procedure log entry (other than the recording observer for the log as a whole), a free text comment, a link to a particular Procedure Action item, a link to a particular lesion, or the date/time of recording (if different than the time of the event occurrence recorded in the Observation Datetime of the parent content item).

#### TID 3010 Log Entry Qualifiers Type: Extensible

	NL	Relation with Parent	Value Type	Concept Name	VM	Req Type	Condition	Value Set Constraint
1			INCLUDE	DTID (1000) Quotation	1	U		
2		HAS PROPERTIES	TEXT	EV (121106, DCM, "Comment")	1	U		
3		HAS OBS CONTEXT	TEXT	EV (121124, DCM, "Procedure Action ID")	1-n	U		

	NL	Relation with Parent	Value Type	Concept Name	VM	Req Type	Condition	Value Set Constraint
4		HAS OBS CONTEXT	TEXT	EV (121151, DCM, "Lesion Identifier")	1-n	U		Up to 3 numeric characters
5		HAS OBS CONTEXT	DATETIME	EV (121125, DCM, "DateTime of Recording of Log Entry")	1	U		
6		INFERRED FROM	IMAGE		1-n	U		
7		INFERRED FROM	WAVEFORM		1-n	U		
8		INFERRED FROM	COMPOSITE		1-n	U		
9		HAS OBS CONTEXT	CODE	EV (121135, DCM, "Observation Datetime Qualifier")	1	U		DCID (3430) Datetime Qualifiers

### Content Item Descriptions

Row 3 Procedure Action ID allows linking recorded events to a particular action, step, or phase of a procedure. See description for TID 3100 Procedure Action.

Row 4 Lesion Identifier is specified as a numeric text string, and allows linking recorded events to the diagnosis or therapy of particular lesion. See description for TID 3105 Lesion Identifier.

### TID 3100 Procedure Action

The Procedure Action Template is intended for the recording of the beginning or end of procedure steps or action items in a procedure. The level of granularity of the recorded events is not specified, and may vary between institutions, or even be at multiple levels within a single procedure log. There is no requirement for the real-world procedure step or action item recorded with this template to end before another one begins; there may be overlapping or simultaneous procedure steps or action items.

This log entry template may be used to record the start or stop of timers.

Other recorded events in the procedure may be linked to a particular step or action item by Procedure Action ID (see TID 3010 Log Entry Qualifiers).

### TID 3100 Procedure Action Type: Extensible

	NL	Relation with Parent	Value Type	Concept Name	VM	Req Type	Condition	Value Set Constraint
1			CODE	DCID (3421) Procedure Action	1	M		BCID (3405) Procedure Action Values
2	>	HAS PROPERTIES	TEXT	EV (121124, DCM, "Procedure Action ID")	1	M		
3	>	HAS PROPERTIES	PNAME	BCID (7453) Performing Roles	1-n	U		
4	>	HAS PROPERTIES	NUM	EV (121128, DCM, "Procedure Action Duration")	1	U		
5	>		INCLUDE	DTID (3010) Log Entry Qualifiers	1	U		
6	>	HAS	UIDREF	EV (121126, DCM,	1	MC	IFF DICOM Modality	

	NL	Relation with Parent	Value Type	Concept Name	VM	Req Type	Condition	Value Set Constraint
		PROPERTIES		"Performed Procedure Step SOP Instance UID")			or General Purpose Performed Procedure Step SOP Class is used to provide status of the Procedure Step	
7	>	HAS PROPERTIES	UIDREF	EV (121127, DCM, "Performed Procedure Step SOP Class UID")	1	MC	IFF DICOM Modality or General Purpose Performed Procedure Step SOP Class is used to provide status of the Procedure Step	

### Content Item Descriptions

Row 2 - The value of the Procedure Action ID shall be uniquely associated with the step or action within the context of the Study, and may be used to associate various Procedure Log entries with the step or action.

Row 3 may be used to record the identity of staff roles for the purpose of this Procedure Action, which may differ from their roles in the procedure as a whole.

### TID 3101 Image Acquisition

The Image Acquisition Template allows recording of the essential parameters of a digital image acquired during the procedure.

#### TID 3101 Image Acquisition Type: Extensible

	NL	Relation with Parent	Value Type	Concept Name	VM	Req Type	Condition	Value Set Constraint
1			IMAGE	EV (121138, DCM, "Image Acquired")	1	M		
2	>	HAS ACQ CONTEXT	UIDREF	EV (112002, DCM, "Series Instance UID")	1	M		
3	>	HAS ACQ CONTEXT	CODE	EV (121139, DCM, "Modality")	1	M		DCID (29) Modalities Derived from referenced image SOP Instance attribute (0008,0060)
4	>	HAS PROPERTIES	NUM	EV (121140, DCM, "Number of Frames")	1	U		
5	>	HAS PROPERTIES	TEXT	EV (121141, DCM, "Image Type")	1	U		From referenced image SOP Instance attribute (0008,0008)
6	>	HAS ACQ CONTEXT	NUM	EV (112011, DCM, "Positioner Primary Angle")	1	U		UNITS = EV (deg, UCUM, "o")
7	>	HAS ACQ CONTEXT	NUM	EV (112012, DCM, "Positioner Secondary Angle")	1	U		UNITS = EV (deg, UCUM, "o")
8	>		INCLUDE	DTID (3010) Log Entry Qualifiers	1	U		

**TID 3102          Waveform Acquisition**

The Waveform Acquisition Template allows recording of the essential parameters of a digital waveform acquired during the procedure.

**TID 3102  
Waveform Acquisition  
Type: Extensible**

	NL	Relation with Parent	Value Type	Concept Name	VM	Req Type	Condition	Value Set Constraint
1			WAVEFORM	EV (121143, DCM, "Waveform Acquired")	1	M		
2	>	HAS ACQ CONTEXT	CODE	EV (121139, DCM, "Modality")	1	M		DCID (29) Modalities Derived from referenced waveform SOP Instance attribute (0008,0060)
3	>	HAS ACQ CONTEXT	NUM	EV (121142, DCM, "Acquisition Duration")	1	U		
4	>		INCLUDE	DTID (3010) Log Entry Qualifiers	1	U		

**TID 3103          Referenced Object**

The Referenced Object Template allows reference to measurement or report objects, such as prior medical reports, laboratory results, hemodynamic measurement reports, or quantitative analysis reports.

**TID 3103  
Referenced Object  
Type: Extensible**

	NL	Relation with Parent	Value Type	Concept Name	VM	Req Type	Condition	Value Set Constraint
1			COMPOSITE	BCID (3407) Purpose of Reference to Object	1	M		
2	>	HAS PROPERTIES	CODE	EV (121144, DCM, "Document Title")	1	MC	IFF Row 1 references an SR object	Root node concept of referenced SR object
3	>		INCLUDE	DTID (3010) Log Entry Qualifiers	1	U		

**TID 3104 Consumables**

The Consumables Template allows recording of devices (e.g., catheters or stents), drugs, or contrast agents accessed in a procedure. This content item is directed towards inventory control and billing. The actual clinical use of the particular consumable is recorded using TID 3106 Drugs/Contrast Administered or TID 3107 Device Used.

This template allows recording both consumable retrieval from, and return to, inventory or stock, and disposal of used material. The quantity involved in each recorded transaction may be specified.

**TID 3104  
Consumables  
Type: Extensible**

	NL	Relation with Parent	Value Type	Concept Name	VM	Req Type	Condition	Value Set Constraint
1			CODE	DCID (3408) Actions with Consumables	1	M		Vendor or local bar coded values
2	>	HAS PROPERTIES	TEXT	DCID (3426) Consumables Parameters	1-n	U		
3	>	HAS PROPERTIES	NUM	EV (121146, DCM, "Quantity of Material")	1	U		
4	>	HAS PROPERTIES	CODE	EV (121147, DCM, "Billing Code")	1	U		local billing codes
5	>		INCLUDE	DTID (3010) Log Entry Qualifiers	1	U		

**TID 3105 Lesion Identification and Properties**

The Lesion Identification and Properties Template allows recording the identification of each lesion addressed in a procedure. The lesion identifier may be used to relate diagnostic or therapeutic actions with their target lesion (see Row 4 in TID 3010 Log Entry Qualifiers). This content item may include the initial visually estimated measurements of stenosis or TIMI flow; measured values from a quantitative measurement report may be referenced indirectly (through TID 3103 Referenced Object), or by quotation (TID 3109 Measurements template). Subsequent (e.g., post-intervention) stenosis measurements may be encoded using TID 3109 Measurements, with the Lesion Identifier conveyed through its subsidiary TID 3010 Log Entry Qualifiers template.

**TID 3105  
Lesion Identification and Properties  
Type: Extensible**

	NL	Relation with Parent	Value Type	Concept Name	VM	Req Type	Condition	Value Set Constraint
1			TEXT	EV (121151, DCM, "Lesion Identifier")	1	M		Up to 3 numeric characters
2	>	HAS PROPERTIES	CODE	EV (G-C0E3, SRT, "Finding Site")	1	M		DCID (3604) Arterial lesion locations
3	>>	HAS CONCEPT MOD	CODE	EV (G-A1F8, SRT, "Topographical modifier")	1	U		DCID (3019) Cardiovascular Anatomic Location Modifiers
4	>	HAS PROPERTIES	CODE	EV (121153, DCM, "Lesion Risk")	1	U		DCID (3418) Lesion Risk
5	>	HAS PROPERTIES	NUM	(R-101BB, SRT, "Lumen Diameter Stenosis")	1	U		UNITS = EV (% , UCUM, "%")
6	>>	HAS CONCEPT MOD	CODE	EV (G-72BB, SRT, "Catheterization Procedure Phase")	1	M		EV (G-7293, SRT, "Baseline Phase")

	NL	Relation with Parent	Value Type	Concept Name	VM	Req Type	Condition	Value Set Constraint
7	>>	HAS CONCEPT MOD	CODE	EV (121401, DCM, "Derivation")	1	U		DCID (3745) Calculation Method
8	>	HAS PROPERTIES	CODE	EV (122109, DCM, "Baseline TIMI Flow")	1	UC	IFF Row 2 specifies a coronary artery	DCID (3713) TIMI Flow Characteristics
9	>	HAS PROPERTIES	CODE	EV (122131, DCM, "Degree of Thrombus")	1	U		DCID (3714) Thrombus
10	>	HAS PROPERTIES	CODE	EV (F-01740, SRT, "Lesion Margin Characteristics")	1	U		DCID (3715) Lesion Margin
11	>	HAS PROPERTIES	CODE	EV (122134, DCM, "Vessel Morphology")	1-n	U		DCID (3712) Vessel Descriptors
12	>	HAS PROPERTIES	CODE	EV (122132, DCM, "Severity of Calcification")	1	U		DCID (3716) Severity
13	>	HAS PROPERTIES	IMAGE	DT (121080, DCM, "Best illustration of finding")	1	U		
14	>		INCLUDE	DTID (3010) Log Entry Qualifiers	1	U		

### Content Item Descriptions

Row 1 Lesion Identifier is specified as a numeric text string in order to facilitate transcoding to DICOM Attribute (0018,3105) Lesion Number and to formats for outcomes registries, such as the ACC National Cardiovascular Data Registry™.

### TID 3106 Drugs/Contrast Administered

The Drugs/Contrast Administered Template allows the recording of the start or end of that type of event, together with its parameters. If start and end are represented by a single log entry (e.g., for an injection), the concept name "Drug/contrast administered" shall be used.

#### TID 3106 Drugs/Contrast Administered Type: Extensible

	NL	Relation with Parent	Value Type	Concept Name	VM	Req Type	Condition	Value Set Constraint
1			CODE	DCID (3409) Administration of Drugs/Contrast	1	M		BCID (10) Interventional Drug, or BCID (12) Radiographic Contrast Agent
2	>	HAS PROPERTIES	TEXT	EV (121145, DCM, "Description of Material")	1	U		
3	>	HAS PROPERTIES	CODE	EV (G-C340, SRT, "Route of administration")	1	U		BCID (11) Route of Administration
4	>	HAS PROPERTIES	NUM	DCID (3410) Numeric Parameters of Drugs/Contrast	1-n	U		
5	>	HAS PROPERTIES	PNAME	EV (121152, DCM, "Person administering drug/contrast")	1	U		
6	>		INCLUDE	DTID (3010) Log Entry Qualifiers	1	U		

**TID 3107 Device Used**

The Device Used Template allows recording of the use of interventional diagnostic and therapeutic devices.

The identification of one device used to deploy another device (e.g., a balloon catheter to deploy a stent) may be described with two entries, with one identified as a deployment device in the Concept Modifier of Row 6 of this template, and linked by the same Procedure Action ID in the Log Entry Qualifiers of the included TID 3010.

**TID 3107  
Device Used  
Type: Extensible**

	NL	Relation with Parent	Value Type	Concept Name	VM	Req Type	Condition	Value Set Constraint
1			CODE	DCID (3422) Device Use Actions	1	M		BCID (3429) Catheterization Devices
2	>	HAS PROPERTIES	CODE	EV (121150, DCM, "Device Code")	1-n	U		Vendor or local bar coded values
3	>	HAS PROPERTIES	TEXT	EV (121145, DCM, "Description of Material")	1	U		
4	>	HAS PROPERTIES	NUM	DCID (3423) Numeric Device Characteristics	1-n	U		
5	>	HAS PROPERTIES	CODE	EV (G-C0E9, SRT, "Procedure site")	1	U		BCID (3630) Cardiovascular Anatomic Locations
6	>	HAS CONCEPT MOD	CODE	EV (G-C0E8, SRT, "Has Intent")	1	U		DT (121155, DCM, "Deployment")
7	>		INCLUDE	DTID (3010) Log Entry Qualifiers	1	U		

**TID 3108 Intervention**

The Intervention Template allows recording of interventions, including atherectomy, angioplasty, stent placement, brachytherapy, etc. The record may include reference to an image that documents the intervention.

**TID 3108  
Intervention  
Type: Extensible**

	NL	Relation with Parent	Value Type	Concept Name	VM	Req Type	Condition	Value Set Constraint
1			CODE	EV (122090, DCM, "Intervention Action")	1	M		DCID (3412) Intervention Actions and Status
2	>	HAS PROPERTIES	CODE	EV (G-C0E9, SRT, "Procedure site")	1	M		DCID (3604) Arterial Lesion Locations
3	>>	HAS CONCEPT MOD	CODE	EV (G-A1F8, SRT, "Topographical modifier")	1	U		DCID (3019) Cardiovascular Anatomic Location Modifiers
4	>	HAS PROPERTIES	TEXT	EV (121154, DCM, "Intervention attempt identifier")	1	M		Up to 3 numeric characters
5	>	HAS	CODE	EV (G-C50A, SRT, "Uses	1-n	U		BCID (3411)

	NL	Relation with Parent	Value Type	Concept Name	VM	Req Type	Condition	Value Set Constraint
		PROPERTIES		Equipment")				Intracoronary Devices
6	>>	HAS CONCEPT MOD	CODE	EV (122111, DCM, "Primary Intervention Device")	1	MC	IF Device is Primary for this Lesion	DCID (230) Yes-No
7	>	HAS PROPERTIES	NUM	DCID (3425) Intervention Parameters	1-n	U		
8	>	HAS PROPERTIES	IMAGE	BCID (7003) Diagnostic Imaging Report Purposes of Reference	1	U		
9	>		INCLUDE	DTID (3010) Log Entry Qualifiers	1	U		

### Content Item Descriptions

Row 4 Intervention attempt Identifier is specified as a numeric text string, and shall be treated as the ordinal of the recorded attempted intervention within this procedure (i.e., "1" for the first attempted intervention, "2" for the second, etc.).

### TID 3109 Measurements

The Measurements Template allows recording of significant measurements, such as vital signs, laboratory results, hemodynamic measurements, or quantitative analysis measurements. These measurements are often quoted from another source, which would be documented in the included TID 3010 Log Entry Qualifiers.

#### TID 3109 Measurements Type: Extensible

	NL	Relation with Parent	Value Type	Concept Name	VM	Req Type	Condition	Value Set Constraint
1			NUM	No BCID	1	U		
2	>		INCLUDE	DTID (3010) Log Entry Qualifiers	1	U		
3	>	HAS PROPERTIES	INCLUDE	DTID (310) Measurement Properties	1	U		
4			CODE	No BCID	1	U		
5	>		INCLUDE	DTID (3010) Log Entry Qualifiers	1	U		

### TID 3110 Impressions or Findings

The Impressions or Findings Template allows the recording of unconfirmed (provisional) impressions or findings noted during the procedure. It is not intended to convey the Cath Lab Clinical Report (the formal report from the performing physician), although it may be used (like any Procedure Log entry) for the subsequent construction of the Cath Lab Clinical Report.

A finding that is supported by a specific image frame may reference that image in the INFERRED FROM / IMAGE row of the included TID 3010 Log Entry Qualifiers template.



**TID 3110**  
**Impressions or Findings**  
**Type: Extensible**

	NL	Relation with Parent	Value Type	Concept Name	VM	Req Type	Condition	Value Set Constraint
1			CODE	EV (121071, DCM, "Finding")	1	U		BCID (3728) Cath Findings
2	>	HAS PROPERTIES	CODE	EV (G-C197, SRT, "Severity")	1	U		DCID (3716) Severity
4	>	HAS PROPERTIES	CODE	EV (G-C0E3, SRT, "Finding Site")	1	U		
5	>>	HAS CONCEPT MOD	CODE	EV (G-A1F8, SRT, "Topographical modifier")	1	U		DCID (3019) Cardio-vascular Anatomic Location Modifiers
6	>		INCLUDE	DTID (3010) Log Entry Qualifiers	1	U		
7			TEXT	BCID (3419) Findings Titles	1	U		
8	>		INCLUDE	DTID (3010) Log Entry Qualifiers	1	U		

**Content Item Descriptions**

Row 4 Finding Site has no Baseline Context ID specified. Typically terms would be drawn from coronary segments, other arterial segments, myocardial segments, etc.

**TID 3111 Percutaneous Entry**

The Percutaneous Entry Template allows recording of the opening or closing of invasive access ports.

**TID 3111**  
**Percutaneous Entry**  
**Type: Extensible**

	NL	Relation with Parent	Value Type	Concept Name	VM	Req Type	Condition	Value Set Constraint
1			CODE	EV (121156, DCM, "Percutaneous Entry Action")	1	M		DCID (3403) Percutaneous Entry
2	>	HAS CONCEPT MOD	CODE	EV (G-C171, SRT, "Laterality")	1	U		DCID (244) Laterality
3	>		INCLUDE	DTID (3010) Log Entry Qualifiers	1	U		

**TID 3112 Specimen Obtained**

The Specimen Obtained Template allows recording of obtaining a specimen, and the identifiers for that specimen. This is particularly designed for blood samples that will be analyzed for blood oxygen-related measurements. The analysis of the sample may be recorded in one or more log entries using TID 3109 Measurements Template, or in a separate Structured Report SOP Instance referenced by a log entry using TID 3103 Referenced Object Template.

**TID 3112**  
**Specimen Obtained**  
**Type: Extensible**

	NL	Relation with Parent	Value Type	Concept Name	VM	Req Type	Condition	Value Set Constraint
1			CODE	EV (121123, DCM, "Patient Status or Event")	1	M		DCID (3515) Specimen Collection
2	>	HAS ACQ CONTEXT	CODE	EV (121042, DCM, "Specimen Type")	1	UC	IFF specimen is blood sample	DCID (3520) Blood Source Type
3	>	HAS ACQ CONTEXT	CODE	EV (G-C0E9, SRT, "Procedure site")	1	U		BCID (3630) Cardiovascular Anatomic locations
4	>	HAS PROPERTIES	INCLUDE	DTID (1009) Subject Context, Specimen	1	U		

**TID 3113 Patient Support**

The Patient Support Template allows recording of the use of various support technologies, including oxygen, ventilation, pacing, etc.

**TID 3113**  
**Patient Support**  
**Type: Extensible**

	NL	Relation with Parent	Value Type	Concept Name	VM	Req Type	Condition	Value Set Constraint
1			CODE	DCID (3530) Oxygen Administration Actions	1	U		DCID (3531) Oxygen Administration
2	>	HAS PROPERTIES	NUM	EV (121160, DCM, "Oxygen Administration Rate")	1	MC	IFF Row 1 Concept is (121161, DCM, "Begin Oxygen Administration")	Units = DT (l/min, UCUM, "l/min")
3	>		INCLUDE	DTID (3010) Log Entry Qualifiers	1	U		
4			CODE	DCID (3550) Circulatory Support Actions	1	U		DCID (3553) Circulatory Support
5	>		INCLUDE	DTID (3010) Log Entry Qualifiers	1	U		
6			CODE	DCID (3551) Ventilation Actions	1	U		DCID (3554) Ventilation
7	>		INCLUDE	DTID (3010) Log Entry Qualifiers	1	U		
8			CODE	DCID (3552) Pacing Actions	1	U		DCID (3555) Pacing
9	>		INCLUDE	DTID (3010) Log Entry Qualifiers	1	U		

**TID 3114 Patient Assessment**

The Patient Assessment Template allows recording of the assessment of the patient's cardiovascular, neurological, and/or respiratory condition. A particular use of this template is for "vital signs", which are a specific subset of mandatory patient assessment measurements.

**TID 3114  
Patient Assessment  
Type: Extensible**

	NL	Relation with Parent	Value Type	Concept Name	VM	Req Type	Condition	Value Set Constraint
1			CODE	EV (121123, DCM, "Patient Status or Event")	1	M		DT (121165, DCM, "Patient Assessment Performed") or DT (PA-00500, SRT, "Observation of Vital Signs")
2	>	HAS PROPERTIES	INCLUDE	TID (300) Measurement	1	MC	IF Row 1 value = (PA-00500, SRT, "Observation of Vital Signs")	\$Measurement = EV (F-008EC, SRT, "Systolic blood pressure") \$Units = DCID (3500) \$Method = BCID (3560) Blood Pressure Methods
3	>	HAS PROPERTIES	INCLUDE	TID (300) Measurement	1	MC	IF Row 1 value = (PA-00500, SRT, "Observation of Vital Signs")	\$Measurement = EV (F-008ED, SRT, "Diastolic blood pressure") \$Units = DCID (3500)
4	>	HAS PROPERTIES	INCLUDE	TID (300) Measurement	1	MC	IF Row 1 value = (PA-00500, SRT, "Observation of Vital Signs")	\$Measurement = EV (8867-4, LN, "Heart rate") \$Units = EV ("{H.B.}/min", UCUM, "BPM")
5	>	HAS PROPERTIES	INCLUDE	TID (300) Measurement	1	MC	IF Row 1 value = (PA-00500, SRT, "Observation of Vital Signs")	\$Measurement = EV (8310-5, LN, "Body temperature") \$Units = EV (Cel, UCUM, "°C")
6	>	HAS PROPERTIES	INCLUDE	TID (300) Measurement	1	MC	IF Row 1 value = (PA-00500, SRT, "Observation of Vital Signs")	\$Measurement = DCID (3526) Blood gas saturation \$Units = EV (% , UCUM, "%")
7	>	HAS PROPERTIES	INCLUDE	TID (300) Measurement	1	MC	IF Row 1 value = (PA-00500, SRT, "Observation of Vital Signs")	\$Measurement = EV (F-043E7, SRT, "Respiration rate") \$Units = EV (/min, UCUM, "breaths/min")
8	>	HAS PROPERTIES	INCLUDE	TID (300) Measurement	1-n	MC	IF Row 1 value = (PA-00500, SRT, "Observation of Vital Signs")	\$Measurement = EV (122195, DCM, "Pulse Strength") \$Method = BCID (3442) Peripheral Pulse Methods \$TargetSite = BCID (3440) Peripheral Pulse Locations \$Units = DT ("{0:4}", UCUM, "range 0:4")
9	>	HAS PROPERTIES	INCLUDE	TID (300) Measurement	1	MC	IF Row 1 value = (PA-00500, SRT, "Observation of Vital Signs")	\$Measurement = EV (F-009EA, SRT, "Pain Score") \$Units = DT ("{1:10}", UCUM, "range 1:10")
10	>	HAS PROPERTIES	CODE	DT (8884-9, LN, "Cardiac Rhythm")	1	U		BCID (3415) Cardiac Rhythms
11	>	HAS PROPERTIES	CODE	DT (9304-7, LN, "Respiration Rhythm")	1	U		BCID (3416) Respiration Rhythms
12	>	HAS PROPERTIES	CODE	DT ( F-043E6, SRT, "Respiration Assessment")	1	U		BCID (3448) Airway Assessment

	NL	Relation with Parent	Value Type	Concept Name	VM	Req Type	Condition	Value Set Constraint
13	>	HAS PROPERTIES	CODE	DT (F-046D8, SRT, "Skin condition")	1-n	U		BCID (3446) Skin Condition
14	>	HAS PROPERTIES	CODE	DT (F-04317, "Patient mental state assessment")	1	U		No BCID
15	>	HAS PROPERTIES	TEXT	BCID (3441) Patient Assessments	1-n	U		

### Content Item Descriptions

Row 8 Pulse Strength allows the assessment of the patient's pulse at multiple locations using the Topographical concept modifier. It may also be used for a single pulse strength measurement from an unspecified location, as is typical of vital signs assessments.

Row 16 allows free text description of patient assessments that are not expressible by coded entries of Rows 10 to 14.

### TID 3115 ECG ST Assessment

The ECG ST Assessment Template allows recording of the assessment of changes in the patient ECG relative to baseline.

#### TID 3115 ECG ST Assessment Type: Extensible

	NL	Relation with Parent	Value Type	Concept Name	VM	Req Type	Condition	Value Set Constraint
1			CODE	EV (121123, DCM, "Patient Status or Event")	1	M		DT (R-41D8B, SRT, "ECG Analysis")
2	>	HAS PROPERTIES	NUM	DT (122099, DCM, "ST change from baseline")	1-n	M		Units = EV(uV, UCUM, "uV")
3	>>	HAS CONCEPT MOD	CODE	DT (122148, DCM, "Lead ID")	1	M		BCID (3001) ECG Leads

## QUANTITATIVE VENTRICULAR ANALYSIS REPORT SR IOD TEMPLATES

The templates that comprise the Quantitative Ventricular Analysis SR are interconnected as in Figure A-3:

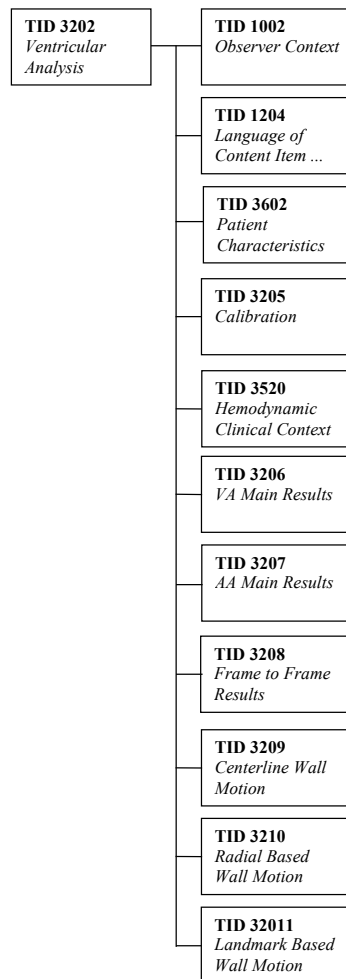

Figure A-3: Quantitative Ventricular Analysis Report SR IOD Template Structure

### TID 3202 Ventricular Analysis Template

The Ventricular Analysis Template provides a CONTAINER with a structure for reporting the result of the ventricular analysis.

### TID 3202 VENTRICULAR ANALYSIS Type: Extensible

	NL	Rel with Parent	VT	Concept Name	VM	Req Type	Condition	Value Set Constraint
1			CONTAINER	EV (122292, DCM, "Quantitative Ventriculography Report")	1	M		
2	>	HAS CONCEPT MOD	INCLUDE	DTID (1204) Language Of Content Item And Descendants	1	M		
3	>	HAS OBS	INCLUDE	DTID (1002) Observer	1-n	M		

NL	Rel with Parent	VT	Concept Name	VM	Req Type	Condition	Value Set Constraint
	CONTEXT		Context				
4 >	CONTAINS	INCLUDE	DTID (3602) Cardiovascular Patient Characteristics	1	U		
5 >	CONTAINS	CONTAINER	EV (122144, DCM, "Quantitative Analysis")	1-n	M		
6 >>	HAS OBS CONTEXT	INCLUDE	DTID (1002) Observer Context	1-n	U		
7 >>	HAS OBS CONTEXT	TEXT	EV (111001, DCM, "Algorithm Name")	1	M		
8 >>	HAS OBS CONTEXT	TEXT	EV (111003, DCM, "Algorithm Version")	1	M		
9 >>	HAS OBS CONTEXT	TEXT	EV (122405, DCM, "Algorithm Manufacturer")	1	M		
10 >>	CONTAINS	IMAGE	EV (121112, DCM, "Source of Measurements")	1-n	M		
11 >>>	HAS CONCEPT MOD	CODE	EV (G-A60B), SRT, "Cardiac Phase"	1	M		DCID (12233) Cardiac Phase
12 >>>	HAS CONCEPT MOD	CODE	EV (111031, DCM, "Image View")	1	MC	If Biplane Analysis	DCID (3466) Plane Identification
13 >>	HAS ACQ CONTEXT	INCLUDE	DTID (3205) Calibration	1-2	U	VM = 1: Single plane analysis, VM = 2: Biplane analysis	\$CalibrationPlane = DCID (3466) Plane Identification
14 >>	HAS ACQ CONTEXT	INCLUDE	DTID (3520) Hemodynamic Clinical Context	1	U		
15 >>	CONTAINS	INCLUDE	DTID (3206) VA Main Results	1	M		
16 >>	CONTAINS	INCLUDE	DTID (3207) AA Main Results	1	U		
17 >>	CONTAINS	INCLUDE	DTID (3208) Frame to Frame Results	1	U		
18 >>	CONTAINS	INCLUDE	DTID (3209) Centerline Wall Motion	1-2	U	VM = 1: Single plane analysis, VM = 2: Biplane analysis	
19 >>	CONTAINS	INCLUDE	DTID (3210) Radial Based Wall Motion	1-2	U	VM = 1: Single plane analysis, VM = 2: Biplane analysis	
20 >>	CONTAINS	INCLUDE	DTID (3211) Landmark Based Wall Motion	1-2	U	VM = 1: Single plane analysis, VM = 2: Biplane analysis	

### Content Item Descriptions

Row 7	Identifies the Ventricular Analysis program
Row 8	Identifies the Ventricular Analysis program version
Row 9	Identifies the Ventricular Analysis program manufacturer
Row 10	Identifies the ES and ED images on which the analysis is based, for frame by frame analysis the analyzed image are specified in the frame by frame results (3208) template

### TID 3205 Calibration Template

The Calibration Template consists of a CONTAINER, with a structure for reporting of the calibration of images used in the analysis.

Parameter Name	Parameter Usage
\$CalibrationPlane	XA Imaging plane

### TID 3205 CALIBRATION Type: Extensible

NL	Rel with Parent	VT	Concept Name	VM	Req Type	Condition	Value Set Constraint
1		CONTAINER	EV (122505, DCM, "Calibration")	1	M		
2 >	HAS CONCEPT MOD	CODE	EV (111031, DCM, "Image View")	1	U		\$CalibrationPlane
3 >	HAS OBS CONTEXT	TEXT	EV (111001, DCM, "Algorithm Name")	1	MC	If different from Analysis program specified in the invoking template	
4 >	HAS OBS CONTEXT	TEXT	EV (111003, DCM, "Algorithm Version")	1	MC	If different from Analysis program specified in the invoking template	
5 >	HAS OBS CONTEXT	TEXT	EV (122405, DCM, "Algorithm Manufacturer")	1	MC	If different from Analysis program specified in the invoking template	
6 >	CONTAINS	CODE	EV (122422, DCM, "Calibration Method")	1	M		DCID (3452) Calibration Methods
7 >	CONTAINS	CODE	EV (122421, DCM, "Calibration Object")	1	MC	If row 6 value specifies Calibration Object Used	DCID (3451) Calibration Object
8 >	CONTAINS	NUM	EV (122423, DCM, "Calibration Object Size")	1	MC	If row 6 value specifies Calibration Object Used	DCID (3510) Catheter Size Units
9 >	CONTAINS	INCLUDE	DTID (300) Measurement	1	M		\$Measurement = EV (111026, DCM, "Horizontal Pixel Spacing") \$Unit = DT (mm/{pixel}, UCUM, "mm/pixel") \$ImagePurpose = EV (121112, DCM, "Source of Measurement")
10 >	CONTAINS	INCLUDE	DTID (300) Measurement	1	M		\$Measurement = EV (111066, DCM, "Vertical Pixel Spacing") \$Unit = DT (mm/{pixel}, UCUM, "mm/pixel") \$ImagePurpose = EV (121112, DCM, "Source of Measurements")
11 >	CONTAINS	IMAGE	No purpose of reference	1	U		

### Content Item Descriptions

Row 3	Identifies the Calibration program
Row 4	Identifies the Calibration program version
Row 5	Identifies the Calibration program manufacturer
Row 7	Besides a Sphere and a Catheter, a Distance can be identified as a Calibration Object. In this case a distance measurement of a known dimension of the object is used to calculate the pixel size.
Row 8	The catheter size units is also used to specify the size of other calibration objects (e.g. sphere)
Row 9,10	Spacing in the patient body. Point to a single frame containing the image used for calibration if applicable, the actual measurements may be indicated by a SCOOD (see TID 320, row 3)
Row 11	Secondary Capture image with calibration position

### TID 3206 VA Main Results Template

The VA Main Results Template consists of a CONTAINER with a structure for reporting the main ventricular analysis measurements.

### TID 3206 VA MAIN RESULTS Type: Extensible

NL	Rel with Parent	VT	Concept Name	VM	Req Type	Condition	Value Set Constraint
1		CONTAINER	EV (121070, DCM, "Findings")	1	M		

NL	Rel with Parent	VT	Concept Name	VM	Req Type	Condition	Value Set Constraint
2 >	HAS CONCEPT MOD	CODE	EV (G-C0E3, SRT, "Finding Site")	1	M		DCID (3462) Chamber Identification
3 >	CONTAINS	CODE	EV (122429, DCM, "Volume Method")	1	M		DCID (3453) Volume Methods
4 >	CONTAINS	NUM	EV (122435, DCM, "Regression Volume Exponent")	1	U		Unit = DT (1, UCUM, "no units")
5 >	CONTAINS	NUM	EV (122431, DCM, "Regression Slope ED")	1	U		Unit = DT (1, UCUM, "ratio")
6 >	CONTAINS	NUM	EV (122432, DCM, "Regression Offset ED")	1	U		Unit = DT (ml, UCUM, "ml")
7 >	CONTAINS	NUM	EV (122433, DCM, "Regression Slope ES")	1	U		Unit = DT (1, UCUM, "ratio")
8 >	CONTAINS	NUM	EV (122434, DCM, "Regression Offset ES")	1	U		Unit = DT (ml, UCUM, "ml")
9 >	CONTAINS	INCLUDE	DTID (300) Measurement	1	M		\$Measurement = DCID (3467) Ejection Fraction \$Unit = DT (% , UCUM, "%")
10 >	CONTAINS	INCLUDE	DTID (300) Measurement	1	U		\$Measurement = DCID (3468) ED Volume \$Unit = DT (ml, UCUM, "ml")
11 >	CONTAINS	INCLUDE	DTID (300) Measurement	1	U		\$Measurement = DCID (3469) ES Volume \$Unit = DT (ml, UCUM, "ml")
12 >	CONTAINS	INCLUDE	DTID (300) Measurement	1	U		\$Measurement = EV (20562-5, LN, "Stroke Volume") \$Unit = DT (ml, UCUM, "ml")
13 >	CONTAINS	NUM	EV (8867-4, LN, "Heart Rate")	1	U		Unit = DT (hb)/min, UCUM, "beats/min")
14 >	CONTAINS	INCLUDE	DTID (300) Measurement	1	U		\$Measurement = DCID (3468) ED Volume \$ModType = EV (121425, DCM, "Index") \$ModValue = DCID (3455) Index Methods \$Unit = DT (ml/m <sup>2</sup> , UCUM, "ml/m^ 2")
15 >	CONTAINS	INCLUDE	DTID (300) Measurement	1	U		\$Measurement = DCID (3468) ED Volume \$ModType = EV (121425, DCM, "Index") \$ModValue = EV (29463-7. LN, "Patient Weight") \$Unit = DT (ml/kg, UCUM, "ml/kg")
16 >	CONTAINS	INCLUDE	DTID (300) Measurement	1	U		\$Measurement = DCID (3469) ES Volume \$ModType = EV (121425, DCM, "Index") \$ModValue = DCID (3455) Index Methods \$Unit = DT (ml/m <sup>2</sup> , UCUM, "ml/m^2")
17 >	CONTAINS	INCLUDE	DTID (300) Measurement	1	U		\$Measurement = DCID (3469) ES Volume \$ModType = EV (121425, DCM, "Index")



NL	Rel with Parent	VT	Concept Name	VM	Req Type	Condition	Value Set Constraint
							\$ModValue = EV (29463-7. LN, "Patient Weight") \$Unit = DT (ml/kg, UCUM, "ml/kg")
18	>	CONTAINS	INCLUDE	DTID (300) Measurement	1	U	\$Measurement = EV (20562-5, LN, "Stroke Volume") \$ModType = EV (121425, DCM, "Index") \$ModValue = DCID (3455) Index Methods \$Unit = DT (ml/m2, UCUM, "ml/m^2")
19	>	CONTAINS	INCLUDE	DTID (300) Measurement	1	U	\$Measurement = EV (20562-5, LN, "Stroke Volume") \$ModType = EV (121425, DCM, "Index") \$ModValue = EV (29463-7. LN, "Patient Weight") \$Unit = DT (ml/kg, UCUM, "ml/kg")
20	>	CONTAINS	INCLUDE	DTID (300) Measurement	1	U	\$Measurement = EV (F-32100, SRT, "Cardiac Output") \$Unit = DT (l/min, UCUM, "l/min")
21	>	CONTAINS	INCLUDE	DTID (300) Measurement	1	U	\$Measurement = EV (F-32110, SRT, "Cardiac Index") \$ModType = EV (121425, DCM, "Index") \$ModValue = DCID (3455) Index Methods \$Unit = DT (l/min/m2, UCUM, "l/min/m^2")
22	>	CONTAINS	INCLUDE	DTID (300) Measurement	1	U	\$Measurement = EV (122445, DCM, "Wall Thickness") \$Unit = DT (mm, UCUM, "mm")
23	>	CONTAINS	INCLUDE	DTID (300) Measurement	1	U	\$Measurement = EV (122446, DCM, "Wall Volume") \$Unit = DT (ml, UCUM, "ml")
24	>	CONTAINS	INCLUDE	DTID (300) Measurement	1	U	\$Measurement = EV (122447, DCM, "Wall Mass") \$Unit = DT (g, UCUM, "gram")
25	>	CONTAINS	INCLUDE	DTID (300) Measurement	1	U	\$Measurement = EV (122447, DCM, "Wall Mass") \$ModType = EV (121425, DCM, "Index") \$ModValue = DCID (3455) Index Methods \$Unit = DT (g/m2, UCUM, "gram/m^2")
26	>	CONTAINS	INCLUDE	DTID (300) Measurement	1	U	\$Measurement = EV (122447, DCM, "Wall Mass") \$ModType = EV (121425, DCM, "Index") \$ModValue = EV (29463-7. LN, "Patient Weight") \$Unit = DT (g/kg, UCUM, "gram/kg")
27	>	CONTAINS	INCLUDE	DTID (300) Measurement	1	U	\$Measurement = EV (122448,

NL	Rel with Parent	VT	Concept Name	VM	Req Type	Condition	Value Set Constraint
							DCM, "Wall Stress") \$Unit = DT (dyn/cm2, UCUM, "dynes/cm^2")
28 >	CONTAINS	IMAGE	No purpose of reference	1-n	U		

**Content Item Descriptions**

Row 28	Secondary Capture image with ED and/or ES contours
--------	--

**TID 3207 AA Main Results Template**

The AA Main Results Template consists of a CONTAINER with a structure for reporting the main atrial analysis measurements.

**TID 3207  
AA MAIN RESULTS  
Type: Extensible**

NL	Rel with Parent	VT	Concept Name	VM	Req Type	Condition	Value Set Constraint
1		CONTAINER	EV (121070, DCM, "Findings")	1	M		
2 >	HAS CONCEPT MOD	CODE	EV (G-C0E3, SRT, "Finding Site")	1	M		DCID (3462) Chamber Identification
3 >	CONTAINS	CODE	EV (122429, DCM, "Volume Method")	1	M		DCID (3453) Volume Methods
4 >	CONTAINS	NUM	EV (122435, DCM, "Regression Volume Exponent")	1	U		Unit = DT (1, UCUM, "no units")
5 >	CONTAINS	NUM	EV (122431, DCM, "Regression Slope ED")	1	U		Unit = DT (1, UCUM, "ratio")
6 >	CONTAINS	NUM	EV (122432, DCM, "Regression Offset ED")	1	U		Unit = DT (ml, UCUM, "ml")
7 >	CONTAINS	NUM	EV (122433, DCM, "Regression Slope ES")	1	U		Unit = DT (1, UCUM, "ratio")
8 >	CONTAINS	NUM	EV (122434, DCM, "Regression Offset ES")	1	U		Unit = DT (ml, UCUM, "ml")
9 >	CONTAINS	INCLUDE	DTID (300) Measurement	1	U		\$Measurement = DCID (3468) ED Volume \$Unit = DT (ml, UCUM, "ml")
10 >	CONTAINS	INCLUDE	DTID (300) Measurement	1	U		\$Measurement = DCID (3469) ES Volume \$Unit = DT (ml, UCUM, "ml")
11 >	CONTAINS	IMAGE	No purpose of reference	1-n	U		

**Content Item Descriptions**

Row 11	Secondary Capture image with ED and/or ES contours
--------	--

**TID 3208 Frame-to-Frame Results Template**

The Frame-to-Frame Result Template consists of a CONTAINER providing measurements derived from the angiographic images on frame-by-frame basis.

**TID 3208**  
**FRAME-TO-FRAME RESULT**  
**Type: Extensible**

NL	Rel with Parent	VT	Concept Name	VM	Req Type	Condition	Value Set Constraint
1		CONTAINER	EV (121070, DCM, "Findings")	1	M		
2 >	HAS CONCEPT MOD	CODE	EV (111004, DCM, "Analysis Performed")	1	M		EV (122499, DCM, "Frame to Frame Analysis")
3 >	CONTAINS	IMAGE	EV (121112, DCM, "Source of Measurements")	1-2	M	VM = 1: Single plane analysis, VM = 2: Biplane analysis	
4 >	CONTAINS	CODE	EV (122429, DCM, "Volume Method")	1	M		DCID (3453) Volume Methods
5 >	CONTAINS	INCLUDE	DTID (300) Measurement	n	M		\$Measurement = DCID (3471) Estimated Volumes \$TargetSite = DCID (3462) Chamber Identification \$Unit = DT (ml, UCUM, "ml")
6 >	CONTAINS	INCLUDE	DTID (300) Measurement	n	U		\$Measurement = EV (122445, DCM, "Wall Thickness") \$Unit = DT (mm, UCUM, "mm")
7 >	CONTAINS	IMAGE	No purpose of reference	1-n	U		

**Content Item Descriptions**

Row 3	Identifies each frame analyzed, using the multi-valued Referenced Frame Number (0008,1160) attribute of the IMAGE content item.
Row 5,6	Includes one measurement for each frame referenced in Row 3.
Row 7	Secondary Capture image with ventricular contours

**TID 3209 Centerline Wall Motion Template**

The Centerline Wall Motion Template consists of a CONTAINER providing measurements of the centerline wall motion.

**TID 3209**  
**CENTERLINE WALL MOTION**  
**Type: Extensible**

NL	Rel with Parent	VT	Concept Name	VM	Req Type	Condition	Value Set Constraint
1		CONTAINER	EV (121070, DCM, "Findings")	1	M		
2 >	HAS CONCEPT MOD	CODE	EV (111004, DCM, "Analysis Performed")	1	M		EV (122449, DCM, "Centerline Wall Motion Analysis")
3 >>	HAS CONCEPT MOD	CODE	EV (122410, DCM, "Contour Realignment")	1	M		DCID (3458) Contour Realignment
4 >	CONTAINS	INCLUDE	DTID (300) Measurement	100	M		\$Measurement = EV (122450, DCM, "Normalized Chord Length") \$Unit = DT (% , UCUM, "%")
5 >	CONTAINS	NUM	EV (122411, DCM, "Threshold Value")	1	M		Values shall be 1, 2 or 3 Units = EV ({sd}, UCUM, "Standard Deviations")
6 >	CONTAINS	CONTAINER	EV (122451, DCM, "Abnormal Region")	1-6	U		

NL	Rel with Parent	VT	Concept Name	VM	Req Type	Condition	Value Set Constraint
7 >>	CONTAINS	CODE	EV (F-32050, SRT, "Cardiac Wall Motion")	1	M		DCID (3703) Wall Motion
8 >>	CONTAINS	CODE	EV (R-404F0, SRT, "Circumferential Extent")	1	U		DCID (3460) Circumferential Extent
9 >>	CONTAINS	NUM	EV (122452, DCM, "First Chord of Abnormal Region")	1	M		Unit = DT (1, UCUM, "no unit")
10 >>	CONTAINS	NUM	EV (122453, DCM, "Last Chord of Abnormal Region")	1	M		Unit = DT (1, UCUM, "no unit")
11 >	CONTAINS	CONTAINER	EV (122417, DCM, "Regional Abnormal Wall Motion")	1-4	U		
12 >>	HAS CONCEPT MOD	CODE	EV (G-C03E, SRT, "Finding Site")	1	M		DCID (3461) Regional Extent
13 >>	CONTAINS	INCLUDE	DTID (300) Measurement	1	M		\$Measurement = EV (122459, DCM, "Territory Region Severity") \$ModType = EV (F-32050, SRT, "Cardiac Wall Motion") \$ModValue = DCID (3703) Wall Motion \$Unit = DT ({sd}, UCUM, "Standard Deviations")
14 >>	CONTAINS	INCLUDE	DTID (300) Measurement	1	M		\$Measurement = EV (122461, DCM, "Opposite Region Severity") \$ModType = EV (F-32050, SRT, "Cardiac Wall Motion") \$ModValue = DCID (3703) Wall Motion \$Unit = DT ({sd}, UCUM, "Standard Deviations")
15 >	CONTAINS	IMAGE	No purpose of reference	1	U		

### Content Item Descriptions

Row 4	Normalized lengths of the chords determined between ED and ES contour. The measurement template allows the specification of the statistical properties of the normal population and of the chord measurement relative to the population.
Row 8	If the Circumferential Extent is not specified no limitations to the boundaries for regions are assumed.
Row 11	The Regional Abnormal Wall Motion container holds the information on the severity of the decreased or increased wall motion of the 4 predefined regions as described in [Sheehan, 1986].
Row 12	The name of the region with an abnormal ventricular wall motion as described in [Sheehan, 1986].
Row 13	The severity of the wall motion abnormality expressed in Standard Deviations above or below normal in the territory region as described in [Sheehan, 1986].
Row 14	The severity of the wall motion abnormality expressed in Standard Deviations above or below normal in the opposite region as described in [Sheehan, 1986].
Row 15	Secondary Capture image with centerline analysis result

### TID 3210 Radial Based Wall Motion Template

The Radial Based Wall Motion Template consists of a CONTAINER providing measurements of the radial based wall motion.

### TID 3210 RADIAL BASED WALL MOTION Type: Extensible

NL	Rel with Parent	VT	Concept Name	VM	Req Type	Condition	Value Set Constraint
1		CONTAINER	EV (121070, DCM, "Findings")	1	M		
2 >	HAS CONCEPT MOD	CODE	EV (111004, DCM, "Analysis Performed")	1	M		EV (122493, DCM, "Radial Based Wall Motion Analysis")
3 >>	HAS CONCEPT MOD	CODE	EV (122410, DCM, "Contour Realignment")	1	M		DCID (3458) Contour Realignment
4 >	CONTAINS	CONTAINER	EV (121070, DCM, "Findings")	1-n	M		
5 >>	HAS CONCEPT MOD	CODE	EV (G-C0E3, SRT, "Finding Site")	1	M		DCID (3718) Myocardial Wall Segments in Projection
6 >>	CONTAINS	INCLUDE	DTID (300) Measurement	1	M		\$Measurement = EV (122495, DCM, "Regional Contribution to Ejection Fraction") \$Unit = DT (% , UCUM, "%")
7 >>	CONTAINS	INCLUDE	DTID (300) Measurement	1-n	U		\$Measurement = EV (122496, DCM, "Radial Shortening") \$Unit = DT (% , UCUM, "%")
8 >	CONTAINS	IMAGE	No purpose of reference	1	U		

### Content Item Descriptions

Row 6	The CREF values of the 6 regions determined for the radial based wall motion
Row 7	The shortening of the measured radials within the region
Row 8	Secondary Capture image with radial based analysis result

### TID 3211 Landmark Based Wall Motion Template

The Landmark Based Wall Motion Template consists of a CONTAINER providing measurements of the landmark based wall motion.

### TID 3211 LANDMARK BASED WALL MOTION Type: Extensible

NL	Rel with Parent	VT	Concept Name	VM	Req Type	Condition	Value Set Constraint
1		CONTAINER	EV (121070, DCM, "Findings")	1	M		
2 >	HAS CONCEPT MOD	CODE	EV (111004, DCM, "Analysis Performed")	1	M		EV (122497, DCM, "Landmark Based Wall Motion Analysis")
3 >>	HAS CONCEPT MOD	CODE	EV (122410, DCM, "Contour Realignment")	1	M		DCID (3458) Contour Realignment
4 >	CONTAINS	INCLUDE	DTID (300) Measurement	1-n	M		\$Measurement = EV (122498, DCM, "Slice Contribution to Ejection Fraction") \$Unit = DT (% , UCUM, "%")
5 >	CONTAINS	CONTAINER	EV (121070, DCM, "Findings")	5	M		
6 >>	HAS CONCEPT MOD	CODE	EV (G-C0E3, SRT, "Finding Sites")	1	M		DCID (3718) Myocardial Wall Segments in Projection
7 >	CONTAINS	INCLUDE	DTID (300) Measurement	1	M		\$Measurement = EV (122495, DCM, "Regional Contribution to Ejection Fraction") \$Unit = DT (% , UCUM, "%")

	NL	Rel with Parent	VT	Concept Name	VM	Req Type	Condition	Value Set Constraint
8 >		CONTAINS	IMAGE	No purpose of reference	1	U		

**Content Item Descriptions**

Row 8	Secondary Capture image with Landmark Based Analysis result
-------	---

## QUANTITATIVE ARTERIAL ANALYSIS REPORT SR IOD TEMPLATES

The templates that comprise the Quantitative Arterial Analysis SR are interconnected as in Figure A-4:

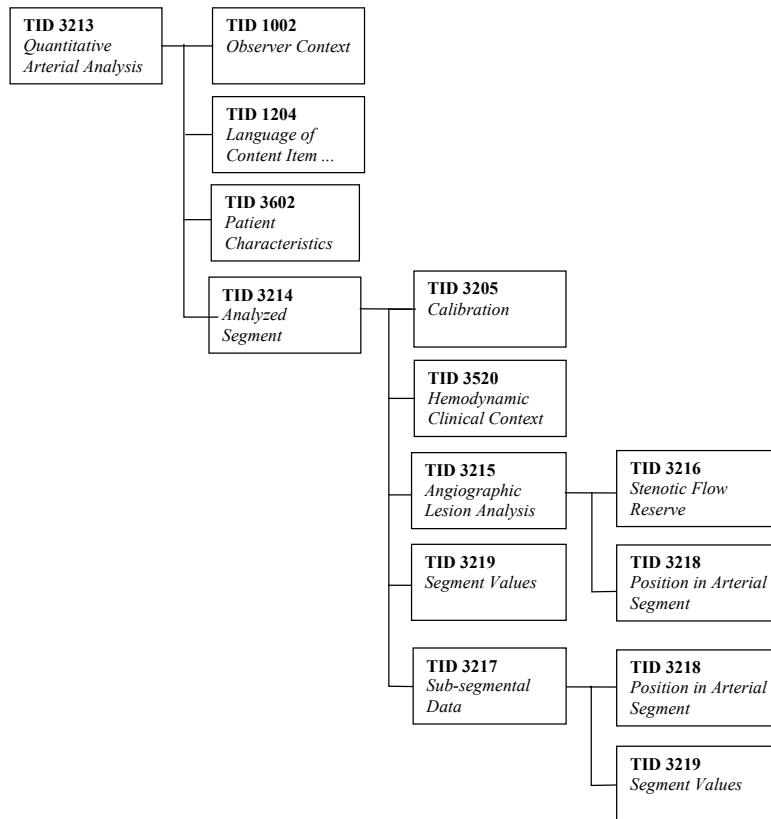

Figure A-4: Quantitative Arterial Analysis Report SR IOD Template Structure

### TID 3213 Quantitative Arterial Analysis Template

The Quantitative Arterial Analysis Template consists of a CONTAINER with a structure for reporting the result of the quantitative arterial analysis process.

#### TID 3213 QUANTITATIVE ARTERIAL ANALYSIS Type: Extensible

NL	Rel with Parent	VT	Concept Name	VM	Req Type	Condition	Value Set Constraint
1		CONTAINER	EV (122291, DCM, "Quantitative Arteriography Report")	1	M		
2	> HAS CONCEPT MOD	INCLUDE	DTID (1204) Language Of Content Item And Descendants	1	M		
3	> HAS OBS CONTEXT	INCLUDE	DTID (1002) Observer Context	1-n	M		
4	> CONTAINS	INCLUDE	DTID (3602) Cardiovascular Patient Characteristics	1	U		
5	> HAS OBS CONTEXT	TEXT	EV (111001, DCM, "Algorithm Name")	1	M		

	NL	Rel with Parent	VT	Concept Name	VM	Req Type	Condition	Value Set Constraint
6 >		HAS OBS CONTEXT	TEXT	EV (111003, DCM, "Algorithm Version")	1	M		
7 >		HAS OBS CONTEXT	TEXT	EV (122405, DCM, "Algorithm Manufacturer")	1	M		
8 >		CONTAINS	INCLUDE	DTID (3214) Analyzed Segment	1-n	M		

**Content Item Descriptions**

Row 5	Identifies the Arterial Analysis program
Row 6	Identifies the Arterial Analysis program version
Row 7	Identifies the Arterial Analysis program manufacturer

**TID 3214 Analyzed Segment Template**

The Analyzed Segment Template consists of a CONTAINER providing quantitative arterial analysis measurements derived from the angiographic images.

**TID 3214  
ANALYZED SEGMENT  
Type: Extensible**

	NL	Rel with Parent	VT	Concept Name	VM	Req Type	Condition	Value Set Constraint
1			CONTAINER	EV (121070, DCM, "Findings")	1	M		
2 >		HAS CONCEPT MOD	CODE	EV (G-C0E3, SRT, "Finding Site")	1	M		DCID (3604) Arterial lesion locations
3 >		CONTAINS	IMAGE	EV (121112, DCM, "Source of Measurements")	1	M		
4 >		CONTAINS	INCLUDE	DTID (3205) Calibration	1	M		
5 >		HAS ACQ CONTEXT	INCLUDE	DTID (3520) Hemodynamic Clinical Context	1	U		
6 >		CONTAINS	SCoord	EV (122507, DCM, "Left Contour")	1	M		GRAPHIC TYPE = POLYLINE
7 >>		R-SELECTED FROM	IMAGE		1	M		Must reference Row 3
8 >		CONTAINS	SCoord	EV (122508, DCM, "Right Contour")	1	M		GRAPHIC TYPE = POLYLINE
9 >>		R-SELECTED FROM	IMAGE		1	M		Must reference Row 3
10 >		CONTAINS	INCLUDE	DTID (3219) Segment Values	1	M		
11 >		CONTAINS	INCLUDE	DTID (300) Measurement	1	M		\$Measurement = EV (G-0364, SRT, "Vessel Luminal Diameter") \$Derivation = (R-404FB, SRT, "Minimum") \$Unit = DT (mm, UCUM, "mm")
12 >		CONTAINS	INCLUDE	DTID (300) Measurement	1	M		\$Measurement = EV (G-0364, SRT, "Vessel Luminal Diameter") \$Derivation = (G-A437, SRT, "Maximum") \$Unit = DT (mm, UCUM, "mm")
13 >		CONTAINS	CONTAINER	EV (122509, DCM, "Diameter Graph")	1	U		
14 >>		CONTAINS	NUM	EV (122511, DCM, "Graph Increment")	1	M		Value = 1 Units = DT ({pixels}, UCUM,



NL	Rel with Parent	VT	Concept Name	VM	Req Type	Condition	Value Set Constraint
							"pixels")
15 >>	CONTAINS	INCLUDE	DTID (300) Measurement	1-n	M		\$Measurement = EV (G-0364, SRT, "Vessel Luminal Diameter") \$Unit = DT (mm, UCUM, "mm")
16 >	CONTAINS	NUM	EV (122382, DCM, "Site of Luminal Minimum ")	1	U		Units = DT ({pixels}, UCUM, "pixels")
17 >	CONTAINS	NUM	EV (122516, DCM, "Site of Luminal Maximum")	1	U		Units = DT ({pixels}, UCUM, "pixels")
18 >	CONTAINS	INCLUDE	DTID (3215) Angiographic Lesion Analysis	1-n	U		
19 >	CONTAINS	INCLUDE	DTID (3217) Sub-Segmental Data	1-n	U		
20 >	CONTAINS	IMAGE	No purpose of reference	1	U		

### Content Item Descriptions

Row 1	Observation DateTime (0040,A032) of container needs to be flagged with the time of the analysis
Row 6	Numeric coordinates (x,y) identifying the contour points from proximal to distal of left contour. Left is relative to the direction of the blood flow.
Row 8	Numeric coordinates (x,y) identifying the contour points from proximal to distal of right contour. Right is relative to the direction of the blood flow.
Row 11,12	Positions are relative to the midpoint between the first left and right contour points and measured along the midline between the left and right contour.
Row 13	The X-axis represents the pixel points of the midline of the vessel from proximal to distal. The points on the midline are not necessarily equidistant.
Row 15	For each point of the midline of the vessel a measurement value for the diameter is calculated.
Row 16,17	The positions in the graph are related to the points on the midline of the vessel.
Row 20	Secondary Capture image with Arterial Analysis contour.

Definition of Left and Right defined by the direction of the blood flow:

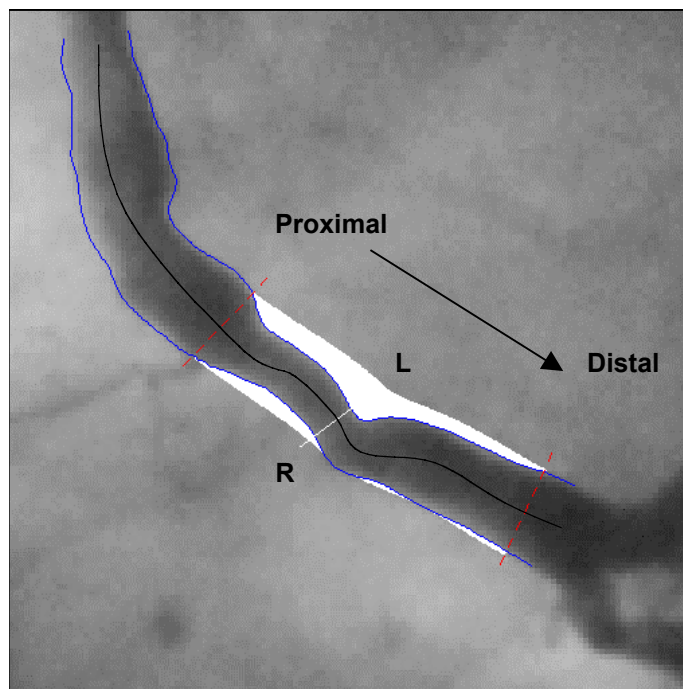

**TID 3215      Angiographic Lesion Analysis Template**

The Angiographic Lesion Analysis Template consists of a CONTAINER providing quantitative arterial analysis measurements derived for an obstruction in a total analyzed segment.

**TID 3215  
ANGIOGRAPHIC LESION ANALYSIS  
Type: Extensible**

	NL	Rel with Parent	VT	Concept Name	VM	Req Type	Condition	Value Set Constraint
1			CONTAINER	EV (F-00585, SRT, "Lesion Finding")	1	M		
2	>	CONTAINS	TEXT	EV (121151, DCM, "Lesion Identifier")	1	M		
3	>>	HAS PROPERTIES	CODE	EV (G-C0E3, SRT, "Finding Site")	1	M		DCID (3604) Arterial lesion locations
4	>>>	HAS CONCEPT MOD	CODE	EV (G-A1F8, SRT, "Topographical modifier")	1	U		DCID (3019) Cardio-vascular Anatomic Location Modifiers
5	>	CONTAINS	INCLUDE	DTID (300) Measurement	1	M		\$Measurement = EV (G-0364, SRT, "Vessel Luminal Diameter") \$Derivation =(R-404FB, SRT, "Minimum") \$Unit = DT (mm, UCUM, "mm")
6	>	CONTAINS	INCLUDE	DTID (300) Measurement	1-n	U		\$Measurement = EV (G-0366, SRT, "Vessel Lumen Cross-Sectional Area") \$Method = DCID (3470) Vessel Lumen Cross-Sectional Area Calculation Methods \$Derivation =(R-404FB, SRT, "Minimum") \$Unit = DT (mm <sup>2</sup> , UCUM, "mm <sup>2</sup> ")
7	>	CONTAINS	CODE	EV (122430, DCM, "Reference Method")	1	M		DCID (3465) QA Reference Method
8	>	CONTAINS	CONTAINER	EV (122438, DCM, "Reference Points")	1	U		
9	>>	CONTAINS	NUM	EV (122337, DCM, "Relative Position")	1-n	M		\$Unit = DT (mm, UCUM, "mm")
10	>>>	HAS PROPERTIES	INCLUDE	DTID (300) Measurement	1	U		\$Measurement = EV (G-0364, SRT, "Vessel Luminal Diameter") \$Unit = DT (mm, UCUM, "mm")
11	>	CONTAINS	INCLUDE	DTID (300) Measurement	1	M		\$Measurement = EV (G-0364, SRT, "Vessel Luminal Diameter") \$TargetSite = (122382, DCM, "Site of Luminal Minimum") \$Unit = DT (mm, UCUM, "mm")
12	>	CONTAINS	INCLUDE	DTID (300) Measurement	1	U		\$Measurement = EV (G-0366, SRT, "Vessel Lumen Cross-Sectional Area") \$Derivation = EV (122404, DCM, "Reconstructed") \$TargetSite = (122382, DCM, "Site of Luminal Minimum") \$Unit = DT (mm <sup>2</sup> , UCUM, "mm <sup>2</sup> ")

	NL	Rel with Parent	VT	Concept Name	VM	Req Type	Condition	Value Set Constraint
13	>	CONTAINS	INCLUDE	DTID (300) Measurement	1	M		\$Measurement = EV (G-0364, SRT, "Vessel Luminal Diameter") \$Derivation = EV (R-41D2D, SRT, "Calculated") \$TargetSite = EV (122481, DCM, "Contour Start") \$Unit = DT (mm, UCUM, "mm")
14	>	CONTAINS	INCLUDE	DTID (300) Measurement	1	M		\$Measurement = EV (G-0364, SRT, "Vessel Luminal Diameter") \$Derivation = EV (R-41D2D, SRT, "Calculated") \$TargetSite = EV (122482, DCM, "Contour End") \$Unit = DT (mm, UCUM, "mm")
15	>	CONTAINS	INCLUDE	DTID (3218) Position in Arterial Segment	1	M		
16	>	CONTAINS	CONTAINER	EV (122517, DCM, "Densitometric Luminal Cross-sectional Area Graph")	1	U		
17	>>	CONTAINS	NUM	EV (122511, DCM, "Graph Increment")	1	M		Value = 1 Units = DT ({pixels}, UCUM, "pixels")
18	>>	CONTAINS	INCLUDE	DTID (300) Measurement	1-n	M		\$Measurement = EV (G-0366, SRT, "Vessel Lumen Cross-Sectional Area") \$Unit = (mm <sup>2</sup> , UCUM, "mm <sup>2</sup> ")
19	>	CONTAINS	INCLUDE	DTID (300) Measurement	1	U		\$Measurement = EV (G-0366, SRT, "Vessel Lumen Cross-Sectional Area") \$Derivation = EV (R-41D2D, SRT, "Calculated") \$Method = EV(122474, DCM, "Densitometric method") \$TargetSite = EV (122481, DCM, "Contour Start") \$Unit = (mm <sup>2</sup> , UCUM, "mm <sup>2</sup> ")
20	>	CONTAINS	INCLUDE	DTID (300) Measurement	1	U		\$Measurement = EV (G-0366, SRT, "Vessel Lumen Cross-Sectional Area") \$Derivation = EV (R-41D2D, SRT, "Calculated") \$Method = EV(122474, DCM, "Densitometric method") \$TargetSite = EV (122482, DCM, "Contour End") \$Unit = (mm <sup>2</sup> , UCUM, "mm <sup>2</sup> ")
21	>	CONTAINS	INCLUDE	DTID (300) Measurement	1	M		\$Measurement = EV (R-101BC, SRT, "Lesion Length") \$Unit = DT (mm, UCUM, "mm")
22	>	CONTAINS	INCLUDE	DTID (300) Measurement	1	M		\$Measurement = EV (R-101BB, SRT, "Lumen Diameter Stenosis") \$Unit = DT (% , UCUM, "%")
23	>	CONTAINS	INCLUDE	DTID (300) Measurement	1-n	U		\$Measurement = EV (R-101BA, SRT, "Lumen Area Stenosis") \$Method = DCID (3470) Vessel Lumen Cross-Sectional Area Calculation Methods

NL	Rel with Parent	VT	Concept Name	VM	Req Type	Condition	Value Set Constraint
							\$Unit = DT (% , UCUM, "%")
24 >	CONTAINS	INCLUDE	DTID (300) Measurement	1-n	U		\$Measurement = EV (122372, DCM, "Lumen Volume") \$Method = DCID (3470) Vessel Lumen Cross-Sectional Area Calculation Methods \$Unit = DT (mm3, UCUM, "mm^3")
25 >	CONTAINS	INCLUDE	DTID (300) Measurement	1	U		\$Measurement = EV (122542, DCM, "Plaque Area") \$Unit = DT (mm2, UCUM, "mm^2")
26 >	CONTAINS	INCLUDE	DTID (300) Measurement	1	U		\$Measurement = EV (122376, DCM, "Total Plaque Volume") \$Unit = DT (mm3, UCUM, "mm^3")
27 >	CONTAINS	INCLUDE	DTID (300) Measurement	1	U		\$Measurement = EV (122544, DCM, "Diameter Symmetry") \$Unit = DT ({ratio}, UCUM, "ratio")
28 >	CONTAINS	INCLUDE	DTID (300) Measurement	1	U		\$Measurement = EV (122545, DCM, "Area Symmetry") \$Unit = DT ({ratio}, UCUM, "ratio")
29 >	CONTAINS	INCLUDE	DTID (300) Measurement	1	U		\$Measurement = EV (122546, DCM, "Inflow Angle") \$Unit = DT (deg, UCUM, "degrees")
30 >	CONTAINS	INCLUDE	DTID (300) Measurement	1	U		\$Measurement = EV (122547, DCM, "Outflow Angle") \$Unit = DT (deg, UCUM, "degrees")
31 >	CONTAINS	INCLUDE	DTID (3216) Stenotic Flow Reserve	1	U		
32 >	CONTAINS	IMAGE	No purpose of reference	1	U		

### Content Item Descriptions

Row 8	Set of user defined reference position for method that requires local reference position.
Row 9	Distance of local reference position from an arbitrary landmark.
Row 10	Diameter at a local reference position.
Row 11	The reference diameter for the arterial lesion calculated with the applicable reference method
Row 12	The reference area for the arterial lesion calculated with the applicable reference method
Row 13	The diameter measurement at the start of the reconstruction line in the diameter graph (TID 3214 Row 13)
Row 14	The diameter measurement at the end of the reconstruction line in the diameter graph (TID 3214 Row 13)
Row 15	The positions of the lesion, borders of the lesion, etc.
Row 16	The graph with the calculated cross sectional area results based on the densitometric method
Row 18	The cross sectional area measurements calculated based on the densitometric method
Row 19	The cross sectional area measurement at the start of the reconstruction line in the area graph
Row 20	The cross sectional area measurement at the end of the reconstruction line in the area graph
Row 21	Measured along the midline of the left and right contour
Row 22	The diameter stenosis is calculated as follows: (Reference Luminal Diameter – Minimum Luminal Diameter / Reference Luminal Diameter) * 100%
Row 23	The circular and the densitometric area stenosis are calculated respectively as: (Reference Vessel Lumen Cross-Sectional Area – Minimum Luminal Circular Area / Reference Vessel

	Lumen Cross-Sectional Area) * 100% (Reference Vessel Lumen Cross-Sectional Area – Minimum Luminal Densitometric Area / Reference Vessel Lumen Cross-Sectional Area) * 100%
Row 24	Estimated lumen volume between proximal border and distal border of lesion (TID 3218, row 1 and 2)
Row 32	Secondary Capture image with obstruction analysis contour

**TID 3216 Stenotic Flow Reserve Template**

The Stenotic Flow Reserve Template consists of a CONTAINER providing quantitative arterial analysis measurements derived for an obstruction in a total analyzed segment.

**TID 3216  
STENOTIC FLOW RESERVE  
Type: Extensible**

NL	Rel with Parent	VT	Concept Name	VM	Req Type	Condition	Value Set Constraint
1	CONTAINS	INCLUDE	DTID (300) Measurement	1	M		\$Measurement = EV (122548, DCM, "Stenotic Flow Reserve") \$Unit = DT (ratio), UCUM, "ratio")
2	CONTAINS	INCLUDE	DTID (300) Measurement	1	M		\$Measurement = EV (122549, DCM, "Poiseuille Resistance") \$Unit = DT (mm[Hg]/cm, UCUM, "mmHg/cm")
3	CONTAINS	INCLUDE	DTID (300) Measurement	1	M		\$Measurement = EV (122550, DCM, "Turbulence Resistance") \$Unit = DT (mm[Hg]s <sup>2</sup> /cm <sup>2</sup> , UCUM, "mmHg <sup>2</sup> /cm <sup>2</sup> ")
4	CONTAINS	INCLUDE	DTID (300) Measurement	1	M		\$Measurement = EV (122555, DCM, "Estimated Normal Flow") \$Unit = DT (ml/s, UCUM, "ml/s")
5	CONTAINS	INCLUDE	DTID (300) Measurement	1	U		\$Measurement = EV (122551, DCM, "Pressure Drop at SFR") \$Unit = DT (mm[Hg], UCUM, "mmHg")
6	CONTAINS	IMAGE	No purpose of reference	1	U		

**Content Item Descriptions**

Row 6	Secondary Capture image with SFR analysis contour
-------	---

**TID 3217 Sub-segmental Data Template**

The Sub-segmental Data Template consists of a CONTAINER providing quantitative arterial analysis measurements derived for a sub-segment in a total analyzed segment.

**TID 3217  
SUB-SEGMENTAL DATA  
Type: Extensible**

NL	Rel with Parent	VT	Concept Name	VM	Req Type	Condition	Value Set Constraint
1		CONTAINER	EV (121070, DCM, "Findings")	1	M		
2 >	HAS CONCEPT MOD	CODE	EV (G-C0E3, SRT, "Finding Site")	1	M		DCID (3604) Arterial lesion locations
3 >>	HAS	CODE	EV (G-A1F8, SRT,	1	U		DCID (3019) Cardio-vascular

NL	Rel with Parent	VT	Concept Name	VM	Req Type	Condition	Value Set Constraint
	CONCEPT MOD		"Topographical modifier")				Anatomic Location Modifiers
4 >	CONTAINS	CODE	EV (122554, DCM, "Segmentation Method")	1	M		DCID (3456) Sub-segment Methods
5 >	CONTAINS	INCLUDE	DTID (3219) Segment Values	1	U		
6 >	CONTAINS	INCLUDE	DTID (3218) Position in Arterial Segment	1	M		
7 >	CONTAINS	IMAGE	No purpose of reference	1	U		

**Content Item Descriptions**

Row 7	Secondary Capture image with obstruction analysis contour
-------	---

**TID 3218 Position in Arterial Segment**

The Position in Arterial Segment Template consists of the position content items common for the Angiographic Lesion Analysis and Sub-Segmental Data.

**TID 3218  
POSITION IN ARTERIAL SEGMENT  
Type: Extensible**

NL	Rel with Parent	VT	Concept Name	VM	Req Type	Condition	Value Set Constraint
1	CONTAINS	INCLUDE	DTID (300) Measurement	1	M		\$Measurement = EV (122528, DCM, "Position of Proximal Border") \$Unit = DT (mm, UCUM, "mm")
2	CONTAINS	INCLUDE	DTID (300) Measurement	1	M		\$Measurement = EV (122529, DCM, "Position of Distal Border") \$Unit = DT (mm, UCUM, "mm")
3	CONTAINS	INCLUDE	DTID (300) Measurement	1	M		\$Measurement = EV (122382, DCM, "Site of Luminal Minimum") \$Unit = DT (mm, UCUM, "mm")
4	CONTAINS	INCLUDE	DTID (300) Measurement	1	M		\$Measurement = EV (122516, DCM, "Site of Luminal Maximum") \$Unit = DT (mm, UCUM, "mm")
5	CONTAINS	NUM	EV (122528, DCM, "Position of Proximal Border")	1	UC	IFF TID 3214 Row 13 is present	Units = DT ({pixels}, UCUM, "pixels")
6	CONTAINS	NUM	EV (122529, DCM, "Position of Distal Border")	1	UC	IFF TID 3214 Row 13 is present	Units = DT ({pixels}, UCUM, "pixels")
7	CONTAINS	NUM	EV (122382, DCM, "Site of Luminal Minimum")	1	UC	IFF TID 3214 Row 13 is present	Units = DT ({pixels}, UCUM, "pixels")
8	CONTAINS	NUM	EV (122516, DCM, "Site of Luminal Maximum")	1	UC	IFF TID 3214 Row 13 is present	Units = DT ({pixels}, UCUM, "pixels")

**Content Item Descriptions**

Row 1,2,3,4	Positions are relative to the midpoint of the first left and right contour points and measured along the midline of the left and right contour
Row 5,6,7,8	The positions are relative to the measurement locations of the Diameter Graph of TID 3214 row 13.

**TID 3219 Segment Values Template**

The Segment Values Template consists of content items providing quantitative arterial analysis measurements for a total analyzed segment or sub segment.

**TID 3219  
SEGMENT VALUES  
Type: Extensible**

NL	Rel with Parent	VT	Concept Name	VM	Req Type	Condition	Value Set Constraint
1	CONTAINS	INCLUDE	DTID (300) Measurement	1	M		\$Measurement = EV (122510, DCM, "Length Luminal Segment") \$Unit = DT (mm, UCUM, "mm")
2	CONTAINS	INCLUDE	DTID (300) Measurement	1	M		\$Measurement = EV (G-0364, SRT, "Vessel Luminal Diameter") \$Derivation = (R-404FB, SRT, "Minimum") \$Unit = DT (mm, UCUM, "mm")
3	CONTAINS	INCLUDE	DTID (300) Measurement	1	M		\$Measurement = EV (G-0364, SRT, "Vessel Luminal Diameter") \$Derivation =(G-A437, SRT, "Maximum") \$Unit = DT (mm, UCUM, "mm")
4	CONTAINS	INCLUDE	DTID (300) Measurement	1	M		\$Measurement = EV (G-0364, SRT, "Vessel Luminal Diameter") \$Derivation = (R-00317, SRT, "Mean") \$Unit = DT (mm, UCUM, "mm")
5	CONTAINS	INCLUDE	DTID (300) Measurement	1	U		\$Measurement = EV (G-0364, SRT, "Vessel Luminal Diameter") \$Derivation = (R-10047, SRT, "Standard Deviation") \$Unit = DT (mm, UCUM, "mm")

**Content Item Descriptions**

Row 1	Measured along the midline of the left and right contour.
-------	---

### IVUS REPORT TEMPLATES

The templates that comprise the IVUS Report within the Evidence Report IOD are interconnected as shown in Figure A-5.

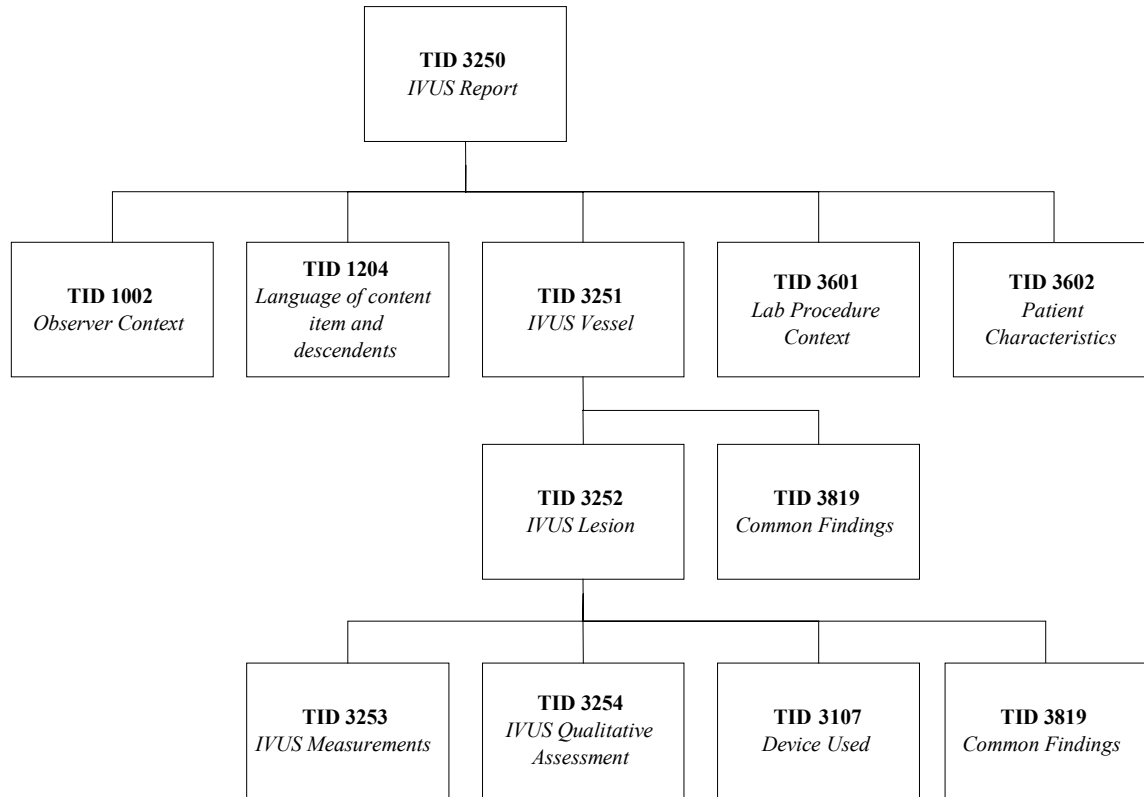

Figure A-5 IVUS Report Template Hierarchy



**TID 3250 IVUS Report**

The IVUS Report template is the root structure for the representation of IVUS measurements acquired during a catheterization procedure.

**TID 3250  
IVUS Report  
Type: Extensible**

	NL	Relation with Parent	Value Type	Concept Name	VM	Req Type	Condition	Value Set Constraint
1			CONTAINER	EV (122325, DCM, "IVUS Report")	1	M		
2	>	CONTAINS	INCLUDE	DTID (1204) Language of content item and descendents	1	M		
3	>	HAS OBS CONTEXT	INCLUDE	DTID (1002) Observer Context	1-n	U		
4	>	HAS OBS CONTEXT	INCLUDE	DTID (3601) Lab Procedure Context	1	U		
5	>	HAS ACQ CONTEXT	INCLUDE	DTID (3602) Cardiovascular Patient Characteristics	1	U		
6	>	CONTAINS	CONTAINER	EV (111028, DCM, "Image Library")	1	U		
7	>>	CONTAINS	IMAGE	No purpose of reference	1-n	U		
8	>	CONTAINS	INCLUDE	DTID (3251) IVUS Vessel	1-n	M		

**TID 3251 IVUS Vessel**

The IVUS Vessel template provides a structure for grouping one or more lesions analyzed and/or treated during a single phase of a catheterization procedure, according to vessel (or arterial location).

**TID 3251  
IVUS Vessel  
Type: Extensible**

	NL	Relation with Parent	Value Type	Concept Name	VM	Req Type	Condition	Value Set Constraint
1			CONTAINER	EV (121070, DCM, "Findings")	1	M		
2	>	HAS CONCEPT MOD	CODE	EV (G-C0E3, SRT, "Finding Site")	1	U		DCID (3604) Arterial Locations
3	>>	HAS CONCEPT MOD	CODE	EV (G-A1F8, SRT, "Topographical modifier")	1	U		DCID (3019) Cardiovascular Anatomic Location Modifiers
4	>>	HAS CONCEPT MOD	CODE	EV (G-C171, SRT, "Laterality")	1	UC	IFF anatomy has laterality	DCID (244) Laterality
5	>	HAS ACQ CONTEXT	CODE	EV (G-72BB, SRT, "Catheterization Procedure Phase")	1	U		DCID (3480) IVUS Procedure Phases
6	>	CONTAINS	CODE	EV (122134, DCM, "Vessel Morphology")	1-n	U		CID (3712) Vessel Descriptors
7	>	CONTAINS	INCLUDE	DTID (3819 ) Common Findings	1-n	U		
8	>	CONTAINS	CODE	EV (115, NCDR [2.0b], "Dissection in segment")	1	U		DCID (230) Yes-No
9	>	CONTAINS	INCLUDE	DTID (3252) IVUS Lesion	1-n	U		

**TID 3252 IVUS Lesion**

The IVUS Lesion template provides a structure for grouping measurements and observations made on a single lesion during an Intravascular Ultrasound Procedure.

**TID 3252  
IVUS Lesion  
Type: Extensible**

	NL	Relation with Parent	Value Type	Concept Name	VM	Req Type	Condition	Value Set Constraint
1			CONTAINER	EV (F-00585, SRT, "Lesion Finding")	1	M		
2	>	HAS OBS CONTEXT	TEXT	EV (121151, DCM, "Lesion Identifier")	1	M		Up to 3 numeric characters
3	>>	HAS CONCEPT MOD	CODE	EV (G-C0E3, SRT, "Finding Site")	1-n	U		DCID (3604) Arterial lesion locations
4	>>>	HAS CONCEPT MOD	CODE	EV (G-A1F8, SRT, "Topographical modifier")	1	U		DCID (3019) Cardio-vascular Anatomic Location Modifiers
5	>	HAS ACQ CONTEXT	INCLUDE	DTID (3107) Device Used	1-n	U		
6	>	CONTAINS	INCLUDE	DTID (3253) IVUS Measurements	1	MC	One or both of rows 6 & 7 must be present	
7	>	CONTAINS	INCLUDE	DTID (3254) IVUS Qualitative Assessment	1	MC	One or both of rows 6 & 7 must be present	
8	>	CONTAINS	INCLUDE	DTID( 3819) Common Findings	1-n	U		

**Content Item Descriptions**

Row 2 Lesion Identifier is specified as a numeric text string in order to facilitate trans-coding to DICOM Attribute (0018,3105) Lesion Number and to formats for outcomes registries, such as the ACC National Cardiovascular Data Registry™.

Note: Also see TID 3105.

Row 3 - Finding site may span multiple segments with the proximal and distal extent specified by separate items. These may not be totally contained with the segment specified at the Vessel level.

**TID 3253 IVUS Measurements**

The IVUS measurements template groups together simple distance, area and angle measurements, along with derived measurements that made during an IVUS procedure. Refer to the "ACC Clinical Expert Consensus Document on Standards for Acquisition, measurement and Reporting of Intravascular Ultrasound Studies (IVUS)" for more information.

**TID 3253  
IVUS Measurements  
Type: Extensible**

	NL	Relation with Parent	Value Type	Concept Name	VM	Req Type	Condition	Value Set Constraint
1			INCLUDE	TID (300) Measurement	1-n	U		\$Measurement = DCID (3481) IVUS Distance Measurements \$Units = EV (mm, UCUM, "mm")

	NL	Relation with Parent	Value Type	Concept Name	VM	Req Type	Condition	Value Set Constraint
								\$Derivation = DCID (3488) Min/Max/Mean \$TargetSite = BCID (3486) Vascular Measurement Sites
2			INCLUDE	TID (300) Measurement	1-n	U		\$Measurement = DCID (3482) IVUS Area Measurements \$Units = EV (mm2, UCUM, "mm2") \$Derivation = DCID (3488) Min/Max/Mean \$TargetSite = BCID (3486) Vascular Measurement Sites
3			INCLUDE	TID (300) Measurement	1-n	U		\$Measurement = DCID (3483) IVUS Longitudinal Measurements \$Units = EV (mm, UCUM, "mm")
4			INCLUDE	TID (300) Measurement	1-n	U		\$Measurement = EV (122355, DCM, "Arc of Calcium") \$Units = EV (deg, UCUM,"degrees") \$TargetSite = BCID (3486) Vascular Measurement Sites
5			INCLUDE	TID (300) Measurement	1	U		\$Measurement = EV (R-101BA, SRT, "Lumen Area Stenosis") \$Units = EV (% , UCUM, "%")
6			INCLUDE	TID (300) Measurement	1	U		\$Measurement = EV (122354, DCM, "Plaque Burden") \$Units = EV (% , UCUM, "%") \$TargetSite = BCID (3486) Vascular Measurement Sites
7			INCLUDE	TID (300) Measurement	1-n	U		\$Measurement = DCID (3484) IVUS Indices and Ratios \$Units = EV (1, UCUM, "ratio") \$TargetSite = BCID (3486) Vascular Measurement Sites
8			INCLUDE	TID (3255) IVUS Volume Measurement	1-n	U		
9			INCLUDE	TID (300) Measurement	1	U		\$Measurement = EV (122339, DCM, "Stent Volume Obstruction") \$Units = EV (% , UCUM, "%")

**TID 3254 IVUS Qualitative Assessments**

The IVUS Qualitative Assessments template groups together the qualitative properties of a lesion that are observed during an IVUS procedure. Refer to the “ACC Clinical Expert Consensus Document on Standards for Acquisition, measurement and Reporting of Intravascular Ultrasound Studies (IVUS)” for more information.

**TID 3254  
IVUS Qualitative Assessments  
Type: Extensible**

	NL	Relation with Parent	Value Type	Concept Name	VM	Req Type	Condition	Value Set Constraint
1			CODE	EV (122133, DCM, "Lesion Morphology")	1-n	U		DCID (3491) IVUS Lesion Morphologies
2			CODE	EV (121071, DCM, "Finding")	1-n	U		DCID (3494) IVUS Non Morphological Findings

	NL	Relation with Parent	Value Type	Concept Name	VM	Req Type	Condition	Value Set Constraint
3	>		INCLUDE	DTID (1350) "Negation Modifier, Presence of Finding"	1	U		
4			CODE	EV (121071, DCM, "Finding")	1	U		EV (D3-81310, SRT, "Arterial Dissection")
5	>	HAS CONCEPT MOD	CODE	EV (122387, DCM, "Dissection Classification")	1	U		DCID (3492) Vascular Dissection Classifications
6	>		INCLUDE	DTID (1350) "Negation Modifier, Presence of Finding"	1	U		
7			CODE	EV (122391, DCM, "Relative Stenosis Severity")	1	U		DCID (3493) IVUS Relative Stenosis Severities
8			CODE	EV (108, NCDR [2.0b], "Previously Dilated Lesion ")	1	U		DCID (3750) Previously Dilated Lesion
9			CODE	EV (121071, DCM, "Finding")	1	U		EV (122393, DCM, "Restenotic Lesion")
10	>		INCLUDE	DTID (1350) "Negation Modifier, Presence of Finding"	1	U		
11			CODE	EV (111009, "Calcification Type")	1	U		DCID (3489) Calcium Distribution

**TID 3255 IVUS Volume Measurement**

The IVUS Volume Measurement Template contains information describing an IVUS Volumetric measurement

**TID 3255  
IVUS Volume Measurement  
Type: Extensible**

	NL	Relation with Parent	Value Type	Concept Name	VM	Req Type	Condition	Value Set Constraint
1			INCLUDE	TID (300) Measurement	1	M		\$Measurement = DCID (3485) IVUS Volume Measurements \$Units = EV (mm3, UCUM, "mm3") \$TargetSite = BCID (3487) IVUS Volumetric Regions
2	>	HAS PROPERTIES	NUM	EV (122336, DCM, "Vascular Volume measurement length")	1	U		\$Unit = DT (mm, UCUM, "mm")
3	>	HAS PROPERTIES	NUM	EV (122337, DCM, "Relative position")	1	U		\$Unit = DT (mm, UCUM, "mm")
4	>>	HAS CONCEPT MOD	CODE	EV (122340, DCM, "Fiducial feature")	1	M		DCID (3496) IVUS Fiducial Points

## HEMODYNAMICS REPORT TEMPLATES

The templates that comprise the Hemodynamic Report are interconnected as shown in Figure A-6.

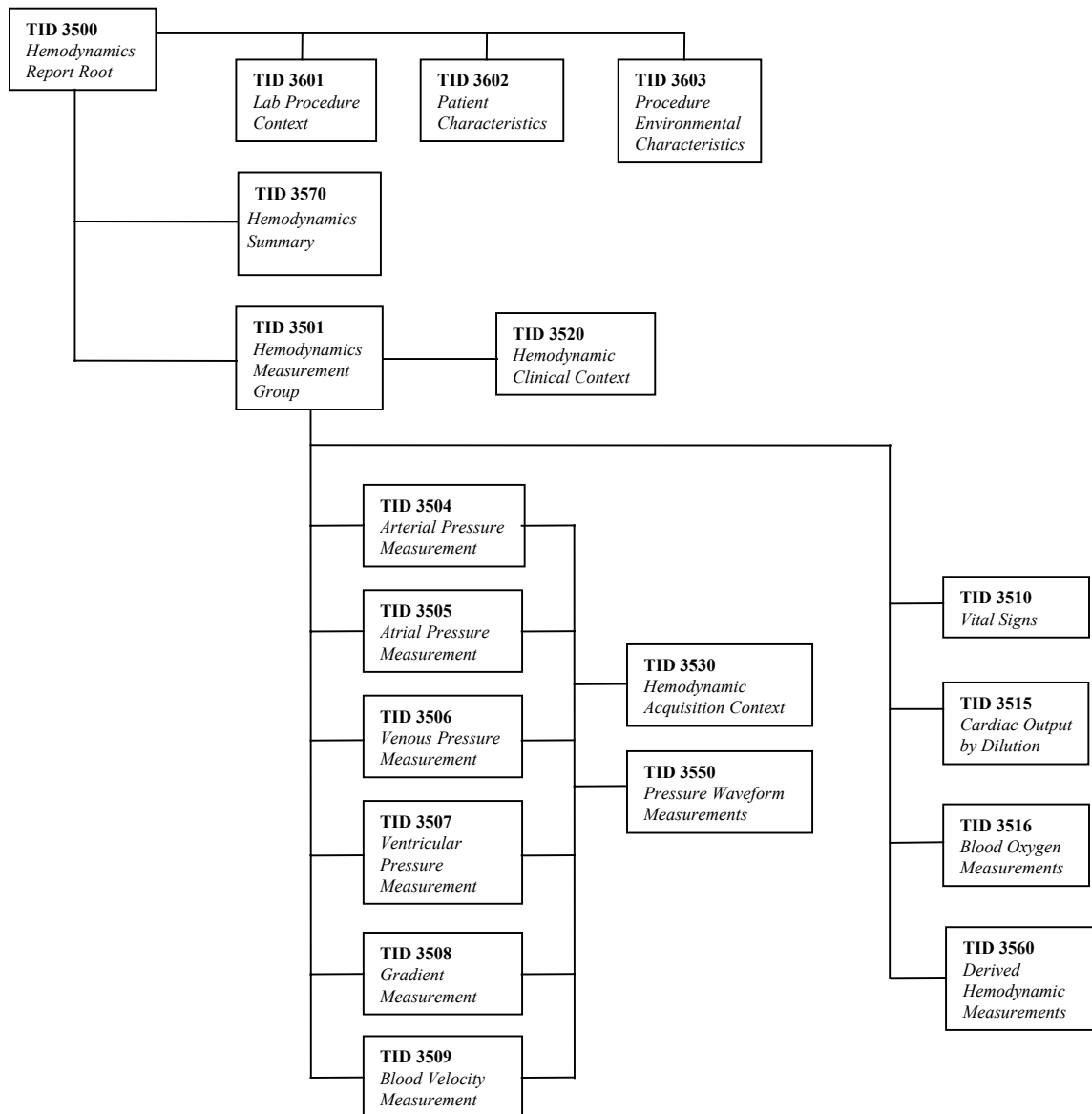

**Figure A-6 Hemodynamic Report Template Hierarchy**

The figure shows only the use of templates specific to the Hemodynamic Report; it does not show common structural templates such as TID 300.

Note: The figure shows the relationship of templates; it does not show the structural hierarchy of Content Items in the IOD. See PS 3.17.

**TID 3500 Hemodynamics Report**

The Hemodynamic Report template is the root structure for the representation of measurements acquired during a procedure in a cardiac catheterization lab.

**TID 3500  
Hemodynamics Report  
Type: Extensible**

	NL	Relation with Parent	Value Type	Concept Name	VM	Req Type	Condition	Value Set Constraint
1			CONTAINER	EV (122120, DCM, "Hemodynamics Report")	1	M		
2	>	HAS OBS CONTEXT	INCLUDE	DTID (1002) Observer Context	1-n	M		
3	>		INCLUDE	DTID (3601) Procedure Context	1	M		
4	>	HAS OBS CONTEXT	INCLUDE	DTID (3602) Cardiovascular Patient Characteristics	1	M		
5	>	HAS ACQ CONTEXT	INCLUDE	DTID (3603) Procedure Environmental Characteristics	1	U		
6	>	CONTAINS	INCLUDE	DTID (3501) Hemodynamic Measurement Group	1-n	M		
7	>	CONTAINS	INCLUDE	DTID (3570) "Summary, Hemodynamics"	1	U		

**TID 3501 Hemodynamics Measurement Group**

The Hemodynamic Measurement Group template provides a structure for measurements acquired during a single procedure phase in a cardiac catheterization lab.

**TID 3501  
Hemodynamics Measurement Group  
Type: Extensible**

	NL	Relation with Parent	Value Type	Concept Name	VM	Req Type	Condition	Value Set Constraint
1			CONTAINER	DCID (3651) Hemodynamic Measurement phase	1	M		
2	>	HAS ACQ CONTEXT	INCLUDE	DTID (3520) Hemodynamic Clinical Context	1	U		
3	>	HAS ACQ CONTEXT	TEXT	EV (121124, DCM, "Procedure Action ID")	1	U		
4	>	CONTAINS	INCLUDE	DTID (3510) Vital signs	1-n	U		
5	>	CONTAINS	INCLUDE	DTID (3504) Arterial Pressure Measurement	1-n	U		
6	>	CONTAINS	INCLUDE	DTID (3505) Atrial Pressure Measurement	1-n	U		
7	>	CONTAINS	INCLUDE	DTID (3506) Venous Pressure Measurement	1-n	U		
8	>	CONTAINS	INCLUDE	DTID (3507) Ventricular Pressure Measurement	1-n	U		
9	>	CONTAINS	INCLUDE	DTID (3508) Gradient Measurement	1-n	U		
10	>	CONTAINS	INCLUDE	DTID (3509) Blood Velocity Measurements	1-n	U		

	NL	Relation with Parent	Value Type	Concept Name	VM	Req Type	Condition	Value Set Constraint
11	>	CONTAINS	INCLUDE	DTID (3515) Cardiac Output Measurement by Indicator Dilution	1-n	U		
12	>	CONTAINS	INCLUDE	DTID (3516) Blood lab measurements	1-n	U		
13	>	CONTAINS	INCLUDE	DTID (3560) Derived Hemodynamic Measurements	1-n	U		

### Content Item Descriptions

Row 3 Procedure Action ID allows linkage between the hemodynamic measurements recorded in this Template and a procedure step or phase recorded in the Procedure Log, e.g., using TID 3100.

### TID 3504 Arterial Pressure Measurement

The Arterial Pressure Measurement template consists of a CONTAINER, with an acquisition context of the measurement anatomic site, and containing systolic, diastolic, and mean measurements. This implies that the name of the measurement is effectively post-coordinated from the measurement name, the Hemodynamic Measurement Group container (procedure phase) name, and the acquisition context (finding site) value.

### TID 3504 Arterial Pressure Measurement Type: Extensible

	NL	Relation with Parent	Value Type	Concept Name	VM	Req Type	Condition	Value Set Constraint
1			CONTAINER	EV (P2-36102, SRT, "Arterial pressure measurements")	1	M		
2	>		INCLUDE	DTID (3530) Hemodynamic Acquisition Context	1	M		\$LocationName = EV (G-C0E3, SRT, "Finding Site") \$LocationValue = DCID (3606) Arterial source locations
3	>	CONTAINS	INCLUDE	DTID (300) Measurement	1	M		\$Measurement = EV (8480-6, LN, "Intravascular arterial Systolic pressure") \$Units = DCID (3500) Pressure Units
4	>	CONTAINS	INCLUDE	DTID (300) Measurement	1	M		\$Measurement = EV (8462-4, LN, "Intravascular arterial Diastolic pressure") \$Units = DCID (3500) Pressure Units
5	>	CONTAINS	INCLUDE	DTID (300) Measurement	1	M		\$Measurement = EV (8478-0, LN, "Intravascular arterial mean pressure") \$Units = DCID (3500) Pressure Units

	NL	Relation with Parent	Value Type	Concept Name	VM	Req Type	Condition	Value Set Constraint
6	>	CONTAINS	INCLUDE	DTID (3550) Pressure waveform measurements	1-n	U		

**TID 3505 Atrial Pressure Measurement**

The Atrial Pressure Measurement template consists of a CONTAINER, with an acquisition context of the measurement anatomic site, and containing a-wave, v-wave, and mean measurements. This implies that the name of the measurement is effectively post-coordinated from the measurement name, the Hemodynamic Measurement Group container (procedure phase) name, and the acquisition context (finding site) value.

**TID 3505  
Atrial Pressure Measurement  
Type: Extensible**

	NL	Relation with Parent	Value Type	Concept Name	VM	Req Type	Condition	Value Set Constraint
1			CONTAINER	EV (122121, DCM, "Atrial pressure measurements")	1	M		
2	>		INCLUDE	DTID (3530) Hemodynamic Acquisition Context	1	M		\$LocationName = EV (G-C0E3, SRT, "Finding Site") \$LocationValue = DCID (3608) Atrial source locations
3	>	CONTAINS	INCLUDE	DTID (300) Measurement	1	M		\$Measurement = EV (109016, DCM, "A-wave peak pressure") \$Units = DCID (3500) Pressure Units
4	>	CONTAINS	INCLUDE	DTID (300) Measurement	1	M		\$Measurement = EV (109034, DCM, "V-wave peak pressure") \$Units = DCID (3500) Pressure Units
5	>	CONTAINS	INCLUDE	DTID (300) Measurement	1	M		\$Measurement = EV (F 31150, SRT, "Mean blood pressure") \$Units = DCID (3500) Pressure Units
6	>	CONTAINS	INCLUDE	DTID (3550) Pressure waveform measurements	1-n	U		



**TID 3506 Venous Pressure Measurement**

The Venous Pressure Measurement template consists of a CONTAINER, with an acquisition context of the measurement anatomic site, and containing a mean measurement. This implies that the name of the measurement is effectively post-coordinated from the measurement name, the Hemodynamic Measurement Group container (procedure phase) name, and the acquisition context (finding site) value.

**TID 3506  
Venous Pressure Measurement  
Type: Extensible**

	NL	Relation with Parent	Value Type	Concept Name	VM	Req Type	Condition	Value Set Constraint
1			CONTAINER	EV (P2-36110, SRT, "Venous pressure measurements")	1	M		
2	>		INCLUDE	DTID (3530) Hemodynamic Acquisition Context	1	M		\$LocationName = EV (G-C0E3, SRT, "Finding Site") \$LocationValue = DCID (3607) Venous source locations
3	>	CONTAINS	INCLUDE	DTID (300) Measurement	1	M		\$Measurement = EV (F 31150, SRT, "Mean blood pressure") \$Units = DCID (3500) Pressure Units
4	>	CONTAINS	INCLUDE	DTID (3550) Pressure waveform measurements	1-n	U		

**TID 3507 Ventricular Pressure Measurement**

The Ventricular Pressure Measurement template consists of a CONTAINER, with an acquisition context of the measurement anatomic site, and containing systolic and end-diastolic measurements. This implies that the name of the measurement is effectively post-coordinated from the measurement name, the Hemodynamic Measurement Group container (procedure phase) name, and the acquisition context (finding site) value.

**TID 3507  
Ventricular Pressure Measurement  
Type: Extensible**

	NL	Relation with Parent	Value Type	Concept Name	VM	Req Type	Condition	Value Set Constraint
1			CONTAINER	EV (122122, DCM, "Ventricular pressure measurements")	1	M		
2	>		INCLUDE	DTID (3530) Hemodynamic Acquisition Context	1	M		\$LocationName = EV (G-C0E3, SRT, "Finding Site") \$LocationValue = DCID (3609) Ventricular source locations
3	>	CONTAINS	INCLUDE	DTID (300) Measurement	1	MC	IFF \$LocationValue selected in row 2 is (T-32600, SRT, "Left Ventricle") or subsite thereof	\$Measurement = EV (F-03E0D, SRT, "Left Ventricular Systolic blood pressure") \$Units = DCID (3500) Pressure Units

	NL	Relation with Parent	Value Type	Concept Name	VM	Req Type	Condition	Value Set Constraint
4	>	CONTAINS	INCLUDE	DTID (300) Measurement	1	MC	IFF \$LocationValue selected in row 2 is (T-32600, SRT, "Left Ventricle") or subsite thereof	\$Measurement = EV (F-03E0E, SRT, "Left Ventricular End Diastolic pressure") \$Units = DCID (3500) Pressure Units
5	>	CONTAINS	INCLUDE	DTID (300) Measurement	1	MC	IFF \$LocationValue selected in row 2 is (T-32500, SRT, "Right Ventricle") or subsite thereof	\$Measurement = EV (F-03DFE, SRT, "Right Ventricular Systolic blood pressure") \$Units = DCID (3500) Pressure Units
6	>	CONTAINS	INCLUDE	DTID (300) Measurement	1	MC	IFF \$LocationValue selected in row 2 is (T-32500, SRT, "Right Ventricle") or subsite thereof	\$Measurement = EV (F-03E02, SRT, "Right Ventricular End Diastolic pressure") \$Units = DCID (3500) Pressure Units
7	>	CONTAINS	INCLUDE	DTID (300) Measurement	1	MC	IFF \$LocationValue selected in row 2 is (T-32400, SRT, "Common Ventricle")	\$Measurement = EV (122194, DCM, "Ventricular Systolic blood pressure") \$Units = DCID (3500) Pressure Units
8	>	CONTAINS	INCLUDE	DTID (300) Measurement	1	MC	IFF \$LocationValue selected in row 2 is (T-32400, SRT, "Common Ventricle")	\$Measurement = EV (122191, DCM, "Ventricular End Diastolic pressure") \$Units = DCID (3500) Pressure Units
9	>	CONTAINS	INCLUDE	DTID (3550) Pressure waveform measurements	1-n	U		

### TID 3508 Gradient Measurement

The Gradient Measurement template consists of a CONTAINER, with an acquisition context of the measurement anatomic site, and containing the gradient measurement. This implies that the name of the measurement is effectively post-coordinated from the measurement name, the Hemodynamic Measurement Group container (procedure phase) name, and the acquisition context (finding site) value.

#### TID 3508 Gradient Measurement Type: Extensible

	NL	Relation with Parent	Value Type	Concept Name	VM	Req Type	Condition	Value Set Constraint
1			CONTAINER	EV (122123, DCM, "Gradient assessment")	1	M		
2	>		INCLUDE	DTID (3530) Hemodynamic Acquisition Context	1	MC	XOR with Rows 3 & 4 IFF single location is appropriate	\$LocationName = EV (G-C0E3, SRT, "Finding Site") \$LocationValue = DCID (3610) Gradient Source Locations
3	>		INCLUDE	DTID (3530) Hemodynamic Acquisition Context	1	MC	XOR with Row 2 IFF a dual location is appropriate	\$LocationName = EV (121116, DCM, "Proximal Finding Site")

	NL	Relation with Parent	Value Type	Concept Name	VM	Req Type	Condition	Value Set Constraint
								\$LocationValue = DCID (3630) Cardiovascular Anatomic Locations
4	>		INCLUDE	DTID (3530) Hemodynamic Acquisition Context	1	MC	XOR with Row 2 IFF a dual location is appropriate	\$LocationName = EV (121117, DCM, "Distal Finding Site") \$LocationValue = DCID (3630) Cardiovascular Anatomic Locations
5	>	CONTAINS	INCLUDE	DTID (300) Measurement	1-n	M		\$Measurement = EV (F-023F7, "Pressure Gradient") \$Units = DCID (3500) Pressure Units \$Derivation = DCID (3627) Measurement Type
6	>	CONTAINS	INCLUDE	DTID (3550) Pressure waveform measurements	1-n	U		

### Content Item Descriptions

Row 5, which is used to encode the gradient measurements, uses Template 300 for the content item structure of the measurements. That template allows an INFERRED FROM relationship to other numeric measurements used in the computation or derivation of the current measurement. In the case of a gradient measurement, the pressure measurements at the distal and proximal locations may thus be explicitly conveyed.

### TID 3509 Blood Velocity Measurement

The Blood Velocity Measurement template consists of a CONTAINER, with an acquisition context of the measurement anatomic site, and containing primary (not derived) velocity measurements, e.g., from a Doppler catheter. Derived velocity measurements may be recorded using TID 3560.

#### TID 3509 Blood Velocity Measurement Type: Extensible

	NL	Relation with Parent	Value Type	Concept Name	VM	Req Type	Condition	Value Set Constraint
1			CONTAINER	EV (122124, DCM, "Blood velocity measurements")	1	M		
2	>		INCLUDE	DTID (3530) Hemodynamic Acquisition Context	1	M		\$LocationName = EV (G-C0E9, SRT, "Procedure site") \$LocationValue = BCID (3606) Arterial source locations
3	>	CONTAINS	INCLUDE	DTID (300) Measurement	1-n	M		\$Measurement = DCID (3612) Blood Velocity Measurements \$Units = EV (mm/s, UCUM, "mm/s")
4	>	CONTAINS	INCLUDE	DTID (3550) Pressure waveform measurements	1-n	U		

**TID 3510 Vital Signs**

The Vital Signs template consists of a CONTAINER containing the various vital signs measurements. These measurements may be acquired automatically from patient monitoring equipment, or may be entered based on manual measurements.

**TID 3510  
Vital Signs  
Type: Extensible**

	NL	Relation with Parent	Value Type	Concept Name	VM	Req Type	Condition	Value Set Constraint
1			CONTAINER	EV (8716-3, LN, "Vital Signs")	1	M		
2	>	CONTAINS	INCLUDE	TID (300) Measurement	1	U		\$Measurement = EV (F-008EC, SRT, "Systolic blood pressure") \$Units = DCID (3500) \$Method = BCID (3560) Blood Pressure Methods
3	>	CONTAINS	INCLUDE	TID (300) Measurement	1	U		\$Measurement = EV (F-008ED, SRT, "Diastolic blood pressure") \$Units = DCID (3500)
4	>	CONTAINS	INCLUDE	TID (300) Measurement	1	U		\$Measurement = EV (8867-4, LN, "Heart rate") \$Units = EV ("{H.B.}/min", UCUM, "BPM")
5	>	CONTAINS	INCLUDE	TID (300) Measurement	1	U		\$Measurement = EV (8310-5, LN, "Body temperature") \$Units = EV (Cel, UCUM, "°C")
6	>	CONTAINS	INCLUDE	TID (300) Measurement	1	U		\$Measurement = DCID (3526) Blood gas saturation \$Units = EV (% , UCUM, "%")
7	>	CONTAINS	INCLUDE	TID (300) Measurement	1	U		\$Measurement = EV ( F-043E7, SRT, "Respiration rate") \$Units = EV (/min, UCUM, "breaths/min")
8	>	CONTAINS	INCLUDE	TID (300) Measurement	1	U		\$Measurement = EV (122195, DCM, "Pulse Strength") \$Units = DT("{0:4}", UCUM, "range 0:4")
9	>	CONTAINS	INCLUDE	TID (300) Measurement	1	U		\$Measurement = EV (F-009EA, SRT, "Pain Score") \$Units = DT("{1:10}", UCUM, "range 1:10")
10	>	CONTAINS	CODE	DT (8884-9, LN, "Cardiac Rhythm")	1	U		BCID (3415) Cardiac Rhythms
11	>	CONTAINS	CODE	DT (9304-7, LN, "Respiration Rhythm")	1	U		BCID (3416) Respiration Rhythms

**TID 3515 Cardiac Output Measurement by Indicator Dilution**

The Cardiac Output Measurement by Indicator Dilution template consists of a CONTAINER containing the measurement and significant parameters of the technical method. If the measurement is based on a DICOM Hemodynamic Waveform SOP Instance, that object may also be referenced.

Note: Fick Cardiac Output is encoded in the Derived Hemodynamic Measurements Template 3560.

**TID 3515  
Cardiac Output Measurement by Indicator Dilution  
Type: Extensible**

	NL	Relation with Parent	Value Type	Concept Name	VM	Req Type	Condition	Value Set Constraint
1			CONTAINER	EV (P2-34201, SRT, "Cardiac Output measurement")	1	M		
2	>	CONTAINS	INCLUDE	TID (300) Measurement	1	M		\$Measurement = EV (8737-9, LN, "Cardiac Output by Indicator Dilution") \$Units = EV (l/min, UCUM, "l/min") \$Method = DCID (3628) Cardiac Output Methods \$WavePurpose = DT (121112, DCM, "Source of measurement")
3	>	HAS ACQ CONTEXT	NUM	EV (122319, DCM, "Catheter Size")	1	MC	IFF Row 2 indicates a thermal method	UNITS = DCID (3510) Catheter Size Units
4	>	HAS ACQ CONTEXT	NUM	EV (122320, DCM, "Injectate Temperature")	1	MC	IFF Row 2 indicates a thermal method	UNITS = EV (Cel, UCUM, "C")
5	>	HAS ACQ CONTEXT	NUM	EV (122321, DCM, "Injectate Volume")	1	M		UNITS = DT (ml, UCUM, "ml")
6	>	HAS ACQ CONTEXT	NUM	EV (122322, DCM, "Calibration Factor")	1	M		UNITS = DT (1, UCUM, "no units")

**TID 3516 Blood Lab Measurements**

The Blood Lab Measurements template provides for the recording of measurements made on blood samples obtained during a catheterization procedure. The type and anatomic source of the blood is recorded as acquisition context. The results from the blood chemistry measurement system are quoted; the measurement names may be pre-coordinated with the type or source of the blood, or generic measurement names may be reported. In the latter case, the full measurement concept name may be effectively post-coordinated using the recorded acquisition context.

**TID 3516  
Blood Lab Measurements  
Type: Extensible**

	NL	Relation with Parent	Value Type	Concept Name	VM	Req Type	Condition	Value Set Constraint
1			CONTAINER	EV (122125, DCM, "Blood lab measurements")	1	M		
2	>	HAS ACQ CONTEXT	CODE	EV (121042, DCM, "Specimen Type")	1	M		DCID (3520) Blood Source Type
3	>	HAS ACQ CONTEXT	CODE	EV (G-C0E9, SRT, "Procedure site")	1	M		BCID (3630) Cardiovascular Anatomic Locations

	NL	Relation with Parent	Value Type	Concept Name	VM	Req Type	Condition	Value Set Constraint
4	>		INCLUDE	DTID (1000) Quotation	1	U		
5	>	CONTAINS	INCLUDE	TID (300) Measurement	1	U		\$Measurement = EV (718-7, LN, "Hemoglobin") \$Units = DT (g/dl, UCUM, "g/dl")
6	>	CONTAINS	INCLUDE	TID (300) Measurement	1-n	U		\$Measurement = DCID (3524) Blood Gas Pressures \$Units = DCID (3500)
7	>	CONTAINS	INCLUDE	TID (300) Measurement	1-n	U		\$Measurement = DCID (3525) Blood Gas Content \$Units = DT (ml/dl, UCUM, "ml/dl")
8	>	CONTAINS	INCLUDE	TID (300) Measurement	1-n	U		\$Measurement = DCID (3528) Blood pH \$Units = EV ([pH], UCUM, "pH")
9	>	CONTAINS	INCLUDE	TID (300) Measurement	1-n	U		\$Measurement = DCID (3526) Blood Gas Saturation \$Units = EV (% , UCUM, "%")
10	>	CONTAINS	INCLUDE	TID (300) Measurement	1-n	U		\$Measurement = DCID (3527) Blood Base Excess \$Units = DT (meq/dl, UCUM, "meq/dl")
11	>	CONTAINS	INCLUDE	TID (300) Measurement	1	U		\$Measurement = EV (122183, DCM, "Blood temperature") \$Units = EV (Cel, UCUM, "°C")

**TID 3520 Hemodynamic Clinical Context**

The Clinical Context template allows the recording of information about the patient's clinical state that may affect interpretation of the hemodynamic measurements. This Template includes several coded conditions (e.g., complications, drugs, physiological challenges, etc.), each of which may have a Concept Modifier of "Relative Time". This Modifier indicates the temporal relationship of the hemodynamic measurements to the conditions recorded in this template. E.g., the Content Item structure:

```
[CONTAINER] "Post-intervention phase"
  HAS ACQ CONTEXT [CONTAINER] "Clinical Context"
    CONTAINS [CODE] "Complication" "Arrhythmia"
      HAS CONCEPT MOD [CODE] "Relative Time" "After"
        CONTAINS [CONTAINER] "Arterial Measurements"
...

```

conveys the semantics that this group of measurements for the post-intervention phase of a cath procedure was made after an occurrence of arrhythmia in the patient.

In the absence of a Relative Time modifier, the acquisition context is during the identified event or state.

**TID 3520  
Hemodynamic Clinical Context  
Type: Extensible**

	NL	Relation with Parent	Value Type	Concept Name	VM	Req Type	Condition	Value Set Constraint
1			CONTAINER	EV (122127, DCM, "Clinical Context")	1	M		

2	>	CONTAINS	CODE	EV (109054, DCM, "Patient State")	1-n	U		BCID (3602) Hemodynamic Patient State
3	>	CONTAINS	TEXT	EV (109054, DCM, "Patient State")	1	U		
4	>	CONTAINS	INCLUDE	DTID (3521) Relative Time	1-n	U		\$ConditionName = EV (DD-60002, SRT, "Complication of Procedure") \$ConditionValue = DCID (3413) Adverse Outcomes
5	>	CONTAINS	INCLUDE	DTID (3521) Relative Time	1-n	U		\$ConditionName = EV (122086, DCM, "Contrast administered") \$ConditionValue = BCID (12) Radiographic Contrast Agent
6	>	CONTAINS	INCLUDE	DTID (3521) Relative Time	1-n	U		\$ConditionName = EV (122083, DCM, "Drug administered") \$ConditionValue = BCID (10) Interventional Drug
7	>	CONTAINS	INCLUDE	DTID (3521) Relative Time	1-n	U		\$ConditionName = EV (109059, DCM, "Physiological challenges") \$ConditionValue = BCID (3271) Hemodynamic Physiological Challenges
8	>	CONTAINS	INCLUDE	DTID (3521) Relative Time	1-n	U		\$ConditionName = EV (122138, DCM, "Circulatory Support") \$ConditionValue = DCID (3553) Circulatory Support
9	>	CONTAINS	INCLUDE	DTID (3521) Relative Time	1-n	U		\$ConditionName = EV (P2-2200A, SRT, "Ventilatory assistance") \$ConditionValue = DCID (3554) Ventilation
10	>	CONTAINS	INCLUDE	DTID (3521) Relative Time	1-n	U		\$ConditionName = EV (P2-35000, SRT, "Cardiac Pacing") \$ConditionValue = BCID (3555) Pacing
11	>	CONTAINS	INCLUDE	DTID (3521) Relative Time	1-n	U		\$ConditionName = EV (P0-0000, SRT, "Procedure") \$ConditionValue = BCID (3405) Procedure Action Values

**TID 3521 Relative Time**

The Relative Time template is invoked by 3520 Hemodynamic Acquisition Context template. It specifies an applicable clinical context condition and the time of the current measurements relative to that condition.

**TID 3521 Parameters**

Parameter Name	Parameter Usage
\$ConditionName	Coded term for Concept Name of condition
\$ConditionValue	Context Group for condition values

**TID 3521**  
**Relative Time**  
**Type: Non-Extensible**

	NL	Relation with Parent	Value Type	Concept Name	VM	Req Type	Condition	Value Set Constraint
1			CODE	\$ConditionName	1	M		\$ConditionValue
2	>	HAS CONCEPT MOD	CODE	EV (G-D709, SRT, "Relative time")	1	U		BCID (3600) Relative times

**TID 3530 Hemodynamic Acquisition Context**

The Hemodynamic Acquisition Context template is invoked by the various hemodynamic measurement templates.

Parameter Name	Parameter Usage
\$LocationName	Coded term for Concept Name of measurement location
\$LocationValue	Context Group for appropriate anatomic locations

**TID 3530**  
**Hemodynamic Acquisition Context**  
**Type: Extensible**

	NL	Relation with Parent	Value Type	Concept Name	VM	Req Type	Condition	Value Set Constraint
1		HAS CONCEPT MOD	CODE	\$LocationName	1	M		\$LocationValue
2	>	HAS CONCEPT MOD	CODE	EV (G-A1F8, SRT, "Topographical modifier")	1	U		BCID (3019) Cardiovascular anatomic location modifiers
3		HAS ACQ CONTEXT	CODE	EV (G-C036, SRT, "Measurement Method ")	1	U		BCID (3241) Hemodynamic Measurement Technique
4		HAS ACQ CONTEXT	WAVEFORM	DT (121112, DCM, "Source of measurement")	1	UC	XOR Row 5	
5		HAS ACQ CONTEXT	TCOORD	DT (121112, DCM, "Source of measurement")	1	UC	XOR Row 4	
6	>	SELECTED FROM	WAVEFORM		1	M		

**TID 3550 Pressure Waveform Measurements**

The Pressure Waveform Measurements template is invoked by the various hemodynamic measurement templates for recording general measurements made in conjunction with the specific required measurements for that anatomic location.



**TID 3550**  
**Pressure Waveform Measurements**  
**Type: Extensible**

	NL	Relation with Parent	Value Type	Concept Name	VM	Req Type	Condition	Value Set Constraint
1		CONTAINS	INCLUDE	TID (300) Measurement	1-n	U		\$Measurement = DCID (3611) Pressure Measurements \$Units = DCID (3500)
2		CONTAINS	INCLUDE	TID (300) Measurement	1-n	U		\$Measurement = DCID (3612) Blood Velocity Measurements \$Units = EV (mm/s, UCUM, "mm/s")
3		CONTAINS	INCLUDE	TID (300) Measurement	1-n	U		\$Measurement = DCID (3613) Hemodynamic Time Measurements \$Units = DT (ms, UCUM, "ms")
4		CONTAINS	INCLUDE	TID (300) Measurement	1	U		\$Measurement = EV (F-32100, SRT, "Cardiac Output") \$Units = EV (l/min, UCUM, "l/min")
5		CONTAINS	INCLUDE	TID (300) Measurement	1	U		\$Measurement = EV (20562-5, LN, "Stroke Volume") \$Units = DT (ml, UCUM, "ml")
6		CONTAINS	INCLUDE	TID (300) Measurement	1	U		\$Measurement = EV (10230-1, LN, "LV Ejection Fraction") \$Units = EV (% , UCUM, "%")
7		CONTAINS	INCLUDE	TID (300) Measurement	1	U		\$Measurement = EV (8867-4, LN, "Heart rate") \$Units = DT ("{H.B.}/min", UCUM, "BPM")
8		CONTAINS	INCLUDE	TID (300) Measurement	1	U		\$Measurement = EV ( F-043E7, SRT, "Respiration rate") \$Units = DT ("/min", UCUM, "breaths/min")
9		CONTAINS	INCLUDE	TID (300) Measurement	1	U		\$Measurement = EV (109025, DCM, "Max dp/dt") \$Units = DT (mm[Hg]/s, UCUM, "mmHg/s")
10		CONTAINS	INCLUDE	TID (300) Measurement	1	U		\$Measurement = EV (109026, DCM, "Max neg dp/dt") \$Units = DT (mm[Hg]/s, UCUM, "mmHg/s")
11		CONTAINS	INCLUDE	TID (300) Measurement	1	U		\$Measurement = EV (122190, DCM, "Max dp/dt/P") \$Units = DT (s-1, UCUM, "/s")
12		CONTAINS	INCLUDE	TID (300) Measurement	1	U		\$Measurement = EV (122192, DCM, "Indicator appearance time") \$Units = DT (s, UCUM, "s")
13		CONTAINS	INCLUDE	TID (300) Measurement	1	U		\$Measurement = EV (122193, DCM, "Maximum pressure acceleration") \$Units = DT (mm[Hg]/s2, UCUM, "mmHg/s/s")
14		CONTAINS	INCLUDE	TID (300) Measurement	1-n	U		\$Measurement = DCID (3617) Valve Flows \$Units = DT (ml/min, UCUM, "ml/min")

**TID 3560 Derived Hemodynamic Measurements**

The Derived Hemodynamic Measurements template consists of a CONTAINER containing measurements derived from one or more other measurements. These measurements are associated with a particular procedure phase, but not necessarily with a particular anatomic location.

**TID 3560  
Derived Hemodynamic Measurements  
Type: Extensible**

	NL	Relation with Parent	Value Type	Concept Name	VM	Req Type	Condition	Value Set Constraint
1			CONTAINER	EV (122126, DCM, "Derived Hemodynamic Measurements")	1	U		
2	>	CONTAINS	INCLUDE	TID (300) Measurement	1-n	U		\$Measurement = DCID (3614) Valve Areas, non-Mitral \$Units = EV (cm2, UCUM, "cm2") \$Equation = DT (122262, DCM, "Area = Flow / 44.5 * sqrt(Gradient[mmHg])")
3	>	CONTAINS	INCLUDE	TID (300) Measurement	1	U		\$Measurement = EV (F-02320, SRT, "Mitral Valve Area") \$Units = EV (cm2, UCUM, "cm2") \$Equation = DT (122263, DCM, "MVA= Flow / 38.0 * sqrt(Gradient[mmHg])")
4	>	CONTAINS	INCLUDE	TID (300) Measurement	1-n	U		\$Measurement = DCID (3615) Valve Areas \$ModType = EV (121425, DCM, "Index") \$ModValue = EV (8277-6, LN, "Body Surface Area") \$Units = DT (cm2/m2, UCUM, "cm2/m2")
5	>	CONTAINS	INCLUDE	TID (300) Measurement	1-n	U		\$Measurement = DCID (3616) Hemodynamic Period Measurements \$Units = DT ("s/min", UCUM, "s/min")
6	>	CONTAINS	INCLUDE	TID (300) Measurement	1-n	U		\$Measurement = DCID (3617) Valve Flows \$Units = DT (ml/s, UCUM, "ml/s")
7	>	CONTAINS	INCLUDE	TID (300) Measurement	1	U		\$Measurement = EV (F-32110, SRT, "Cardiac Index") \$Units = DT (l/min/m2, UCUM, "l/min/m2")
8	>	CONTAINS	INCLUDE	TID (300) Measurement	1-n	U		\$Measurement = DCID (3529) Arterial / Venous Content \$Units = DT (ml/dl, UCUM, "ml/dl")
9	>	CONTAINS	INCLUDE	TID (300) Measurement	1-n	U		\$Measurement = DCID (3618) Hemodynamic Flows \$Units = DT (l/min, UCUM, "l/min")
10	>	CONTAINS	INCLUDE	TID (300) Measurement	1	U		\$Measurement = EV (8736-1, LN, "FICK Cardiac Output") \$Units = DT (l/min, UCUM, "l/min")
11	>	CONTAINS	INCLUDE	TID (300) Measurement	1	U		\$Measurement = EV (8750-2, LN, "FICK Cardiac Index")

	NL	Relation with Parent	Value Type	Concept Name	VM	Req Type	Condition	Value Set Constraint
								\$Units = DT (l/min/m2, UCUM, "l/min/m2")
12	>	CONTAINS	INCLUDE	TID (300) Measurement	1	U		\$Measurement = EV (122229, DCM, "Arteriovenous difference") \$Units = DT (ml/dl, UCUM, "ml/dl")
13	>	CONTAINS	INCLUDE	TID (300) Measurement	1-n	U		\$Measurement = BCID (3620) Hemodynamic Ratios \$Units = DT (1, UCUM, "ratio")
14	>	CONTAINS	INCLUDE	TID (300) Measurement	1	U		\$Measurement = EV (122237, DCM, "Corrected Sinus Node Recovery Time") \$Units = DT (ms, UCUM, "ms")
15	>	CONTAINS	INCLUDE	TID (300) Measurement	1	U		\$Measurement = EV (8861-7, LN, "Left Ventricular Stroke Work") \$Units = DT (g.m, UCUM, "g.m")
16	>	CONTAINS	INCLUDE	TID (300) Measurement	1	U		\$Measurement = EV (8862-5, LN, "Right Ventricular Stroke Work") \$Units = DT (g.m, UCUM, "g.m")
17	>	CONTAINS	INCLUDE	TID (300) Measurement	1	U		\$Measurement = EV (8863-3, LN, "Left Ventricular Stroke Work Index") \$Units = DT (g.m/m2, UCUM, "g.m/m2")
18	>	CONTAINS	INCLUDE	TID (300) Measurement	1	U		\$Measurement = EV (8864-1, LN, "Right Ventricular Stroke Work Index") \$Units = DT (g.m/m2, UCUM, "g.m/m2")
19	>	CONTAINS	INCLUDE	TID (300) Measurement	1	U		\$Measurement = EV (122238, DCM, "Max volume normalized to 50mmHg pulse pressure") \$Units = DT (ml, UCUM, "ml")
20	>	CONTAINS	INCLUDE	TID (300) Measurement	1	U		\$Measurement = EV (122239, DCM, "Oxygen Consumption") \$Units = DT (ml/min, UCUM, "ml/min") \$Equation = BCID (3664) Oxygen Consumption Equations and Tables
21	>	CONTAINS	INCLUDE	TID (300) Measurement	1	U		\$Measurement = EV (19217-9, LN, "Oxygen partial pressure at 50% saturation (P50)") \$Units = DCID (3500) \$Equation = BCID (3666) P50 Equations
22	>	CONTAINS	INCLUDE	TID (300) Measurement	1	U		\$Measurement = EV (11556-8, LN, "Blood Oxygen partial pressure") \$Units = DCID (3500)
23	>	CONTAINS	INCLUDE	TID (300) Measurement	1-n	U		\$Measurement = DCID (3618) Hemodynamic Flows \$ModType = EV (121425, DCM, "Index") \$ModValue = EV (8277-6, LN, "Body Surface Area") \$Units = DT (l/min/m2, UCUM, "l/min/m2")
24	>	CONTAINS	INCLUDE	TID (300) Measurement	1-n	U		\$Measurement = DCID (3619) Hemodynamic Resistance

	NL	Relation with Parent	Value Type	Concept Name	VM	Req Type	Condition	Value Set Constraint
				Measurement				Measurements \$Units = BCID (3502) Hemodynamic Resistance Units
25	>	CONTAINS	INCLUDE	TID (300) Measurement	1-n	U		\$Measurement = DCID (3619) Hemodynamic Resistance Measurements \$ModType = EV (121425, DCM, "Index") \$ModValue = EV (8277-6, LN, "Body Surface Area") \$Units = BCID (3503) Indexed Hemodynamic Resistance Units
26	>	CONTAINS	INCLUDE	TID (300) Measurement	1	U		\$Measurement = EV (122227, DCM, "Left to Right Flow") \$Units = DT (l/min, UCUM, "l/min")
27	>	CONTAINS	INCLUDE	TID (300) Measurement	1	U		\$Measurement = EV (122228, DCM, "Right to Left Flow") \$Units = DT (l/min, UCUM, "l/min")
28	>	CONTAINS	INCLUDE	TID (300) Measurement	1	U		\$Measurement = EV (20562-5, LN, "Stroke Volume") \$Units = DT (ml, UCUM, "ml")
29	>	CONTAINS	INCLUDE	TID (300) Measurement	1	U		\$Measurement = EV (20562-5, LN, "Stroke Volume") \$ModType = EV (121425, DCM, "Index") \$ModValue = EV (8277-6, LN, "Body Surface Area") \$Units = DT (ml/m2 UCUM, "ml/m2")
30	>	CONTAINS	INCLUDE	TID (300) Measurement	1	U		\$Measurement = EV (F-042BA, SRT, "Total blood volume") \$Units = DT (l, UCUM, "l")
31	>	CONTAINS	INCLUDE	TID (300) Measurement	1-n	U		\$Measurement = DCID (3667) Framingham Scores \$Units = DT (% , UCUM, "%") \$Equation = DCID (3668) Framingham Tables

**TID 3570 Summary, Hemodynamics**

This Template allows the recording of any significant numeric measurements or findings.

**TID 3570  
Summary, Hemodynamics  
Type: Extensible**

	NL	Relation with Parent	Value Type	Concept Name	VM	Req Type	Condition	Value Set Constraint
1		CONTAINS	CONTAINER	EV (121111, DCM, "Summary")	1	M		
2	>	CONTAINS	TEXT	EV (121111, DCM, "Summary")	1	U		
3	>	CONTAINS	INCLUDE	DTID (300) Measurement	1-n	U		
4	>	CONTAINS	CODE	EV (121071, DCM, "Finding")	1-n	U		DCID (3640) Hypertension

	NL	Relation with Parent	Value Type	Concept Name	VM	Req Type	Condition	Value Set Constraint
5	>>		INCLUDE	DTID (1350) "Negation Modifier, Presence of Finding"	1	U		
6	>>	HAS PROPERTIES	CODE	EV (G-C197, SRT, "Severity")	1	U		DCID (3716) Severity
7	>	CONTAINS	CODE	DCID (3641) Hemodynamic Assessments	1-n	U		DCID (3642) Degree Findings
8	>>	HAS PROPERTIES	CODE	EV (G-C0B2, SRT, "Condition")	1	U		EV (R-102B9, SRT, "Large v-wave")
9	>	CONTAINS	CODE	EV (121071, DCM, "Finding")	1	U		EV (R-102BA, SRT, "Diastolic pressure equalization")

### TID 3601 Procedure Context

The Procedure Context template describes acquisition context for measurements made or events recorded in a procedure.

#### TID 3601 Procedure Context Type: Extensible

	NL	Relation with Parent	Value Type	Concept Name	VM	Req Type	Condition	Value Set Constraint
1		HAS ACQ CONTEXT	TEXT	EV (121065, DCM, "Procedure Description")	1	U		Defaults to Study Description (0008,1030) of the General Study Module
2		HAS ACQ CONTEXT	CODE	EV (G-C0E8, SRT, "Has Intent")	1	U		BCID (3629) Procedure Intent
3		HAS ACQ CONTEXT	CODE	EV (G-C09C, SRT, "Procedure Priority")	1	U		BCID (3414) Procedure Urgency
4		HAS OBS CONTEXT	CODE	EV (121023, DCM, "Procedure Code")	1-n	U		Defaults to Procedure Code Sequence (0008,1032) of General Study Module

### TID 3602 Cardiovascular Patient Characteristics

Patient Characteristic concepts in this template, which may replicate attributes in the Patient Study Module, are included here as possible targets of by-reference relationships from other content items in the SR tree.

Note: Several of the concepts in this template duplicate concepts in TID 1007 "Subject Context, Patient". The difference in use is that this template has those concepts as primary observations of the patient, while in TID 1007 the concepts are used to set (or reset) the context for other observations.

#### TID 3602 Cardiovascular Patient Characteristics Type: Extensible

	NL	Relation with Parent	Value Type	Concept Name	VM	Req Type	Condition	Value Set Constraint
1			CONTAINER	EV (121118, DCM, "Patient Characteristics")	1	M		
2	>	CONTAINS	NUM	EV (121033, DCM,	1	M		Units = DCID (7456)

	NL	Relation with Parent	Value Type	Concept Name	VM	Req Type	Condition	Value Set Constraint
				"Subject Age")				Units of Measure for Age
3	>	CONTAINS	CODE	EV (121032, DCM, "Subject Sex")	1	M		DCID (7455) Sex
4	>	CONTAINS	NUM	EV (8302-2, LN, "Patient Height")	1	M		UNITS = EV (cm, UCUM, "cm")
5	>	CONTAINS	NUM	EV (29463-7, LN, "Patient Weight")	1	M		UNITS = EV (kg, UCUM, "kg")
6	>	CONTAINS	NUM	EV (122221, DCM, "Thorax diameter, sagittal")	1	U		UNITS = EV (cm, UCUM, "cm")
7	>	CONTAINS	NUM	EV (8277-6, LN, "Body Surface Area")	1	M		UNITS = EV (m2, UCUM, "m^2")
8	>>	INFERRED FROM	CODE	EV (8278-4, LN, "Body Surface Area Formula")	1	U		BCID (3663) Body Surface Area Equations
9	>	CONTAINS	NUM	EV (F-01860, SRT, "Body Mass Index")	1	U		UNITS = EV (kg/m2, UCUM, "kg/m^2")
10	>>	INFERRED FROM	CODE	EV (121420, DCM, "Equation")	1	U		DT (122265, DCM, "BMI = Wt/Ht^2")
11	>	CONTAINS	NUM	EV (8867-4, LN, "Heart Rate")	1	U		UNITS = EV ("{H.B.}/min", UCUM, "BPM")
12	>	CONTAINS	NUM	EV (F-008EC, SRT, "Systolic Blood Pressure")	1	U		Units = DCID (3500)
13	>	CONTAINS	NUM	EV (F-008ED, SRT, "Diastolic Blood Pressure")	1	U		Units = DCID (3500)

**TID 3603 Procedure Environmental Characteristics**

**TID 3603  
Procedure Environmental Characteristics  
Type: Extensible**

	NL	Relation with Parent	Value Type	Concept Name	VM	Req Type	Condition	Value Set Constraint
1			CONTAINER	EV (122222, DCM, "Procedure Environmental Characteristics")	1	M		
2	>	CONTAINS	NUM	EV (122223, DCM, "Room oxygen concentration")	1	U		UNITS = EV (% , UCUM, "%")
3	>	CONTAINS	NUM	EV (122224, DCM, "Room temperature")	1	U		UNITS = EV (Cel, UCUM, "°C")
4	>	CONTAINS	NUM	EV (122225, DCM, "Room Barometric pressure")	1	U		UNITS = DT (mbar, UCUM, "millibar")

**ECG REPORT TEMPLATES**

**TID 3700 ECG Report**

The ECG Report template is the root structure for the representation of analysis of an ECG waveform, potentially in comparison to a prior ECG waveform analysis. The analyzed waveform may or may not be stored as a DICOM SOP Instance.

**TID 3700  
ECG Report  
Type: Extensible**

	NL	Relation with Parent	Value Type	Concept Name	VM	Req Type	Condition	Value Set Constraint
1			CONTAINER	EV (28010-7, LN, "ECG Report")	1	M		
2	>	HAS CONCEPT MOD	CODE	EV (121058, DCM, "Procedure reported")	1	U		DCID (3670) ECG Procedure Types
3	>	HAS CONCEPT MOD	INCLUDE	DTID (1204) Language of Content Item and Descendants	1	M		
4	>	CONTAINS	INCLUDE	DTID (1002) Observer Context	1-n	M		
5	>	CONTAINS	INCLUDE	DTID (3701) "Clinical Context, ECG"	1	U		
6	>	CONTAINS	INCLUDE	DTID (3702) Prior ECG Exam	1	U		
7	>	CONTAINS	INCLUDE	DTID (3708) ECG Waveform Information	1	M		
8	>	CONTAINS	CONTAINER	EV (122144, DCM, "Quantitative Analysis")	1	M		
9	>>	CONTAINS	INCLUDE	DTID (3713) Global Measurements	1-n	U		
10	>>	CONTAINS	INCLUDE	DTID (3714) ECG Lead Measurements	1-n	U		
11	>	CONTAINS	INCLUDE	DTID (3717) ECG Qualitative Analysis	1	U		
12	>	CONTAINS	INCLUDE	DTID (3719) "Summary, ECG"	1	U		

**TID 3701 Clinical Context, ECG**

**TID 3701  
Clinical Context, ECG  
Type: Extensible**

	NL	Relation with Parent	Value Type	Concept Name	VM	Req Type	Condition	Value Set Constraint
1		CONTAINS	CONTAINER	EV (122127, DCM, "Clinical Context")	1	U		
2	>	CONTAINS	CODE	EV (122139, DCM, "Reason for Exam")	1-n	U		DCID (3671) Reason for ECG Exam
3	>	CONTAINS	TEXT	EV (122139, DCM, "Reason for Exam")	1	U		
4	>	CONTAINS	CODE	EV (109054, DCM, "Patient	1	U		DCID (3262) ECG

	NL	Relation with Parent	Value Type	Concept Name	VM	Req Type	Condition	Value Set Constraint
				State")				Patient State Values
5	>	CONTAINS	CODE	EV (G-02D0, SRT, "Regular Medication")	1-n	U		No BCID
6	>	CONTAINS	TEXT	EV (G-02D0, SRT, "Regular Medication")	1	U		
7	>	CONTAINS	CODE	EV (G-02EC, SRT, "Pacemaker in situ")	1-n	U		DCID (3672) Pacemakers
8	>	CONTAINS	TEXT	EV (G-02EC, SRT, "Pacemaker in situ")	1	U		
9	>	CONTAINS	CODE	EV (121060, DCM, "History")	1-n	U		DCID (3673) Diagnosis
10	>	CONTAINS	TEXT	EV (121060, DCM, "History")	1	U		

**TID 3702 Prior ECG Exam**

**TID 3702  
Prior ECG Exam  
Type: Extensible**

	NL	Relation with Parent	Value Type	Concept Name	VM	Req Type	Condition	Value Set Constraint
1		CONTAINS	CONTAINER	EV (121066, DCM, "Prior Procedure Descriptions ")	1	M		
2	>	CONTAINS	CODE	EV (122140, DCM, "Comparison with Prior Exam Done")	1	M		DCID (230) Yes-No
3	>	CONTAINS	DATETIME	EV (122146, DCM, "Procedure DateTime")	1	U		
4	>	CONTAINS	COMPOSITE	EV (122075, DCM, "Prior report for current patient")	1	U		
5	>	CONTAINS	WAVEFORM	EV (121112, DCM, "Source of Measurement")	1	U		

**TID 3708 ECG Waveform Information**

The ECG Waveform Information template provides reference to, and important parameters of, the analyzed waveform.

**TID 3708  
ECG Waveform Information  
Type: Extensible**

	NL	Relation with Parent	Value Type	Concept Name	VM	Req Type	Condition	Value Set Constraint
1			CONTAINER	EV (121064, DCM, "Current Procedure Descriptions")	1	M		
2	>	CONTAINS	WAVEFORM	EV (121112, DCM, "Source of Measurement")	1	U		
3	>	HAS ACQ CONTEXT	CODE	EV (5.4.5-33-1, SCPECG [1.3], "Electrode Placement")	1	U		DCID (3263) Electrode Placement Values
4	>	HAS ACQ	CODE	EV (5.4.5-33-2, SCPECG	1	U		DCID (3264) XYZ



	NL	Relation with Parent	Value Type	Concept Name	VM	Req Type	Condition	Value Set Constraint
		CONTEXT		[1.3], "XYZ Electrode Configuration")				Electrode Placement Values
5	>	HAS ACQ CONTEXT	TEXT	EV (122142, DCM, "Acquisition Device Type")	1	U		
6	>	HAS ACQ CONTEXT	TEXT	EV (121122, DCM, "Equipment Identifier")	1	U		
7	>	HAS ACQ CONTEXT	INCLUDE	DTID (1003) Person Observer Identifying Attributes	1	U		
8	>	HAS ACQ CONTEXT	TEXT	EV (121121, DCM, "Room Identification")	1	U		
9	>	HAS ACQ CONTEXT	DATETIME	EV (122146, DCM, "Procedure DateTime")	1	M		
10	>	HAS ACQ CONTEXT	NUM	EV (5.4.5-27, SCPECG [1.3], "Baseline Filter Frequency")	1	U		UNITS = EV (Hz, UCUM, "Hz")
11	>	HAS ACQ CONTEXT	NUM	EV (5.4.5-28, SCPECG [1.3], "Low-Pass Filter Frequency")	1	U		UNITS = EV (Hz, UCUM, "Hz")
12	>	HAS ACQ CONTEXT	CODE	EV (5.4.5-29, SCPECG [1.3], "Filters")	1-n	U		DCID (3675) Other Filters

### TID 3713 ECG Global Measurements

The ECG Global Measurements Template provides a structure for measurements calculated across the ECG waveform as a whole (multiple leads).

#### TID 3713 ECG Global Measurements Type: Extensible

	NL	Relation with Parent	Value Type	Concept Name	VM	Req Type	Condition	Value Set Constraint
1			CONTAINER	EV (122158, DCM, "ECG Global Measurements")	1	M		
2	>	HAS OBS CONTEXT	INCLUDE	DTID (3715) ECG Measurement Source	1	U		
3	>	CONTAINS	NUM	EV (5.10.2.5-3, SCPECG[1.3], "Atrial Heart Rate")	1	U		UNITS = EV ({H.B.}/min, UCUM, "heart beats per minute")
4	>	CONTAINS	NUM	EV (5.10.2.5-1, SCPECG[1.3], "Ventricular Heart Rate")	1	M		UNITS = EV ({H.B.}/min, UCUM, "heart beats per minute")
5	>	CONTAINS	NUM	EV ( F-38292, SRT, "QT Duration")	1	M		UNITS = EV (ms, UCUM, "ms")
6	>	CONTAINS	NUM	EV (5.10.2.5-5, SCPECG[1.3], "QT Corrected Duration")	1	U		UNITS = EV (ms, UCUM, "ms")
7	>	CONTAINS	CODE	EV (5.10.2.5-7, SCPECG[1.3], "Correction Algorithm")	1	U		DCID (3678) QT Correction Algorithms
8	>	CONTAINS	NUM	EV ( F-025C5, SRT, "PR Duration")	1	M		UNITS = EV (ms, UCUM, "ms")
9	>	CONTAINS	NUM	EV ( F-025C6, SRT, "QRS	1	M		UNITS = EV (ms,

	NL	Relation with Parent	Value Type	Concept Name	VM	Req Type	Condition	Value Set Constraint
				Duration")				UCUM, "ms")
10	>	CONTAINS	NUM	EV (5.10.3-11, SCPECG [1.3], "P Axis")	1	U		UNITS = EV (deg, UCUM, "°")
11	>	CONTAINS	NUM	EV (5.10.3-13, SCPECG [1.3], "QRS Axis")	1	U		UNITS = EV (deg, UCUM, "°")
12	>	CONTAINS	NUM	EV (5.10.3-15, SCPECG [1.3], "T Axis")	1	U		UNITS = EV (deg, UCUM, "°")

**TID 3714 ECG Lead Measurements**

The ECG Lead Measurements Template provides a structure for measurements calculated on individual ECG leads.

**TID 3714  
ECG Lead Measurements  
Type: Extensible**

	NL	Relation with Parent	Value Type	Concept Name	VM	Req Type	Condition	Value Set Constraint
1			CONTAINER	EV (122159, DCM, "ECG Lead Measurements")	1	M		
2	>	HAS CONCEPT MOD	CODE	EV (122148, DCM, "Lead ID")	1	M		BCID (3001) ECG Leads
3	>	HAS OBS CONTEXT	INCLUDE	DTID (3715) ECG Measurement Source	1	U		
4	>	CONTAINS	NUM	DCID (3687) Electrophysiology Waveform Durations	1-n	U		UNITS = EV (ms, UCUM, "ms")
5	>	CONTAINS	NUM	DCID (3688) Electrophysiology Waveform Voltages	1-n	U		UNITS = EV (mv, UCUM, "mv")
6	>	CONTAINS	CODE	EV (5.13.5-47, SCPECG [1.3], "T Morphology Description")	1	U		DCID (3679) ECG Morphology Descriptions
7	>	CONTAINS	CODE	EV (5.13.5-45, SCPECG [1.3], "P Morphology Description")	1	U		DCID (3679) ECG Morphology Descriptions
8	>	CONTAINS	NUM	EV (5.13.5-43, SCPECG [1.3], "ST Slope")	1	U		UNITS = EV (uV/s, UCUM, "uV/s ")
9	>	CONTAINS	CODE	DCID (3680) ECG Lead Noise Descriptions	1-n	U		DCID (3681) ECG Lead Noise Modifiers

**TID 3715 ECG Measurement Source**

The ECG Measurement Source Template provides a structure for identifying the particular cardiac cycle, or beat, in an analyzed ECG waveform used for the measurement group for which this template provides Observation Context. The cardiac cycle is identified by beat number, and optionally by specific temporal coordinates within a DICOM ECG waveform SOP Instance.

**TID 3715  
ECG Measurement Source  
Type: Extensible**

	NL	Relation with Parent	Value Type	Concept Name	VM	Req Type	Condition	Value Set Constraint
1			TEXT	EV (122149, DCM, "Beat Number")	1	U		Up to three numeric characters
2			CODE	EV (G-C036, SRT, "Measurement Method")	1	U		DCID (3676) Lead Measurement Technique
3			TCOORD	EV (121112, DCM, "Source of measurement")	1	U		
4	>	SELECTED FROM	WAVEFORM		1	U		

**Content Item Descriptions**

Row 1 Beat Number is specified as a numeric text string, and shall be treated as the ordinal of the beat (cardiac cycle) within the waveform acquisition for this lead that was analyzed for the measurements in this container (i.e., "1" for the first beat, "2" for the second, etc.). If absent, the measurements may have been made by a technique across multiple cycles as specified in Row 2 Measurement Method.

Rows 3 and 4 Source of measurement identify the specific channel and time period within a DICOM ECG Waveform SOP Instance that was analyzed for the measurements in this container.

**TID 3717 ECG Qualitative Analysis**

The ECG Qualitative Analysis template allows a free text qualitative interpretation of the analyzed ECG, as well as a structure for a coded analysis.

**TID 3717  
Qualitative Analysis, ECG  
Type: Extensible**

	NL	Relation with Parent	Value Type	Concept Name	VM	Req Type	Condition	Value Set Constraint
1		CONTAINS	CONTAINER	EV (122145, DCM, "Qualitative Analysis")	1	M		
2	>	CONTAINS	TEXT	EV (122147, DCM, "Clinical Interpretation")	1	M		
3	>	CONTAINS	CONTAINER	EV (122150, DCM, "Compound Statement")	1-n	U		
4	>>	CONTAINS	INCLUDE	DTID (3718) ECG Interpretive Statement	1-n	U		

**Content Item Descriptions**

Row 3 Interpretive Statement is a container for one or more coded statements, defined in Template 3718. This container will typically have the Continuity of Content (0040,A050) flag set to CONTINUOUS, as

multiple interpretive statements in one container may be linked by conjunctive terms, and should be understood as a continuous semantic unit.

**TID 3718 ECG Interpretive Statement**

The ECG Interpretive Statement template provides a structure for an atomic coded interpretation of an ECG, optionally followed by a conjunctive term to another interpretation coded in a subsequent invocation of this template.

**TID 3718  
ECG Interpretive Statement  
Type: Extensible**

	NL	Relation with Parent	Value Type	Concept Name	VM	Req Type	Condition	Value Set Constraint
1			CODE	EV (122151, DCM, "Trend")	1	U		DCID (3684) Trend
2	>	HAS CONCEPT MOD	CODE	EV (122157, DCM, "Probability")	1	U		DCID (3682) Probability
3			CODE	EV (122152, DCM, "Statement")	1	M		DCID (3686) ECG Interpretive Statements
4	>	HAS CONCEPT MOD	CODE	EV (122153, DCM, "Statement Modifier")	1	U		DCID (3683) Modifiers
5			CODE	EV (122154, DCM, "Conjunctive Term")	1	U		DCID (3685) Conjunctive Terms

**TID 3719 Summary, ECG**

**TID 3719  
Summary, ECG  
Type: Extensible**

	NL	Relation with Parent	Value Type	Concept Name	VM	Req Type	Condition	Value Set Constraint
1		CONTAINS	CONTAINER	EV (121111, DCM, "Summary")	1	M		
2	>	CONTAINS	TEXT	EV (121111, DCM, "Summary")	1	U		
3	>	CONTAINS	CODE	EV (121071, DCM, "Finding")	1	U		DCID (3677) Summary Codes ECG

## CATH LAB CLINICAL REPORT TEMPLATES

The templates that comprise the Cardiac Catheterization Report are interconnected as shown in Figure A-7.

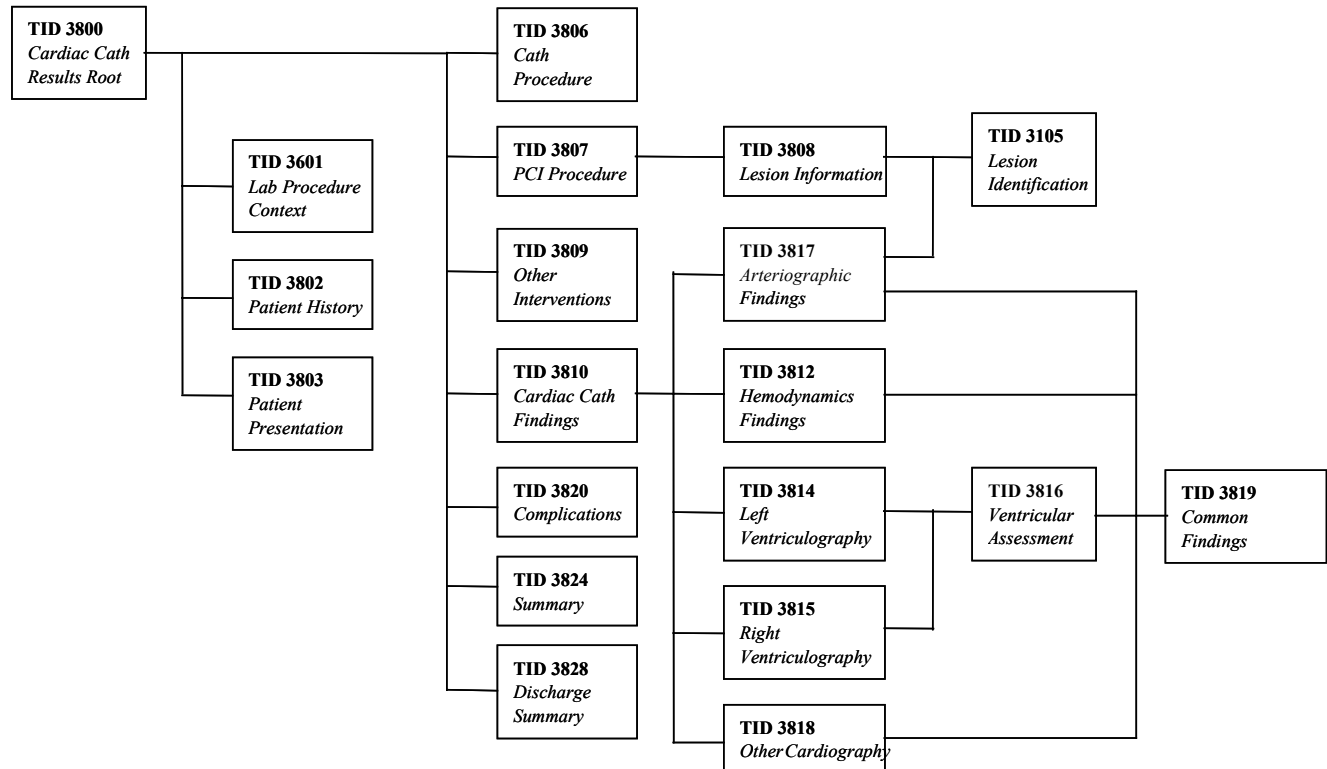

**Figure A-7 Cardiac Catheterization Report Template Hierarchy**

Note: The figure shows the relationship of templates; it does not show the structural hierarchy of Content Items in the IOD.

### TID 3800 Cardiac Catheterization Report Root

The Cardiac Cath Report provides the overall clinical results of the catheterization procedure and interventions. In many cases, more detailed information is optionally available in other reports (Hemodynamic Measurements, Procedure Log, etc.). That information is collected and summarized here (and referenced when available).

When a Discharge Summary section (row 12) is included, this report template covers the full set of information required for submission to the ACC NCDR™ (version 2.0) registry.

- Notes:
1. The information required for such a submission must sometimes be reformatted from a single concept in these templates to two data elements for the registry, or vice versa.
  2. This Template is expected to be used with the Basic Text SR or Enhanced SR IOD.
  3. This Cardiac Cath Report template is a baseline template within these SOP Classes that may be

replaced; it is therefore in no sense binding for exchange of this type of report. It is solely an example of a possible encoding of the Cardiac Cath Report.

**TID 3800**  
**Cardiac Catheterization Report Root**  
**Type: Extensible**

	NL	Relation with Parent	Value Type	Concept Name	VM	Req Type	Condition	Value Set Constraint
1			CONTAINER	EV (18745-0, LN, "Cardiac Catheterization Report")	1	M		
2	>	HAS CONCEPT MOD	CODE	EV (121058, DCM, "Procedure reported")	1	M		DCID (3739) Cath Procedure Type
3	>	HAS CONCEPT MOD	INCLUDE	DTID (1204) Language of Content Item and Descendants	1	M		
4	>		INCLUDE	DTID (3601) Procedure Context	1	M		
5	>	CONTAINS	INCLUDE	DTID (3802) "Cardiovascular Patient History"	1	U		
6	>	CONTAINS	INCLUDE	DTID (3803) "Patient Presentation, Cath"	1	M		
7	>	CONTAINS	INCLUDE	DTID (3806) Cath Procedure	1	M		
8	>	CONTAINS	INCLUDE	DTID (3810) Cardiac Catheterization Findings	1	M		
9	>	CONTAINS	INCLUDE	DTID (3807) Percutaneous Coronary Intervention Procedure	1	U		
10	>	CONTAINS	INCLUDE	DTID (3809) Other Interventional Procedures	1-n	U		
11	>	CONTAINS	INCLUDE	DTID (3820) "Adverse Outcomes, Cath"	1	M		
12	>	CONTAINS	INCLUDE	DTID (3824) "Summary, Cath"	1	M		
13	>	CONTAINS	INCLUDE	DTID (3828) "Discharge Summary, Cath"	1	U		

**TID 3802 Cardiovascular Patient History**

This template contains information about a cardiovascular patient's past medical history. This information is considered to have some degree of "persistence" across different episodes.

**TID 3802**  
**Cardiovascular Patient History**  
**Type: Extensible**

	NL	Relation with Parent	Value Type	Concept Name	VM	Req Type	Condition	Value Set Constraint
1			CONTAINER	EV (121060, DCM, "History")	1	M		
2	>	CONTAINS	TEXT	EV (121060, DCM, "History")	1	U		
3	>	CONTAINS	CODE	DCID (3721) Cath Patient History	1-n	U		DCID (230) Yes-No
4	>	CONTAINS	CODE	DCID (3756) Cath Patient Risk Factors	1-n	U		DCID (240) Present-Absent

	NL	Relation with Parent	Value Type	Concept Name	VM	Req Type	Condition	Value Set Constraint
5	>	CONTAINS	DATE	DCID (3720) Cardiac History Dates	1-n	U		
6	>	CONTAINS	CODE	EV (36, NCDR [2.0b], "Previous Myocardial Infarction, > 1 week prior")	1	U		DCID (230) Yes-No
7	>>	HAS PROPERTIES	CODE	DT (122170, DCM, "Type of Myocardial Infarction")	1	U		DCID (3723) MI Types
8	>	CONTAINS	CODE	EV (31.1, NCDR [2.0b], "Diabetic Therapy")	1	U		DCID (3722) Diabetic Therapy
9	>	CONTAINS	CODE	EV (39.1, NCDR [2.0b], "Lipid Lowering Therapy")	1	U		DCID (230) Yes-No
10	>	CONTAINS	CODE	EV (38, NCDR [2.0b], "Smoking History")	1	U		DCID (3724) Smoking History
11	>	CONTAINS	COMPOSITE	EV (122075, DCM, "Prior report for current patient")	1-n	U		
12	>>	HAS PROPERTIES	CODE	EV (121144, DCM, "Document Title")	1	U		
13	>	CONTAINS	CONTAINER	DT (10160-2, LN, "History of Medications")	1	U		
14	>>	CONTAINS	TEXT	DT (111516, DCM, "Medication Type")	1-n	U		
15	>>>	HAS PROPERTIES	CODE	EV (111528, DCM, "Ongoing")	1	U		DCID (230) Yes-No
16	>>	CONTAINS	CODE	DT (111516, DCM, "Medication Type")	1-n	U		
17	>>>	HAS PROPERTIES	NUM	DT (G-C0B7, SRT, "Dosage")	1	U		
18	>>>	HAS PROPERTIES	CODE	EV (111528, DCM, "Ongoing")	1	U		DCID (230) Yes-No

**TID 3803 Patient Presentation, Cath**

This template describes the aspects of the patient that are specific to this clinical presentation (admission).

**TID 3803  
Patient Presentation, Cath  
Type: Extensible**

	NL	Relation with Parent	Value Type	Concept Name	VM	Req Type	Condition	Value Set Constraint
1			CONTAINER	EV (121110, DCM, "Patient Presentation")	1	M		
2	>	CONTAINS	TEXT	EV (122128, DCM, "Patient Transferred From")	1	U		
3	>	CONTAINS	DATETIME	EV (15, NCDR [2.0b], "Admission Date/Time")	1	U		
4	>	CONTAINS	CODE	EV (17, NCDR [2.0b], "Admission Status")	1	U		DCID (3729) Admission Status
5	>	CONTAINS	CODE	EV (18, NCDR [2.0b], "Insurance Payor Type")	1	U		DCID (3730), Insurance Payor
6	>	CONTAINS	CODE	EV (46, NCDR [2.0b], "Congestive Heart Failure Prior to Procedure")	1	U		DCID (230) Yes-No

	NL	Relation with Parent	Value Type	Concept Name	VM	Req Type	Condition	Value Set Constraint
7	>	CONTAINS	CODE	EV (47, NCDR [2.0b], "NYHA Classification")	1	UC	IFF Row 6 Value code meaning is <yes>	DCID (3736) NYHA Classification
8	>	CONTAINS	CODE	EV (48, NCDR [2.0b], "Noninvasive Testing - Ischemia")	1	U		DCID (3737) Non-Invasive Test - Ischemia
9	>	CONTAINS	CODE	EV (49, NCDR [2.0b], "Pre-Cath Angina Type")	1	U		DCID (3738) Pre-Cath Angina Type
10	>	CONTAINS	CODE	EV (50, NCDR [2.0b], "Pre-Cath Canadian Classification")	1	U		DCID (3719) Canadian Clinical Classification
11	>	CONTAINS	CODE	EV (51, NCDR [2.0b], "Acute Coronary Syndrome Time Period")	1	UC	IFF Row 9 Value code meaning is <ACS>	DCID (3735) Acute Coronary Syndrome Time Period
12	>	CONTAINS	CONTAINER	EV (121109, DCM, "Indications for Procedure")	1	U		
13	>>	CONTAINS	CODE	EV (121071, DCM, "Finding")	1-n	U		DCID (3727) Indications for Catheterization
14	>	CONTAINS	NUM	EV (10230-1, LN, "LV Ejection Fraction")	1-n	U		Units = EV (% , UCUM, "%")
15	>>	HAS CONCEPT MOD	CODE	EV (G-C036, SRT, "Measurement method")	1	U		DCID (3744) EF Testing Method
16	>>		INCLUDE	DTID (1000) Quotation	1	U		
17	>	CONTAINS	CODE	EV (121069, DCM, "Previous Finding")	1-n	U		DCID (3700) Cath Diagnosis
18	>	CONTAINS	TEXT	EV (121110, DCM, "Patient Presentation")	1	U		

**TID 3806 Cath Procedure**

This template describes the patient-related information about this specific clinical encounter (catheterization).

**TID 3806  
Cath Procedure  
Type: Extensible**

	NL	Relation with Parent	Value Type	Concept Name	VM	Req Type	Condition	Value Set Constraint
1			CONTAINER	EV (121064, DCM, "Current Procedure Descriptions")	1	M		
2	>	CONTAINS	DATETIME	EV (52, NCDR [2.0b], "Procedure DateTime")	1	M		
3	>	CONTAINS	TEXT	EV (53, NCDR [2.0b], "Procedure Number in this admission")	1	U		Up to three numeric characters
4	>	CONTAINS	TEXT	EV (121065, DCM, "Procedure Description")	1	U		
5	>	CONTAINS	COMPOSITE	EV (121120, DCM, "Cath Lab Procedure Log")	1-n	U		
6	>	CONTAINS	NUM	EV (55, NCDR [2.0b], "Fluoroscopy Time")	1	U		UNITS = DT (min, UCUM, "min")
7	>	CONTAINS	NUM	EV (122130, DCM, "Dose Area Product")	1	U		UNITS = DT (mGycm2, UCUM, "mGycm2")



	NL	Relation with Parent	Value Type	Concept Name	VM	Req Type	Condition	Value Set Constraint
8	>	CONTAINS	PNAME	EV (76, NCDR [2.0b], "Catheterization Operator")	1	M		
9	>	CONTAINS	PNAME	EV (121088, DCM, "Fellow")	1-n	U		
10	>	CONTAINS	PNAME	BCID (7453) Performing Roles	1-n	U		
11	>	CONTAINS	CODE	EV (122129, DCM, "PCI during this procedure")	1	U		DCID (230) Yes-No
12	>	CONTAINS	CONTAINER	EV (F-04460, "Medication Given")	1	M		
13	>>	CONTAINS	CODE	EV (57, NCDR [2.0b], "Thrombolytics")	1	U		DCID (3740) Thrombolytic Administration
14	>>	CONTAINS	CODE	EV (58, NCDR [2.0b], "Iib/IIla Blockade")	1	U		DCID (3741) Medication Administration, Lab Visit
15	>>	CONTAINS	CODE	EV (59, NCDR [2.0b], "Heparin")	1-n	U		DCID (3742) Medication Administration, PCI
16	>>	CONTAINS	CODE	EV (60, NCDR [2.0b], "Aspirin")	1	U		DCID (3741) Medication Administration, Lab Visit
17	>>	CONTAINS	CODE	EV (61, NCDR [2.0b], "Clopidogrel/Ticlopidine")	1	U		DCID (3743) Clopidogrel/Ticlopidine Administration
18	>>	CONTAINS	TEXT	EV (122083, DCM, "Drug administered")	1-n	U		
19	>	CONTAINS	CODE	EV (122138, DCM, "Circulatory Support")	1-n	U		DCID (3553) Circulatory Support
20	>	CONTAINS	CODE	EV (74, NCDR [2.0b], "Percutaneous Entry Site")	1	M		DCID (3746) Percutaneous Entry
21	>	CONTAINS	CODE	EV (75, NCDR [2.0b], "Closure Device")	1	U		DCID (3747) Percutaneous Closure

### Content Item Descriptions

Row 3 Procedure Number (this admission) is specified as a numeric text string, and shall be treated as the ordinal of this catheterization procedure within the admission (i.e., "1" for the first catheterization, "2" for the second, etc.).

### TID 3807 Percutaneous Coronary Intervention Procedure

This template describes the various aspects of a coronary intervention.

#### TID 3807 Percutaneous Coronary Intervention Procedure Type: Extensible

	NL	Relation with Parent	Value Type	Concept Name	VM	Req Type	Condition	Value Set Constraint
1			CONTAINER	EV (121064, DCM, "Current Procedure Descriptions")	1	M		
2	>	HAS CONCEPT MOD	CODE	EV (121058, DCM, "Procedure reported")	1	M		DT (122061, DCM, "Percutaneous Coronary Intervention")
3	>	CONTAINS	PNAME	EV (121114, DCM, "Performing Physician")	1	M		

	NL	Relation with Parent	Value Type	Concept Name	VM	Req Type	Condition	Value Set Constraint
4	>	CONTAINS	PNAME	EV (121088, DCM, "Fellow")	1-n	U		
5	>	CONTAINS	PNAME	DCID (7452) Organizational Roles	1-n	U		
6	>	CONTAINS	CODE	EV (G-C09C, SRT, "Procedure Priority")	1	M		DCID (3414) Procedure Urgency
7	>	CONTAINS	CONTAINER	EV (121109, DCM, "Indications for Procedure")	1	U		
8	>>	CONTAINS	CODE	EV (121071, DCM, "Finding")	1-n	U		DCID (3726) Indications for Coronary Intervention
9	>>	CONTAINS	CODE	EV (122172, DCM, "Acute MI Present")	1	U		DCID (230) Yes-No
10	>>>	HAS PROPERTIES	CODE	DT (122170, DCM, "Type of Myocardial Infarction")	1	U		DCID (3723) MI Types
11	>>>	HAS PROPERTIES	DATETIME	EV (122173, DCM, "ST Elevation Onset Datetime")	1	U		
12	>>	CONTAINS	TEXT	EV (121071, DCM, "Finding")	1-n	U		
13	>	CONTAINS	NUM	EV (122175, DCM, "Number of lesion interventions attempted")	1	M		UNITS = (1, UCUM, "units")
14	>	CONTAINS	NUM	EV (122176, DCM, "Number of lesion interventions successful")	1	M		UNITS = (1, UCUM, "units")
15	>	CONTAINS	CODE	EV (122177, DCM, "Procedure Result")	1	M		DCID (3749) PCI Procedure Result
16	>	CONTAINS	TEXT	EV (122177, DCM, "Procedure Result")	1	U		
17	>	CONTAINS	INCLUDE	DTID (3808) Lesion Intervention Information	1-n	M		

### Content Item Descriptions

Rows 8 and 12 allow the recording of findings as either codes or as text; the same finding shall not be recorded as both.

Similarly, rows 15 and 16 allow the recording of procedure results as either codes or as text, but not as both.

### TID 3808 Lesion Intervention Information

#### TID 3808 Lesion Intervention Information Type: Extensible

	NL	Relation with Parent	Value Type	Concept Name	VM	Req Type	Condition	Value Set Constraint
1			CONTAINER	EV (122178, DCM, "Lesion Intervention Information")	1	M		
2	>	CONTAINS	INCLUDE	DTID (3105) Lesion Identification and Properties	1	M		
3	>	CONTAINS	CODE	EV (108, NDR [2.0b, "Previous Dilatation")	1	U		DCID (3750) Previously Dilated Lesion
4	>	CONTAINS	CODE	EV (103, NDR [2.0b], "Guidewire crossing lesion")	1	U		DCID (3752) Guidewire Crossing

	NL	Relation with Parent	Value Type	Concept Name	VM	Req Type	Condition	Value Set Constraint
5	>	CONTAINS	CODE	EV (G-C50A, SRT, "Uses Equipment")	1-n	M		DCID (3411) Coronary Intervention Devices
6	>>	HAS CONCEPT MOD	CODE	EV (122111, DCM, "Primary Intervention Device")	1	MC	IF Device is Primary for this Lesion	DCID (230) Yes-No
7	>>	HAS PROPERTIES	TEXT	EV (121145, DCM, "Description of Material")	1	U		
8	>>	HAS PROPERTIES	NUM	DCID (3423) Numeric Device Characteristics	1-n	U		
9	>>	HAS PROPERTIES	NUM	DCID (3425) Intervention Parameters	1-n	U		
10	>>	HAS PROPERTIES	DATETIME	EV (122105, DCM, "DateTime of Intervention")	1	U		
11	>>	HAS PROPERTIES	NUM	EV (122106, DCM, "Duration of Intervention")	1	U		UNITS = EV (s, UCUM, "s")
12	>	CONTAINS	NUM	(R-101BB, SRT, "Lumen Diameter Stenosis")	1	M		UNITS = EV (% , UCUM, "%")
13	>>	HAS CONCEPT MOD	CODE	EV (G-72BB, SRT, "Catheterization Procedure Phase")	1	M		EV (G-7298, SRT, "Post-intervention Phase")
14	>>	HAS CONCEPT MOD	CODE	EV (121401, DCM, "Derivation")	1	U		DCID (3745) Calculation Method
15	>>		INCLUDE	DTID (1000) Quotation	1	U		
16	>	CONTAINS	CODE	EV (122110, DCM, "Post-Intervention TIMI Flow")	1	U		DCID (3713) TIMI Flow Characteristics
17	>	CONTAINS	CODE	EV (115, NCDR [2.0b], "Dissection in segment observed")	1	U		DCID (230) Yes-No
18	>	CONTAINS	CODE	EV (116, NCDR [2.0b], "Acute closure observed")	1	U		DCID (230) Yes-No
19	>	CONTAINS	CODE	EV (117, NCDR [2.0b], "Acute closure re-opened")	1	UC	IFF Row 18 value is <yes>	DCID (230) Yes-No
20	>	CONTAINS	CODE	EV (118, NCDR [2.0b], "Perforation occurred")	1	U		DCID (230) Yes-No
21	>	CONTAINS	IMAGE	DT (121080, DCM, "Best illustration of finding")	1	U		
22	>	CONTAINS	TEXT	DT (122177, DCM, "Procedure Result")	1	U		

**TID 3809 Other Interventional Procedures**

**TID 3809  
Other Interventional Procedures  
Type: Extensible**

	NL	Relation with Parent	Value Type	Concept Name	VM	Req Type	Condition	Value Set Constraint
1			CONTAINER	EV (121064, DCM, "Current Procedure Descriptions")	1	M		
2	>	HAS CONCEPT MOD	CODE	EV (121058, DCM, "Procedure reported")	1	M		BCID (3406) Non-Coronary Transcatheter Interventions

	NL	Relation with Parent	Value Type	Concept Name	VM	Req Type	Condition	Value Set Constraint
3	>	CONTAINS	TEXT	EV (121065, DCM, "Procedure Description")	1	U		
4	>	CONTAINS	CODE	DT (121065, DCM, "Procedure Description")	1	U		No BCID
5	>	CONTAINS	TEXT	DT (122177, DCM, "Procedure Result")	1	U		

**Content Item Descriptions**

Rows 3 and 4 allow the recording of procedure description as either code or as text; the same description shall not be recorded as both.

**TID 3810 Cardiac Catheterization Findings**

The Cardiac Catheterization Findings Template provides the structure for the diagnostic findings of the cath procedure, organized into sub-sections based on type of sub-procedure. It also provides for top-level summary findings and diagnoses.

**TID 3810  
Cardiac Catheterization Findings  
Type: Extensible**

	NL	Relation with Parent	Value Type	Concept Name	VM	Req Type	Condition	Value Set Constraint
1		CONTAINS	CONTAINER	EV (121070, DCM, "Findings")	1	M		
2	>	CONTAINS	INCLUDE	DTID (3812) Hemodynamic Findings	1	U		
3	>	CONTAINS	INCLUDE	DTID (3817) Coronary Arteriography Findings	1	U		
4	>	CONTAINS	INCLUDE	DTID (3814) Left Ventriculography Findings	1	U		
5	>	CONTAINS	INCLUDE	DTID (3815) Right Ventriculography Findings	1	U		
6	>	CONTAINS	INCLUDE	DTID (3818) Other Cardiographic Findings	1-n	U		
7	>	CONTAINS	CODE	EV (121071, DCM, "Finding")	1-n	U		DCID (3700) Cath Diagnosis
8	>>	HAS PROPERTIES	CODE	EV (G-C197, SRT, "Severity")	1	U		DCID (3716) Severity
9	>	CONTAINS	TEXT	EV (121071, DCM, "Finding")	1-n	U		

**Content Item Descriptions**

Rows 7 and 9 allow the recording of findings as either codes or as text; the same finding shall not be recorded as both.

**TID 3812 Hemodynamic Findings**

**TID 3812  
Hemodynamic Findings  
Type: Extensible**

	NL	Relation with Parent	Value Type	Concept Name	VM	Req Type	Condition	Value Set Constraint
1		CONTAINS	CONTAINER	EV (121070, DCM, "Findings")	1	M		
2	>	HAS CONCEPT MOD	CODE	EV (121058, DCM, "Procedure reported")	1	M		DT (PA-50030, SRT, "Hemodynamic measurements")
3	>	CONTAINS	CODE	EV (121071, DCM, "Finding")	1-n	U		DCID (3640) Hypertension
4	>>		INCLUDE	DTID (1350) "Negation Modifier, Presence of Finding"	1	U		
5	>>	HAS PROPERTIES	CODE	EV (G-C197, SRT, "Severity")	1	U		DCID (3716) Severity
6	>	CONTAINS	CODE	DCID (3641) Hemodynamic Assessments	1-n	U		DCID (3642) Degree Findings
7	>>	HAS PROPERTIES	CODE	EV (G-C0B2, SRT, "Condition")	1	U		EV (R-102B9, SRT, "Large v-wave")
8	>	CONTAINS	CODE	EV (121071, DCM, "Findings")	1	U		EV (R-102BA, SRT, "Diastolic pressure equalization")
9	>	CONTAINS	INCLUDE	DTID (3819) Common Findings	1-n	U		\$Report = DT (122120, DCM, "Hemodynamics Report")

**Content Item Descriptions**

Row 4 (through DTID 3819 Common Findings Template) may be used to encode any significant hemodynamic numeric measurements. For reference, see Templates 3550 Pressure Waveform Measurements, and 3560 Derived Hemodynamic Measurements.

**TID 3814 Left Ventriculography Findings**

The information contained here about the left ventricle is relatively qualitative in nature. It is a high-level summary of the more detailed information that may be contained in an optional Quantitative Ventricular Analysis report. This template addresses findings about any ventricular septal defect (Row 7), the myocardial wall (Row 11), and about the aortic root (Row 16).

**TID 3814  
Left Ventriculography Findings  
Type: Extensible**

	NL	Relation with Parent	Value Type	Concept Name	VM	Req Type	Condition	Value Set Constraint
1		CONTAINS	CONTAINER	EV (121070, DCM, "Findings")	1	M		
2	>	HAS CONCEPT MOD	CODE	EV (121058, DCM, "Procedure reported")	1	M		DT (P5-30041, SRT, "Left Ventriculography")
3	>	CONTAINS	CODE	EV ( F-30117, SRT, "Left Ventricular Function -	1	M		DCID (242) Normal-Abnormal

	NL	Relation with Parent	Value Type	Concept Name	VM	Req Type	Condition	Value Set Constraint
				Finding")				
4	>		INCLUDE	TID (300) Measurement	1	M		\$Measurement = EV (10230-1, LN, "LV Ejection Fraction") \$Units = EV (% , UCUM, "%") \$Method = DCID (3748) Angiographic EF Testing Method \$Derivation = DCID (3745) Calculation Method
5	>	CONTAINS	CODE	EV (F-0224E, SRT, "Left Ventricular Cavity Size")	1	U		DCID (3705) Chamber Size
6	>	CONTAINS	CODE	EV (F-02225, SRT, "Left Ventricular Contractility")	1	U		DCID (3706) Overall Contractility
7	>	CONTAINS	CODE	EV (121071, DCM, "Finding")	1	U		EV (D4-31159, SRT, "Ventricular Septal Defect")
8	>>	HAS PROPERTIES	CODE	EV (G-C504, SRT, "Associated Morphology")	1	U		DCID (3707) VSD Description
9	>	CONTAINS	INCLUDE	DTID (3816) Ventricular Assessment	1	U		
10	>	CONTAINS	CONTAINER	EV (121070, DCM, "Findings")	1	U		
11	>>	HAS CONCEPT MOD	CODE	EV (G-C0E3, SRT, "Finding Site")	1	M		DT (T-D0772, SRT, "Myocardial Wall")
12	>>	CONTAINS	CODE	EV (LN, 18179-2, "Wall Segment")	1-n	M		BCID (3717) Myocardial Wall Segments
13	>>>	HAS PROPERTIES	CODE	EV (F-32050, SRT, "Cardiac Wall Motion")	1	M		DCID (3703) Wall Motion
14	>>>	HAS PROPERTIES	CODE	EV (G-C504, SRT, "Associated Morphology")	1	U		DCID (3704) Myocardium Wall Morphology Findings
15	>>>	HAS PROPERTIES	NUM	DT (G-C1E3, SRT, "Score")	1	U		
16	>	CONTAINS	CONTAINER	EV (121070, DCM, "Findings")	1	U		
17	>>	HAS CONCEPT MOD	CODE	EV (G-C0E3, SRT, "Finding Site")	1	M		DT (F-04403, SRT, "Aortic Root")
18	>>	CONTAINS	CODE	EV (121071, DCM, "Finding")	1-n	M		DCID (3709) Aortic Root Description

**TID 3815 Right Ventriculography Findings**

The information contained here about right ventricle is relatively qualitative in nature. It is a high-level summary of the more detailed information that may be contained in an optional Quantitative Ventricular Analysis report.

**TID 3815  
Right Ventriculography Findings  
Type: Extensible**

	NL	Relation with Parent	Value Type	Concept Name	VM	Req Type	Condition	Value Set Constraint
1		CONTAINS	CONTAINER	EV (121070, DCM, "Findings")	1	M		

	NL	Relation with Parent	Value Type	Concept Name	VM	Req Type	Condition	Value Set Constraint
2	>	HAS CONCEPT MOD	CODE	EV (121058, DCM, "Procedure reported")	1	M		DT (P5-3003F, SRT, "Right Ventriculography")
3	>		INCLUDE	TID (300) Measurement	1	M		\$Measurement = EV (10231-9, LN, "RV Ejection Fraction") \$Units = EV (% , UCUM, "%") \$Method = DCID (3748) Angiographic EF Testing Method \$Derivation = DCID (3745) Calculation Method
4	>	CONTAINS	CODE	EV (F-022A1, SRT, "Right Ventricular Cavity Size")	1	U		DCID (3705) Chamber Size
5	>	CONTAINS	CODE	EV (F-0227A, "Right Ventricular Contractility")	1	U		DCID (3706) Overall Contractility
6	>	CONTAINS	INCLUDE	DTID (3816) Ventricular Assessment	1	U		

**TID 3816 Ventricular Assessment**

**TID 3816  
Ventricular Assessment  
Type: Extensible**

	NL	Relation with Parent	Value Type	Concept Name	VM	Req Type	Condition	Value Set Constraint
1		CONTAINS	CONTAINER	EV (121070, DCM, "Findings")	1-n	U		
2	>	HAS CONCEPT MOD	CODE	EV (G-C0E3, SRT, "Finding Site")	1	M		DCID (3701) Cardiac Valves and Tracts
3	>	CONTAINS	CODE	EV (121071, DCM, "Finding")	1-n	M		DCID (3711) Valvular Abnormalities
4	>>	HAS PROPERTIES	CODE	EV (G-C197, SRT, "Severity")	1	U		DCID (3716) Severity
5	>>	HAS PROPERTIES	NUM	DT (G-C1E3, SRT, "Score")	1	U		
6		CONTAINS	INCLUDE	DTID (3819) Common Findings	1-n	U		\$Report = DT (122292, DCM, "Quantitative Ventriculography Report")

**TID 3817 Coronary Arteriography Findings**

The information contained here about with regards to coronary artery lesions is relatively qualitative in nature. It is a high-level summary of the more detailed information that may be contained in an optional Quantitative Coronary Arteriography report. This template addresses findings about the individual arteries (Row 4), and about individual lesions (Row 9).

**TID 3817**  
**Coronary Arteriography Findings**  
**Type: Extensible**

	NL	Relation with Parent	Value Type	Concept Name	VM	Req Type	Condition	Value Set Constraint
1		CONTAINS	CONTAINER	EV (121070, DCM, "Findings")	1	M		
2	>	HAS CONCEPT MOD	CODE	EV (121058, DCM, "Procedure reported")	1	M		DT (P5-30100, SRT, "Coronary Arteriography")
3	>	CONTAINS	CODE	EV (68, NCDR[2.0b], "Coronary Dominance")	1	U		DCID (3710) Coronary Dominance
4	>	CONTAINS	CONTAINER	EV (121070, DCM, "Findings")	1-n	U		
5	>>	HAS CONCEPT MOD	CODE	EV (G-C0E3, SRT, "Finding Site")	1	M		BCID (3015) Coronary Arteries
6	>>>	HAS CONCEPT MOD	CODE	EV (G-A1F8, SRT, "Topographical modifier")	1	U		BCID (3019) Cardiovascular Anatomic Location Modifiers
7	>>	CONTAINS	CODE	EV (122134, DCM, "Vessel Morphology")	1-n	U		DCID (3712) Vessel Descriptors
8	>>	CONTAINS	INCLUDE	DTID (3819) Common Findings	1-n	U		
9	>	CONTAINS	CONTAINER	EV (121070, DCM, "Findings")	1-n	U		
10	>>	HAS CONCEPT MOD	CODE	EV (G-C0E3, SRT, "Finding Site")	1	M		DT (R-002EF, SRT, "Coronary artery lesion (culprit)")
11	>>	CONTAINS	INCLUDE	DTID (3105) Lesion Identification and Properties	1	M		
12	>>	CONTAINS	INCLUDE	DTID (3819) Common Findings	1-n	U		\$Report = DT (122291, DCM, "Quantitative Arteriography Report")

**TID 3818**      **Other Cardiographic Findings**

**TID 3818**  
**Other Cardiographic Findings**  
**Type: Extensible**

	NL	Relation with Parent	Value Type	Concept Name	VM	Req Type	Condition	Value Set Constraint
1		CONTAINS	CONTAINER	EV (121070, DCM, "Findings")	1	M		
2	>	HAS CONCEPT MOD	CODE	EV (121058, DCM, "Procedure reported")	1	M		BCID (3428) Imaging Procedures
3	>	HAS CONCEPT MOD	CODE	EV (G-C0E3, SRT, "Finding Site")	1	U		BCID (3630) Cardiovascular Anatomic Locations
4	>	CONTAINS	INCLUDE	DTID (3819) Common Findings	1-n	M		



**TID 3819 Common Findings**

**TID 3819 Parameters**

Parameter Name	Parameter Usage
\$Report	Title of composite object (evidence document) referenced

**TID 3819  
Common Findings  
Type: Extensible**

	NL	Relation with Parent	Value Type	Concept Name	VM	Req Type	Condition	Value Set Constraint
1			TEXT	EV (121071, DCM, "Finding")	1	U		
2			IMAGE	DT (121080, DCM, "Best illustration of finding")	1	U		
3			NUM	No BCID	1	U		
4	>		INCLUDE	DTID (1000) Quotation	1	U		
5			COMPOSITE	DT (122073, DCM, "Current procedure evidence")	1	U		
6	>	HAS PROPERTIES	CODE	EV (121144, DCM, "Document Title")	1	U		\$Report

**Content Item Descriptions**

Row 3 may be used to encode any significant image- or waveform-based numeric measurements, with post-coordination of the Concept Name using child Content Items (with relationship HAS CONCEPT MOD), as permitted by Section 6.2.4. The source of the measurement may be noted using the Quotation Template in Row 4.

**TID 3820 Adverse Outcomes, Cath**

**TID 3820  
Adverse Outcomes, Cath  
Type: Extensible**

	NL	Relation with Parent	Value Type	Concept Name	VM	Req Type	Condition	Value Set Constraint
1			CONTAINER	EV (121113, DCM, "Complications")	1	M		
2	>	CONTAINS	CODE	EV (DD-60002, SRT, "Complication of Procedure")	1-n	U		DCID (3755) Cath Complications
3	>>	HAS CONCEPT MOD	CODE	EV (G-D709, SRT, "Relative Time")	1	U		DCID (12102) Temporal Periods Relating to Procedure or Therapy
4	>	CONTAINS	CODE	EV (DD-60002, SRT, "Complication of Procedure")	1-n	U		DCID (3754) Vascular Complications
5	>>	HAS CONCEPT MOD	CODE	EV (G-D709, SRT, "Relative Time")	1	U		DCID (12102) Temporal Periods Relating to Procedure

	NL	Relation with Parent	Value Type	Concept Name	VM	Req Type	Condition	Value Set Constraint
		MOD						or Therapy
6	>	CONTAINS	TEXT	EV (DD-60002, SRT, "Complication of Procedure")	1-n	U		
7	>	CONTAINS	CODE	EV (122179, DCM, "Peri-procedural MI occurred")	1	U		DCID (230) Yes-No
8	>>	INFERRED FROM	NUM	EV (122181, DCM, "CK-MB peak")	1	U		UNITS = EV ([iU], UCUM, "International unit")
9	>>>	HAS PROPERTIES	NUM	EV (R-0038B, SRT, "Normal Range Upper Limit")	1	M		UNITS = EV ([iU], UCUM, "International unit")
10	>>	INFERRED FROM	NUM	EV (122180, DCM, "CK-MB baseline")	1	M		UNITS = EV ([iU], UCUM, "International unit")
11	>	CONTAINS	IMAGE	DT (121080, DCM, "Best illustration of finding")	1-n	U		

**Content Item Descriptions**

Rows 2, 3 and 4 allow the recording of outcomes as either codes or as text; the same outcome shall not be recorded as both.

**TID 3824 Summary, Cath**

**TID 3824  
Summary, Cath  
Type: Extensible**

	NL	Relation with Parent	Value Type	Concept Name	VM	Req Type	Condition	Value Set Constraint
1		CONTAINS	CONTAINER	EV (121111, DCM, "Summary")	1	M		
2	>	CONTAINS	CODE	EV (121071, DCM, "Finding")	1-n	U		DCID (3728) Cath Findings
3	>>	HAS PROPERTIES	CODE	EV (G-C197, SRT, "Severity")	1	U		DCID (3716) Severity
4	>	CONTAINS	TEXT	EV (121111, DCM, "Summary")	1	U		
5	>	CONTAINS	TEXT	EV (121075, DCM, "Recommendation")	1-n	U		

**TID 3828 Discharge Summary, Cath**

**TID 3828  
Discharge Summary, Cath  
Type: Extensible**

	NL	Relation with Parent	Value Type	Concept Name	VM	Req Type	Condition	Value Set Constraint
1		CONTAINS	CONTAINER	EV (121115, DCM, "Discharge Summary")	1	M		
2	>	CONTAINS	DATETIME	EV (122163, DCM, "Discharge DateTime")	1	U		

	NL	Relation with Parent	Value Type	Concept Name	VM	Req Type	Condition	Value Set Constraint
3	>	CONTAINS	CODE	EV (122164, DCM, "Coronary Artery Bypass During This Admission")	1	U		DCID (230) Yes-No
4	>>	HAS PROPERTIES	CODE	EV (G-C09C, SRT, "Procedure Priority")	1	U		BCID (3414) Procedure Urgency
5	>>	HAS PROPERTIES	DATETIME	EV (122146, DCM, "Procedure Datetime")	1	U		
6	>	CONTAINS	CODE	EV (122166, DCM, "Death During This Admission")	1	U		DCID (230) Yes-No
7	>>	HAS PROPERTIES	DATETIME	EV (122165, DCM, "Date of Death")	1	U		
8	>>	HAS PROPERTIES	CODE	EV (25, NCDR [2.0b], "Primary Cause of Death")	1	U		DCID (3733) Primary Cause of Death
9	>>	HAS PROPERTIES	CODE	EV (122167, DCM, "Death During Catheterization")	1	U		DCID (230) Yes-No
10	>	CONTAINS	TEXT	EV (121111, DCM, "Summary")	1	U		

**CT/MR CARDIOVASCULAR ANALYSIS REPORT TEMPLATES**

**TID 3900 CT/MR Cardiovascular Analysis Report**

Root Template of the Non-invasive Computed Tomography and Magnetic Resonance Cardiovascular Analysis Report.

This template contains the top level structure and includes sub-templates for the various analyses.

**TID 3900  
CT/MR Cardiovascular Analysis Report  
Type: Extensible**

NL	Rel with Parent	VT	Concept Name	VM	Req Type	Condition	Value Set Constraint
1		CONTAINER	EV (122600, DCM, "Cardiovascular Analysis Report")	1	M		
2	>	HAS CONCEPT MOD	CODE EV(121058, DCM, "Procedure Reported")	1-n	M		DCID(3820) Non-invasive Vascular Procedures
3	>	HAS CONCEPT MOD	INCLUDE DTID (1204) Language of Content Item and Descendants	1	M		
4	>	HAS OBS CONTEXT	INCLUDE DTID (1001) Observation Context	1	M		
5	>	CONTAINS	INCLUDE DTID (3602) Cardiovascular Patient Characteristics	1	U		
6	>	CONTAINS	INCLUDE DTID (3802) Patient History, Cardiovascular	1	U		
7	>	CONTAINS	INCLUDE DTID (3901) Procedure Summary	1	U		
8	>	CONTAINS	INCLUDE DTID (3902) Vascular Analysis	1	U		\$AnalysisPerformed = EV(122605, DCM, "Vascular Morphological Analysis")
9	>	CONTAINS	INCLUDE DTID (3902) Vascular Analysis	1	U		\$AnalysisPerformed = EV(122606, DCM, "Vascular Functional Analysis")
10	>	CONTAINS	INCLUDE DTID (3920) Ventricular Analysis	1	U		
11	>	CONTAINS	INCLUDE DTID (3927) Report Summary	1-n	U		

**TID 3901 Procedure Summary**

Contains summaries related to the performed procedures.

**TID 3901  
Procedure Summary  
Type: Extensible**

NL	Rel with Parent	VT	Concept Name	VM	Req Type	Condition	Value Set Constraint
1		CONTAINS	CONTAINER EV(121064, DCM, "Current Procedure Descriptions")	1	M		
2	>	CONTAINS	TEXT EV(121065, DCM, "Current Procedure Description")	1-n	M		

**TID 3902 Vascular Analysis**

Contains either morphological or functional vascular measurement results of an analysis

**TID 3902**  
**Vascular Analysis**  
**Type: Extensible**

	NL	Rel with Parent	VT	Concept Name	VM	Req Type	Condition	Value Set Constraint
1			CONTAINER	EV (121070, DCM, "Findings")	1	M		
2	>	HAS CONCEPT MOD	CODE	EV(111004, DCM, "Analysis Performed")	1	M		\$AnalysisPerformed
3	>	CONTAINS	INCLUDE	DTID (3905) Calcium Scoring Results	1	UC	IFF the value of row 2 equals EV(122605, DCM, "Vascular Morphological Analysis")	
4	>	CONTAINS	INCLUDE	DTID (3906) Vascular Section Measurements	1-n	U		\$VascularSection = DT (T-40501, SRT, "Blood Vessel of Head") \$SectionLaterality = EV (G-A101, SRT, "Left") \$Anatomy = DCID (12105) Intracranial Cerebral Vessels \$AnalysisPerformed = \$AnalysisPerformed
5	>	CONTAINS	INCLUDE	DTID (3906) Vascular Section Measurements	1-n	U		\$VascularSection = DT (T-40501, SRT, "Blood Vessel of Head") \$SectionLaterality = EV (G-A100, SRT, "Right") \$Anatomy = DCID (12105) Intracranial Cerebral Vessels \$AnalysisPerformed = \$AnalysisPerformed
6	>	CONTAINS	INCLUDE	DTID (3906) Vascular Section Measurements	1-n	U		\$VascularSection = DT (T-40501, SRT, "Blood Vessel of Head") \$SectionLaterality = EV (G-A103, SRT, "Unilateral") \$Anatomy = DCID (12106) Unpaired Intracranial Cerebral Vessels (unilateral) \$AnalysisPerformed = \$AnalysisPerformed
7	>	CONTAINS	INCLUDE	DTID (3906) Vascular Section Measurements	1-n	U		\$VascularSection = DT(T-45005, SRT, "Artery of Neck") \$SectionLaterality = EV (G-A101, SRT, "Left") \$Anatomy = DCID (12104) Extracranial Arteries \$AnalysisPerformed = \$AnalysisPerformed
8	>	CONTAINS	INCLUDE	DTID (3906) Vascular Section Measurements	1-n	U		\$VascularSection = DT(T-45005, SRT, "Artery of Neck") \$SectionLaterality = EV (G-A100, SRT, "Right") \$Anatomy = DCID (12104) Extracranial Arteries \$AnalysisPerformed = \$AnalysisPerformed
9	>	CONTAINS	INCLUDE	DTID (3906) Vascular Section Measurements	1-n	U		\$VascularSection = DT(T-47040, SRT, "Artery of Lower Extremity") \$SectionLaterality = EV (G-A101, SRT, "Left") \$Anatomy = DCID (12109) Lower Extremity Arteries \$AnalysisPerformed = \$AnalysisPerformed
10	>	CONTAINS	INCLUDE	DTID (3906) Vascular Section Measurements	1-n	U		\$VascularSection = DT(T-47040, SRT, "Artery of Lower Extremity") \$SectionLaterality = EV (G-A100, SRT, "Right") \$Anatomy = DCID (12109) Lower Extremity Arteries \$AnalysisPerformed = \$AnalysisPerformed
11	>	CONTAINS	INCLUDE	DTID (3906) Vascular Section Measurements	1-n	U		\$VascularSection = DT (T-49403, SRT, "Vein of Lower Extremity") \$SectionLaterality = EV (G-A101, SRT, "Left") \$Anatomy = DCID (12110) Lower Extremity Veins \$AnalysisPerformed = \$AnalysisPerformed
12	>	CONTAINS	INCLUDE	DTID (3906) Vascular Section Measurements	1-n	U		\$VascularSection = DT (T-49403, SRT, "Vein of Lower Extremity") \$SectionLaterality = EV (G-A100, SRT, "Right") \$Anatomy = DCID (12110) Lower Extremity Veins \$AnalysisPerformed = \$AnalysisPerformed

	NL	Rel with Parent	VT	Concept Name	VM	Req Type	Condition	Value Set Constraint
13	>	CONTAINS	INCLUDE	DTID (3906) Vascular Section Measurements	1-n	U		\$VascularSection = DT (T-47020, SRT, "Artery of Upper Extremity") \$SectionLaterality = EV (G-A101, SRT, "Left") \$Anatomy = DCID (12107) Upper Extremity Arteries \$AnalysisPerformed = \$AnalysisPerformed
14	>	CONTAINS	INCLUDE	DTID (3906) Vascular Section Measurements	1-n	U		\$VascularSection = DT (T-47020, SRT, "Artery of Upper Extremity") \$SectionLaterality = EV (G-A100, SRT, "Right") \$Anatomy = DCID (12107) Upper Extremity Arteries \$AnalysisPerformed = \$AnalysisPerformed
15	>	CONTAINS	INCLUDE	DTID (3906) Vascular Section Measurements	1-n	U		\$VascularSection = DT (T-49103, SRT, "Vein of Upper Extremity") \$SectionLaterality = EV (G-A101, SRT, "Left") \$Anatomy = DCID (12108) Upper Extremity Veins \$AnalysisPerformed = \$AnalysisPerformed
16	>	CONTAINS	INCLUDE	DTID (3906) Vascular Section Measurements	1-n	U		\$VascularSection = DT (T-49103, SRT, "Vein of Upper Extremity") \$SectionLaterality = EV (G-A100, SRT, "Right") \$Anatomy = DCID (12108) Upper Extremity Veins \$AnalysisPerformed = \$AnalysisPerformed
17	>	CONTAINS	INCLUDE	DTID (3906) Vascular Section Measurements	1-n	U		\$VascularSection = DT (T-71019, SRT, "Vascular Structure of Kidney") \$SectionLaterality = EV (G-A101, SRT, "Left") \$Anatomy = DCID (12115) Renal Vessels \$AnalysisPerformed = \$AnalysisPerformed
18	>	CONTAINS	INCLUDE	DTID (3906) Vascular Section Measurements	1-n	U		\$VascularSection = DT (T-71019, SRT, "Vascular Structure of Kidney") \$SectionLaterality = EV (G-A100, SRT, "Right") \$Anatomy = DCID (12115) Renal Vessels \$AnalysisPerformed = \$AnalysisPerformed
19	>	CONTAINS	INCLUDE	DTID (3906) Vascular Section Measurements	1-n	U		\$VascularSection = DT (T-46002, SRT, "Artery of Abdomen") \$SectionLaterality = EV(G-A101, SRT, "Left") \$Anatomy = DCID (12111) Abdominal Arteries (lateral) \$AnalysisPerformed = \$AnalysisPerformed
20	>	CONTAINS	INCLUDE	DTID (3906) Vascular Section Measurements	1-n	U		\$VascularSection = DT (T-46002, SRT, "Artery of Abdomen") \$SectionLaterality = EV (G-A100, SRT, "Right") \$Anatomy = DCID (12111) Abdominal Arteries (lateral) \$AnalysisPerformed = \$AnalysisPerformed
21	>	CONTAINS	INCLUDE	DTID (3906) Vascular Section Measurements	1-n	U		\$VascularSection = DT (T-46002, SRT, "Artery of Abdomen") \$SectionLaterality = EV (G-A103, SRT, "Unilateral") \$Anatomy = DCID (12112) Abdominal Arteries (unilateral) \$AnalysisPerformed = \$AnalysisPerformed
22	>	CONTAINS	INCLUDE	DTID (3906) Vascular Section Measurements	1-n	U		\$VascularSection = DT (T-487A0, SRT, "Vein of Abdomen") \$SectionLaterality = EV (G-A101, SRT, "Left") \$Anatomy = DCID (12113) Abdominal Veins (lateral) \$AnalysisPerformed = \$AnalysisPerformed
23	>	CONTAINS	INCLUDE	DTID (3906) Vascular Section Measurements	1-n	U		\$VascularSection = DT (T-487A0, SRT, "Vein of Abdomen") \$SectionLaterality = EV (G-A100, SRT, "Right") \$Anatomy = DCID (12113) Abdominal Veins (lateral) \$AnalysisPerformed = \$AnalysisPerformed
24	>	CONTAINS	INCLUDE	DTID (3906) Vascular Section Measurements	1-n	U		\$VascularSection = DT (T-487A0, SRT, "Vein of Abdomen") \$SectionLaterality = EV (G-A103, SRT,

	NL	Rel with Parent	VT	Concept Name	VM	Req Type	Condition	Value Set Constraint
								"Unilateral") \$Anatomy = DCID (12114) Abdominal Veins (unilateral) \$AnalysisPerformed = \$AnalysisPerformed
25	>	CONTAINS	INCLUDE	DTID (3906) Vascular Section Measurements	1-n	U		\$VascularSection = DT (T-44000, SRT, "Pulmonary Artery Structure") \$SectionLaterality = EV (G-A103, SRT, "Unilateral") \$Anatomy = DCID (3829) Pulmonary Arteries \$AnalysisPerformed = \$AnalysisPerformed
26	>	CONTAINS	INCLUDE	DTID (3906) Vascular Section Measurements	1-n	U		\$VascularSection = DT(T-43000, SRT, "Coronary Artery Structure") \$Anatomy = DCID(3015) Coronary Arteries \$AnalysisPerformed = \$AnalysisPerformed
27	>	CONTAINS	INCLUDE	DTID (3906) Vascular Section Measurements	1-n	U		\$VascularSection = DT(T-48400, SRT, "Cardiac Vein Structure") \$Anatomy = DCID(3839) Coronary Veins \$AnalysisPerformed = \$AnalysisPerformed
28	>	CONTAINS	INCLUDE	DTID (3906) Vascular Section Measurements	1-n	U		\$VascularSection = DT(T-48581, SRT, "Pulmonary Venous Structure") \$Anatomy = DCID(3840) Pulmonary Veins \$AnalysisPerformed = \$AnalysisPerformed

### TID 3905 Calcium Scoring Results

Contains the calcium scoring results related to plaque findings, vessels or the whole body.

### TID 3905 Calcium Scoring Results Type: Extensible

	NL	Rel with Parent	VT	Concept Name	VM	Req Type	Condition	Value Set Constraint
1			CONTAINER	EV (121070, DCM, "Findings")	1	M		
2	>	CONTAINS	CODE	EV(111004, DCM, "Analysis Performed")	1	M		EV(122603, DCM, "Calcium Scoring Analysis")
3	>	CONTAINS	NUM	EV(122657, DCM, "Agatston Score Threshold")	1	U		Units= DT([hnsf U], UCUM, "Hounsfield unit")
4	>	CONTAINS	NUM	EV(122658, DCM, "Calcium Mass Threshold")	1	U		Units= DT(mg/cm3, UCUM, "mg/cm^3")
5	>	CONTAINS	NUM	EV(122659, DCM, "Calcium Scoring Calibration")	1	U		Units= DT(mg/[hnsf U]cm3), UCUM, "mg/[hnsf U]cm^3")
6	>	CONTAINS	INCLUDE	DTID(300) Measurement	1	U		\$Measurement=EV(112058, DCM, "Calcium Score") \$Method=EV(112055, DCM, "Agatston Scoring Method") \$Units= DT (1, UCUM, "no units")
7	>	CONTAINS	NUM	EV(122660, DCM, "Calcium Volume")	1	U		Units= UCUM(mm3, UCUM, "mm^3")
8	>	CONTAINS	NUM	EV(122661, DCM, "Calcium Mass")	1	U		Units= UCUM(mg, UCUM, "mg")
9	>	CONTAINS	NUM	EV(F-02A3B, SRT, "Number of Lesions")	1	U		Units= DT ({lesions}, UCUM, "lesions")

**TID 3906 Vascular Section Measurements**

Sections of vascular measurements are section containers of an anatomical region consisting of measurement group containers containing the measurements.

Parameter Name	Parameter Usage
\$VascularSection	The concept name of the region or structure of which the anatomy is part
\$SectionLaterality	The laterality (if any) of the anatomy in this section heading
\$Anatomy	The concept name of the vascular anatomy
\$AnalysisPerformed	The context of the measurements performed during the analysis

**TID 3906**  
**Vascular Section Measurements**  
**Type: Extensible**

NL	Rel with Parent	VT	Concept Name	VM	Req Type	Condition	Value Set Constraint
1	CONTAINS	CONTAINER	\$VascularSection	1	M		
2 >	HAS CONCEPT MOD	CODE	EV (G-C171, SRT, "Laterality")	1	MC	IFF \$SectionLaterality has a value	\$SectionLaterality
3 >	CONTAINS	CONTAINER	EV (121070, DCM, "Findings")	1-n	M		
4 >	HAS CONCEPT MOD	CODE	EV(G-C0E3, SRT, "Finding Site")	1	M		\$Anatomy
5 >>	CONTAINS	CODE	EV(122686, DCM, "Parent Vessel Finding")	1-n	U		DCID(3810) Vascular Morphology
6 >>>		INCLUDE	DTID (1350) Negation Modifier, Presence of Finding	1	U		
7 >>	CONTAINS	INCLUDE	DTID (3905) Calcium Scoring Results	1	UC	IF the value of \$AnalysisPerformed equals (122605, DCM, "Vascular Morphological Analysis")	
8 >>	CONTAINS	CONTAINER	EV (121070, DCM, "Findings")	1-n	M		
9 >>>	HAS CONCEPT MOD	CODE	EV (125101, DCM, "Vessel Branch")	1-n	UC	IF concept value of row 4 is not equal to (T-43000, SRT, "Coronary Artery Structure")	DCID (12117) Vessel Branch Modifiers
10 >>>	HAS CONCEPT MOD	CODE	EV (G-A1F8, SRT, "Topographical Modifier")	1	UC	IF concept value of row 4 is not equal to (T-43000, SRT, "Coronary Artery Structure")	DCID (12116) Vessel Segment Modifiers
11 >>>	HAS CONCEPT MOD	CODE	EV (G-A1F8, SRT, "Topographical Modifier")	1	UC	IF concept value of row 4 equals (T-43000, SRT, "Coronary Artery Structure")	DCID(3019) Cardiovascular Anatomic Location Modifiers
12 >>>	CONTAINS	INCLUDE	DTID (3907) Vessel Measurements	1	U		
13 >>>	CONTAINS	INCLUDE	DTID (3908) Vascular Lesion	1-n	UC	IF the value of \$AnalysisPerformed equals (122605, DCM, "Vascular Morphological Analysis")	
14 >>>	CONTAINS	INCLUDE	DTID (3910) Flow Quantification	1	UC	IF the value of \$AnalysisPerformed equals (122606, DCM, "Vascular Functional Analysis")	



**Content Item Descriptions**

Row 3	This Findings container allows an application to group related vessels or branches
Row 5	The characteristics associated with the parent vessel shall also be reported in the findings Container for the parent vessel. Negative findings (characteristics not present) need not be reported in the parent vessel Container.

**TID 3907 Vessel Measurements**

Contains measurements made on vessel level.

**TID 3907  
Vessel Measurements  
Type: Extensible**

NL	Rel with Parent	VT	Concept Name	VM	Req Type	Condition	Value Set Constraint
1	CONTAINS	NUM	EV(R-101BB, SRT, "Lumen Diameter Stenosis")	1	U		UNITS=DT(% , UCUM, "%")
2	CONTAINS	NUM	EV(R-101BA, SRT, "Lumen Area Stenosis")	1	U		UNITS=DT(% , UCUM, "%")
3	CONTAINS	NUM	EV(121206, DCM, "Distance")	1-n	U		UNITS=DT(mm, UCUM, "mm")
4	> HAS CONCEPT MOD	CODE	EV(122340, DCM, "Fiducial Feature")	2	M		
5	>> HAS CONCEPT MOD	CODE	EV(G-C171, SRT, "Laterality")	1	U		DCID(244) Laterality
6	>	INCLUDE	DTID (320) Image or Spatial Coordinates	1	U		
7	CONTAINS	NUM	EV(G-0364, SRT, "Vessel Lumen Diameter")	1-n	U		UNITS=DT(mm, UCUM, "mm")
8	> HAS CONCEPT MOD	CODE	EV (121401, DCM, "Derivation")	1	U		DCID(3488) Min/Max/Mean
9	> HAS CONCEPT MOD	NUM	EV(122337, DCM, "Relative Position")	1	M		Units=EV(mm, UCUM, "mm")
10	>> HAS CONCEPT MOD	CODE	EV(122340, DCM, "Fiducial Feature")	1	M		DCID(3837) Fiducial Feature

**Content Item Descriptions**

Rows 3-5	The distance between two identified fiducial features
Rows 7-10	Measurement of vessel diameter made at a position relative to a fiducial feature
Row 9	A positive value indicates a distance in the direction of flow within the vessel

**TID 3908 Vascular Lesion**

Specifies properties and the features of a vascular lesion detected during the analysis. In addition it is possible to reference or include growing of lesions over time by adding references to previous reports or by adding previous examination results.

**TID 3908  
Vascular Lesion  
Type: Extensible**

- Standard -

	NL	Rel with Parent	VT	Concept Name	VM	Req Type	Condition	Value Set Constraint
1		CONTAINS	CONTAINER	EV(F-00585, SRT, "Lesion Finding")	1	M		
2	>	CONTAINS	TEXT	EV(121151, DCM, "Lesion Identifier")	1	M		
3	>	CONTAINS	INCLUDE	DTID(3909) Best Illustration of Findings	1-n	U		
4	>	CONTAINS	TEXT	EV(121106, DCM, "Comment")	1-n	U		
5	>	CONTAINS	NUM	EV(122337, DCM, "Relative Position")	1	U		Units=EV(mm, UCUM, "mm")
6	>>	HAS CONCEPT MOD	CODE	EV(122340, DCM, "Fiducial Feature")	1	M		DCID(3837) Fiducial Feature
7	>	CONTAINS	INCLUDE	DTID(300) Measurement	1-n	U		\$Measurement= EV(G-0364, SRT, "Vessel Lumen Diameter") \$Derivation=DCID(3838) Diameter Derivation \$FindingSite=DCID(3486) IVUS Measurement Sites \$Units=DT(mm, UCUM, "mm")
8	>	CONTAINS	INCLUDE	DTID(300) Measurement	1-n	U		\$Measurement= EV(G-0366, SRT, "Vessel Lumen Cross-Sectional Area") \$Derivation=DCID(3838) Diameter Derivation \$FindingSite=DCID(3486) IVUS Measurement Sites \$Units=DT(mm2, UCUM, "mm^2")
9	>	CONTAINS	CODE	EV(G-C504, SRT, "Associated Morphology")	1-n	M		DCID(3810) Vascular Morphology
10	>>		INCLUDE	DTID(3909) Best Illustration of Findings	1-n	U		
11	>>	HAS PROPERTIES	TEXT	EV(121106, DCM, "Comment")	1-n	U		
12	>>		INCLUDE	DTID(3911) Plaque Properties	1	MC	IFF value of row 9 equals (M-01470, SRT, "Plaque")	
13	>>		INCLUDE	DTID(3912) Stenosis Properties	1	MC	IFF value of row 9 equals (M-34200, "Stenosis")	
14	>>		INCLUDE	DTID(3913) Aneurysm Properties	1	MC	IFF value of row 9 equals (M-32200, SRT, "Aneurysm")	
15	>>		INCLUDE	DTID(3914) Dissection Properties	1	MC	IFF value of row 9 equals (D3-81310, SRT, "Arterial Dissection")	
16	>>	HAS PROPERTIES	CODE	EV(G-C504, SRT, "Associated Morphology")	1	MC	IFF value of row 9 equals (M-520F8, SRT, "Vascular Sclerosis")	DCID(3817) Vascular Sclerosis Types
17	>>		INCLUDE	DTID(3915) Vascular Occlusion Properties	1	MC	IFF value of row 9 equals EVM-34000, SRT, "Occlusion")	
18	>>		INCLUDE	DTID(3916) Stent Properties	1	MC	IFF value of row 9 equals (A-25500, SRT, "Stent")	

### Content Item Descriptions

Row	Description
Row 5	A positive value indicates a distance in the direction of flow within the vessel For example: An aneurysm with relative position -4 mm from the renal arteries would begin superior to the renal arteries.
Row 7, 8	These rows are associated with the position of the most significant effect of the lesion, i.e. maximum diameter of aneurysm or the minimum diameter of stenosis

**TID 3909 Best Illustration of Findings**

Specification of images, waveforms, spatial and temporal coordinates used to illustrate findings.

**TID 3909  
Best Illustration of Findings  
Type: Extensible**

NL	Rel with Parent	VT	Concept Name	VM	Req Type	Condition	Value Set Constraint
1	CONTAINS	IMAGE	EV (121080, DCM, "Best illustration of finding")	1	U		
2	CONTAINS	WAVEFORM	EV (121080, DCM, "Best illustration of finding")	1	U		
3	CONTAINS	SCOORD	EV (121080, DCM, "Best illustration of finding")	1	U		
4	> SELECTED FROM	IMAGE	no purpose of reference	1	M		
5	CONTAINS	TCOORD	EV (121080, DCM, "Best illustration of finding")	1	U		
6	> SELECTED FROM	SCOORD	no purpose of reference	1	MC	XOR row 8, 9	
7	>> SELECTED FROM	IMAGE	no purpose of reference	1	MC		must be a multiframe image
8	> SELECTED FROM	WAVEFORM	no purpose of reference	1	MC	XOR row 6, 9	
9	> SELECTED FROM	IMAGE	no purpose of reference	1	MC	XOR row 6, 8	must be a multiframe image

**TID 3910 Flow Quantification**

Contains the flow quantification measurement results

**TID 3910  
Flow Quantification  
Type: Extensible**

NL	Rel with Parent	VT	Concept Name	VM	Req Type	Condition	Value Set Constraint
1	CONTAINS	CONTAINER	EV (121070, DCM, "Findings")	1	M		
2	> HAS CONCEPT MOD	CODE	EV(111004, DCM, "Analysis Performed")	1	M		EV (122604, DCM, "Flow Quantification")
3	> HAS OBS CONTEXT	INCLUDE	DTID(3929) Cardiovascular Analysis Observation Context	1	U		
4	> HAS OBS CONTEXT	DATETIME	EV(G-D321, SRT, "Start Time")	1	M		
5	> HAS OBS CONTEXT	DATETIME	EV(G-D320, SRT, "Stop Time")	1	M		
6	> CONTAINS	INCLUDE	DTID(3990) 2-Dimensional Measurement Graph	1	U		\$MeasurementGraph = EV(122667, DCM, "Blood velocity vs. time of cardiac cycle") \$X-Concept = EV(122666, DCM, "Time relative to R-wave peak") \$Y-Concept = EV(F-0319E, SRT, "Arterial Velocity") \$X-AxisUnits= DT(ms, UCUM, "ms") \$Y-AxisUnits= DT(cm/s, UCUM, "cm/s")
7	> CONTAINS	NUM	EV(122642, DCM, "Velocity Encoding Minimum Value")	1	U		Units = DT(cm/s, UCUM, "cm/s")
8	> CONTAINS	NUM	EV(122643, DCM, "Velocity Encoding Maximum Value")	1	U		Units = DT(cm/s, UCUM, "cm/s")

NL	Rel with Parent	VT	Concept Name	VM	Req Type	Condition	Value Set Constraint
			"Velocity Encoding Maximum Value")				
9	>	CONTAINS	CONTAINER	EV(125007, DCM, "Measurement Group")	1-n	M	
10	>>	HAS CONCEPT MOD	TEXT	EV(G-C0E3, SRT, "Finding Site")	1	MC	XOR row 11
11	>>	HAS CONCEPT MOD	CODE	EV(G-C0E3, SRT, "Finding Site")	1	MC	XOR row 10
12	>>	CONTAINS	INCLUDE	DTID(300) Measurement	1	U	\$Measurement = EV(122207, DCM, "Blood Velocity, Peak") \$Units = DT(cm/s, UCUM, "cm/s")
13	>>	CONTAINS	INCLUDE	DTID(300) Measurement	1	U	\$Measurement = EV(122205, DCM, "Blood Velocity, Mean") \$Units = DT(cm/s, UCUM, "cm/s")
14	>>	CONTAINS	INCLUDE	DTID(300) Measurement	1	U	\$Measurement = EV(F-39200, SRT, "Blood Flow") \$Derivation = EV(R-00317, SRT, "Mean") \$Units = DT(ml/s, UCUM, "ml/s")
15	>>	CONTAINS	INCLUDE	DTID(300) Measurement	1-2	U	\$Measurement = EV(F-39200, SRT, "Blood Flow") \$ModType = EV(G-C048, SRT, "Direction of flow") \$ModValue = DCID(12221) Flow Direction \$Units = DT(ml/s, UCUM, "ml/s")
16	>>	CONTAINS	INCLUDE	DTID(300) Measurement	1	U	\$Measurement = EV(122645, DCM, "Net Forward Volume") \$Units = DT(ml, UCUM, "ml")
17	>>	CONTAINS	INCLUDE	DTID(300) Measurement	1	U	\$Measurement = EV(122645, DCM, "Net Forward Volume") \$ModType=EV(121425, DCM, "Index") \$ModValue= DT(8277-6, LN, "BSA") \$Units = (ml/m <sup>2</sup> , UCUM, "ml/m <sup>2</sup> ")
18	>>	CONTAINS	INCLUDE	DTID(300) Measurement	1-n	U	\$Measurement = EV(G-0366, SRT, "Vessel Lumen Cross-Sectional Area") \$Derivation = DCID (3488) Min/Max/Mean \$Units = DT(mm <sup>2</sup> , UCUM, "mm <sup>2</sup> ")
19	>>	CONTAINS	INCLUDE	DTID(300) Measurement	1	U	\$Measurement = EV(F-32110, SRT, "Cardiac Index") \$Units = DT(l/min/m <sup>2</sup> , UCUM, "l/min/m <sup>2</sup> ")

**TID 3911 Plaque Properties**  
Properties of a plaque finding

**TID 3911**  
**Plaque Properties**  
**Type: Extensible**

NL	Rel with Parent	VT	Concept Name	VM	Req Type	Condition	Value Set Constraint
1	HAS PROPERTIES	NUM	EV(122376, DCM, "Total Plaque Volume")	1	U		Units=DT(mm <sup>3</sup> ,UCUM,"mm <sup>3</sup> ")
2	HAS PROPERTIES	CODE	EV(G-A428, SRT, "Margin")	1	U		DCID(3715) Lesion Morphology
3	HAS PROPERTIES	CODE	EV(M-01000, SRT, "Morphological Abnormal Structure")	1-n	M		DCID(3802) Plaque Structures
4	HAS PROPERTIES	INCLUDE	DTID (3905) Calcium Scoring Results	1	U		
5	HAS PROPERTIES	CODE	EV(121071, DCM, "Contrast Media Seen in Plaque")	1	U		DT(R-102DA, SRT, "Contrast Media Seen in Plaque")

NL	Rel with Parent	VT	Concept Name	VM	Req Type	Condition	Value Set Constraint
	PROPERTIES		"Finding")				Plaque")

**TID 3912 Stenosis Properties**

Properties of a stenosis finding

**TID 3912  
Stenosis Properties  
Type: Extensible**

NL	Rel with Parent	VT	Concept Name	VM	Req Type	Condition	Value Set Constraint
1	HAS PROPERTIES	CODE	EV(G-C036, SRT, "Measurement method")	1	M		DCID(3804) Stenosis Measurement Methods
2	HAS PROPERTIES	CODE	EV(G-D775, SRT, "Type of Stenosis")	1	U		DCID(3805) Stenosis Types
3	HAS PROPERTIES	CODE	EV(G-C002, SRT, "Associated with")	1	U		DCID(3815) Source of Vascular Finding
4	HAS PROPERTIES	CODE	EV(G-C2FE, SRT, "Shape")	1	U		DCID(3806) Stenosis Shapes
5	HAS PROPERTIES	INCLUDE	DTID(300) Measurement	1-n	U		\$Measurement= EV(G-0364, SRT, "Vessel Lumen Diameter") \$Derivation= DCID(3488) Min/Max/Mean \$Units=DT(mm, UCUM, "mm")
6	HAS PROPERTIES	INCLUDE	DTID(300) Measurement	1-n	U		\$Measurement= EV(G-0366, SRT, "Vessel Lumen Cross-Sectional Area") \$Derivation= DCID(3488) Min/Max/Mean \$Units=DT(mm <sup>2</sup> , UCUM, "mm <sup>2</sup> ")
7	HAS PROPERTIES	NUM	EV(R-101BC, SRT, "Stenotic Lesion Length")	1	U		Units=DT(mm, UCUM, "mm")
8	HAS PROPERTIES	CODE	EV(R-101BC, SRT, "Stenotic Lesion Length")	1	U		DCID(3831) Stenosis Length
9	HAS PROPERTIES	INCLUDE	DTID(300) Measurement	1-n	U		\$Measurement= EV(R-101BA, SRT, "Lumen Area Stenosis") \$Derivation= DCID(3488) Min/Max/Mean \$Units=DT(%, UCUM, "%")
10	HAS PROPERTIES	INCLUDE	DTID(300) Measurement	1-n	U		\$Measurement= EV(R-101BB, SRT, "Lumen Diameter stenosis") \$Derivation= DCID(3488) Min/Max/Mean \$Units=DT(%, UCUM, "%")
11	HAS PROPERTIES	CODE	EV(R-101BA, SRT, "Lumen Area Stenosis")	1-n	U		DCID(3832) Stenosis Grade
12>	HAS CONCEPT MOD	CODE	EV(121401, DCM, "Derivation")	1	M		DCID(3488) Min/Max/Mean

**TID 3913 Aneurysm Properties**

Properties of an aneurysm finding

**TID 3913  
Aneurysm Properties  
Type: Extensible**

NL	Rel with Parent	VT	Concept Name	VM	Req Type	Condition	Value Set Constraint
1	HAS PROPERTIES	CODE	EV(G-C504, SRT, "Aneurysm Type")	1-n	M		DCID (3808) Aneurysm Types

NL	Rel with Parent	VT	Concept Name	VM	Req Type	Condition	Value Set Constraint
	PROPERTIES		"Associated Morphology")				
2	HAS PROPERTIES	CODE	EV(G-C002, SRT, "Associated with")	1	U		DCID(3815) Source of Vascular Finding
3	HAS PROPERTIES	INCLUDE	DTID(3917) Aneurysm Measurements	1	U		
4	HAS PROPERTIES	CODE	EV(G-C504, SRT, "Associated Morphology")	1-n	UC	IFF value of row 1 equals (M-32206, SRT, "Compound Aneurysm")	DCID (3808) Aneurysm Types
5	> HAS PROPERTIES	INCLUDE	DTID(3917) Aneurysm Measurements	1	U		

**TID 3914 Arterial Dissection Properties**

Properties of a arterial dissection finding

**TID 3914**  
**Arterial Dissection Properties**  
**Type: Extensible**

NL	Rel with Parent	VT	Concept Name	VM	Req Type	Condition	Value Set Constraint
1	HAS PROPERTIES	CODE	EV(122387, DCM, "Dissection Classification")	1	M		DCID(3492) IVUS Dissection Classification
2	HAS PROPERTIES	CODE	EV(G-C150, SRT, "Etiology")	1	U		DCID(3809) Associated Conditions
3	HAS PROPERTIES	NUM	EV(G-A22A, SRT, "Length")	1	U		Units= DT(mm, UCUM, "mm")
4	HAS PROPERTIES	CODE	EV(R-102DD, SRT, "Anatomic structure potentially involved in evolution of disease")	1-n	U		DCID(3827) Vessel Segments

**TID 3915 Vascular Occlusion Properties**

Properties of vascular occlusion finding

**TID 3915**  
**Vascular Occlusion Properties**  
**Type: Extensible**

NL	Rel with Parent	VT	Concept Name	VM	Req Type	Condition	Value Set Constraint
1	HAS PROPERTIES	CODE	EV(G-D775, SRT, "Type of Stenosis")	1	M		DCID(3805) Stenosis Types
2	HAS PROPERTIES	CODE	EV(G-C002, SRT, "Associated with")	1	U		DCID(3815) Source of Vascular Finding
3	HAS PROPERTIES	CODE	EV(G-C2FE, SRT, "Shape")	1	U		DCID(3806) Stenosis Shapes
4	HAS PROPERTIES	INCLUDE	DTID(300) Measurement	1	U		\$Measurement=EV(R-101BC, SRT, "Stenotic Lesion Length") \$Method= DCID(3804) Stenosis Measurement Methods \$Units=DT(mm, UCUM, "mm")

**TID 3916 Stent Properties**

Properties of a stent finding

**TID 3916  
Stent Properties  
Type: Extensible**

NL	Rel with Parent	VT	Concept Name	VM	Req Type	Condition	Value Set Constraint
1	HAS PROPERTIES	CODE	EV(155, DCM, "Stent Composition")	1-n	M		DCID(38014) Stent Composition
2	HAS PROPERTIES	NUM	EV(R-101AD, SRT, "Vascular Stent Diameter")	1	U		Units= DT(mm, UCUM, "mm")
3	HAS PROPERTIES	NUM	EV(R-101B0, SRT, "Vascular Stent Length")	1	U		Units= DT(mm, UCUM, "mm")
4	HAS PROPERTIES	CODE	EV(121071, DCM, "Finding")	1-n	U		DCID(3813) Stent Findings
5	>	INCLUDE	DTID(3912) Stenosis Properties	1	MC	IFF value of row 4 equals (M-34200, SRT, "Stenosis")	

**TID 3917 Aneurysm Measurements**

Measurements of aneurysms. TID 300 invoked from this template allows the measurement to reference an image used as the source of the measurement.

**TID 3917  
Aneurysm Measurements  
Type: Extensible**

NL	Rel with Parent	VT	Concept Name	VM	Req Type	Condition	Value Set Constraint
1		INCLUDE	DTID(300) Measurement	1	U		\$Measurement= EV(G-A22A, SRT, "Length") \$ModType = EV(G-C093, SRT, "Extent") \$ModValue = DT(G-A143, SRT, "Longitudinal") \$Units=DT(mm, UCUM, "mm")
2		INCLUDE	DTID(300) Measurement	1	U		\$Measurement= EV(G-D705, SRT, "Volume") \$Method= DCID(3807) Volume Measurement Methods \$Units=DT(mm3, UCUM, "mm^3")
3		INCLUDE	DTID(300) Measurement	1	U		\$Measurement= EV(R-102DB, SRT, "Vessel Lumen Cross-Sectional Area Increase") \$Units=DT(%, UCUM, "%")
4		INCLUDE	DTID(300) Measurement	1	U		\$Measurement= EV(R-102DB, SRT, "Vessel Lumen Cross-Sectional Area Increase") \$Units=DT(mm2, UCUM, "mm^2")
5		INCLUDE	DTID(300) Measurement	1	U		\$Measurement= EV(R-102DC, SRT, "Vessel Lumen Cross-Sectional Diameter Increase") \$Units=DT(%, UCUM, "%")
6		INCLUDE	DTID(300) Measurement	1	U		\$Measurement= EV(R-102DC, SRT, "Vessel Lumen Cross-Sectional Diameter Increase") \$Units=DT(mm, UCUM, "mm")

**TID 3920 Ventricular Analysis**

Contains the ventricular functional measurement results.

**TID 3920**  
**Ventricular Analysis**  
**Type: Extensible**

	NL	Rel with Parent	VT	Concept Name	VM	Req Type	Condition	Value Set Constraint
1			CONTAINER	EV (121070, DCM, "Findings")	1	M		
2	>	HAS CONCEPT MOD	CODE	EV(111004, DCM, "Analysis Performed")	1	M		EV(122601, DCM, "Ventricular Analysis")
3	>	HAS OBS CONTEXT	INCLUDE	DTID (3929) Cardiovascular Analysis Observation Context	1	U		
4	>	CONTAINS	INCLUDE	DTID (3921) Ventricular Measurements	1-n	U		\$Ventricle = EV (T-32600, SRT, "Left Ventricle")
5	>	CONTAINS	INCLUDE	DTID (3921) Ventricular Measurements	1-n	U		\$Ventricle = EV (T-32500, SRT, "Right Ventricle")
6	>	CONTAINS	INCLUDE	DTID (3925) Thickening Analysis	1-n	U		
7	>	CONTAINS	INCLUDE	DTID (3926) Myocardial Perfusion Analysis	1-n	U		

**TID 3921 Ventricular Measurements**

Ventricular measurement results related to the volume of a ventricle.

Parameter Name	Parameter Usage
\$Ventricle	Describes if either the left or the right ventricle was examined

**TID 3921**  
**Ventricular Measurements**  
**Type: Extensible**

	NL	Rel with Parent	VT	Concept Name	VM	Req Type	Condition	Value Set Constraint
1		CONTAINS	CONTAINER	EV (121070, DCM, "Findings")	1	M		
2	>	HAS CONCEPT MOD	CODE	EV(G-C0E3, SRT, "Finding Site")	1	M		\$Ventricle
3	>	CONTAINS	INCLUDE	DTID(3922) Absolute Values Of Ventricular Measurements	1	M		
4	>	CONTAINS	INCLUDE	DTID(3923) BSA-Normalized Ventricular Measurements	1	U		
5	>	CONTAINS	INCLUDE	DTID(3924) Heart Rate-Normalized Ventricular Measurements	1	U		



**TID 3922 Absolute Values Of Ventricular Measurements**

Ventricular measurement results related to the absolute volume of a ventricle.

**TID 3922  
Absolute Values Of Ventricular Measurements  
Type: Extensible**

NL	Rel with Parent	VT	Concept Name	VM	Req Type	Condition	Value Set Constraint
1	CONTAINS	CONTAINER	EV(122608, DCM, "Absolute Values Of Ventricular Measurements")	1	M		
2	>	CONTAINS	INCLUDE	DTID(300) Measurement	1-n	U	\$Measurement = DCID(3833) Cardiac Ejection Fraction \$ModType = DT(122670, DCM, "Papillary Muscle Included/Excluded") \$ModValue = DCID(3821) Papillary Muscle Included/Excluded \$Method = DCID(3807) Volume Measurement Methods \$Units = DT(%, UCUM, "%")
3	>	CONTAINS	INCLUDE	DTID(300) Measurement	1-n	U	\$Measurement = DCID(3835) Volume Measurements \$ModType = DT(122670, DCM, "Papillary Muscle Included/Excluded") \$ModValue = DCID(3821) Papillary Muscle Included/Excluded \$Units = DT(ml, UCUM, "ml")
4	>	CONTAINS	INCLUDE	DTID(300) Measurement	1	U	\$Measurement = EV(F-32100, SRT, "Cardiac Output") \$ModType = DT(122670, DCM, "Papillary Muscle Included/Excluded") \$ModValue = DCID(3821) Papillary Muscle Included/Excluded \$Units = DT(l/min, UCUM, "l/min")
5	>	CONTAINS	INCLUDE	DTID(300) Measurement	1-n	U	\$Measurement = EV(122447, DCM, "Wall Mass") \$ModType = DT(122670, DCM, "Papillary Muscle Included/Excluded") \$ModValue = DCID(3821) Papillary Muscle Included/Excluded \$Units = DT(g, UCUM, "g")
6	>>	HAS CONCEPT MOD	CODE	EV(R-4089A, SRT, "Cardiac Cycle Point")	1	U	DCID(12233) Cardiac Cycle Point
7	>	CONTAINS	INCLUDE	DTID(300) Measurement	1	U	\$Measurement = EV(122616, DCM, "Peak Ejection Rate") \$Units = DT(ml/s, UCUM, "ml/s")
8	>	CONTAINS	NUM	EV(122617, DCM, "Peak Ejection Time")	1	U	Units = EV(s, UCUM, "s")
9	>>	HAS CONCEPT MOD	CODE	EV(122611, DCM, "Reference Point")	1	M	EV(F-32011, SRT, "End-Diastolic")
10	>	CONTAINS	INCLUDE	DTID(300) Measurement	1	U	\$Measurement = EV(122618, DCM, "Peak Filling Rate") \$Units = DT(ml/s, UCUM, "ml/s")
11	>	CONTAINS	NUM	EV(122619, DCM, "Peak Filling Time")	1	U	\$Units = DT(s, UCUM, "s")
12	>>	HAS CONCEPT MOD	CODE	EV(122611, DCM, "Reference Point")	1	M	DT(109070, DCM, "End-Systolic")

**TID 3923 BSA-Normalized Ventricular Measurements**

Ventricular measurement results normalized based on the Body Surface Area

**TID 3923**  
**BSA-normalized Ventricular Measurements**  
**Type: Extensible**

NL	Rel with Parent	VT	Concept Name	VM	Req Type	Condition	Value Set Constraint
1	CONTAINS	CONTAINER	EV(122609, DCM, "Normalized values of ventricular measurements")	1	M		
2	> HAS CONCEPT MOD	CODE	EV(121425, DCM, "Index")	1	M		DT(8277-6, LN, "Body Surface Area")
3	> CONTAINS	INCLUDE	DTID(300) Measurement	1-n	U		\$Measurement = DCID(3835) Volume Measurements \$ModType = EV (121425, DCM, "Index") \$ModValue = DT(8277-6, LN, "Body Surface Area") \$Units=DT(ml/m2, UCUM, "ml/m^2")
4	> CONTAINS	INCLUDE	DTID(300) Measurement	1	U		\$Measurement = EV(F-32110, SRT, "Cardiac Index") \$Units=DT(ml/min/m2, UCUM, "(ml/min)/m^2")
5	> CONTAINS	INCLUDE	DTID(300) Measurement	1-2	U		\$Measurement = EV(122447, DCM, "Wall Mass") \$ModType = EV (121425, DCM, "Index") \$ModValue = DT(8277-6, LN, "Body Surface Area") \$Units=DT(g/m2, UCUM, "g/m^2")
6	>> HAS CONCEPT MOD	CODE	DT(122670, DCM, "Papillary Muscle Included/Excluded")	1	U		DCID(3821) Papillary Muscle Included/Excluded
7	> CONTAINS	INCLUDE	DTID(300) Measurement	1	U		\$Measurement = EV(122618, DCM, "Peak Filling Rate") \$ModType = EV (121425, DCM, "Index") \$ModValue = DT(8277-6, LN, "Body Surface Area") \$Units=DT(ml/s/m2, UCUM, "(ml/s)/m^2")
8	> CONTAINS	INCLUDE	DTID(300) Measurement	1	U		\$Measurement = EV(F-32070, SRT, "Peak Cardiac Ejection Fraction") \$ModType = EV (121425, DCM, "Index") \$ModValue = DT(8277-6, LN, "Body Surface Area") \$Units=DT(%/m2, UCUM, "%/m^2")

**TID 3924 Heart Rate-Normalized Ventricular Measurements**

Ventricular measurement results normalized based on the Heart Rate

**TID 3924**  
**Heart Rate-Normalized Ventricular Measurements**  
**Type: Extensible**

NL	Rel with Parent	VT	Concept Name	VM	Req Type	Condition	Value Set Constraint
1	CONTAINS	CONTAINER	EV(122609, DCM, "Normalized values of ventricular measurements")	1	M		
2	> HAS CONCEPT MOD	CODE	EV(121425, DCM, "Index")	1	M		DT(8867-4, LN, "Heart Rate")

NL	Rel with Parent	VT	Concept Name	VM	Req Type	Condition	Value Set Constraint	
3	>	CONTAINS	INCLUDE	DTID(300) Measurement	1-n	U		\$Measurement = DCID(3835) Volume Measurements \$ModType = EV (121425, DCM, "Index") \$ModValue = DT(8867-4, LN, "Heart Rate") \$Units=DT(ml/{H.B.}/min, UCUM, "ml/BPM")
4	>	CONTAINS	INCLUDE	DTID(300) Measurement	1	U		\$Measurement = EV(F-32100, SRT, "Cardiac Output") \$ModType = EV (121425, DCM, "Index") \$ModValue = DT(8867-4, LN, "Heart Rate") \$Units = DT(ml/min/{H.B.}/min, UCUM, "(ml/min)/ BPM")
5	>	CONTAINS	INCLUDE	DTID(300) Measurement	1	U		\$Measurement = EV(122618, DCM, "Peak Filling Rate") \$ModType = EV (121425, DCM, "Index") \$ModValue = DT(8867-4, LN, "Heart Rate") \$Units = DT(ml/s/{H.B.}/min, UCUM, "(ml/s)/BPM")
6	>	CONTAINS	INCLUDE	DTID(300) Measurement	1	U		\$Measurement = EV(F-32070, SRT, "Peak Cardiac Ejection Fraction") \$ModType = EV (121425, DCM, "Index") \$ModValue = DT(8867-4, LN, "Heart Rate") \$Units=DT(%/{H.B.}/min, UCUM, "%/BPM")

**TID 3925 Ventricular Thickening Analysis**

Data of a ventricular wall thickening analysis

**TID 3925  
Thickening Analysis  
Type: Extensible**

NL	Rel with Parent	VT	Concept Name	VM	Req Type	Condition	Value Set Constraint	
1		CONTAINS	CONTAINER	EV (121070, DCM, "Findings")	1	M		
2	>	HAS CONCEPT MOD	CODE	EV(111004, DCM, "Analysis Performed")	1	M		EV (122607, DCM, "Thickening Analysis")
3	>	CONTAINS	CONTAINER	EV (121070, DCM, "Findings")	1-n	M		
4	>>	CONTAINS	CODE	EV(G-C0E3, SRT, "Finding Site")	1-n	MC	XOR row 5	DCID(3717) Myocardial Wall Segments
5	>>	CONTAINS	TEXT	EV(G-C0E3, SRT, "Finding Site")	1	MC	XOR row 4	
6	>>	CONTAINS	INCLUDE	DTID(3909) Best Illustration of Findings	1-n	U		
7	>>	CONTAINS	INCLUDE	DTID(300) Measurement	1	M		\$Measurement = EV(122445, DCM, "Wall Thickness") \$ModType= EV(R-4089A, SRT, "Cardiac Cycle Point") \$ModValue= DT(F-32011, SRT, "End-Diastolic") \$Units = DT(mm, UCUM, "mm")
8	>>	CONTAINS	INCLUDE	DTID(300) Measurement	1	M		\$Measurement = EV(122445, DCM, "Wall Thickness") \$ModType= EV(R-4089A, SRT, "Cardiac Cycle Point") \$ModValue= DT(109070, DCM, "End-Systolic") \$Units = DT(mm, UCUM, "mm")
9	>>	CONTAINS	INCLUDE	DTID(300) Measurement	1	U		\$Measurement = EV(122624, DCM, "Wall Thickness Ratio end-systolic to end-

NL	Rel with Parent	VT	Concept Name	VM	Req Type	Condition	Value Set Constraint
							diastolic") \$Units = DT(% , UCUM, "%")
10 >>	CONTAINS	CODE	EV(F-32050, SRT, "Cardiac Wall Motion")	1	U		DCID (3703) Wall Motion
11 >>	CONTAINS	CODE	EV(G-C504, SRT, "Associated Morphology")	1	U		DCID (3704) Wall Morphology Findings

**TID 3926 Myocardial Perfusion Analysis**

Myocardial perfusion analysis results.

Perfusion measurements may be performed either for one or more ventricular segments (row 4) or for substructures inside ventricular segments (row 14)

**TID 3926  
Myocardial Perfusion Analysis  
Type: Extensible**

NL	Rel with Parent	VT	Concept Name	VM	Req Type	Condition	Value Set Constraint
1	CONTAINS	CONTAINER	EV (121070, DCM, "Findings")	1	M		
2 >	HAS CONCEPT MOD	CODE	EV(111004, DCM, "Analysis Performed")	1	M		EV(122602, DCM, "Myocardial Perfusion Analysis")
3 >	CONTAINS	CONTAINER	EV (121070, DCM, "Findings")	1-n	M		
4 >>	HAS CONCEPT MOD	CODE	EV(G-C0E3, SRT, "Finding Site")	1-n	MC	XOR row 6	DCID(3717) Myocardial Wall Segments
5 >>>	HAS CONCEPT MOD	CODE	EV(G-A1F8, SRT, "Topographical Modifier")	1	U		DCID(3843) Myocardial Subsegment
6 >>	HAS CONCEPT MOD	TEXT	EV(G-C0E3, SRT, "Finding Site")	1	MC	XOR row 4	
7 >>	HAS ACQ CONTEXT	CODE	EV(109054, DCM, "Patient State")	1	U		DCID(3101) NM Procedural State Values
8 >>	HAS ACQ CONTEXT	INCLUDE	DTID (3106) Drugs/Contrast Administered	1-n	U		
9 >>	CONTAINS	TEXT	EV(122627, DCM, "Curve Fit Method")	1	U		
10 >>	CONTAINS	INCLUDE	DTID(3909) Best Illustration of Findings	1-n	U		
11 >>	CONTAINS	TEXT	EV(122628, DCM, "Baseline Result Correction")	1	U		
12 >>	CONTAINS	INCLUDE	DTID(300) Measurement	1-n	U		\$Measurement = DCID(3836) Time-based Perfusion Measurements \$Units= EV(s, UCUM, "s")
13 >>	CONTAINS	NUM	EV(122640, DCM, "Image Interval")	1	U		Units= EV(ms, UCUM, "ms")
14 >>	CONTAINS	NUM	EV(122635, DCM, "MR Perfusion Peak")	1	U		Units=DT(1, UCUM, "No units")
15 >>	CONTAINS	NUM	EV(122636, DCM, "MR Perfusion Slope")	1	U		Units=DT(1, UCUM, "No units")
16 >>	CONTAINS	NUM	EV(122637, DCM, "MR Perfusion Time Integral")	1	U		Units=DT(1, UCUM, "No units")
17 >>	CONTAINS	CONTAINER	EV(125007, DCM, "Measurement Group")	1-n	U		

	NL	Rel with Parent	VT	Concept Name	VM	Req Type	Condition	Value Set Constraint
18	>>>	CONTAINS	INCLUDE	DTID(300) Measurement	1-n	U		\$Measurement = DCID(3836) Time-based Perfusion Measurements \$Units= EV(s, UCUM, "s")
19	>>>	CONTAINS	NUM	EV(122635, DCM, "MR Perfusion Peak")	1	U		Units=DT(1, UCUM, "No units")
20	>>>	CONTAINS	NUM	EV(122636, DCM, "MR Perfusion Slope")	1	U		Units=DT(1, UCUM, "No units")
21	>>>	CONTAINS	NUM	EV(122637, DCM, "MR Perfusion Time Integral")	1	U		Units=DT(1, UCUM, "No units")
22	>>	CONTAINS	CODE	EV(122664, DCM, "Late Contrast Enhancement")	1	U		DCID(230) Yes-No
23	>>>	HAS ACQ CONTEXT	NUM	EV(122665, DCM, "Time after start of injection of contrast bolus")	1	M		Units=DT(s, UCUM, "s")
24	>>>	HAS ACQ CONTEXT	NUM	EV(122668, DCM, "Time interval since detection of contrast bolus")	1	U		Units=DT(s, UCUM, "s")

**Content Item Descriptions**

Row 12	Image Interval is appropriate only for equally time-spaced images
--------	---

**TID 3927 Report Summary**

Contains summary elements based on the findings of the report

**TID 3927  
Report Summary  
Type: Extensible**

	NL	Rel with Parent	VT	Concept Name	VM	Req Type	Condition	Value Set Constraint
1			CONTAINER	BCID(7001) Diagnostic Imaging Reports Headings	1	M		
2	>	CONTAINS	CODE	BCID(7002) Diagnostic Imaging Report Elements	1-n	U		
3	>>		INCLUDE	DTID(320) Image or Spatial Coordinates	1-n	U		
4	>>		INCLUDE	DTID(321) Waveform or Temporal Coordinates	1-n	U		
5	>	CONTAINS	TEXT	BCID(7002) Diagnostic Imaging Report Elements	1-n	U		
6	>>		INCLUDE	DTID(320) Image or Spatial Coordinates	1-n	U		
7	>>		INCLUDE	DTID(321) Waveform or Temporal Coordinates	1-n	U		

**TID 3929 Cardiovascular Analysis Observation Context**

Defines the observation context for cardioVascular Functional Analysis

**TID 3929  
Cardiovascular Analysis Observation Context  
Type: Extensible**

NL	Rel with Parent	VT	Concept Name	VM	Req Type	Condition	Value Set Constraint
1	HAS OBS CONTEXT	NUM	EV(8867-4, LN, "Heart Rate")	1	U		Units= DT ("{H.B.}/min", UCUM, "BPM")
2	HAS OBS CONTEXT	CODE	EV(8884-9, LN, "Cardiac Rhythm")	1	U		DCID(3826) Heart Rhythm
3	HAS OBS CONTEXT	NUM	EV(F-008EC, SRT, "Systolic Blood Pressure")	1	U		Units=DT(mm[Hg], UCUM, "mmHg")
4	HAS OBS CONTEXT	NUM	EV(F-008ED, SRT, "Diastolic Blood Pressure")	1	U		Units=DT(mm[Hg], UCUM, "mmHg")
5	HAS OBS CONTEXT	CODE	EV (F-043E6, SRT, "Respiration Observable")	1	U		DCID(3823) Respiratory Status
6	HAS ACQ CONTEXT	INCLUDE	DTID (3106) Drugs/Contrast Administered	1-n	U		

### TID 3990 2-Dimensional Measurement Graph

Generic template representing arbitrary two-dimensional graphs.

Parameter Name	Parameter Usage
\$MeasurementGraph	Describes what the graph is about
\$X-Concept	Concept of the X-Axis of the graph
\$Y-Concept	Concept of the Y-Axis of the graph
\$X-AxisUnit	Unit of the x-axis data elements
\$Y-AxisUnit	Unit of the y-axis data elements

### TID 3990 2-Dimensional Measurement Graph Type: Extensible

NL	Rel with Parent	VT	Concept Name	VM	Req Type	Condition	Value Set Constraint
1		CONTAINER	\$MeasurementGraph	1	M		
2	>	CONTAINS	CODE	EV(122698, DCM, "X-Concept")	1	M	\$X-Concept
3	>	CONTAINS	CODE	EV(122699, DCM, "Y-Concept")	1	M	\$Y-Concept
4	>	CONTAINS	CONTAINER	no concept name	0-n	M	
5	>>	CONTAINS	NUM	\$X-Concept	1	M	UNITS= \$X-AxisUnit
6	>>	CONTAINS	NUM	\$Y-Concept	1	M	UNITS= \$Y-AxisUnit
7	>	CONTAINS	IMAGE	\$MeasurementGraph	1	U	
8	>	CONTAINS	WAVEFORM	\$MeasurementGraph	1	U	
9	>	CONTAINS	COMPOSITE	\$MeasurementGraph	1	U	

### Content Item Descriptions

Rows 5-6	The X-Concept values shall be monotonically increasing.
Row 7	Secondary Capture Image containing a bitmap representation of the graph
Row 8	Waveform containing a representation of the graph
Row 9	Composite Object containing a rendered representation of the graph

## MAMMOGRAPHY CAD SR IOD TEMPLATES

The templates that comprise the Mammography CAD SR IOD are interconnected as in Figure A-8:

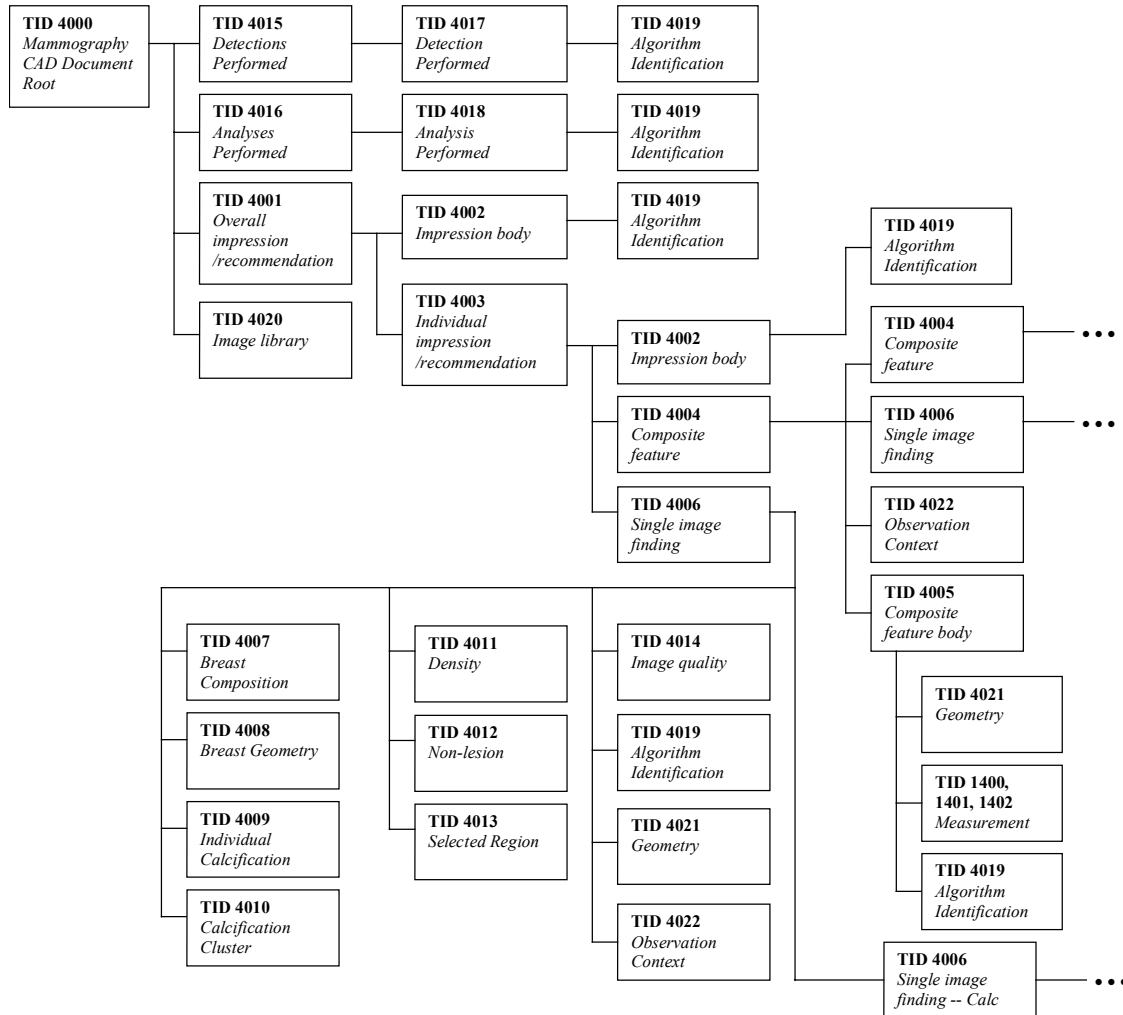

**Figure A-8: Mammography CAD SR IOD Template Structure**

In Figure A-8, '...' indicates possible recursive application of subordinate templates.

**TID 4000 Mammography CAD Document Root Template**

This template forms the top of a content tree that allows a mammography CAD device to describe the results of detection and analysis of Mammographic evidence. This template, together with its subordinate templates, describes both the results for presentation to radiologists and partial product results for consumption by mammography CAD devices in subsequent mammography CAD reports.

This template defines a Container which contains an Image Library, the mammography CAD results, and summaries of the detection and analysis algorithms performed. The Image Library contains the Image SOP Class and Instance UIDs, and selected attributes for each image referenced in either the algorithm summaries or mammography CAD results.

The Summary of Detections and Summary of Analyses sub-trees gather lists of algorithms attempted, grouped by success/failure status. Algorithms not attempted are not mentioned in these sub-trees. This information forms the basis for understanding why a mammography CAD report may produce no (or fewer than anticipated) results. Mammography CAD results are constructed bottom-up, starting from Single Image Findings (see Template 4006), associated as Composite Features (see Template 4004), and from which Individual and Overall Impressions are formed.

See the figure entitled "Top Levels of Mammography CAD SR Content Tree" in the "Mammography CAD SR Content Tree Structure" Annex of PS 3.17.

**TID 4000  
MAMMOGRAPHY CAD DOCUMENT ROOT  
Type: Non-Extensible**

NL	Rel with Parent	VT	Concept Name	VM	Req Type	Condition	Value Set Constraint
1		CONTAINER	EV(111036, DCM, "Mammography CAD Report")	1	M		
2	>	HAS CONCEPT MOD	DTID (1204) "Language of Content Item and Descendants"	1	M		
3	>	CONTAINS	CONTAINER EV(111028, DCM, "Image Library")	1	M		
4	>>	CONTAINS	INCLUDE DTID (4020) "CAD Image Library Entry"	1-n	M		\$ImageLaterality = DCID (6022) "Side", \$ImageView = DCID (4014) "View for Mammography", \$ImageViewMod = DCID (4015) "View Modifier for Mammography"
5	>	CONTAINS	INCLUDE DTID (4001) "Mammography CAD Overall Impression / Recommendation"	1	M		
6	>	CONTAINS	CODE EV(111064, DCM, "Summary of Detections")	1	M		DCID (6042) "Status of Results"
7	>>	INFERRED FROM	INCLUDE DTID (4015) "CAD Detections Performed"	1	MC	Shall be present unless the value of (111064, DCM, "Summary of Detections") is (111225, DCM, "Not Attempted")	\$DetectionCode = DCID (6014) "Mammography Single Image Finding"
8	>	CONTAINS	CODE EV(111065, DCM, "Summary of Analyses")	1	M		DCID (6042) "Status of Results"
9	>>	INFERRED FROM	INCLUDE DTID (4016) "CAD Analyses Performed"	1	MC	Shall be present unless the value of (111065, DCM, "Summary of Analyses") is (111225, DCM, "Not Attempted")	\$AnalysisCode = DCID (6043) "Types of Mammography CAD Analysis"



**Content Item Descriptions**

Image Library	The "Image Library" section of the Content Tree (TID 4000, row 3) shall include all Image SOP Instances from the Current Requested Procedure Evidence Sequence (0040,A375) attribute of the SR Document General module. If a portion of another instance of a Mammography CAD SR IOD is duplicated in the "Overall Impression/ Recommendation" section of the Content Tree, the "Image Library" shall also include all Image Library Entries referenced from the duplicated portions of the Mammography CAD SR.
Detections Performed	The "Detections Performed" and "Analyses Performed" sections of the Content Tree (TID 4000, rows 6 and 8) together shall reference all Image SOP Instances included in the Current Requested Procedure Evidence Sequence (0040,A375) attribute of the SR Document General module.
Analyses Performed	

**TID 4001 Mammography CAD Overall Impression/Recommendation Template**

This template forms the top of the mammography CAD results sub-tree. The contents of this template describe the overall impression the mammography CAD device had for the mammographic evidence presented and any recommendations that the mammography CAD device made. The details of the overall impression and recommendation are expressed in this instance of the Mammography CAD Impression/Recommendation Body (see TID 4002). The data from which the details are inferred, are expressed in the Mammography CAD Individual Impression/Recommendations (see TID 4003), of which there may be several.

**TID 4001  
MAMMOGRAPHY CAD OVERALL IMPRESSION/RECOMMENDATION  
Type: Non-Extensible**

NL	Rel with Parent	VT	Concept Name	VM	Req Type	Condition	Value Set Constraint
1		CODE	(111017, DCM, "CAD Processing and Findings Summary")	1	M		DCID (6047) "CAD Processing and Findings Summary"
2	> HAS PROPERTIES	INCLUDE	DTID (4002) "Mammography CAD Impression/Recommendation Body"	1	U		
3	> INFERRED FROM	INCLUDE	DTID (4003) "Mammography CAD Individual Impression/Recommendation"	1-n	MC	Shall be present if 1 or more (111059, DCM, "Single Image Finding") or (111015, DCM, "Composite Feature") content items are reported.	

**Content Item Descriptions**

CAD Processing and Findings Summary	<p>This code value is used to express if and why the Overall Impression/Recommendation sub-tree is empty. The Summary of Detections and Summary of Analyses sub-trees of the Document Root node contain detail about which (if any) algorithms succeeded or failed.</p> <p>If the code value indicates that there were no findings, then the code value can be used to determine whether mammography CAD processing occurred successfully, without parsing the Summary of Detections and Summary of Analyses sub-trees.</p>
-------------------------------------	---

**TID 4002 Mammography CAD Impression/Recommendation Body Template**

The details of an impression and recommendation are expressed in this template. It is applied to both Mammography CAD Overall Impression/Recommendation (TID 4001) and Mammography CAD Individual Impression/Recommendation (TID 4003).

**TID 4002  
MAMMOGRAPHY CAD IMPRESSION/RECOMMENDATION BODY  
Type: Non-Extensible**

NL	Rel with Parent	VT	Concept Name	VM	Req Type	Condition	Value Set Constraint
1		CODE	(111005, DCM, "Assessment Category")	1	MC	At least one of rows 1, 2, 3, 4, 5, 6 shall be present.	DCID (6026) "Mammography Assessment"
2		CODE	(111023, DCM, "Differential Diagnosis/ Impression")	1-n	MC	At least one of rows 1, 2, 3, 4, 5, 6 shall be present.	DCID (6002) "Change Since Last Mammogram or Prior Surgery"
3		TEXT	(111033, DCM, "Impression Description")	1	MC	At least one of rows 1, 2, 3, 4, 5, 6 shall be present.	
4		CODE	(111053, DCM, "Recommended Follow-up")	1-n	MC	At least one of rows 1, 2, 3, 4, 5, 6 shall be present.	DCID (6028) "Mammography Recommended Follow-up"
5		NUM	(111055, DCM, "Recommended Follow-up Interval")	1	MC	At least one of rows 1, 2, 3, 4, 5, 6 shall be present. May be present only if (111054, DCM, "Recommended Follow-up Date") is <u>not</u> present.	UNITS = DCID (6046) "Units of Follow-up Interval"; Values = Integer ≥ 0, where 0 = immediate follow-up
6		DATE	(111054, DCM, "Recommended Follow-up Date")	1	MC	At least one of rows 1, 2, 3, 4, 5, 6 shall be present. May be present only if (111055, DCM, "Recommended Follow-up Interval") is <u>not</u> present.	Shall be later than date of exam
7		NUM	(111013, DCM, "Certainty of impression")	1	UC	May be present only if (111005, DCM, "Assessment Category"), (111023, DCM, "Differential Diagnosis/Impression") or (111033, DCM, "Impression Description") is present.	UNITS = (% , UCUM, "Percent") Values = 0 – 100
8		INCLUDE	DTID (4019) "CAD Algorithm Identification"	1-n	M		

**Content Item Descriptions**

Certainty of Impression	The certainty that the device populating the Mammography CAD SR report places on this impression, where 0 equals no certainty and 100 equals certainty.
Impression Description	Free-form text describing the overall or an individual impression

**TID 4003 Mammography CAD Individual Impression/Recommendation Template**

This template collects an individual impression the mammography CAD device had for a lesion, non-lesion object, or correlation of related objects. The details of the impression and recommendation are expressed in the Mammography CAD Impression/Recommendation Body (see TID 4002). The data from which the details are inferred are expressed in the Composite Features (see TID 4004) and/or Single Image Findings (see TID 4006) of which there may be several.

The sub-tree headed by this template is illustrated in PS 3.17 in the Annex on Mammography CAD SR Content Tree Structure.

**TID 4003  
MAMMOGRAPHY CAD INDIVIDUAL IMPRESSION/RECOMMENDATION  
Type: Non-Extensible**

NL	Rel with Parent	VT	Concept Name	VM	Req Type	Condition	Value Set Constraint
1		CONTAINER	(111034, DCM, "Individual Impression/Recommendation")	1	M		
2	> HAS CONCEPT MOD	CODE	(111056, DCM, "Rendering Intent")	1	M		DCID (6034) "Intended Use of CAD Output"
3	> CONTAINS	INCLUDE	DTID (4002) "Mammography CAD Impression / Recommendation Body"	1	U		
4	> CONTAINS	INCLUDE	DTID (4004) "Mammography CAD Composite Feature"	1-n	MC	At least one of rows 4, 5 shall be present.	
5	> CONTAINS	INCLUDE	DTID (4006) "Mammography CAD Single Image Finding"	1-n	MC	At least one of rows 4, 5 shall be present.	

**Content Item Descriptions**

Rendering Intent	This content item constrains the SCP receiving the Mammography CAD SR IOD in its use of the contents of this template and its target content items. Mammography CAD devices may opt to use data marked "Not for Presentation" or "Presentation Optional" as input to subsequent mammography CAD processing steps. Refer to PS 3.4, Annex O Structured Reporting Standard SOP Classes for SCU and SCP Behavior.
------------------	--

**TID 4004 Mammography CAD Composite Feature Template**

This template collects a composite feature for a lesion, non-lesion object, or correlation of related objects. The details of the composition are expressed in the Mammography CAD Composite Feature Body (see TID 4005). The data from which the details are inferred, are expressed in the Composite Features (see TID 4004) and/or Single Image Findings (see TID 4006), of which there may be several.

A Composite Feature shall be INFERRED FROM any combination of two or more Composite Features or Single Image Findings or mixture thereof.

**TID 4004  
MAMMOGRAPHY CAD COMPOSITE FEATURE  
Type: Non-Extensible**

NL	Rel with Parent	VT	Concept Name	VM	Req Type	Condition	Value Set Constraint
1		CODE	(111015, DCM, "Composite Feature")	1	M		DCID (6016) "Mammography Composite Feature"
2	> HAS CONCEPT MOD	CODE	(111056, DCM, "Rendering Intent")	1	M		DCID (6034) "Intended Use of CAD Output"
3	> HAS PROPERTIES	INCLUDE	DTID (4005) "Mammography CAD Composite Feature Body"	1	M		
4	> INFERRED FROM	INCLUDE	DTID (4004) "Mammography CAD Composite Feature"	1-n	MC	At least two items shall be present: two of row 4, two of row 5, or one of each.	
5	> INFERRED FROM	INCLUDE	DTID (4006) "Mammography CAD Single Image Finding"	1-n	MC	At least two items shall be present: two of row 4, two of row 5, or one of each.	
6	> HAS OBS CONTEXT	INCLUDE	DTID (4022) "CAD Observation Context"	1	MC	Shall be present only if this feature is incorporated from a different report than its parent.	

**Content Item Descriptions**

Rendering Intent	This content item constrains the SCP receiving the Mammography CAD SR IOD in its use of the contents of this template and its target content items. Mammography CAD devices may opt to use data marked "Not for Presentation" or "Presentation Optional" as input to subsequent mammography CAD processing steps. Refer to PS 3.4, Annex O Structured Reporting Standard SOP Classes for SCU and SCP Behavior.
------------------	--

**TID 4005 Mammography CAD Composite Feature Body Template**

The details of a composite feature are expressed in this template. It is applied to Mammography CAD Composite Feature (TID 4004).

**TID 4005  
MAMMOGRAPHY CAD COMPOSITE FEATURE BODY  
Type: Non-Extensible**

	NL	Rel with Parent	VT	Concept Name	VM	Req Type	Condition	Value Set Constraint
1			CODE	(111016, DCM, "Composite type")	1	M		DCID (6035) "Composite Feature Relations ". The value shall be (111155, DCM, "Target content items are related contra-laterally") if the parent content item has code value (F-01792, SRT, "Focal asymmetric breast tissue") or (F-01793, SRT, "Asymmetric breast tissue").
2			CODE	(111057, DCM, "Scope of Feature")	1	M		DCID (6036) "Scope of Feature"
3			INCLUDE	DTID (4019) "CAD Algorithm Identification"	1	M		
4			NUM	(111011, DCM, "Certainty of Feature")	1	U		UNITS = (% , UCUM, "Percent") Value = 0 – 100
5			NUM	(111047, DCM, "Probability of cancer")	1	UC	May be present only if value of parent is <u>not</u> (111102, DCM, "Non-lesion")	UNITS = (% , UCUM, "Percent") Value = 0 – 100
6			CODE	(111042, DCM, "Pathology")	1-n	U		BCID (6030) "Mammography Pathology Codes"
7			INCLUDE	DTID (1400) "Linear Measurement"	1-n	U		The by-reference relationship to the IMAGE in TID (1400) "Linear Measurement" shall be used.
8			INCLUDE	DTID (1401) "Area Measurement"	1-n	U		The by-reference relationship to the IMAGE in TID (1401) "Area Measurement" shall be used.
9			INCLUDE	DTID (1402) "Volume Measurement"	1-n	U		The by-reference relationship to the IMAGE in TID (1402) "Volume Measurement" shall be used.
10			INCLUDE	DTID (4021) "Mammography CAD Geometry"	1-n	U		
11			NUM	DCID (6037) "Mammography Quantitative Temporal Difference Type"	1-n	UC	May be present only if the value of (111016, DCM, "Composite type") is (111153, DCM, "Target content items are related temporally")	UNITS = DCID (7460) "Units of Linear Measurement", DCID (7461) "Units of Area Measurement", DCID (7462) "Units of Volume Measurement" or (1, UCUM, "no units")
12	>	R- INFERRED FROM	NUM		2	U		The referenced numeric values shall have the same Concept Name. Their UNITS shall be the same as row 11
13			CODE	(111049, DCM, "Qualitative Difference")	1-n	UC	May be present only if the value of (111016, DCM, "Composite type") is (111153, DCM, "Target content items are related	DCID (6038) "Mammography Qualitative Temporal Difference Type"

	NL	Rel with Parent	VT	Concept Name	VM	Req Type	Condition	Value Set Constraint
							temporally")	
14	>	HAS PROPERTIES	TEXT	(111021, DCM, "Description of Change")	1	U		
15	>	R-INFERRED FROM	CODE		2	M		The referenced code values shall have the same Concept Name and be from the same context group.
16			CODE	(111048, DCM, "Quadrant location")	1	U		DCID (6020) "Quadrant Location"
17			CODE	(111014, DCM, "Clockface or region")	1	U		DCID (6018) "Clockface Location or Region"
18			CODE	(111020, DCM, "Depth")	1	U		DCID (6024) "Depth"
19			CODE	(111035, DCM, "Lesion Density")	1	UC	May be present only if value of parent is (F-01791, SRT, "Mammographic breast mass") or (F-01796,SRT,"Mammography breast density")	DCID (6008) "Density Modifier"
20			CODE	(M-020F9, SNM3, "Shape")	1	UC	May be present only if value of parent is (F-01791, SRT, "Mammographic breast mass") or (F-01796,SRT,"Mammography breast density")	DCID (6004) "Mammography Characteristics of Shape"
21			CODE	(111037, DCM, "Margins")	1-n	UC	May be present only if value of parent is (F-01791, SRT, "Mammographic breast mass") or (F-01796,SRT,"Mammography breast density")	DCID (6006) "Mammography Characteristics of Margin"
22			CODE	(111009, DCM, "Calcification Type")	1-n	UC	May be present only if value of parent is (F-01775,SRT, "Calcification Cluster") or (F-01776,SRT, "Individual Calcification")	DCID (6010) "Mammography Calcification Types"
23			CODE	(111008, DCM, "Calcification Distribution")	1	UC	May be present only if value of parent is (F-01775,SRT, "Calcification Cluster")	DCID (6012) "Calcification Distribution Modifier"
24			NUM	(111038, DCM, "Number of calcifications")	1	UC	May be present only if value of parent is (F-01775,SRT, "Calcification Cluster")	UNITS = (1, UCUM, "no units") Value = Integer 1 – n
25			NUM	DCID (6142) Calculated Value	1-n	U		
26	>	HAS CONCEPT MOD	CODE	EV (121401, DCM, "Derivation")	1	M		DCID (6140) Calculation Methods
27	>	INFERRED FROM	TEXT	EV (112034, DCM, "Calculation Description")	1	U		

**Content Item Descriptions**

Certainty of Feature	The likelihood that the feature analyzed, and classified by the CODE specified in the Composite Feature parent template, is in fact that type of feature.
Volume Measurement	If dimensions for a volume are to be stated in terms of length, width, and depth, then one shall use 3 instances of TID (1400) Linear Measurement.

Row 11	Values $\leq 0$ are allowed. The two referenced numeric values are target content items of the first generation Composite Feature or Single Image Finding children of this composite feature. Given the equation, $A - B$ , the value representing A shall be referenced first.
Qualitative Difference	The two referenced code values are target content items of the first generation Composite Feature or Single Image Finding children of this composite feature.

**TID 4006 Mammography CAD Single Image Finding Template**

This template describes a single image finding for a lesion or other object. The details of the finding are expressed in this template and/or more specific templates. The details from which a single image Calcification Cluster is inferred may be expressed in a number of Single Image Findings (see TID 4006) of type Individual Calcification.

A Single Image Finding of type Breast Composition may be INFERRED FROM by-reference to a Single Image Finding of type Breast Geometry.

**TID 4006  
MAMMOGRAPHY CAD SINGLE IMAGE FINDING  
Type: Non-Extensible**

	NL	Rel with Parent	VT	Concept Name	VM	Req Type	Condition	Value Set Constraint
1			CODE	EV(111059, DCM, "Single Image Finding")	1	M		DCID (6014) "Mammography Single Image Finding"
2	>	HAS CONCEPT MOD	CODE	EV(111056, DCM, "Rendering Intent")	1	M		DCID (6034) "Intended Use of CAD Output"
3	>>	HAS PROPERTIES	NUM	(111071, DCM, "CAD Operating Point")	1	UC	IFF value of row 2 is (111151, DCM, "Presentation Optional") and row 9 of TID 4017 is present	UNITS = DT ({1:n}, UCUM, "range: 1:n"), where n is the maximum specified in Row 9 of TID 4017. Value is restricted to being an integer
4	>	HAS PROPERTIES	INCLUDE	DTID (4019) "CAD Algorithm Identification"	1	M		
5	>	HAS PROPERTIES	NUM	EV(111012, DCM, "Certainty of Finding")	1	U		UNITS = EV(% , UCUM, "Percent") Value = 0 – 100
6	>	HAS PROPERTIES	NUM	EV(111047, DCM, "Probability of cancer")	1	UC	May be present unless value of parent is (F-01710,SRT, "Breast composition"), (111100, DCM, "Breast geometry"), (T-04100, SNM3, "Nipple"), (111099, DCM, "Selected region"), (111101, DCM, "Image quality") or (111102, DCM, "Non-lesion")	UNITS = EV(% , UCUM, "Percent") Value = 0 – 100
7	>	HAS PROPERTIES	INCLUDE	DTID (4021) "Mammography CAD Geometry"	1	MC	Shall be present unless value of parent is (F-01710,SRT, "Breast composition"), (111100, DCM, "Breast geometry") or (111101, DCM, "Image quality")	
8	>	HAS PROPERTIES	INCLUDE	DTID (4007) "Mammography CAD Breast Composition"	1	MC	Shall be present only if value of parent is (F-01710,SRT, "Breast composition")	
9	>	R-INFERRED FROM	CODE		1-n	UC	May be present only if value of parent is (F-01710,SRT, "Breast composition")	Shall reference a (111059, DCM, "Single Image Finding") of value: EV (111100, DCM, "Breast geometry")
10	>	HAS PROPERTIES	INCLUDE	DTID (4008) "Mammography CAD Breast Geometry"	1	MC	Shall be present only if value of parent is (111100, DCM, "Breast geometry")	
11	>	HAS PROPERTIES	INCLUDE	DTID (4009) "Mammography CAD Individual Calcification"	1	UC	May be present only if value of parent is (F-01776,SRT, "Individual Calcification")	
12	>	HAS PROPERTIES	INCLUDE	DTID (4010) "Mammography CAD Calcification Cluster"	1	UC	May be present only if value of parent is (F-01775,SRT, "Calcification Cluster")	



	NL	Rel with Parent	VT	Concept Name	VM	Req Type	Condition	Value Set Constraint
13	>	HAS PROPERTIES	INCLUDE	DTID (4011) "Mammography CAD Density"	1	UC	May be present only if value of parent is (F-01796,SRT,"Mammography breast density")	
14	>	HAS PROPERTIES	CODE	EV(111297,DCM, "Nipple Characteristic")	1	UC	May be present only if value of parent is (T-04100, SNM3, "Nipple")	DCID (6039) "Nipple Characteristic"
15	>	HAS PROPERTIES	INCLUDE	DTID (4012) "Mammography CAD Non-Lesion"	1	MC	Shall be present only if value of parent is (111102, DCM, "Non-lesion")	
16	>	HAS PROPERTIES	INCLUDE	DTID (4013) "Mammography CAD Selected Region"	1	MC	Shall be present only if value of parent is (111099, DCM, "Selected Region")	
17	>	R-INFERRED FROM	IMAGE		1	MC	Shall be present only if value of parent is (111101, DCM, "Image quality") and row 18 is not present	Shall reference an IMAGE content item in the (111028, DCM, "Image Library")
18	>	HAS PROPERTIES	SCCOORD	EV(111030, DCM, "Image Region")	1-n	MC	Shall be present only if value of parent is (111101, DCM, "Image quality") and row 17 is not present	
19	>>	R-SELECTED FROM	IMAGE		1	M		All the (111030, DCM, "Image Region") content items in a single invocation of this template shall reference the same IMAGE content item in the (111028, DCM, "Image Library")
20	>	HAS PROPERTIES	INCLUDE	DTID (4014) "CAD Image Quality"	1-n	MC	Shall be present only if value of parent is (111101, DCM, "Image quality")	\$QualityFinding = DCID (6041) "Mammography Image Quality Finding", \$QualityStandard = DCID (6045) "Mammography Types of Quality Control Standard"
21	>	HAS PROPERTIES	NUM	DCID (6142) Calculated Value	1-n	U		
22	>>	HAS CONCEPT MOD	CODE	EV (121401, DCM, "Derivation")	1	M		DCID (6140) Calculation Methods
23	>>	INFERRED FROM	TEXT	EV (112034, DCM, "Calculation Description")	1	U		
24	>	INFERRED FROM	INCLUDE	DTID (4006) "Mammography CAD Single Image Finding"	1-n	UC	May be present only if value of parent is (F-01775,SRT, "Calcification Cluster")	EV (F-01776,SRT, "Individual Calcification")
25	>	HAS OBS CONTEXT	INCLUDE	DTID (4022) "CAD Observation Context"	1	MC	Shall be present only if this finding is incorporated from a different report than its parent.	

**Content Item Descriptions**

Rendering Intent	This content item constrains the SCP receiving the Mammography CAD SR IOD in its use of the contents of this template and its target content items. Mammography CAD devices may opt to use data marked "Not for Presentation" or "Presentation Optional" as input to subsequent mammography CAD processing steps. Refer to PS 3.4, Annex O Structured Reporting Storage SOP Classes for SCU and SCP Behavior.
------------------	---

CAD Operating Point	Additional information to use when Rendering Intent is "Presentation Optional". A CAD Operating Point of zero is not sent, and is encoded as a Rendering Intent of "Presentation Required". See PS 3.4 section on Structured Reporting Storage SOP Classes for SCU and SCP Behavior and PS 3.17 annex on Mammography.
Single Image Finding	A Single Image Finding (whose parent is a Single Image Finding of type Calcification Cluster) allows one level of nesting for the definition of individual calcifications within the cluster. To use this template recursively, this Single Image Finding code value shall be "Individual Calcification".
Certainty of Finding	The likelihood that the finding detected, and classified by the CODE specified in the Single Image Finding parent template, is in fact that type of finding.

**TID 4007 Mammography CAD Breast Composition Template**

**TID 4007  
MAMMOGRAPHY CAD BREAST COMPOSITION  
Type: Non-Extensible**

	NL	Rel with Parent	VT	Concept Name	VM	Req Type	Condition	Value Set Constraint
1			CODE	(F-01710,SRT, "Breast composition")	1	MC	At least one of row 1 or 2 shall be present	DCID (6000) "Overall Breast Composition"
2			NUM	(111046, DCM, "Percent Glandular Tissue")	1	MC	At least one of row 1 or 2 shall be present	UNITS = (% , UCUM, "Percent") Value = 0 – 100

**Content Item Descriptions**

Percent Glandular Tissue	Percent of breast area that is mammographically dense.
--------------------------	--

**TID 4008 Mammography CAD Breast Geometry Template**

**TID 4008  
MAMMOGRAPHY CAD BREAST GEOMETRY  
Type: Non-Extensible**

	NL	Rel with Parent	VT	Concept Name	VM	Req Type	Condition	Value Set Constraint
1			SCoord	(111007, DCM, "Breast Outline Including Pectoral Muscle Tissue")	1	M		GRAPHIC TYPE = {POLYLINE}
2	>	R-SELECTED FROM	IMAGE		1	M		Shall reference an IMAGE content item in the (111028, DCM, "Image Library")
3			SCoord	(111045, DCM, "Pectoral Muscle Outline")	1	U		GRAPHIC TYPE = {POLYLINE}
4	>	R-SELECTED FROM	IMAGE		1	M		Shall reference the same node as row 2

**Content Item Descriptions**

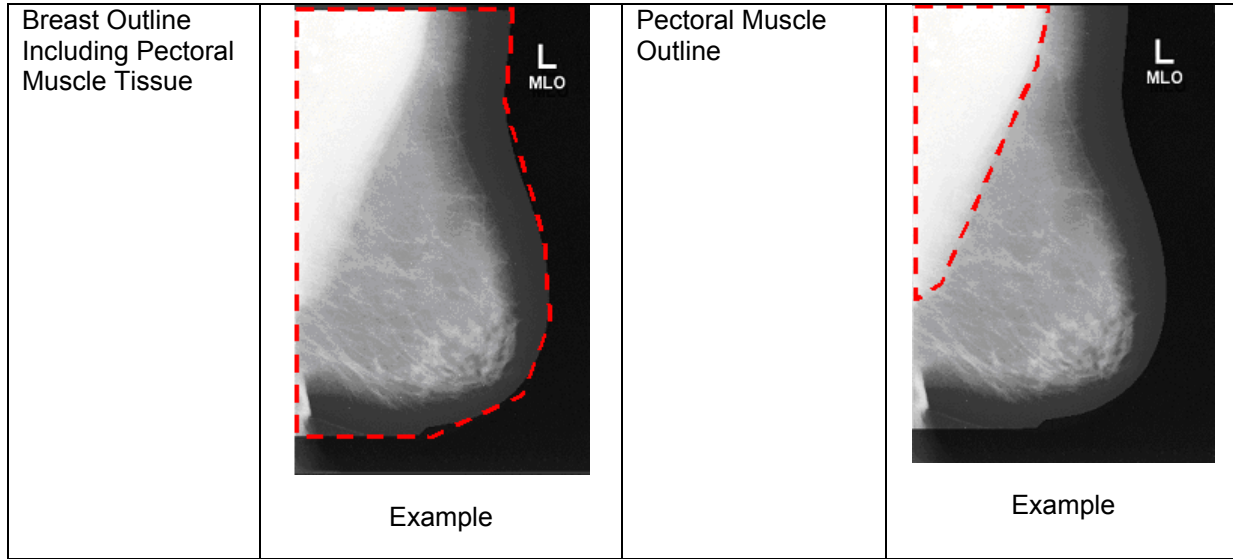

**TID 4009 Mammography CAD Individual Calcification Template**

This template provides the detail specific to an individual calcification.

**TID 4009  
MAMMOGRAPHY CAD INDIVIDUAL CALCIFICATION  
Type: Non-Extensible**

NL	Rel with Parent	VT	Concept Name	VM	Req Type	Condition	Value Set Constraint
1		CODE	(111009, DCM, "Calcification Type")	1-n	MC	At least one of rows 1, 2, 3 shall be present	DCID (6010) "Mammography Calcification Types"
2		INCLUDE	DTID (1400) "Linear Measurement"	1-n	MC	At least one of rows 1, 2, 3 shall be present	The by-reference relationship to the IMAGE in TID (1400) "Linear Measurement" shall be used.
3		INCLUDE	DTID (1401) "Area Measurement"	1-n	MC	At least one of rows 1, 2, 3 shall be present	The by-reference relationship to the IMAGE in TID (1401) "Area Measurement" shall be used.
4		INCLUDE	DTID (1402) "Volume Measurement"	1-n	U		The by-reference relationship to the IMAGE in TID (1402) "Volume Measurement" shall be used.

**TID 4010 Mammography CAD Calcification Cluster Template**

This template provides the detail specific to a calcification cluster.

**TID 4010  
MAMMOGRAPHY CAD CALCIFICATION CLUSTER  
Type: Non-Extensible**

NL	Rel with Parent	VT	Concept Name	VM	Req Type	Condition	Value Set Constraint
1		CODE	(111009, DCM, "Calcification Type")	1-n	MC	At least one of rows 1, 2, 3, 4, 5 shall be present	DCID (6010) "Mammography Calcification Types"

NL	Rel with Parent	VT	Concept Name	VM	Req Type	Condition	Value Set Constraint
2		CODE	(111008, DCM, "Calcification Distribution")	1	MC	At least one of rows 1, 2, 3, 4, 5 shall be present	DCID (6012) "Calcification Distribution Modifier"
3		NUM	(111038, DCM, "Number of calcifications")	1	MC	At least one of rows 1, 2, 3, 4, 5 shall be present	UNITS = (1, UCUM, "no units") Value = Integer >= 1
4		INCLUDE	DTID (1400) "Linear Measurement"	1-n	MC	At least one of rows 1, 2, 3, 4, 5 shall be present	The by-reference relationship to the IMAGE in TID (1400) "Linear Measurement" shall be used.
5		INCLUDE	DTID (1401) "Area Measurement"	1-n	MC	At least one of rows 1, 2, 3, 4, 5 shall be present	The by-reference relationship to the IMAGE in TID (1401) "Area Measurement" shall be used.
6		INCLUDE	DTID (1402) "Volume Measurement"	1-n	U		The by-reference relationship to the IMAGE in TID (1402) "Volume Measurement" shall be used.

**TID 4011 Mammography CAD Density Template**

This template provides the detail specific to a density.

**TID 4011  
MAMMOGRAPHY CAD DENSITY  
Type: Non-Extensible**

NL	Rel with Parent	VT	Concept Name	VM	Req Type	Condition	Value Set Constraint
1		CODE	(111035, DCM, "Lesion Density")	1	MC	At least one of rows 1, 2, 3, 4, 5 shall be present	DCID (6008) "Density Modifier"
2		CODE	(M-020F9, SNM3, "Shape")	1	MC	At least one of rows 1, 2, 3, 4, 5 shall be present	DCID (6004) "Mammography Characteristics of Shape"
3		CODE	(111037, DCM, "Margins")	1-n	MC	At least one of rows 1, 2, 3, 4, 5 shall be present	DCID (6006) "Mammography Characteristics of Margin"
4		INCLUDE	DTID (1400) "Linear Measurement"	1-n	MC	At least one of rows 1, 2, 3, 4, 5 shall be present	The by-reference relationship to the IMAGE in TID (1400) "Linear Measurement" shall be used.
5		INCLUDE	DTID (1401) "Area Measurement"	1-n	MC	At least one of rows 1, 2, 3, 4, 5 shall be present	The by-reference relationship to the IMAGE in TID (1401) "Area Measurement" shall be used.
6		INCLUDE	DTID (1402) "Volume Measurement"	1-n	U		The by-reference relationship to the IMAGE in TID (1402) "Volume Measurement" shall be used.

**TID 4012 Mammography CAD Non-Lesion Template**

This template provides the detail specific to a finding other than a lesion (see CID 6040).

**TID 4012  
MAMMOGRAPHY CAD NON-LESION  
Type: Non-Extensible**

	NL	Rel with Parent	VT	Concept Name	VM	Req Type	Condition	Value Set Constraint
1			CODE	(111039, DCM, "Object type")	1	M		DCID (6040) "Non-Lesion Object Type"
2			INCLUDE	DTID (1400) "Linear Measurement"	1-n	U		The by-reference relationship to the IMAGE in TID (1400) "Linear Measurement" shall be used.
3			INCLUDE	DTID (1401) "Area Measurement"	1-n	U		The by-reference relationship to the IMAGE in TID (1401) "Area Measurement" shall be used.
4			INCLUDE	DTID (1402) "Volume Measurement"	1-n	U		The by-reference relationship to the IMAGE in TID (1402) "Volume Measurement" shall be used.

**TID 4013 Mammography CAD Selected Region Template**

This template provides the detail specific to a selected region. A selected region is any mammography CAD derived arbitrary region of the image, whether within the breast outline or not. This can be use to delineate regions such as the intramammary fold.

**TID 4013  
MAMMOGRAPHY CAD SELECTED REGION  
Type: Non-Extensible**

	NL	Rel with Parent	VT	Concept Name	VM	Req Type	Condition	Value Set Constraint
1			TEXT	(111058, DCM, "Selected Region Description")	1	M		
2			INCLUDE	DTID (1400) "Linear Measurement"	1-n	U		The by-reference relationship to the IMAGE in TID (1400) "Linear Measurement" shall be used.
3			INCLUDE	DTID (1401) "Area Measurement"	1-n	U		The by-reference relationship to the IMAGE in TID (1401) "Area Measurement" shall be used.
4			INCLUDE	DTID (1402) "Volume Measurement"	1-n	U		The by-reference relationship to the IMAGE in TID (1402) "Volume Measurement" shall be used.

**TID 4014 CAD Image Quality Template**

This template provides the detail specific to image quality. It allows the encoding of descriptors of image quality (e.g., CID 6041) for a given image or region of an image. For instance, images with partial motion blur can be identified with the region noted.

Parameter Name	Parameter Usage
\$QualityFinding	Coded term or Context Group for Quality Finding
\$QualityStandard	Coded term or Context Group for Quality Control Standard

**TID 4014**  
**CAD IMAGE QUALITY**  
Type: Non-Extensible

NL	Rel with Parent	VT	Concept Name	VM	Req Type	Condition	Value Set Constraint
1		CODE	EV(111052, DCM, "Quality Finding")	1	M		\$QualityFinding
2	> HAS PROPERTIES	CODE	EV(111050, DCM, "Quality Assessment")	1	U		DCID (6044) "Types of Image Quality Assessment"
3	> HAS PROPERTIES	CODE	EV(111051, DCM, "Quality Control Standard")	1	UC	Shall be present if row 2 is present.	\$QualityStandard
4	> HAS PROPERTIES	NUM	EV(111029, DCM, "Image Quality Rating")	1	U		UNITS = EV({0:100}, UCUM, "range:0:100") Value = 0 – 100

**Content Item Descriptions**

Image Quality Rating	A numeric value in the range 0 to 100, inclusive, where 0 is worst quality and 100 is best quality.
----------------------	---

**TID 4015 CAD Detections Performed Template**

This template gathers two lists of detection algorithms attempted, grouped by success/failure status. Algorithms not attempted are not mentioned in this sub-tree of the Document Root (e.g., TID 4000). This information forms the basis for understanding why a CAD report may produce no (or fewer than anticipated) detection results.

The sub-tree formed by this template is illustrated in PS 3.17 in the Annex on Mammography CAD SR Content Tree Structure.

Parameter Name	Parameter Usage
\$DetectionCode	Coded term or Context Group for Detection Performed

**TID 4015**  
**CAD DETECTIONS PERFORMED**  
Type: Non-Extensible

NL	Rel with Parent	VT	Concept Name	VM	Req Type	Condition	Value Set Constraint
1		CONTAINER	EV(111063, DCM, "Successful Detections")	1	MC	Shall be present only if value of parent is (111222, DCM, "Succeeded") or (111223, DCM, "Partially Succeeded")	

	NL	Rel with Parent	VT	Concept Name	VM	Req Type	Condition	Value Set Constraint
2	>	CONTAINS	INCLUDE	DTID (4017) "CAD Detection Performed"	1-n	M		\$DetectionCode = \$DetectionCode
3			CONTAINER	EV(111025, DCM, "Failed Detections")	1	MC	Shall be present only if value of parent is (111224, DCM, "Failed") or (111223, DCM, "Partially Succeeded")	
4	>	CONTAINS	INCLUDE	DTID (4017) "CAD Detection Performed"	1-n	M		\$DetectionCode = \$DetectionCode

### TID 4016 CAD Analyses Performed Template

This template gathers two lists of analysis algorithms attempted, grouped by success/failure status. Algorithms not attempted are not mentioned in this sub-tree of the Document Root (e.g., TID 4000). This information forms the basis for understanding why a CAD report may produce no (or fewer than anticipated) analysis results.

The sub-tree formed by this template is illustrated in PS 3.17 in the Annex on Mammography CAD SR Content Tree Structure.

Parameter Name	Parameter Usage
\$AnalysisCode	Coded term or Context Group for Analysis Performed

### TID 4016 CAD ANALYSES PERFORMED Type: Non-Extensible

	NL	Rel with Parent	VT	Concept Name	VM	Req Type	Condition	Value Set Constraint
1			CONTAINER	EV(111062, DCM, "Successful Analyses")	1	MC	Shall be present only if value of parent is (111222, DCM, "Succeeded") or (111223, DCM, "Partially Succeeded")	
2	>	CONTAINS	INCLUDE	DTID (4018) "CAD Analysis Performed"	1-n	M		\$AnalysisCode=\$AnalysisCod e
3			CONTAINER	EV(111024, DCM, "Failed Analyses")	1	MC	Shall be present only if value of parent is (111224, DCM, "Failed") or (111223, DCM, "Partially Succeeded")	
4	>	CONTAINS	INCLUDE	DTID (4018) "CAD Analysis Performed"	1-n	M		\$AnalysisCode=\$AnalysisCod e

### TID 4017 CAD Detection Performed Template

This template fully identifies a detection algorithm and the images and/or image regions on which it operated (see TID 4015).

Parameter Name	Parameter Usage
\$DetectionCode	Coded term or Context Group for Detection Performed



**TID 4017**  
**CAD DETECTION PERFORMED**  
**Type: Non-Extensible**

	NL	Rel with Parent	VT	Concept Name	VM	Req Type	Condition	Value Set Constraint
1			CODE	EV(111022, DCM, "Detection Performed")	1	M		\$DetectionCode
2	>	HAS PROPERTIES	INCLUDE	DTID (4019) "CAD Algorithm Identification"	1	M		
3	>	HAS PROPERTIES	IMAGE		1-n	MC	At least one of row 3, 4, 5 or 6 shall be present	
4	>	R-HAS PROPERTIES	IMAGE		1-n	MC	At least one of row 3,4,5 or 6 shall be present	Shall reference IMAGE content item(s) in the (111028, DCM, "Image Library")
5	>	HAS PROPERTIES	UIDREF	EV(112002,DCM,"Series Instance UID")	1-n	MC	At least one of row 3,4,5 or 6 shall be present	
6	>	HAS PROPERTIES	SCCOORD	EV(111030, DCM, "Image Region")	1-n	MC	At least one of row 3,4,5 or 6 shall be present	
7	>>	SELECTED FROM	IMAGE		1	MC	XOR row 8	
8	>>	R-SELECTED FROM	IMAGE		1	MC	XOR row 7	Shall reference an IMAGE content item in the (111028, DCM, "Image Library")
9	>		INCLUDE	DTID (4023) CAD Operating Points	1	U		

**Content Item Descriptions**

CAD Algorithm Identification	If more than one detection algorithm has the same "Detection Performed" code value (e.g., CID 6014) then the "CAD Algorithm Identification" shall unambiguously distinguish between algorithms.
Rows 3 - 6	When this template is invoked for the Mammography CAD SR, the Image Library is mandatory, thus only row 4 and/or row 6 shall be present. When this template is invoked for the Chest CAD SR, the Image Library is optional, thus any combination of rows 3, 4, 5 and 6 may be present.
Rows 7 - 8	When this template is invoked for the Mammography CAD SR, the Image Library is mandatory, thus only row 8 shall be present. When this template is invoked for the Chest CAD SR, the Image Library is optional, thus row 7 or 8 may be present.

**TID 4018 CAD Analysis Performed Template**

This template fully identifies an analysis algorithm and the images and/or image regions on which it operated (see TID 4016).

Parameter Name	Parameter Usage
\$AnalysisCode	Coded term or Context Group for Analysis Performed

**TID 4018**  
**CAD ANALYSIS PERFORMED**  
**Type: Non-Extensible**

NL	Rel with Parent	VT	Concept Name	VM	Req Type	Condition	Value Set Constraint
1		CODE	EV(111004, DCM, "Analysis Performed")	1	M		\$AnalysisCode
2	>	HAS PROPERTIES	INCLUDE DTID (4019) "CAD Algorithm Identification"	1	M		
3	>	HAS PROPERTIES	IMAGE	1-n	MC	At least one of row 3, 4, 5 or 6 shall be present	
4	>	R-HAS PROPERTIES	IMAGE	1-n	MC	At least one of row 3, 4, 5 or 6 shall be present	Shall reference IMAGE content item(s) in the (111028, DCM, "Image Library")
5	>	HAS PROPERTIES	UIDREF EV(112002,DCM,"Series Instance UID")	1-n	MC	At least one of row 3, 4, 5 or 6 shall be present	
6	>	HAS PROPERTIES	SCoord EV(111030, DCM, "Image Region")	1-n	MC	At least one of row 3, 4, 5 or 6 shall be present	
7	>>	SELECTED FROM	IMAGE	1	MC	XOR Row 8	
8	>>	R-SELECTED FROM	IMAGE	1	MC	XOR Row 7	Shall reference an IMAGE content item in the (111028, DCM, "Image Library")

**Content Item Descriptions**

CAD Algorithm Identification	If more than one analysis algorithm has the same "Analysis Performed" code value (e.g., CID 6043) then the "CAD Algorithm Identification" shall unambiguously distinguish between algorithms.
Rows 3 - 6	When this template is invoked for the Mammography CAD SR, the Image Library is mandatory, and a total of at least two instances of row 4 or row 6 shall be present. When this template is invoked for the Chest CAD SR, the Image Library is optional, thus any combination of rows 3, 4, 5 and 6 may be present.
Rows 7 - 8	When this template is invoked for the Mammography CAD SR, the Image Library is mandatory, thus only row 8 shall be present. When this template is invoked for the Chest CAD SR, the Image Library is optional, thus row 7 or 8 may be present.

**TID 4019 CAD Algorithm Identification Template**

This template details the algorithm unambiguously. Re-state the software identification from the General Equipment Module of the SR IOD if all algorithms are unambiguously defined by that module.

**TID 4019**  
**CAD ALGORITHM IDENTIFICATION**  
**Type: Non-Extensible**

	<b>NL</b>	<b>Rel with Parent</b>	<b>VT</b>	<b>Concept Name</b>	<b>VM</b>	<b>Req Type</b>	<b>Condition</b>	<b>Value Set Constraint</b>
1			TEXT	EV(111001, DCM, "Algorithm Name")	1	M		
2			TEXT	EV (111003, DCM, "Algorithm Version")	1	M		
3			TEXT	EV (111002, DCM, "Algorithm Parameters")	1-n	U		

**TID 4020 CAD Image Library Entry Template**

Each instance of the Image Library Entry template contains the Image SOP Class and Instance UIDs, and selected attributes for an image. If values for the attributes are not present in the Image SOP Instance, then as many of the attributes as possible should be derived.

Parameter Name	Parameter Usage
\$ImageLaterality	Coded term or Context Group for Image Laterality
\$ImageView	Coded term or Context Group for Image View
\$ImageViewMod	Coded term or Context Group for Image View Modifier

**TID 4020  
CAD IMAGE LIBRARY ENTRY  
Type: Non-Extensible**

	NL	Rel with Parent	VT	Concept Name	VM	Req Type	Condition	Value Set Constraint
1			IMAGE		1	M		
2	>	HAS ACQ CONTEXT	CODE	EV(111027, DCM, "Image Laterality")	1	MC	Shall be present if (0020,0062) is in the Image Instance	\$ImageLaterality
3	>	HAS ACQ CONTEXT	CODE	EV (111031, DCM, "Image View")	1	MC	Shall be present if (0054,0220) is in the Image Instance	\$ImageView
4	>>	HAS CONCEPT MOD	CODE	EV (111032, DCM, "Image View Modifier")	1-n	MC	Shall be present if (0054,0222) is in the Image Instance	\$ImageViewMod
5	>	HAS ACQ CONTEXT	TEXT	EV (111044, DCM, "Patient Orientation Row")	1	MC	Shall be present if (0020,0020) is in the Image Instance	
6	>	HAS ACQ CONTEXT	TEXT	EV (111043, DCM, "Patient Orientation Column")	1	MC	Shall be present if (0020,0020) is in the Image Instance	
7	>	HAS ACQ CONTEXT	DATE	EV (111060, DCM, "Study Date")	1	MC	Shall be present if (0008,0020) is in the Image Instance	
8	>	HAS ACQ CONTEXT	TIME	EV (111061, DCM, "Study Time")	1	MC	Shall be present if (0008,0030) is in the Image Instance	
9	>	HAS ACQ CONTEXT	DATE	EV (111018, DCM, "Content Date")	1	MC	Shall be present if (0008,0023) is in the Image Instance	
10	>	HAS ACQ CONTEXT	TIME	EV (111019, DCM, "Content Time")	1	MC	Shall be present if (0008,0033) is in the Image Instance	
11	>	HAS ACQ CONTEXT	NUM	EV (111026, DCM, "Horizontal Pixel Spacing")	1	MC	Shall be present if (0018,1164) or (0028,0030) is in the Image Instance	UNITS = EV (um, UCUM, "micrometer")
12	>	HAS ACQ CONTEXT	NUM	EV (111066, DCM, "Vertical Pixel Spacing")	1	MC	Shall be present if (0018,1164) or (0028,0030) is in the Image Instance	UNITS = EV (um, UCUM, "micrometer")
13	>	HAS ACQ CONTEXT	NUM	EV (112011, DCM, "Positioner Primary Angle")	1	UC	May be present if (0018,1510) is in the Image Instance	
14	>	HAS ACQ CONTEXT	NUM	EV (112012, DCM, "Positioner Secondary Angle")	1	UC	May be present if (0018,1511) is in the Image Instance	

**Content Item Descriptions**

Patient Orientation Row	First (row) and Second (column) components of Patient Orientation (0020.0020) in the Image IOD. See PS 3, C.7.6.1.1.1.
-------------------------	--

Patient Orientation Column	(0020,0020) in the Image IOD. See PS 3, C.7.6.1.1.1.
Horizontal Imager Pixel Spacing	The row (first) component of Imager Pixel Spacing (0018,1164) in the Image IOD. See PS 3, C.8.11.4. Convert the source spacing to micrometers.
Vertical Imager Pixel Spacing	The column (second) component of Imager Pixel Spacing (0018,1164) in the Image IOD. See PS 3, C.8.11.4. Convert the source spacing to micrometers.

**TID 4021 Mammography CAD Geometry Template**

All geometry template invocations require specification of the location of the center of the object. Outline is optional.

**TID 4021  
MAMMOGRAPHY CAD GEOMETRY  
Type: Non-Extensible**

	NL	Rel with Parent	VT	Concept Name	VM	Req Type	Condition	Value Set Constraint
1			SCoord	EV(111010, DCM, "Center")	1	M		GRAPHIC TYPE = {POINT}
2	>	R-SELECTED FROM	IMAGE		1	M		Shall reference an IMAGE content item in the (111028, DCM, "Image Library")
3			SCoord	EV(111041, DCM, "Outline")	1	U		
4	>	R-SELECTED FROM	IMAGE		1	M		Shall reference the same content item as row 2
5			SCoord	DCID (6166) CAD Geometry Secondary Graphical Representation	1-n	U		
6	>	R-SELECTED FROM	IMAGE		1	M		Shall reference the same content item as row 2

**TID 4022 CAD Observation Context Template**

This template is invoked when a content item, which may be the "root" of a sub-tree, is paraphrased from a prior SR document.

**TID 4022  
CAD OBSERVATION CONTEXT  
Type: Non-Extensible**

	NL	Rel with Parent	VT	Concept Name	VM	Req Type	Condition	Value Set Constraint
1			COMPOSITE	EV(111040, DCM, "Original Source")	1	MC	Shall be present if the original source is a DICOM object.	
2	>	HAS CONCEPT MOD	INCLUDE	DTID (1204) "Language of Content Item and Descendants"	1	M		
3			INCLUDE	DTID (1001) "Observation Context"	1	M		

**TID 4023 CAD Operating Points**

This template describes CAD operating points. The description is deliberately left flexible and optional to allow implementation at differing levels of complexity.

**TID 4023  
CAD OPERATING POINTS  
Type: Non-Extensible**

	NL	Rel with Parent	VT	Concept Name	VM	Req Type	Condition	Value Set Constraint
1		HAS	NUM	(111072, DCM, "Maximum	1	M		UNITS = DT ([arb'U], UCUM,

	NL	Rel with Parent	VT	Concept Name	VM	Req Type	Condition	Value Set Constraint
		PROPERTIES		CAD Operating Point")				"arbitrary unit") Value is restricted to being an integer
2		HAS PROPERTIES	NUM	(111092, DCM, "Recommended CAD Operating Point")	1	U		UNITS = DT ({0:n}, UCUM, "range: 0:n"), where n is the value specified in row 1 Value is restricted to being an integer
3		HAS PROPERTIES	CONTAINER	(111093,DCM,"CAD Operating Point Table")	1	U		
4	>	CONTAINS	CODE	(122698, DCM, "X-Concept")	1	M		DCID (6048) CAD Operating Point Axis Label
5	>	CONTAINS	CODE	(122699, DCM, "Y-Concept")	1	M		DCID (6048) CAD Operating Point Axis Label
6	>	CONTAINS	NUM	(111071, DCM, "CAD Operating Point")	1-n	M	Number of instances of this row shall equal value of row 1, plus 1.	UNITS = DT ({0:n}, UCUM, "range: 0:n"), where n is the value of Row 1. Value is restricted to being an integer that is unique within the invocation of this template.
7	>>	HAS PROPERTIES	TEXT	(111081, DCM, "CAD Operating Point Description")	1	U		
8	>>	HAS PROPERTIES	NUM	The value of Row 4	1	M		
9	>>	HAS PROPERTIES	NUM	The value of Row 5	1	M		

### Content Item Descriptions

Maximum CAD Operating Point	The maximum possible value of CAD Operating Point for this type of Detection Performed. No CAD Operating Point value recorded in the CAD Processing and Findings Summary sub-tree of the report for this type of Detection Performed shall exceed this value. The report may or may not contain Rendering Intent = "Presentation Optional" detections that are assigned the maximum value.
Recommended CAD Operating Point	A number indicating which of the CAD operating points is recommended by the creator of a CAD SR instance as the first operating point to be used when rendering the CAD SR instance contents. Subsequent changes to the displayed operating point are implementation dependent.

### CHEST CAD SR IOD TEMPLATES

The templates that comprise the Chest CAD SR IOD are interconnected as in Figure A-9. In Figure A-9, '•••' indicates possible recursive application of subordinate templates.

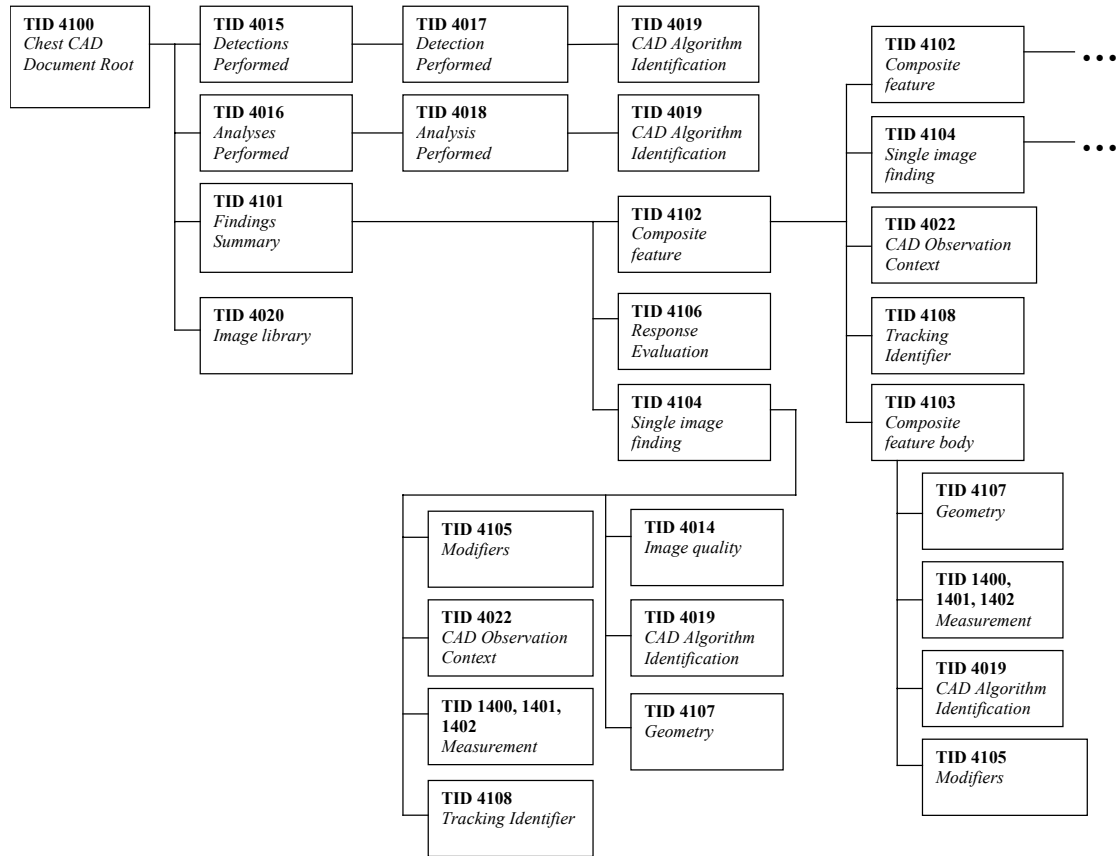

Figure A-9: Chest CAD SR IOD Template Structure



**TID 4100 Chest CAD Document Root Template**

This template forms the top of a content tree that allows a chest CAD device to describe the results of detection and analysis of chest evidence. This template, together with its subordinate templates, describes both the results for presentation to radiologists and partial product results for consumption by chest CAD devices in subsequent chest CAD reports.

This template defines a Container that contains an Image Library, the CAD results, and summaries of the detection and analysis algorithms performed. The Image Library contains the Image SOP Class and Instance UIDs, and selected attributes for each image referenced in either the algorithm summaries or chest CAD results.

The atomic CAD results of Single Image Findings and Composite Features are described in the Chest CAD Findings Summary sub-tree.

The Summary of Detections and Summary of Analyses sub-trees gather lists of algorithms attempted, grouped by success/failure status. Algorithms not attempted are not mentioned in these sub-trees. This information forms the basis for understanding why a chest CAD report may produce no (or fewer than anticipated) results. Chest CAD results are constructed bottom-up, starting from Single Image Findings (see TID 4104), associated as Composite Features (see TID 4102).

See the figure entitled "Top Levels of Chest CAD SR Content Tree" in the "Chest CAD" Annex of PS 3.17.

**TID 4100  
CHEST CAD DOCUMENT ROOT  
Type: Non-Extensible**

NL	Rel with Parent	VT	Concept Name	VM	Req Type	Condition	Value Set Constraint
1		CONTAINER	EV (112000, DCM, "Chest CAD Report")	1	M		
2	>	HAS CONCEPT MOD	INCLUDE DTID (1204) Language of Content Item and Descendants	1	M		
3	>	CONTAINS	CONTAINER EV (111028, DCM, "Image Library")	1	U		
4	>>	CONTAINS	INCLUDE DTID (4020) CAD Image Library Entry	1-n	M		\$ImageLaterality = DCID (244) Laterality \$ImageView = DCID (4010) DX View \$ImageViewMod = DCID (4011) DX View Modifier
5	>	CONTAINS	INCLUDE DTID (4101) Chest CAD Findings Summary	1	M		
6	>	CONTAINS	CODE EV (111064, DCM, "Summary of Detections")	1	M		DCID (6042) Status of Results
7	>>	INFERRED FROM	INCLUDE DTID (4015) CAD Detections Performed	1	MC	Shall be present unless the value of row 6 is (11225, DCM, "Not Attempted")	\$DetectionCode = DCID (6101) Chest Finding or Feature, DCID (6102) Chest Finding or Feature Modifier
8	>	CONTAINS	CODE EV (111065, DCM, "Summary of Analyses")	1	M		DCID (6042) Status of Results
9	>>	INFERRED FROM	INCLUDE DTID (4016) CAD Analyses Performed	1	MC	Shall be present unless the value of row 8 is (11225, DCM, "Not Attempted")	\$AnalysisCode = DCID (6137) Types of Chest CAD Analysis

**Content Item Descriptions**

Image Library	The "Image Library" section of the Content Tree (TID 4100, row 3) may include all Image SOP Instances from the Current Requested Procedure
---------------	--

	<p>Evidence Sequence (0040,A375) attribute of the SR Document General module. If a portion of another instance of a Chest CAD SR IOD is duplicated in the "Chest CAD Findings Summary" section of the Content Tree, the "Image Library" may also include all Image Library Entries referenced from the duplicated portions of the Chest CAD SR.</p> <p>The Image Library is intended to be used in cases where the acquisition context content items differ from image to image, such as different views and/or laterality in projection X-ray.</p>
Detections Performed	The "Detections Performed" and "Analyses Performed" sections of the Content Tree (TID 4100, rows 7 and 9) together shall reference all Image SOP Instances included in the Current Requested Procedure Evidence Sequence (0040,A375) attribute of the SR Document General module.
Analyses Performed	

**TID 4101 Chest CAD Findings Summary Template**

The contents of this template describe the findings and aggregate features that the chest CAD device detected for the chest evidence presented. This template forms the chest CAD results sub-tree of the Chest CAD Document Root (TID 4100). The data from which the details are inferred are expressed in the Composite Features (see TID 4102) and/or Single Image Findings (see TID 4104), of which there may be several.

The sub-tree headed by this template is illustrated in the figure entitled “Example of CAD Processing and Findings Summary sub-tree of Chest CAD SR Content Tree” in the “Chest CAD” Annex of PS 3.17.

**TID 4101  
CHEST CAD FINDINGS SUMMARY  
Type: Non-Extensible**

NL	Rel with Parent	VT	Concept Name	VM	Req Type	Condition	Value Set Constraint
1		CODE	EV (111017, DCM, “CAD Processing and Findings Summary”)	1	M		DCID (6047) CAD Processing and Findings Summary
2	> INFERRED FROM	INCLUDE	DTID (4102) Chest CAD Composite Feature	1-n	U		
3	> INFERRED FROM	INCLUDE	DTID (4104) Chest CAD Single Image Finding	1-n	U		
4	> HAS PROPERTIES	INCLUDE	DTID (4106) Response Evaluation	1-n	U		

**Content Item Descriptions**

CAD Processing and Findings Summary	<p>This code value is used to express if and why the Chest CAD Findings Summary sub-tree is empty. The Summary of Detections and Summary of Analyses sub-trees of the Document Root node contain detail about which (if any) algorithms succeeded or failed.</p> <p>If the code value indicates that there were no findings, then the code value can be used to determine whether chest CAD processing occurred successfully, without parsing the Summary of Detections and Summary of Analyses sub-trees.</p>
-------------------------------------	--

**TID 4102 Chest CAD Composite Feature Template**

This template collects a composite feature for a lesion, anatomy, non-lesion object, or correlation of related objects (see TID 4101). The details of the composition are expressed in the Chest CAD Composite Feature Body (see TID 4103). The data from which the details are inferred, are expressed in the Composite Features (see TID 4102) and/or Single Image Findings (see TID 4104), of which there may be several.

A Composite Feature shall be INFERRED FROM any combination of two or more Composite Features or Single Image Findings or mixture thereof.

**TID 4102**  
**CHEST CAD COMPOSITE FEATURE**  
Type: Non-Extensible

NL	Rel with Parent	VT	Concept Name	VM	Req Type	Condition	Value Set Constraint
1		CODE	EV (111015, DCM, "Composite Feature")	1	M		DCID (6101) Chest Finding or Feature
2	> HAS CONCEPT MOD	CODE	EV (112023, DCM, "Composite Feature Modifier")	1	U		DCID (6102) Chest Finding or Feature Modifier
3	> HAS CONCEPT MOD	TEXT	EV (112050, DCM, "Anatomic Identifier")	1	U		
4	> HAS CONCEPT MOD	CODE	EV (112003, DCM, "Associated Chest Component")	1	MC	Shall be present IFF value of row 1 is (112005, DCM, "Radiographic anatomy")	DCID (6100) Chest Component Categories
5	> HAS CONCEPT MOD	CODE	EV (112037, DCM, "Non-lesion Modifier")	1	UC	May be present IFF value of row 1 is (111102, DCM, "Non-lesion")	DCID (6139) Non-lesion Modifiers
6	> HAS CONCEPT MOD	CODE	EV (112038, DCM, "Osseous Modifier")	1	UC	May be present IFF value of row 2 is from DCID (6114) Osseous Anatomy Finding or Feature	DCID (6115) Osseous Anatomy Modifiers
7	> HAS CONCEPT MOD	CODE	EV (111056, DCM, "Rendering Intent")	1	M		DCID (6034) Intended Use of CAD Output
8	> HAS OBS CONTEXT	INCLUDE	DTID (4108) Tracking Identifier	1	U		
9	> HAS OBS CONTEXT	CODE	EV (112016, DCM, "Baseline Category")	1	U		DCID (6145) Baseline Category
10	> HAS OBS CONTEXT	INCLUDE	DTID (4022) CAD Observation Context	1	MC	Shall be present IFF this feature is duplicated from a different report than its parent.	
11	> HAS OBS CONTEXT	INCLUDE	DTID (4019) CAD Algorithm Identification	1	M		
12	> HAS PROPERTIES	INCLUDE	DTID (4103) Chest CAD Composite Feature Body	1	M		
13	> INFERRED FROM	INCLUDE	DTID (4102) Chest CAD Composite Feature	1-n	MC	At least two items shall be present: two of row 13, two of row 14, or one of each.	
14	> INFERRED FROM	INCLUDE	DTID (4104) Chest CAD Single Image Finding	1-n	MC	At least two items shall be present: two of row 13, two of row 14, or one of each.	

### Content Item Descriptions

Anatomic Identifier	An identifier of an anatomic feature when a multiplicity of features of that type may be present, such as “Rib 1”, “Rib 2” or thoracic vertebrae “T1” or “T2”.
Rendering Intent	This content item constrains the SCP receiving the Chest CAD SR IOD in its use of the contents of this template and its target content items. Chest CAD devices may opt to use data marked “Not for Presentation” or “Presentation Optional” as input to subsequent chest CAD processing steps. Refer to PS 3.4, Annex O Structured Reporting Standard SOP Classes for SCU and SCP Behavior.

**TID 4103 Chest CAD Composite Feature Body Template**

The details of a composite feature are expressed in this template. It is applied to Chest CAD Composite Feature (TID 4102).

**TID 4103  
CHEST CAD COMPOSITE FEATURE BODY  
Type: Non-Extensible**

NL	Rel with Parent	VT	Concept Name	VM	Req Type	Condition	Value Set Constraint
1		CODE	EV (111016, DCM, "Composite type")	1	M		DCID (6035) Composite Feature Relations
2		CODE	EV (111057, DCM, "Scope of Feature")	1	M		DCID (6036) Scope of Feature
3		NUM	EV (111011, DCM, "Certainty of feature")	1	U		UNITS = EV (% , UCUM, "Percent") Value = 0 – 100
4		INCLUDE	DTID (4107) Chest CAD Geometry	1	U		
5		INCLUDE	DTID (1400) Linear Measurement	1-n	U		
6		INCLUDE	DTID (1401) Area Measurement	1-n	U		
7		INCLUDE	DTID (1402) Volume Measurement	1-n	U		
8		INCLUDE	DTID (4105) Chest CAD Descriptors	1	U		
9		NUM	DCID (6133) Chest Quantitative Temporal Difference Type	1-n	UC	May be present IFF the value of row 1 is (111153, DCM, "Target content items are related temporally")	
10>	R-INFERRED FROM	NUM		2	U		The referenced numeric values shall have the same Concept Name. Their UNITS shall be the same as row 9
11		CODE	EV (111049, DCM, "Qualitative Difference")	1-n	UC	May be present only if the value of row 1 is (111153, DCM, "Target content items are related temporally")	DCID (6134) Chest Qualitative Temporal Difference Type
12>	HAS PROPERTIES	TEXT	EV (111021, DCM, "Description of Change")	1	U		
13>	R-INFERRED FROM	CODE		2	M		The referenced content items shall have the same Concept Name and their code values shall be from the same context group.

**Content Item Descriptions**

Certainty of Feature	The certainty of the CAD device that the feature analyzed and classified by the CODE, as specified in the <sup>Composite</sup> Feature parent template, is in fact that type of feature.
Volume Measurement	If dimensions for a volume are to be stated in terms of length, width, and depth, then one shall use 3 instances of TID (1400) Linear Measurement.
Row 9	Values ≤ 0 are allowed. The two referenced numeric values are target content items of the first generation Composite Feature or Single Image

	Finding children of this composite feature. Given the equation, $A - B$ , the value representing A shall be referenced first.
Qualitative Difference	The two referenced code values are target content items of the first generation Composite Feature or Single Image Finding children of this composite feature.

**TID 4104 Chest CAD Single Image Finding Template**

This template describes a single image finding for a lesion or other object. The details of the finding are expressed in this template and/or more specific templates.

**TID 4104  
CHEST CAD SINGLE IMAGE FINDING  
Type: Non-Extensible**

	NL	Rel with Parent	VT	Concept Name	VM	Req Type	Condition	Value Set Constraint
1			CODE	EV (111059, DCM, "Single Image Finding")	1	M		DCID (6101) Chest Finding or Feature
2	>	HAS CONCEPT MOD	CODE	EV (112024, DCM, "Single Image Finding Modifier")	1	U		DCID (6102) Chest Finding or Feature Modifier
3	>	HAS CONCEPT MOD	TEXT	EV (112050, DCM, "Anatomic Identifier")	1	U		
4	>	HAS CONCEPT MOD	CODE	EV (112003, DCM, "Associated Chest Component")	1	MC	Shall be present IFF value of row 1 is (112005, DCM, "Radiographic anatomy")	DCID (6100) Chest Component Categories
5	>	HAS CONCEPT MOD	CODE	EV (112037, DCM, "Non-lesion Modifier")	1	UC	May be present IFF value of row 1 is (111102, DCM, "Non-lesion")	DCID (6139) Non-lesion Modifiers
6	>	HAS CONCEPT MOD	CODE	EV (111056, DCM, "Rendering Intent")	1	M		DCID (6034) Intended Use of CAD Output
7	>>	HAS PROPERTIES	NUM	(111071, DCM, "CAD Operating Point")	1	UC	IFF value of row 6 is (111151, DCM, "Presentation Optional") and row 9 of TID 4017 is present	UNITS = DT ({{1:n}}, UCUM, "range: 1:n"), where n is the maximum specified in Row 9 of TID 4017. Value is restricted to being an integer
8	>	HAS OBS CONTEXT	INCLUDE	DTID (4108) Tracking Identifier	1	U		
9	>	HAS OBS CONTEXT	CODE	EV (112016, DCM, "Baseline Category")	1	U		DCID (6145) Baseline Category
10	>	HAS OBS CONTEXT	INCLUDE	DTID (4022) CAD Observation Context	1	MC	Shall be present IFF this finding is duplicated from a different report than its parent.	
11	>	HAS OBS CONTEXT	INCLUDE	DTID (4019) CAD Algorithm Identification	1	M		
12	>	HAS PROPERTIES	NUM	EV (111012, DCM, "Certainty of Finding")	1	U		UNITS = EV (%), UCUM, "Percent") Value = 0 – 100
13	>	HAS PROPERTIES	TEXT	EV (111058, DCM, "Selected Region Description")	1	MC	Shall be present IFF value of row 1 is (111099, DCM, "Selected region")	
14	>	HAS PROPERTIES	INCLUDE	DTID (4107) Chest CAD Geometry	1	MC	Shall be present unless value of row 1 is (111101, DCM, "Image quality")	
15	>	HAS PROPERTIES	INCLUDE	DTID (1400) Linear Measurement	1-n	U		
16	>	HAS PROPERTIES	INCLUDE	DTID (1401) Area Measurement	1-n	U		
17	>	HAS PROPERTIES	INCLUDE	DTID (1402) Volume Measurement	1-n	U		
18	>	HAS PROPERTIES	INCLUDE	DTID (4105) Chest CAD Descriptors	1	U		
19	>	INFERRED FROM	IMAGE		1	MC	Shall be present IFF value of row 1 is (111101, DCM, "Image	



NL	Rel with Parent	VT	Concept Name	VM	Req Type	Condition	Value Set Constraint
	FROM					quality”) and rows 20 and 21 are not present	
20>	R-INFERRED FROM	IMAGE		1	MC	Shall be present IFF value of row 1 is (111101, DCM, “Image quality”) and rows 19 and 21 are not present	Shall reference an IMAGE content item in the (111028, DCM, “Image Library”)
21>	INFERRED FROM	SCOORD	EV (111030, DCM, “Image Region”)	1-n	MC	Shall be present IFF value of row 1 is (111101, DCM, “Image quality”) and rows 19 and 20 are not present	
22>>	SELECTED FROM	IMAGE		1	MC	XOR row 23	All the row 21 content items in a single invocation of this template shall reference the same IMAGE
23>>	R-SELECTED FROM	IMAGE		1	MC	XOR row 22	All the row 21 content items in a single invocation of this template shall reference the same IMAGE content item in the (111028, DCM, “Image Library”)
24>	HAS PROPERTIES	INCLUDE	DTID (4014) CAD Image Quality	1	MC	Shall be present IFF value of row 1 is (111101, DCM, “Image quality”)	\$QualityFinding = DCID (6135) Chest Image Quality Finding \$QualityStandard = DCID (6136) Chest Types of Quality Control Standard

### Content Item Descriptions

Anatomic Identifier	An identifier of an anatomic feature when a multiplicity of features of that type may be present, such as “Rib 1”, “Rib 2” or thoracic vertebrae “T1” or “T2”.
Rendering Intent	This content item constrains the SCP receiving the Chest CAD SR IOD in its use of the contents of this template and its target content items. Chest CAD devices may opt to use data marked “Not for Presentation” or “Presentation Optional” as input to subsequent chest CAD processing steps. Refer to PS 3.4 section on Structured Reporting Storage SOP Classes for SCU and SCP Behavior.
CAD Operating Point	Additional information to use when Rendering Intent is “Presentation Optional”. A CAD Operating Point of zero is not sent, and is encoded as a Rendering Intent of “Presentation Required”. See PS 3.4 section on Structured Reporting Storage SOP Classes for SCU and SCP Behavior and PS 3.17 annex on Mammography.
Certainty of Finding	The certainty of the CAD device that the finding detected and classified by the Single Image Finding CODE specified is in fact that type of finding.

**TID 4105 Chest CAD Descriptors**

This template provides qualitative detail for a Single Image Finding or Composite Feature. It is applied to Chest CAD Composite Feature (TID 4102) and Chest CAD Single Image Finding (TID 4104).

**TID 4105  
CHEST CAD DESCRIPTORS  
Type: Non-Extensible**

NL	Rel with Parent	VT	Concept Name	VM	Req Type	Condition	Value Set Constraint
1		CODE	EV (112025, DCM, "Size Descriptor")	1	U		DCID (6118) Size Descriptor
2		CODE	EV (112026, DCM, "Width Descriptor")	1	U		DCID (6107) Width Descriptor
3		CODE	EV (112015, DCM, "Border shape")	1	U		DCID (6119) Chest Border Shape
4		CODE	EV (112007, DCM, "Border definition")	1	U		DCID (6120) Chest Border Definition
5		CODE	EV (112014, DCM, "Orientation Descriptor")	1	U		DCID (6121) Chest Orientation Descriptor
6		CODE	EV (112009, DCM, "Type of Content")	1-n	U		DCID (6122) Chest Content Descriptor
7		CODE	EV (112027, DCM, "Opacity Descriptor")	1	U		DCID (6123) Chest Opacity Descriptor
8		CODE	EV (112013, DCM, "Location in Chest")	1	U		DCID (6124) Location in Chest
9		CODE	EV (G-C171, SRT, "Laterality")	1	U		DCID (244) Laterality
10		CODE	EV (112006, DCM, "Distribution Descriptor")	1-n	U		DCID (6128) Chest Distribution Descriptor
11		CODE	EV (112028, DCM, "Abnormal Distribution of Anatomic Structure")	1	U		DCID (6108) Chest Anatomic Structure Abnormal Distribution
12		CODE	EV (112008, DCM, "Site involvement")	1-n	U		DCID (6129) Chest Site Involvement
13		CODE	EV (G-C197, SRT, "Severity")	1	U		DCID (6130) Severity Descriptor
14		CODE	EV (112010, DCM, "Texture Descriptor")	1	U		DCID (6131) Chest Texture Descriptor
15		CODE	EV (112030, DCM, "Calcification Descriptor")	1	U		DCID (6132) Chest Calcification Descriptor
16		NUM	DCID (6142) Calculated Value	1-n	U		
17>	HAS CONCEPT MOD	CODE	EV (121401, DCM, "Derivation")	1	M		DCID (6140) Calculation Methods
18>	INFERRED FROM	NUM	EV (112032, DCM, "Threshold Attenuation Coefficient")	1	U		UNITS = EV ([hnsfU], UCUM, "Hounsfield unit")
19>	INFERRED FROM	TEXT	EV (112034, DCM, "Calculation Description")	1	U		
20		NUM	DCID (6141) Attenuation Coefficient Measurements	1-n	U		UNITS = EV ([hnsfU], UCUM, "Hounsfield unit")

**TID 4106 Response Evaluation**

This template provides a means to report response evaluation to cancer treatment, based on a method such as RECIST or WHO.

**TID 4106**  
**RESPONSE EVALUATION**  
**Type: Non-Extensible**

NL	Rel with Parent	VT	Concept Name	VM	Req Type	Condition	Value Set Constraint
1		CONTAINER	EV (112020, DCM, "Response Evaluation")	1	M		
2	> HAS OBS CONTEXT	CODE	EV (112021, DCM, "Response Evaluation Method")	1	M		DT (112022, DCM "RECIIST") or DT (112029, DCM, "WHO")
3	> CONTAINS	CODE	EV (112048, DCM, "Current Response")	1	U		DCID (6143) Response Criteria
4	> CONTAINS	CODE	EV (112049, DCM, "Best Overall Response")	1	U		DCID (6143) Response Criteria
5	> CONTAINS	NUM	EV (112051, DCM, "Measurement of Response")	1	U		UNITS not specified

**TID 4107 Chest CAD Geometry Template**

All geometry template invocations require specification of either the location of the center of the object, the outline, or both. Geometry is a property of single image findings (see TID 4104) and composite features (see TID 4103).

**TID 4107**  
**CHEST CAD GEOMETRY**  
**Type: Non-Extensible**

NL	Rel with Parent	VT	Concept Name	VM	Req Type	Condition	Value Set Constraint
1		SCoord	EV (111010, DCM, "Center")	1	MC	At least one of rows 1,4 shall be present.	GRAPHIC TYPE = {POINT}
2	> SELECTED FROM	IMAGE		1	MC	XOR row 3	
3	> R-SELECTED FROM	IMAGE		1	MC	XOR row 2	Shall reference an IMAGE content item in the (111028, DCM, "Image Library")
4		SCoord	EV (111041, DCM, "Outline")	1	MC	At least one of rows 1,4 shall be present.	
5	> SELECTED FROM	IMAGE		1	MC	XOR row 6	Shall reference the same content item as row 2
6	> R-SELECTED FROM	IMAGE		1	MC	XOR row 5	Shall reference the same content item as row 3

**TID 4108 Tracking Identifier**

This template provides a means to identify an object for longitudinal tracking, potentially across multiple Structured Reports, over time.

**TID 4108  
TRACKING IDENTIFIER  
Type: Non-Extensible**

	NL	Rel with Parent	VT	Concept Name	VM	Req Type	Condition	Value Set Constraint
1			TEXT	EV (112039, DCM, "Tracking Identifier")	1	MC	At least one of row 1 or 2 shall be present.	A string of characters with case being non-significant. Leading and trailing spaces and control characters are forbidden.
2			UIDREF	EV (112040, DCM, "Tracking Unique Identifier")	1	MC	At least one of row 1 or 2 shall be present.	

**Content Item Descriptions**

Tracking Identifier	A human readable identifier for longitudinal tracking, e.g., "Watchlist Nodule 1".
---------------------	--

## BREAST IMAGING REPORT TEMPLATES

The templates that comprise the Breast Imaging Report are interconnected as in Figure A-10:

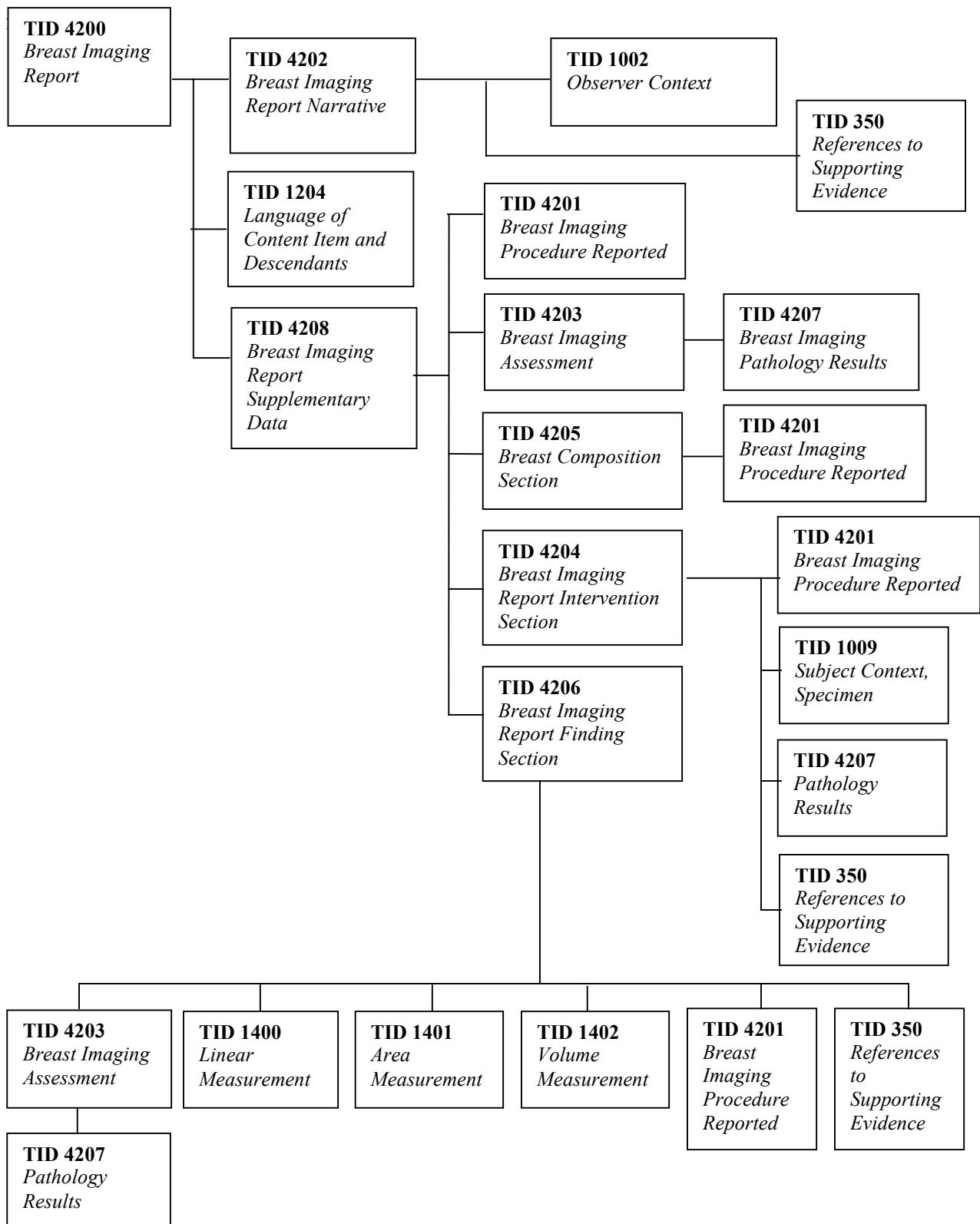

Figure A-10: Breast Imaging Report Template Structure

**TID 4200 Breast Imaging Report**

This template forms the content tree that allows a Breast Imaging Report device to describe the results of a radiologist’s diagnostic interpretation of Breast Imaging (e.g., X-ray mammography or breast ultrasound) evidence. This template, together with its subordinate templates, describes the results for presentation to clinicians, or for consumption by Breast Imaging Report devices for subsequent Breast Imaging Reports.

This template shall be instantiated at the Root node only.

See the figure entitled “Top Levels of Breast Imaging Report Content Tree” in the “Breast Imaging Report Content Tree Structure” Annex of PS 3.17.

**TID 4200  
BREAST IMAGING REPORT**

**Type: Non-Extensible**

	NL	Rel with Parent	VT	Concept Name	VM	Req Type	Condition	Value Set Constraint
1			CONTAINER	EV (111400, DCM, "Breast Imaging Report")	1	M		
2	>	HAS CONCEPT MOD	INCLUDE	DTID (1204) Language of Content Item and Descendants	1	M		
3	>	CONTAINS	INCLUDE	DTID (4202) Breast Imaging Report Narrative	1	M		
4	>	CONTAINS	INCLUDE	DTID (4208) Breast Imaging Report Supplementary Data	1	U		

**TID 4201 Breast Imaging Procedure Reported**

A procedure that is reported in a Breast Imaging Report is expressed in this template. The results of more than one procedure may be included in a single report instance (see TID 4208).

See the figure entitled “Breast Imaging Procedure Reported Content Tree” in the “Breast Imaging Report Content Tree Structure” Annex of PS 3.17.

**TID 4201  
BREAST IMAGING PROCEDURE REPORTED**

**Type: Non-Extensible**

	NL	Rel with Parent	VT	Concept Name	VM	Req Type	Condition	Value Set Constraint
1			CODE	EV (121058, DCM, "Procedure reported")	1	M		DCID (6050) Breast Procedure Reported
2	>	HAS CONCEPT MOD	CODE	EV (111464, DCM, "Procedure Modifier")	1-n	U		DCID (6058) Procedure Modifiers for Breast
3	>	HAS CONCEPT MOD	CODE	EV (G-C171, SRT, "Laterality")	1	M		DCID (6022) Side
4	>	HAS PROPERTIES	CODE	EV (111401, DCM, "Reason for procedure")	1	U		DCID (6051) Breast Procedure Reason
5	>>	HAS CONCEPT MOD	CODE	EV (G-D709, SRT, "Relative time")	1	U		DCID (12102) Temporal Periods Relating To Procedure or Therapy
6	>>	HAS CONCEPT MOD	CODE	EV (111402, DCM, "Clinical Finding")	1-n	UC	IFF row 4 value is "Clinical Finding"	DCID (6055) Breast Clinical Finding or Indicated Problem
7	>>>	HAS PROPERTIES	CODE	EV (G-C171, SRT, "Laterality")	1	U		DCID (6022) Side
8	>	HAS PROPERTIES	DATE	EV (111060, DCM, "Study Date")	1	U		

**Content Item Descriptions**

Row 5 “Relative time”	This content item indicates whether the value of “Reason for procedure” (row 4) is modified with “pre-“ or “follow-up”.
-----------------------	---

**TID 4202 Breast Imaging Report Narrative**

This template contains the narrative text sub-tree of the content tree of a Breast Imaging Report. The narrative summary may be subdivided into sections with section headings.

See the figure entitled "Breast Imaging Report Narrative Content Tree" in the "Breast Imaging Report Content Tree Structure" Annex of PS 3.17.

**TID 4202  
BREAST IMAGING REPORT NARRATIVE**

**Type: Non-Extensible**

	NL	Rel with Parent	VT	Concept Name	VM	Req Type	Condition	Value Set Constraint
1			CONTAINER	EV (111412, DCM, "Narrative Summary")	1	M		
2	>	CONTAINS	CONTAINER	BCID (6052) Breast Imaging Report Section Title	1-n	M		
3	>>	HAS OBS CONTEXT	INCLUDE	DTID (1002) Observer Context	1-n	U		
4	>>	CONTAINS	TEXT	BCID (6053) Breast Imaging Report Elements	1	M		
5	>>>	INFERRED FROM	INCLUDE	DTID (350) References to Supporting Evidence	1	U		



**TID 4203 Breast Imaging Assessment**

This template provides the content of a Breast Imaging Assessment, for an overall assessment section for the entire report (see TID 4208) or an assessment of a particular finding (see TID 4206). This template defines a code-based assessment of the interpretation results.

See the figure entitled "Breast Imaging Assessment Content Tree" in the "Breast Imaging Report Content Tree Structure" Annex of PS 3.17.

**TID 4203  
BREAST IMAGING ASSESSMENT**

**Type: Non-Extensible**

	NL	Rel with Parent	VT	Concept Name	VM	Req Type	Condition	Value Set Constraint
1			CODE	EV (111005, DCM, "Assessment Category")	1	M		DCID (6026) Mammography Assessment
2			CODE	EV (111053, DCM, "Recommended Follow-up")	1-n	U		BCID (6028) Mammography Recommended Follow-up
3	>	HAS CONCEPT MOD	CODE	EV (G-C171, SRT, "Laterality")	1	U		DCID (6022) Side
4	>	HAS PROPERTIES	NUM	EV (111055, DCM, "Recommended Follow-up Interval")	1	U		UNITS = DCID (6046) Units of Follow-up Interval Values = Integer ≥ 0, where 0 = immediate follow-up
5	>	HAS PROPERTIES	DATE	EV (111054, DCM, "Recommended Follow-up Date")	1	U		
6	>	HAS PROPERTIES	INCLUDE	DTID (4207) Breast Imaging Pathology Results	1-n	U		

**TID 4204 Breast Imaging Report Intervention Section**

This template defines a supplementary data section for an Intervention of the breast, for the Breast Imaging Report. It is included from TID 4208, Breast Imaging Report Supplementary Data.

**TID 4204  
BREAST IMAGING REPORT INTERVENTION SECTION**

**Type: Extensible**

	NL	Rel with Parent	VT	Concept Name	VM	Req Type	Condition	Value Set Constraint
1			CONTAINER	EV (111463, DCM, "Supplementary Data for Intervention")	1	M		
2	>	CONTAINS	INCLUDE	DTID (4201) Breast Imaging Procedure Reported	1	M		
3	>	CONTAINS	CODE	EV (A-00110, SRT, "Instrument")	1	U		
4	>>	HAS PROPERTIES	TEXT	EV (111465, DCM, "Needle Gauge")	1	UC	XOR row 5	
5	>>	HAS PROPERTIES	CODE	EV (111465, DCM, "Needle Gauge")	1	UC	XOR row 4	
6	>>	HAS PROPERTIES	NUM	EV (111467, DCM, "Needle Length")	1	U		UNITS = EV (cm, UCUM, "centimeter")
7	>	CONTAINS	NUM	EV (111436, DCM, "Number of passes")	1	U		UNITS = EV ({passes}, UCUM, "passes")
8	>	CONTAINS	NUM	EV (111437, DCM, "Number of specimens")	1	U		UNITS = EV ({specimens}, UCUM, "specimens")
9	>	CONTAINS	CODE	EV (111431, DCM, "Instrument Approach")	1-n	U		DCID (6065) Instrument Approach
10	>	CONTAINS	CODE	EV (111438, DCM, "Needle in target")	1	U		DCID (230) Yes-No
11	>	CONTAINS	NUM	EV (111439, DCM, "Number of needles around target")	1	U		UNITS = EV ({needles}, UCUM, "needles")
12	>	CONTAINS	CODE	EV (F-04460 SRT, "Medication given")	1-n	U		
13	>	CONTAINS	CODE	EV (111440, DCM, "Incision made")	1	U		DCID (230) Yes-No
14	>	CONTAINS	CODE	EV (111441, DCM, "Microclip placed")	1	U		DCID (230) Yes-No
15	>	CONTAINS	CODE	EV (111442, DCM, "Confirmation of target")	1	U		DCID (6066) Target Confirmation
16	>	CONTAINS	CODE	EV (DD-60002, SRT, "Complication of procedure")	1-n	U		DCID (6062) Interventional Procedure Complications
17	>>	HAS PROPERTIES	CODE	EV (111466, DCM, "Severity	1	U		DCID (251) Severity of Complication

	NL	Rel with Parent	VT	Concept Name	VM	Req Type	Condition	Value Set Constraint
				of Complication")				
18	>	CONTAINS	CONTAINER	EV (121027, DCM, "Specimen")	1-n	U		
19	>>	HAS OBS CONTEXT	INCLUDE	DTID (1009) Subject Context, Specimen	1	U		
20	>>	CONTAINS	CODE	EV (F-00E6D, SRT, "Color of fluid")	1	U		DCID (6067) Fluid Color
21	>>	CONTAINS	CODE	EV (111456, DCM, "Action on fluid")	1	U		DT (111457, DCM, "Sent for analysis") or DT (111458, DCM, "Discarded")
22	>>	CONTAINS	CODE	EV (111455, DCM, "Occult blood test result")	1	U		DCID (250) Positive-Negative
23	>>	CONTAINS	INCLUDE	DTID (4207) Breast Imaging Pathology Results	1-n	U		
24	>	CONTAINS	INCLUDE	DTID (350) References to Supporting Evidence	1	U		

**TID 4205 Breast Composition Section**

This template defines a Breast Composition section for the supplementary data sub-tree of the Breast Imaging Report. It is included from TID 4208, Breast Imaging Report Supplementary Data.

**TID 4205  
BREAST COMPOSITION SECTION**

**Type: Non-Extensible**

	NL	Rel with Parent	VT	Concept Name	VM	Req Type	Condition	Value Set Constraint
1			CONTAINER	EV (F-01710, SRT, "Breast composition")	1	M		
2	>	CONTAINS	INCLUDE	DTID (4201) Breast Imaging Procedure Reported	1-n	U		
3	>	CONTAINS	CODE	EV (F-01710, SRT, "Breast composition")	1-n	MC	At least one of row 3, 5 shall be present	DCID (6000) Overall Breast Composition
4	>>	HAS CONCEPT MOD	CODE	EV (G-C171, SRT, "Laterality")	1	M		DCID (6022) Side
5	>	CONTAINS	NUM	EV (111046, DCM, "Percent Glandular Tissue")	1-n	MC	At least one of row 3, 5 shall be present	UNITS = (%), UCUM "Percent")
6	>>	HAS CONCEPT MOD	CODE	EV (G-C171, SRT, "Laterality")	1	M		DCID (6022) Side
7	>	CONTAINS	CODE	EV (111350, DCM, "Breast background echotexture")	1-2	U		DCID (6151) Background echotexture
8	>>	HAS CONCEPT MOD	CODE	EV (G-C171, SRT, "Laterality")	1	M		DCID (6022) Side

**TID 4206 Breast Imaging Report Finding Section**

This template defines a supplementary data section for the Findings of the Breast Imaging Report. It is included from TID 4208, Breast Imaging Report Supplementary Data.

**TID 4206  
BREAST IMAGING REPORT FINDING SECTION**

**Type: Extensible**

	NL	Rel with Parent	VT	Concept Name	VM	Req Type	Condition	Value Set Constraint
1			CONTAINER	EV (121070, DCM, "Findings")	1	M		
2	>	HAS OBS CONTEXT	INCLUDE	DTID (1002) Observer Context	1-n	U		
3	>	CONTAINS	INCLUDE	DTID (4201) Breast Imaging Procedure Reported	1	M		
4	>	CONTAINS	CODE	EV (121071, DCM, "Finding")	1-n	M		DCID (6054) Breast Imaging Findings
5	>>	HAS CONCEPT MOD	CODE	EV (111405, DCM, "Implant type")	1-n	UC	May be present if value of row 4 is (A-04010, SRT, "Implant")	DCID (6059) Breast Implant Types
6	>>	HAS PROPERTIES	INCLUDE	DTID (4203) Breast Imaging Assessment	1	U		
7	>>	HAS PROPERTIES	CODE	EV (111014, DCM, "Clockface or region")	1	U		DCID (6018) Clockface Location or Region
8	>>	HAS PROPERTIES	CODE	EV (111048, DCM, "Quadrant location")	1	U		DCID (6020) Quadrant Location
9	>>	HAS PROPERTIES	INCLUDE	DTID (1400) Linear Measurement	1-n	U		
10	>>	HAS PROPERTIES	INCLUDE	DTID (1401) Area Measurement	1-n	U		
11	>>	HAS PROPERTIES	INCLUDE	DTID (1402) Volume Measurement	1-n	U		
12	>>	HAS PROPERTIES	CODE	EV (111020, DCM, "Depth")	1	U		DCID (6024) Depth
13	>>	HAS PROPERTIES	CODE	EV (111035, DCM, "Lesion Density")	1	U		DCID (6008) Density Modifier
14	>>	HAS PROPERTIES	CODE	EV (M-020F9, SRT, "Shape")	1-n	U		DCID (6004) Mammography Characteristics of Shape
15	>>	HAS PROPERTIES	CODE	EV (111037, DCM, "Margins")	1-n	U		DCID (6006) Mammography Characteristics of Margin
16	>>	HAS PROPERTIES	CODE	EV (111009, DCM, "Calcification Type")	1-n	U		DCID (6010) Mammography Calcification Types
17	>>	HAS PROPERTIES	CODE	EV (111008, DCM, "Calcification Distribution")	1	U		DCID (6012) Calcification Distribution Modifier
18	>>	HAS PROPERTIES	NUM	EV (111038, DCM, "Number of calcifications")	1	U		UNITS = EV ({calcifications}, UCUM, "calcifications")

	NL	Rel with Parent	VT	Concept Name	VM	Req Type	Condition	Value Set Constraint
								Value = Integer 1 – n
19	>>	HAS PROPERTIES	CODE	EV (111407, DCM, "Implant finding")	1-n	U		DCID (6072) Breast Implant Findings
20	>>	HAS PROPERTIES	CODE	EV (G-C189, SRT, "Associated Finding")	1-n	U		DCID (6056) Associated Findings for Breast
21	>>	HAS PROPERTIES	NUM	EV (111406, DCM, "Number of similar findings")	1	U		UNITS = EV ({findings}, UCUM, "findings") Value = Integer 2 – n
22	>>	HAS PROPERTIES	CODE	EV (F-01720, SRT, "Change since last mammogram")	1-n	U		DCID (6002) Change Since Last Mammogram or Prior Surgery
23	>>	HAS PROPERTIES	CODE	EV (111354, DCM, "Orientation")	1	U		DCID (6152) Orientation
24	>>	HAS PROPERTIES	CODE	EV (111357, DCM, "Lesion boundary")	1	U		DCID (6153) Lesion boundary
25	>>	HAS PROPERTIES	CODE	EV (111360, DCM, "Echo pattern")	1	U		DCID (6154) Echo pattern
26	>>	HAS PROPERTIES	CODE	EV (111366, DCM, "Posterior acoustic features")	1	U		DCID (6155) Posterior acoustic features
27	>>	HAS PROPERTIES	CODE	EV (111371, DCM, "Identifiable effect on surrounding tissues")	1	U		DCID (6015) Single Image Finding from BI-RADS®
28	>>	HAS PROPERTIES	CODE	EV (111372, DCM, "Vascularity")	1	U		DCID (6157) Vascularity
29	>>	HAS PROPERTIES	CODE	EV (111380, DCM, "Correlation to Other Findings")	1-n	U		DCID (6158) Correlation to Other Findings
30	>>	INFERRED FROM	INCLUDE	DTID (350) References to Supporting Evidence	1	U		

**TID 4207 Breast Imaging Pathology Results**

This template defines the pathology results for a procedure. It may be applied to a Breast Imaging Assessment (see TID 4203), or a Breast Imaging Intervention (see TID 4204).

**TID 4207  
BREAST IMAGING PATHOLOGY RESULTS**

**Type: Extensible**

	NL	Rel with Parent	VT	Concept Name	VM	Req Type	Condition	Value Set Constraint
1			CONTAINER	EV (111468, DCM, "Pathology Results")	1	M		
2	>	CONTAINS	INCLUDE	DTID (4201) Breast Imaging Procedure Reported	1	U		
3	>	CONTAINS	DATETIME	EV (111469, DCM, "Sampling Datetime")	1	M		
4	>	CONTAINS	CODE	EV (122177, DCM, "Procedure Result")	1	M		DCID (6063) Interventional Procedure Results
5	>	CONTAINS	CODE	EV (111042, DCM, "Pathology")	1-n	U		BCID (6030) Mammography Pathology Codes
6	>>	HAS PROPERTIES	CODE	EV (111388, DCM, "Malignancy Type")	1	U		DCID (6159) Malignancy Type
7	>>	HAS PROPERTIES	NUM	DCID (6165) Breast Linear Measurements	1-n	U		UNITS = EV (mm, UCUM, "millimeter")
8	>>	HAS PROPERTIES	CODE	EV (F-02900, SRT, "Histological grade finding")	1	U		BCID (6069) Nottingham Combined Histologic Grade, BCID (6070) Bloom-Richardson Histologic Grade
9	>>>	HAS CONCEPT MOD	CODE	EV (R-00258, SRT, "Histologic grade")	1	U		BCID (6071) Histologic Grading Method
10	>>	HAS PROPERTIES	CODE	EV (R-00274, SRT, "Tumor margin status")	1	U		DT (114470, DCM, "Uninvolved"), DT (114471, DCM, "Involved")
11	>>	HAS PROPERTIES	CODE	EV (111472, DCM, "Nipple involved")	1	U		DCID (230) Yes-No
12	>>	HAS PROPERTIES	NUM	EV (111473, DCM, "Number of nodes removed")	1	U		UNITS=EV ({nodes}, UCUM, "nodes")
13	>>	HAS PROPERTIES	NUM	EV (111474, DCM, "Number of nodes positive")	1	MC	Shall be present IFF value of row 12 is > 0	UNITS=EV ({nodes}, UCUM, "nodes")
14	>>	HAS PROPERTIES	CODE	EV (R-00465, SRT, "pT category finding")	1	U		DCID (6160) Breast Primary Tumor Assessment from AJCC
15	>>	HAS PROPERTIES	CODE	EV (R-00463, SRT, "Node stage finding")	1	U		DCID (6161) Clinical Regional Lymph Node Assessment for Breast
16	>>	HAS PROPERTIES	CODE	EV (R-00461, SRT, "Metastasis	1	U		DCID (6162) Assessment of Metastasis for Breast

	NL	Rel with Parent	VT	Concept Name	VM	Req Type	Condition	Value Set Constraint
				stage finding")				
17	>>	HAS PROPERTIES	CODE	EV (R-00443, SRT, "Tumor stage finding")	1	U		BCID (6068) Tumor Stages from AJCC
18	>>	HAS PROPERTIES	CODE	EV (111475, DCM, "Estrogen receptor")	1	U		DCID (250) Positive-Negative
19	>>	HAS PROPERTIES	CODE	EV (111476, DCM, "Progesterone receptor")	1	U		DCID (250) Positive-Negative
20	>>	HAS PROPERTIES	NUM	EV (111477, DCM, "S Phase")	1	U		UNITS=EV (% , UCUM, "percent")

**TID 4208 Breast Imaging Report Supplementary Data**

This template forms a supplementary data sub-tree of the content tree of a Breast Imaging Report. Each subsection provides a specific type of supporting evidence to the narrative text sub-tree, for example, as coded and numeric data.

See the figure entitled "Breast Imaging Report Supplementary Data Content Tree" in the "Breast Imaging Report Content Tree Structure" Annex of PS 3.17.

**TID 4208  
BREAST IMAGING REPORT SUPPLEMENTARY DATA**

**Type: Non-Extensible**

	NL	Rel with Parent	VT	Concept Name	VM	Req Type	Condition	Value Set Constraint
1			CONTAINER	EV (111414, DCM, "Supplementary Data")	1	M		
2	>	CONTAINS	INCLUDE	DTID (4201) Breast Imaging Procedure Reported	1-n	M		
3	>	CONTAINS	CODE	EV (111403, DCM, "Baseline screening mammogram")	1	U		DCID (230) Yes-No
4	>	CONTAINS	CODE	EV (111404, DCM, "First mammogram ever")	1	U		DCID (230) Yes-No
5	>	CONTAINS	INCLUDE	DTID (4205) Breast Composition Section	1	U		
6	>	CONTAINS	INCLUDE	DTID (4206) Breast Imaging Report Finding Section	1-n	U		
7	>	CONTAINS	INCLUDE	DTID (4204) Breast Imaging Report Intervention Section	1-n	U		
8	>	CONTAINS	CONTAINER	EV (111413, DCM, "Overall Assessment")	1	U		
9	>>	CONTAINS	INCLUDE	DTID (4203) Breast Imaging Assessment	1	M		



**OB-GYN REPORT TEMPLATES**

**TID 5000 OB-GYN Ultrasound Procedure Report**

This is the template for the root of the content tree for the OB-GYN ultrasound procedure report.

**TID 5000  
OB-GYN Ultrasound Procedure Report  
Type: Extensible**

NL	Rel with Parent	VT	Concept Name	VM	Req Type	Condition	Value Set Constraint
1		CONTAINER	EV (125000, DCM, "OB-GYN Ultrasound Procedure Report")	1	M		
2	>	HAS CONCEPT MOD	INCLUDE DTID (1204) Language of Content Item and Descendants	1	U		
3	>	HAS OBS CONTEXT	INCLUDE DTID (1001) Observation Context	1	M		
4	>	CONTAINS	INCLUDE DTID (5001) Patient Characteristics	1	U		
5	>	CONTAINS	CONTAINER DT (111028, DCM, "Image Library")	1	U		
6	>>	CONTAINS	IMAGE No purpose of reference	1-n	M		
7	>	CONTAINS	INCLUDE DTID (5002) OB-GYN Procedure Summary Section	1	U		
8	>	CONTAINS	INCLUDE DTID (5004) Fetal Biometry Ratio Section	1-n	U		
9	>	CONTAINS	INCLUDE DTID (5005) Fetal Biometry Section	1-n	U		
10	>	CONTAINS	INCLUDE DTID (5006) Long Bones Section	1-n	U		
11	>	CONTAINS	INCLUDE DTID (5007) Fetal Cranium Section	1-n	U		
12	>	CONTAINS	INCLUDE DTID (5009) Fetal Biophysical Profile Section	1-n	U		
13	>	CONTAINS	INCLUDE DTID (5011) Early Gestation Section	1-n	U		
14	>	CONTAINS	INCLUDE DTID (5010) Amniotic Sac Section	1	U		
15	>	CONTAINS	INCLUDE DTID (5015) Pelvis and Uterus Section	1	U		
16	>	CONTAINS	INCLUDE DTID (5012) Ovaries Section	1	U		
17	>	CONTAINS	INCLUDE DTID (5013) Follicles Section	1	U		\$Laterality = EV (G-A101, SRT, "Left") \$Number = EV (11879-4, LN, "Number of follicles in left ovary")
18	>	CONTAINS	INCLUDE DTID (5013) Follicles Section	1	U		\$Laterality = EV (G-A100, SRT, "Right") \$Number = EV (11880-2, LN, "Number of follicles in right ovary")
19	>	CONTAINS	CONTAINER EV (121070, DCM, "Findings")	1-n	U		
20	>>	HAS CONCEPT MOD	CODE EV (G-C0E3, SRT, "Finding Slte")	1	M		EV (T-F6800, SRT, "Embryonic Vascular Structure")
21	>>	CONTAINS	INCLUDE DTID (5025) OB-GYN Fetal Vascular Measurement Group	1	M		\$AnatomyGroup = DCID (12141) Fetal Vasculature
22	>	CONTAINS	CONTAINER EV (121070, DCM, "Findings")	1	U		
23	>>	HAS CONCEPT MOD	CODE EV (G-C0E3, SRT, "Finding Slte")	1	M		EV (T-D6007, SRT, "Pelvic Vascular Structure")
24	>>	CONTAINS	INCLUDE DTID (5026) OB-GYN Pelvic Vascular Measurement Group	1	M		\$AnatomyGroup = DCID (12140) Pelvic Vasculature Anatomical Location

**TID 5001 OB-GYN Patient Characteristics**

Patient Characteristic concepts in this template, which may replicate attributes in the Patient Study Module, are included here as possible targets of by-reference relationships from other content items in the SR tree.

Note: Several of the concepts in this template duplicate concepts in TID 1007 "Subject Context, Patient". The difference in use is that this template has those concepts as primary observations of the patient, while in TID 1007 the concepts are used to set (or reset) the context for other observations.

**TID 5001  
OB-GYN PATIENT CHARACTERISTICS  
Type: Extensible**

NL	Rel with Parent	VT	Concept Name	VM	Req Type	Condition	Value Set Constraint
1		CONTAINER	EV (121118, DCM, "Patient Characteristics")	1	M		
2	>	CONTAINS	TEXT	EV (121106, DCM, "Comment")	1	U	
3	>	CONTAINS	NUM	EV (8302-2, LN, "Patient Height")	1	U	
4	>	CONTAINS	NUM	EV (29463-7, LN, "Patient Weight")	1	U	
5	>	CONTAINS	NUM	EV (11996-6, LN, "Gravida")	1	U	
6	>	CONTAINS	NUM	EV (11977-6, LN, "Para")	1	U	
7	>	CONTAINS	NUM	EV (11612-9, LN, "Aborta")	1	U	
8	>	CONTAINS	NUM	EV (33065-4, LN, "Ectopic Pregnancies")	1	U	

**TID 5002 OB-GYN Procedure Summary Section**

Observations of the procedure of immediate clinical interest.

**TID 5002  
OB-GYN PROCEDURE SUMMARY SECTION  
Type: Extensible**

NL	Rel with Parent	VT	Concept Name	VM	Req Type	Condition	Value Set Constraint
1		CONTAINER	DT (121111, DCM, "Summary")	1	M		
2	>	CONTAINS	DATE	DCID (12003) OB-GYN Dates	1-n	U	
3	>	CONTAINS	INCLUDE	DTID (300) Measurement	1-n	U	\$Measurement = BCID (12018) OB-GYN Summary
4	>	CONTAINS	TEXT	EV (121106, DCM, "Comment")	1-n	U	
5	>>		INCLUDE	DTID (320) Image or Spatial Coordinates	1-n	U	
6	>	CONTAINS	INCLUDE	BTID (5003) OB-GYN Fetus Summary	1-n	UC	No more than 1 inclusion per fetus

**TID 5003 OB-GYN Fetus Summary**

The Fetus Summary template is a container for summary data of a fetus.

**TID 5003**  
**OB-GYN PROCEDURE FETUS SUMMARY**  
Type: Extensible

NL	Rel with Parent	VT	Concept Name	VM	Req Type	Condition	Value Set Constraint
1		CONTAINER	DT (125008, DCM, "Fetus Summary")	1	M		
2	>	HAS OBS CONTEXT	INCLUDE	DTID (1008) Subject Context, Fetus	1	MC	IF this template is invoked more than once to describe more than one fetus
3	>	CONTAINS	TEXT	EV (121106, DCM, "Comment")	1-n	U	
4	>>		INCLUDE	DTID (320) Image or Spatial Coordinates	1	U	
5	>	CONTAINS	INCLUDE	DTID (300) Measurement	1-n	U	\$Measurement = DCID (12019) OB-GYN Fetus Summary \$Equation = DCID (12012) OB Equations and Tables

**TID 5004 Fetal Biometry Ratio Section**

The Fetal Biometry Section Ratio template is a container for common biometric ratios.

**TID 5004**  
**FETAL BIOMETRY RATIO SECTION**  
Type: Extensible

NL	Rel with Parent	VT	Concept Name	VM	Req Type	Condition	Value Set Constraint
1		CONTAINER	DT (125001, DCM, "Fetal Biometry Ratios")	1	M		
2	>	HAS OBS CONTEXT	INCLUDE	DTID (1008) Subject Context, Fetus	1	MC	IF this template is invoked more than once to describe more than one fetus
3	>	CONTAINS	NUM	DCID (12004) Fetal Biometry Ratios	1-n	M	
4	>>	R-INFERRED FROM	NUM		2	U	
5	>>	HAS PROPERTIES	INCLUDE	DTID (312) Normal Range Properties	1	U	

**Content Item Descriptions**

Row 3	Numeric ratio related to fetal growth
Row 4	Reference to the numerator and denominator of the ratio.

**TID 5005 Fetal Biometry Section**

The Fetal Biometry Section template is a container for common biometric groups.

**TID 5005**  
**FETAL BIOMETRY SECTION**  
Type: Extensible

NL	Rel with Parent	VT	Concept Name	VM	Req Type	Condition	Value Set Constraint
1		CONTAINER	DT (125002, DCM, "Fetal Biometry")	1	M		

	NL	Rel with Parent	VT	Concept Name	VM	Req Type	Condition	Value Set Constraint
2	>	HAS OBS CONTEXT	INCLUDE	DTID (1008) Subject Context, Fetus	1	MC	IF this template is invoked more than once to describe more than one fetus	
3	>	CONTAINS	INCLUDE	DTID (5008) Fetal Biometry Group	1-n	M		\$BiometryType = MemberOf {DCID (12005) Fetal Biometry Measurements}

**Content Item Descriptions**

Row 3	The group of measurements. Only one group per biometry type.
-------	--

**TID 5006 Fetal Long Bones Section**

The Long Bones template is a container for biometric data of long bones.

**TID 5006  
FETAL LONG BONES SECTION  
Type: Extensible**

	NL	Rel with Parent	VT	Concept Name	VM	Req Type	Condition	Value Set Constraint
1			CONTAINER	DT (125003, DCM, "Fetal Long Bones")	1	M		
2	>	HAS OBS CONTEXT	INCLUDE	DTID (1008) Subject Context, Fetus	1	MC	IF this template is invoked more than once to describe more than one fetus	
3	>	CONTAINS	INCLUDE	DTID (5008) Fetal Biometry Group	1-n	M		\$BiometryType = MemberOf {DCID (12006) Fetal Long Bones Biometry Measurements}

**Content Item Descriptions**

Row 3	The group of measurements. Only one group per biometry type.
-------	--

**TID 5007 Fetal Cranium Section**

The Fetal Cranium template is a container for groups of biometric data of the fetal cranium.

**TID 5007  
FETAL CRANIUM SECTION  
Type: Extensible**

	NL	Rel with Parent	VT	Concept Name	VM	Req Type	Condition	Value Set Constraint
1			CONTAINER	DT (125004, DCM, "Fetal Cranium")	1	M		
2	>	HAS OBS CONTEXT	INCLUDE	DTID (1008) Subject Context, Fetus	1	MC	IF this template is invoked more than once to describe more than one fetus	
3	>	CONTAINS	INCLUDE	DTID (5008) Fetal Biometry Group	1-n	M		\$BiometryType = MemberOf {DCID (12007) Fetal Cranium}

**Content Item Descriptions**

Row 3	The group of measurements. Only one group per biometry type.
-------	--

**TID 5008 Fetal Biometry Group**

The Biometry Group template is container for a biometric value and its associated growth metrics.

**TID 5008 Parameters**

Parameter Name	Parameter Usage
\$BiometryType	The concept name of the biometry measurement

**TID 5008  
FETAL BIOMETRY GROUP  
Type: Extensible**

	NL	Relation with Parent	Value Type	Concept Name	VM	Req Type	Condition	Value Set Constraint
1			CONTAINER	DT(125005, DCM, "Biometry Group")	1	M		
2	>	CONTAINS	INCLUDE	DTID (300) Measurement	1-n	MC	At least one of row 2 and 3 shall be present	\$Measurement = \$BiometryType \$Derivation = DCID (3627) Measurement Type
3	>	CONTAINS	NUM	EV (18185-9, LN, "Gestational Age")	1	MC	At least one of row 2 and 3 shall be present	Units= EV (d,UCUM, days)
4	>>	INFERRED FROM	CODE	DCID (228) Equation or Table	1	U		DCID (12013) Gestational Age Equations and Tables
5	>>	R-INFERRED FROM	NUM		1-n	U		
6	>>	HAS PROPERTIES	NUM	DCID (226) Population Statistical Descriptors	1-n	U		
7	>	CONTAINS	NUM	DCID (12017) Growth Distribution Rank	1	U		
8	>>	INFERRED FROM	CODE	DCID (228) Equation or Table	1	U		DCID (12015) Fetal Growth Equations and Tables

**Content Item Descriptions**

Row 1	Container to segregate biometry data by measurement type
Row 2	The discrete measurements of the biometry type including derived measurements such as mean. One of the measurements may be flagged as selected for derived measurements.
Row 3	The estimated gestational age derived from an equation or table based on the explicitly referenced R-INFERRED FROM content item, selected measurement or mean, in that order of preference.
Row 4	The reference that defines the equation or table of GA derivation
Row 6	The uncertainty/confidence limits of the gestational age
Row 7	Expresses the rank of the selected or mean measurement of row 2 relative to the distribution specified in row 8.
Row 8	This row specifies the CODE reference used to compute the percentile or Z-score.

**TID 5009 Fetal Biophysical Profile Section**

This template encodes scoring observations for fetal well-being evaluation as described by Manning, Antepartum Fetal Evaluation: Development of a Fetal Biophysical Profile Score, Am. J Obstet Gynecol, 1980;136:787.

**TID 5009  
FETAL BIOPHYSICAL PROFILE SECTION**

	NL	Relation with Parent	Value Type	Concept Name	V M	Req Type	Condition	Value Set Constraint
1			CONTAINER	DT (125006, DCM, "Biophysical Profile")	1	M		
2	>	HAS OBS CONTEXT	INCLUDE	DTID (1008) Subject Context, Fetus	1	MC	IF this template is invoked more than once to describe more than one fetus	
3	>	CONTAINS	NUM	EV (11631-9, LN, "Gross Body Movement")	1	MC	At least one of row 3-7 shall be present	Units = DT ("{0:2}", UCUM, "range 0:2")
4	>	CONTAINS	NUM	EV (11632-7, LN, "Fetal Breathing")	1	MC	At least one of row 3-7 shall be present	Units = DT ("{0:2}", UCUM, "range 0:2")
5	>	CONTAINS	NUM	EV (11635-0, LN, "Fetal Tone")	1	MC	At least one of row 3-7 shall be present	Units = DT ("{0:2}", UCUM, "range 0:2")
6	>	CONTAINS	NUM	EV (11635-5, LN, "Fetal Heart Reactivity")	1	MC	At least one of row 3-7 shall be present	Units = DT ("{0:2}", UCUM, "range 0:2")
7	>	CONTAINS	NUM	EV (11630-1, LN, "Amniotic Fluid Volume")	1	MC	At least one of row 3-7 shall be present	Units = DT ("{0:2}", UCUM, "range 0:2")
8	>	CONTAINS	NUM	DT (11634-3, LN, "Biophysical Profile Sum Score")	1	U		

**Content Item Descriptions**

Row 3-7	The numeric profile score of range 0-2
Row 8	The sum of rows 3-7. The range is from 0 to the maximum possible score according the items scored in rows 3-7.

**TID 5010 Amniotic Sac Section**

This template specifies a container for amniotic sac quadrant diameters and a derived index.

**TID 5010  
AMNIOTIC SAC SECTION  
Type: Extensible**

	NL	Relation with Parent	Value Type	Concept Name	V M	Req Type	Condition	Value Set Constraint
1			CONTAINER	DT (121070, DCM, "Findings")	1	M		
2	>	HAS CONCEPT MOD	CODE	EV (G-C0E3, SRT, "Finding Site")	1	M		DT (T-F1300, SRT, "Amniotic Sac")
3	>	CONTAINS	INCLUDE	DTID (300) Measurement	1	M		\$Measurement = DT (11627-7, LN, "Amniotic Fluid Index")
4	>	CONTAINS	INCLUDE	DTID (300) Measurement	4	U		\$Measurement = DCID (12008) OB-GYN

	NL	Relation with Parent	Value Type	Concept Name	V M	Req Type	Condition	Value Set Constraint
								Amniotic Sac

**Content Item Descriptions**

Row 3	The sum of the 4 quadrant diameters
Row 4	The four amniotic sac quadrant diameters

**TID 5011 Early Gestation Section**

The Early Gestation Section template is a container for common, first trimester biometric groups.

**TID 5011  
EARLY GESTATION SECTION  
Type: Extensible**

	NL	Relation with Parent	Value Type	Concept Name	V M	Req Type	Condition	Value Set Constraint
1			CONTAINER	DT (125009, DCM, "Early Gestation")	1	M		
2	>	HAS OBS CONTEXT	INCLUDE	DTID (1008) Subject Context, Fetus	1	MC	IF this template is invoked more than once to describe more than one fetus	
3	>	CONTAINS	INCLUDE	DTID (5008) Fetal Biometry Group	1-n	M		\$BiometryType= Member of {DCID (12009) Early Gestation Biometry Measurements}

**TID 5012 Ovaries Section**

This template contains metrics of ovary size.

**TID 5012  
OVARIES SECTION  
Type: Extensible**

	NL	Relation with Parent	Value Type	Concept Name	V M	Req Type	Condition	Value Set Constraint
1			CONTAINER	DT (121070, DCM, "Findings")	1	M		
2	>	HAS CONCEPT MOD	CODE	EV (G-C0E3, SRT, "Finding Site")	1	M		DT (T-87000, SRT, "Ovary")
3	>	CONTAINS	INCLUDE	DTID (5016) LWH Volume Group	1	U		\$GroupName = EV (T-87000, SRT, "Ovary") \$Width =EV (11829-9, LN, "Left Ovary Width") \$Length =EV (11840-6, LN, "Left Ovary Length") \$Height =EV (11857-0, LN, "Left Ovary Height") \$Volume=EV (12164-0, LN, "Left Ovary Volume")
4	>	CONTAINS	INCLUDE	DTID (5016) LWH Volume Group	1	U		\$GroupName = EV (T-87000, SRT, "Ovary") \$Width = EV (11830-7, LN,

	NL	Relation with Parent	Value Type	Concept Name	V M	Req Type	Condition	Value Set Constraint
								"Right Ovary Width") \$Length = EV (11841-4, LN, "Right Ovary Length") \$Height = EV (11858-8, LN, "Right Ovary Height") \$Volume= EV (12165-7, LN, "Right Ovary Volume")

### TID 5013 Follicles Section

This template contains follicle metrics for left or right ovarian follicles.

#### TID 5013 Parameters

Parameter Name	Parameter Usage
\$Laterality	Ovary laterality
\$Number	The number of follicles

### TID 5013 FOLLICLES SECTION Type: Extensible

	NL	Relation with Parent	Value Type	Concept Name	V M	Req Type	Condition	Value Set Constraint
1			CONTAINER	DT (121070, DCM, "Findings")	1	M		
2	>	HAS CONCEPT MOD	CODE	EV (G-C0E3, SRT, "Finding Site")	1	M		DT (T-87600, SRT, "Ovarian Follicle")
3	>	HAS CONCEPT MOD	CODE	EV (G-C171, SRT, "Laterality")	1	M		\$Laterality
4	>	CONTAINS	NUM	\$Number	1	U		
5	>	CONTAINS	INCLUDE	DTID (5014) Follicle Measurement Group	1-n	U		

### TID 5014 Follicle Measurement Group

This template contains metrics for one ovarian follicle.

### TID 5014 FOLLICLE MEASUREMENT GROUP Type: Extensible

	NL	Relation with Parent	Value Type	Concept Name	V M	Req Type	Condition	Value Set Constraint
1			CONTAINER	EV (125007, DCM, "Measurement Group")	1	M		
2	>	HAS OBS CONTEXT	TEXT	EV (12510, DCM, "Identifier")	1	U		Unique among all groups of same laterality
3	>	CONTAINS	INCLUDE	DTID (300) Measurement	1	U		\$Measurement = EV (G- D705, SRT, "Volume")
4	>	CONTAINS	INCLUDE	DTID (300) Measurement	1-n	U		\$Measurement = EV (11793-7, LN, "Follicle Diameter") \$Derivation = DCID (3627) Measurement



	NL	Relation with Parent	Value Type	Concept Name	V M	Req Type	Condition	Value Set Constraint
								Type

**TID 5015 Pelvis and Uterus Section**

This template contains general measurements in the pelvis and uterus.

**TID 5015  
PELVIS AND UTERUS SECTION  
Type: Extensible**

	NL	Relation with Parent	Value Type	Concept Name	V M	Req Type	Condition	Value Set Constraint
1			CONTAINER	DT (125011, DCM, "Pelvis and Uterus")	1	M		
2	>	CONTAINS	INCLUDE	DTID (5016) LWH Volume Group	1	U		\$GroupName = EV (T-83000, SRT, "Uterus") \$Width = EV (11865-3, LN, "Uterus Width") \$Length = EV (11842-2, LN, "Uterus Length") \$Height = EV (11859-6, LN, "Uterus Height") \$Volume = EV (33192-6, LN, "Uterus Volume")
3	>	CONTAINS	INCLUDE	DTID (300) Measurement	1-n	U		\$Measurement = DCID (12011) Ultrasound Pelvis and Uterus \$Derivation = DCID (3627) Measurement Type

**TID 5016 LWH Volume Group**

This template is a container for a group of measurements that assess the size of an anatomical structure using a volume derived from perpendicular diameters.

**TID 5016 Parameters**

Parameter Name	Parameter Usage
\$GroupName	The name of the volume group
\$Volume	Concept name of volume measurement
\$Length	Concept name of length measurement
\$Width	Concept name of width measurement
\$Height	Concept name of height measurement

**TID 5016  
LWH VOLUME GROUP  
Type: Extensible**

	NL	Relation with Parent	Value Type	Concept Name	V M	Req Type	Condition	Value Set Constraint
1			CONTAINER	\$GroupName	1	M		
2	>	CONTAINS	INCLUDE	DTID (300) Measurement	1	MC	At least one of row 2,3,4,5 shall be present	\$Measurement = \$Volume
3	>	CONTAINS	INCLUDE	DTID (300) Measurement	1-n	MC	At least one of row	\$Measurement =

	NL	Relation with Parent	Value Type	Concept Name	V M	Req Type	Condition	Value Set Constraint
							2,3,4,5 shall be present	\$Length \$Derivation = DCID (3627) Measurement Type
4	>	CONTAINS	INCLUDE	DTID (300) Measurement	1-n	MC	At least one of row 2,3,4,5 shall be present	\$Measurement = \$Width \$Derivation = DCID (3627) Measurement Type
5	>	CONTAINS	INCLUDE	DTID (300) Measurement	1-n	MC	At least one of row 2,3,4,5 shall be present	\$Measurement = \$Height \$Derivation = DCID (3627) Measurement Type

### TID 5025 OB-GYN Fetal Vascular Ultrasound Measurement Group

This template is an anatomy specific container of OB-GYN fetal vascular measurements.

Parameter Name	Parameter Usage
\$AnatomyGroup	The concept name of the vascular anatomy

### TID 5025 OB-GYN FETAL VASCULAR ULTRASOUND MEASUREMENT GROUP Type: Extensible

	NL	Rel with Parent	VT	Concept Name	VM	Req Type	Condition	Value Set Constraint
1			CONTAINER	\$AnatomyGroup	1	M		
2	>	HAS OBS CONTEXT	INCLUDE	DTID (1008) Subject Context, Fetus	1	MC	IF this template is invoked more than once to describe more than one fetus	
3	>	HAS CONCEPT MOD	CODE	EV (G-C171, SRT "Laterality")	1	MC	IFF anatomy has laterality	DCID (244) Laterality
4	>	CONTAINS	INCLUDE	DTID (300) Measurement	1-n	M		\$MeasType = DCID (12119) Vascular Ultrasound Property \$Derivation = DCID (3627) Measurement Type

### Content Item Descriptions

Anatomy Group	Specifies the anatomical context of the observations in the group.
---------------	--

### TID 5026 OB-GYN Pelvic Vascular Ultrasound Measurement Group

This template is an anatomy specific container of OB-GYN pelvic vascular measurements.

Parameter Name	Parameter Usage
\$AnatomyGroup	The concept name of the vascular anatomy

### TID 5026 OB-GYN PELVIC VASCULAR ULTRASOUND MEASUREMENT GROUP Type: Extensible - Standard -

NL	Rel with Parent	VT	Concept Name	VM	Req Type	Condition	Value Set Constraint
1		CONTAINER	\$AnatomyGroup	1	M		
2	> HAS CONCEPT MOD	CODE	EV (G-C171, SRT, "Laterality")	1	MC	IFF anatomy has laterality	DCID (244) Laterality
3	> HAS CONCEPT MOD	TEXT	(112050, DCM, "Anatomic Identifier")	1	U		
4	> CONTAINS	INCLUDE	DTID (300) Measurement	1-n	M		\$MeasType = DCID (12119) Vascular Ultrasound Property \$Derivation = DCID (3627) Measurement Type

### Content Item Descriptions

Row 1	Specifies the anatomical context of the observations in the group.
Row 3	Differentiates between multiple structures such as the two umbilical arteries.

**VASCULAR ULTRASOUND REPORT TEMPLATES**

**TID 5100 Vascular Ultrasound Report**

This is the template for the root the content tree for the vascular ultrasound procedure report.

**Type: Extensible**

**TID 5100  
VASCULAR ULTRASOUND REPORT  
Type: Extensible**

NL	Rel with Parent	VT	Concept Name	VM	Req Type	Condition	Value Set Constraint
1.		CONTAINER	EV (125100, DCM, "Vascular Ultrasound Procedure Report")	1	M		
2	> HAS OBS CONTEXT	CODE	EV (R-40FB8, SRT, "Temporal periods Relating to Procedure")	1	U		DCID (12102) Temporal Periods Relating To Procedure or Therapy
3	> HAS CONCEPT MOD	INCL UDE	DTID (1204) Language of Content Item and Descendants	1	U		
4	> HAS OBS CONTEXT	INCLUDE	DTID (1001) Observation Context	1	M		
5	> CONTAINS	INCLUDE	DTID (5101) Vascular Patient Characteristics	1	U		
6	> CONTAINS	CONTAINER	EV (111028, DCM, "Image Library")	1	U		
7	>> CONTAINS	IMAGE	No purpose of reference	1-n	M		
8	> CONTAINS	INCLUDE	DTID (5102) Vascular Procedure Summary Section	1	U		
9	> CONTAINS	INCLUDE	DTID (5103) Vascular Ultrasound Section	1	U		\$SectionScope = DT (T-40501, SRT, "Blood Vessel of Head") \$SectionLaterality = EV (G-A101, SRT, "Left") \$Anatomy = DCID (12105) Intracranial Cerebral Vessels
10	> CONTAINS	INCLUDE	DTID (5103) Vascular Ultrasound Section	1	U		\$SectionScope = DT (T-40501, SRT, "Blood Vessel of Head") \$SectionLaterality = EV (G-A100, SRT, "Right") \$Anatomy = DCID (12105) Intracranial Cerebral Vessels
11	> CONTAINS	INCLUDE	DTID (5103) Vascular Ultrasound Section	1	U		\$SectionScope = DT (T-40501, SRT, "Blood Vessel of Head") \$SectionLaterality = EV (G-A103, SRT, "Unilateral") \$Anatomy = DCID (12106) Intracranial Cerebral Vessels (unilateral)
12	> CONTAINS	INCLUDE	DTID (5103) Vascular Ultrasound Section	1	U		\$SectionScope = DT (T-45005, SRT, "Artery of neck") \$SectionLaterality = EV (G-A101, SRT, "Left") \$Anatomy = DCID (12104) Extracranial Arteries \$AnatomyRatio = DCID (12123) Carotid Ratios
13	> CONTAINS	INCLUDE	DTID (5103) Vascular Ultrasound Section	1	U		\$SectionScope = DT (T-45005, SRT, "Artery of neck") \$SectionLaterality = EV (G-A100, SRT, "Right") \$Anatomy = DCID (12104) Extracranial Arteries \$AnatomyRatio = DCID (12123) Carotid Ratios
14	> CONTAINS	INCLUDE	DTID (5103) Vascular Ultrasound Section	1	U		\$SectionScope = DT (T-47040, SRT, "Artery of Lower Extremity")

NL	Rel with Parent	VT	Concept Name	VM	Req Type	Condition	Value Set Constraint
							\$SectionLaterality = EV (G-A101, SRT, "Left") \$Anatomy = DCID (12109) Lower Extremity Arteries
15>	CONTAINS	INCLUDE	DTID (5103) Vascular Ultrasound Section	1	U		\$SectionScope = DT (T-47040, SRT, "Artery of Lower Extremity") \$SectionLaterality = EV (G-A100, SRT, "Right") \$Anatomy = DCID (12109) Lower Extremity Arteries
16>	CONTAINS	INCLUDE	DTID (5103) Vascular Ultrasound Section	1	U		\$SectionScope = DT (T-49403, SRT, "Vein of Lower Extremity") \$SectionLaterality = EV (G-A101, SRT, "Left") \$Anatomy = DCID (12110) Lower Extremity Veins
17>	CONTAINS	INCLUDE	DTID (5103) Vascular Ultrasound Section	1	U		\$SectionScope = DT (T-49403, SRT, "Vein of Lower Extremity") \$SectionLaterality = EV (G-A100, SRT, "Right") \$Anatomy = DCID (12110) Lower Extremity Veins
18>	CONTAINS	INCLUDE	DTID (5103) Vascular Ultrasound Section	1	U		\$SectionScope = DT (T-47020, SRT, "Artery Of Upper Extremity") \$SectionLaterality = EV (G-A101, SRT, "Left") \$Anatomy = DCID (12107) Upper Extremity Arteries
19>	CONTAINS	INCLUDE	DTID (5103) Vascular Ultrasound Section	1	U		\$SectionScope = DT (T-47020, SRT, "Artery Of Upper Extremity") \$SectionLaterality = EV (G-A100, SRT, "Right") \$Anatomy = DCID (12107) Upper Extremity Arteries
20>	CONTAINS	INCLUDE	DTID (5103) Vascular Ultrasound Section	1	U		\$SectionScope = DT (T-49103, SRT, "Vein Of Upper Extremity") \$SectionLaterality = EV (G-A101, SRT, "Left") \$Anatomy = DCID (12108) Upper Extremity Veins
21>	CONTAINS	INCLUDE	DTID (5103) Vascular Ultrasound Section	1	U		\$SectionScope = DT (T-49103, SRT, "Vein Of Upper Extremity") \$SectionLaterality = EV (G-A100, SRT, "Right") \$Anatomy = DCID (12108) Upper Extremity Veins
22>	CONTAINS	INCLUDE	DTID (5103) Vascular Ultrasound Section	1	U		\$SectionScope = DT (T-71019, SRT, "Vascular Structure Of Kidney") \$SectionLaterality = EV (G-A101, SRT, "Left") \$Anatomy = DCID (12115) Renal Vessels \$AnatomyRatio = DCID (12124) Renal Ratios
23>	CONTAINS	INCLUDE	DTID (5103) Vascular Ultrasound Section	1	U		\$SectionScope = DT (T-71019, SRT, "Vascular Structure Of Kidney") \$SectionLaterality = EV (G-A100, SRT, "Right") \$Anatomy = DCID (12115) Renal Vessels \$AnatomyRatio = DCID (12124) Renal Ratios
24>	CONTAINS	INCLUDE	DTID (5103) Vascular Ultrasound Section	1	U		\$SectionScope = DT (T-46002, SRT, "Artery of Abdomen") \$SectionLaterality = EV (G-A101, SRT, "Left") \$Anatomy = DCID (12111) Abdominal Arteries (lateral)
25>	CONTAINS	INCLUDE	DTID (5103) Vascular Ultrasound Section	1	U		\$SectionScope = DT (T-46002, SRT, "Artery of Abdomen")

NL	Rel with Parent	VT	Concept Name	VM	Req Type	Condition	Value Set Constraint
							\$SectionLaterality = EV (G-A100, SRT, "Right") \$Anatomy = DCID (12111) Abdominal Arteries (lateral)
26 >	CONTAINS	INCLUDE	DTID (5103) Vascular Ultrasound Section	1	U		\$SectionScope = DT (T-46002, SRT, "Artery of Abdomen") \$SectionLaterality = EV (G-A103, SRT, "Unilateral") \$Anatomy = DCID (12112) Abdominal Arteries (unilateral)
27 >	CONTAINS	INCLUDE	DTID (5103) Vascular Ultrasound Section	1	U		\$SectionScope = DT (T-487A0, SRT, "Vein of Abdomen") \$SectionLaterality = EV (G-A101, SRT, "Left") \$Anatomy = DCID (12113) Abdominal Veins (lateral)
28 >	CONTAINS	INCLUDE	DTID (5103) Vascular Ultrasound Section	1	U		\$SectionScope = DT (T-487A0, SRT, "Vein of Abdomen") \$SectionLaterality = EV (G-A100, SRT, "Right") \$Anatomy = DCID (12113) Abdominal Veins (lateral)
29 >	CONTAINS	INCLUDE	DTID (5103) Vascular Ultrasound Section	1	U		\$SectionScope = DT (T-487A0, SRT, " Vein of Abdomen") \$SectionLaterality = EV (G-A103, SRT, "Unilateral") \$Anatomy = DCID (12114) Abdominal Veins (unilateral)
30 >	CONTAINS	INCLUDE	DTID (5105) Ultrasound Graft Section	1	U		

### TID 5101 Vascular Patient Characteristics

Patient Characteristic concepts in this template, which may replicate attributes in the Patient Study Module, are included here as possible targets of by-reference relationships from other content items in the SR tree.

Note: Several of the concepts in this template duplicate concepts in TID 1007 "Subject Context, Patient". The difference in use is that this template has those concepts as primary observations of the patient, while in TID 1007 the concepts are used to set (or reset) the context for other observations.

### TID 5101 Vascular Patient Characteristics Type: Extensible

NL	Rel with Parent	VT	Concept Name	VM	Req Type	Condition	Value Set Constraint
1		CONTAINER	EV (121118, DCM, "Patient Characteristics")	1	M		
2 >	CONTAINS	NUM	EV (121033, DCM, "Subject Age")	1	U		Units = DCID (7456) Units of Measure for Age
3 >	CONTAINS	CODE	EV (121032, DCM, "Subject Sex")	1	U		DCID (7455) Sex
4 >	CONTAINS	NUM	EV (8867-4, LN, "Heart Rate")	1	U		
5 >	CONTAINS	NUM	EV (F-008EC, SRT, "Systolic Blood Pressure")	1	U		
6 >	CONTAINS	NUM	EV (F-008ED, SRT, "Diastolic Blood Pressure")	1	U		

**TID 5102 Vascular Procedure Summary Section**

Comments and observations of the procedure of immediate clinical interest.

**TID 5102  
VASCULAR PROCEDURE SUMMARY SECTION  
Type: Extensible**

	NL	Rel with Parent	VT	Concept Name	VM	Req Type	Condition	Value Set Constraint
1			CONTAINER	DT (121111, DCM, "Summary")	1	M		
2	>		TEXT	DCID (12101) Vascular Summary	1-n	M		

**TID 5103 Vascular Ultrasound Section**

Sections of a vascular ultrasound report are section containers of an anatomic region consisting of measurement group containers that contain the measurements.

Parameter Name	Parameter Usage
\$SectionScope	The concept name of the section heading modifier
\$SectionLaterality	The laterality (if any) of the anatomy in this section heading
\$Anatomy	The concept name of the vascular anatomy
\$AnatomyRatio	The concept name of anatomy-coordinated ratio concepts

**TID 5103  
VASCULAR ULTRASOUND SECTION  
Type: Extensible**

	NL	Rel with Parent	VT	Concept Name	VM	Req Type	Condition	Value Set Constraint
1			CONTAINER	DT (121070, DCM, "Findings")	1	M		
2	>	HAS CONCEPT MOD	CODE	EV (G-C0E3, SRT, "Finding Site")	1	M		\$SectionScope
3	>	HAS CONCEPT MOD	CODE	EV (G-C171, SRT, "Laterality")	1	M		\$SectionLaterality
4	>	CONTAINS	INCLUDE	DTID (5104) Vascular Measurement Group	1-n	M		\$AnatomyGroup = \$Anatomy
5	>	CONTAINS	INCLUDE	DTID (300) Measurement	1-n	U		\$Measurement = \$AnatomyRatio

**TID 5104 Vascular Ultrasound Measurement Group**

This template is an anatomy specific container of measurements.

Parameter Name	Parameter Usage
\$AnatomyGroup	The concept name of the vascular anatomy

**TID 5104**  
**VASCULAR ULTRASOUND MEASUREMENT GROUP**  
Type: Extensible

NL	Rel with Parent	VT	Concept Name	VM	Req Type	Condition	Value Set Constraint
1		CONTAINER	\$AnatomyGroup	1	M		
2	>	HAS CONCEPT MOD	CODE EV (G-A1F8, SRT, "Topographical Modifier")	1	U		DCID (12116) Vessel Segment Modifiers
3	>	HAS CONCEPT MOD	CODE EV (125101, DCM, "Vessel Branch")	1-n	U		DCID (12117) Vessel Branch Modifiers
4	>	CONTAINS	INCLUDE DTID (300) Measurement	1-n	M		\$Measurement = DCID (12119) Vascular Ultrasound Property \$Derivation = DCID (3627) Measurement Type
5	>>	HAS CONCEPT MOD	CODE EV (R-4089A, SRT, "Cardiac Cycle Point")	1	U		DCID (12233) Cardiac Phase
6	>>	HAS CONCEPT MOD	CODE EV (R-41FFC, SRT, "Temporal period related to eating")	1	U		DT (G-A491, SRT, "Post-prandial")

**Content Item Descriptions**

Row 1	Specifies the anatomic context of the observations in the group.
Row 2	Details the anatomical location, e.g. proximal, middle, or distal
Row 3	The particular vessel branch, such as the inferior, medial or lateral
Row 5	Cardiac phase (systolic, diastolic), especially for aorta measurements
Row 6	Eating phase, especially for mesenteric and celiac measurements



**TID 5105 Ultrasound Graft Section**

This template is a container of measurements on a vascular graft.

**TID 5105  
ULTRASOUND GRAFT SECTION  
Type: Extensible**

	NL	Rel with Parent	VT	Concept Name	VM	Req Type	Condition	Value Set Constraint
1			CONTAINER	DT (121070, DCM, "Findings")	1	M		
2	>	HAS CONCEPT MOD	CODE	EV (G-C0E3, SRT, "Finding Site")	1	M		DT (T-D000F, SRT, "Vascular Graft")
3	>	HAS CONCEPT MOD	CODE	EV (G-C171, SRT, "Laterality")	1	U		DCID (244) Laterality
4	>	HAS CONCEPT MOD	CODE	DT (G-D871, SRT, "Proximal anastomosis")	1	M		BCID (12103) Vascular Ultrasound Anatomic Location
5	>	HAS CONCEPT MOD	CODE	DT (G-D872, SRT, "Distal Anastomosis")	1	M		BCID (12103) Vascular Ultrasound Anatomic Location
6	>	HAS CONCEPT MOD	CODE	DT (125102, DCM, "Graft Type")	1	U		No BCID
7	>	CONTAINS	INCLUDE	DTID (300) Measurement	1-n	M		\$Measurement = DCID (12119) Vascular Ultrasound Property

**Content Item Descriptions**

Proximal anastomosis	The proximal location of the graft
Distal anastomosis	The distal location of the graft
Graft type	The type of graft, e.g. "in situ", "prosthetic", "autogenous"

**ECHOCARDIOGRAPHY PROCEDURE REPORT TEMPLATES**

**TID 5200 Echocardiography Procedure Report**

This template forms the top of a content tree that allows an ultrasound device to describe the results of an adult echocardiography imaging procedure. It is instantiated at the root node. It can also be included in other templates that need to incorporate echocardiography findings into another report as quoted evidence.

**TID 5200 – Echocardiography Procedure Report  
Type: Extensible**

	NL	Rel with Parent	VT	Concept Name	VM	Req Type	Condition	Value Set Constraint
1			CONTAINER	EV (125200, DCM, "Adult Echocardiography Procedure Report")	1	M		
2	>	HAS CONCEPT MOD	INCLUDE	DTID (1204) Language of Content Item and Descendants	1	U		
3	>	HAS OBS CONTEXT	INCLUDE	DTID (1001) Observation Context	1	M		
4	>	CONTAINS	INCLUDE	DTID (5201) Echocardiography Patient Characteristics	1	U		
5	>	CONTAINS	CONTAINER	(111028, DCM, "Image Library")	1	U		

	NL	Rel with Parent	VT	Concept Name	VM	Req Type	Condition	Value Set Constraint
6	>>	CONTAINS	IMAGE	No purpose of reference	1-n	M		
7	>	CONTAINS	INCLUDE	DTID (5202) Echo Section	1	U		\$SectionSubject = EV (T-32600, SRT, "Left Ventricle") \$MeasType = DCID (12200) Echocardiography Left Ventricle
8	>	CONTAINS	INCLUDE	DTID (5202) Echo Section	1	U		\$SectionSubject = EV (T-32500, SRT, "Right Ventricle") \$MeasType = DCID (12204) Echocardiography Right Ventricle
9	>	CONTAINS	INCLUDE	DTID (5202) Echo Section	1	U		\$SectionSubject = EV (T-32300, SRT, "Left Atrium") \$MeasType = DCID (12205) Echocardiography Left Atrium
10	>	CONTAINS	INCLUDE	DTID (5202) Echo Section	1	U		\$SectionSubject = EV (T-32200, SRT, "Right Atrium") \$MeasType = DCID (12206) Echocardiography Right Atrium
11	>	CONTAINS	INCLUDE	DTID (5202) Echo Section	1	U		\$SectionSubject = EV (T-35400, SRT, "Aortic Valve") \$MeasType = DCID (12211) Echocardiography Aortic Valve
12	>	CONTAINS	INCLUDE	DTID (5202) Echo Section	1	U		\$SectionSubject = EV (T-35300, SRT, "Mitral Valve") \$MeasType = DCID (12207) Echocardiography Mitral Valve
13	>	CONTAINS	INCLUDE	DTID (5202) Echo Section	1	U		\$SectionSubject = EV (T-35200, SRT, "Pulmonic Valve") \$MeasType = DCID (12209) Echocardiography Pulmonic Valve
14	>	CONTAINS	INCLUDE	DTID (5202) Echo Section	1	U		\$SectionSubject = EV (T-35100, SRT, "Tricuspid Valve") \$MeasType = DCID (12208) Echocardiography Tricuspid Valve
15	>	CONTAINS	INCLUDE	DTID (5202) Echo Section	1	U		\$SectionSubject = EV (T-42000, SRT, "Aorta") \$MeasType= DCID (12212) Echocardiography Aorta
16	>	CONTAINS	INCLUDE	DTID (5202) Echo Section	1	U		\$SectionSubject = EV (T-44000, SRT, "Pulmonary artery") \$MeasType DCID (12210) = Echocardiography Pulmonary Artery
17	>	CONTAINS	INCLUDE	DTID (5202) Echo Section	1	U		\$SectionSubject = EV (T-48600, SRT, "Vena Cava") \$MeasType = DCID (12215) Echocardiography Vena Cavae
18	>	CONTAINS	INCLUDE	DTID (5202) Echo Section	1	U		\$SectionSubject = EV (T-48581, SRT, "Pulmonary Venous Structure") \$MeasType = DCID (12214) Echocardiography Pulmonary Veins
19	>	CONTAINS	INCLUDE	DTID (5202) Echo Section	1	U		\$SectionSubject = EV (P5-30031, SRT, "Cardiac Shunt Study") \$MeasType = DCID (12217) Echocardiography Cardiac Shunt
20	>	CONTAINS	INCLUDE	DTID (5202) Echo Section	1	U		\$SectionSubject = EV (D4-30000, SRT, "Congenital Anomaly of Cardiovascular System") \$MeasType = DCID (12218) Echocardiography Congenital
21	>	CONTAINS	INCLUDE	DTID (5204) Wall Motion Analysis	1-n	U		

### Content Item Descriptions

Row 21

The wall motion findings of stress stage. There may be multiple Template instances to report wall motion findings of multiple stages.

- Standard -

**TID 5201 Echocardiography Patient Characteristics**

Patient Characteristic concepts in this template, which may replicate attributes in the Patient Study Module, are included here as possible targets of by-reference relationships from other content items in the SR tree.

Note: Several of the concepts in this template duplicate concepts in TID 1007 "Subject Context, Patient". The difference in use is that this template has those concepts as primary observations of the patient, while in TID 1007 the concepts are used to set (or reset) the context for other observations.

**TID 5201  
Echocardiography Patient Characteristics  
Type: Extensible**

NL	Rel with Parent	VT	Concept Name	VM	Req Type	Condition	Value Set Constraint
1		CONTAINER	EV (121118, DCM, "Patient Characteristics")	1	M		
2	>	CONTAINS	NUM	EV (121033, DCM, "Subject Age")	1	U	Units = DCID (7456) Units of Measure for Age
3	>	CONTAINS	CODE	EV (121032, DCM, "Subject Sex")	1	U	DCID (7455) Sex
4	>	CONTAINS	NUM	EV (8867-4, LN, "Heart Rate")	1	U	
5	>	CONTAINS	NUM	EV (F-008EC, SRT, "Systolic Blood Pressure")	1	U	
6	>	CONTAINS	NUM	EV (F-008ED, SRT, "Diastolic Blood Pressure")	1	U	
7	>	CONTAINS	NUM	EV (8277-6, LN, "Body Surface Area")	1	M	
8	>>	INFERRED FROM	CODE	EV (8278-4, LN, "Body Surface Area Formula")	1	U	BCID (3663) Body Surface Area Equations

**TID 5202 Echo Section**

This is a generic section heading Template for any of the anatomical headings. Measurements within a section heading appear as groups (by image mode or acquisition protocol).

Parameter Name	Parameter Usage
\$SectionSubject	The subject modifier of the section heading container
\$MeasType	The concept name of the measurement

**TID 5202  
ECHO SECTION  
Type: Extensible**

NL	Rel with Parent	VT	Concept Name	VM	Req Type	Condition	Value Set Constraint
1		CONTAINER	EV (121070, DCM, "Findings")	1	M		
2	>	HAS CONCEPT MOD	CODE	EV (G-C0E3, SRT, "Finding Site")	1	M	\$SectionSubject
3	>	CONTAINS	CONTAINER	DT (125007, DCM, "Measurement Group")	1-n	M	
4	>>	HAS CONCEPT	CODE	EV (G-0373, SRT, "Image Mode")	1	U	BCID (12224) Ultrasound Image Modes

	NL	Rel with Parent	VT	Concept Name	VM	Req Type	Condition	Value Set Constraint
		MOD						
5	>>	HAS CONCEPT MOD	CODE	DT (125203,DCM,"Acquisition Protocol")	1	U		
6	>>	CONTAINS	INCLUDE	DTID (5203) Echo Measurement	1-n	M		\$Measurement = \$MeasType \$Method=CID (12227) Echocardiography Measurement Method

### Echo Section Descriptions

Rows 4, 5

Type of measurement group. May be grouped by image mode, or acquisition protocol, or some other user or manufacturer designated classification

### TID 5203 Echo Measurement

Parameter Name	Parameter Usage
\$Measurement	Coded term or Context Group for Concept Name of measurement
\$Method	Value for Measurement Method

### TID 5203 Echo Measurement Type: Extensible

	NL	Relation with Parent	Value Type	Concept Name	VM	Req Type	Condition	Value Set Constraint
1			INCLUDE	DTID (300) Measurement	1	M		\$Measurement = \$Measurement \$Method = \$Method \$TargetSite = BCID (12236) Echo Anatomic Sites \$TargetSiteMod = BCID (12237) Echocardiography Anatomic Site Modifiers
2	>	HAS CONCEPT MOD	CODE	EV (G-C048, SRT, "Flow Direction")	1	U		BCID (12221) Flow Direction
3	>	HAS CONCEPT MOD	CODE	EV (R-40899, SRT, "Respiratory Cycle Point")	1	U		DCID (12234) Respiration State
4	>	HAS CONCEPT MOD	CODE	EV (R-4089A, SRT, "Cardiac Cycle Point")	1	U		DCID (12233) Cardiac Phase
5	>	HAS ACQ CONTEXT	CODE	EV (G-0373, SRT, "Image Mode")	1	U		DCID (12224) Ultrasound Image Modes
6	>	HAS ACQ CONTEXT	CODE	EV (111031, DCM, "Image View")	1	U		BCID (12226) Echocardiography Image View

**TID 5204 Echocardiography Wall Motion Analysis**

The Wall Motion Analysis Template is used to document wall motion scoring.

**TID 5204  
Wall Motion Analysis  
Type: Extensible**

	NL	Relation with Parent	Value Type	Concept Name	VM	Req Type	Condition	Value Set Constraint
1			CONTAINER	EV (121070, DCM, "Findings")		M		
2	>	HAS CONCEPT MOD	CODE	EV (121058, DCM, "Procedure reported")	1	M		DT (P5-B3121, SRT, "Echocardiography for Determining Ventricular Contraction")
3	>	HAS ACQ CONTEXT	CODE	EV (LN, 18139-6, "Stage")	1	U		BCID (12002) Ultrasound Protocol Stage Types
4	>	CONTAINS	IMAGE	EV (125201, DCM, "Illustration of Finding")	1	U		
5	>	CONTAINS	TEXT	EV (LN, 18118-0, "LV Wall Motion Segmental Findings")	1	U		
6	>	CONTAINS	NUM	DT (125202, DCM, "LV Wall Motion Score Index")	1	U		
7	>>	HAS CONCEPT MOD	CODE	EV (G-E048, SRT, "Assessment Scale")	1	M		BCID (12238) Wall Motion Scoring Scheme
8	>	CONTAINS	CONTAINER	EV (121070, DCM, "Findings")	1	UC	IF observer specifies a score	
10	>>	HAS CONCEPT MOD	CODE	EV (G-C0E3, SRT, "Finding Site")	1	M		DT (T-D0772, SRT, "Myocardial Wall")
11	>>	CONTAINS	CODE	EV (LN, 18179-2, "Wall Segment")	1-n	M		BCID (3717) Myocardial Wall Segments
12	>>>	HAS PROPERTIES	CODE	EV (F-32050, SRT, "Cardiac Wall Motion")	1	MC	IF row 13 is absent	DCID (3703) Wall Motion
13	>>>	HAS PROPERTIES	CODE	EV (G-C504, SRT, "Associated Morphology")	1	MC	IF row 12 is absent	DCID (3704) Myocardium Wall Morphology Findings
14	>>>	HAS PROPERTIES	NUM	DT (G-C1E3, SRT, "Score")	1	U		

**Wall Motion Analysis Item Descriptions**

- Row 3                    The stage of the ultrasound protocol at which these findings were scored. This row may be absent if this is a generic, non-staged scoring.
- Row 4                    Image that graphically depicts the segments and their scores.
- Row 5                    Text narration accompanying this stage.
- Row 6                    The composite score computed from the average of the scored segments
- Row 7                    The type of scoring scheme used to score this exam.
- Row 8                    A container of all of the individual segment findings for this stage. The container shall be present if the observer makes an assessment, including the assessment of Not Visualized. It shall not be present if no evaluation was made.
- Rows 12, 13            Scar/thinning (in Row 13) may accompany akinesis and dyskinesis (in Row 12).
- Row 14                    A numeric designation for the score. Score ranges vary, typically 0-4 or 0-5.

Numeric scores may depend on wall motion findings as well as morphology findings. See the table below for conventional numeric assignment schemes. The UCUM annotation code enables specifying the numeric range, ("L:N"), UCUM, "scale L:N"), where L and N are the lower and upper ends of the range.

**Table 5204-1 Numeric Score Assignment for Segmental Findings**

A description of the scoring schemes described in the table below is available in *Recommendations for Quantitation of the Left Ventricle by Two-Dimensional Echocardiography*, Journal of the American Society of Echocardiography, Vol 2, No 5 358-367, Oct 1989.

Conventional Numeric Assignment	Wall Motion Finding or Morphology Finding		
	4 Point	5 Point	5 Point with Graded Hypokinesis
-1	(F-32050, SRT, "Cardiac Wall Motion") = (R-0030D SRT, "Hyperkinesis")	(F-32050, SRT, "Cardiac Wall Motion") = (R-0030D, SRT, "Hyperkinesis")	(F-32050, SRT, "Cardiac Wall Motion") = (R-0030D, SRT, "Hyperkinesis")
0	(F-32050, SRT, "Cardiac Wall Motion") = (122288, DCM, "Not Visualized")	(F-32050, SRT, "Cardiac Wall Motion") = (122288, DCM, "Not Visualized")	(F-32050, SRT, "Cardiac Wall Motion") = (122288, DCM, "Not Visualized")
1	(F-32050, SRT, "Cardiac Wall Motion") = (R-00344, SRT, "Normal Wall Motion")	(F-32050, SRT, "Cardiac Wall Motion") = (R-00344, SRT, "Normal Wall Motion")	(F-32050, SRT, "Cardiac Wall Motion") = (R-00344, SRT, "Normal Wall Motion")
1.5			(F-32050, SRT, "Cardiac Wall Motion") = (R-00327, SRT, "Mild Hypokinesis")
2	(F-32050, SRT, "Cardiac Wall Motion") = (R-4041B, SRT, "Hypokinesis")	(F-32050, SRT, "Cardiac Wall Motion") = (R-4041B, SRT, "Hypokinesis")	(F-32050, SRT, "Cardiac Wall Motion") = (R-0032F, SRT, "Moderate Hypokinesis")
2.5			(F-32050, SRT, "Cardiac Wall Motion") = (R-00370, SRT, "Severe Hypokinesis")
3	(F-32050, SRT, "Cardiac Wall Motion") = (F-30004, SRT, "Akinesis")	(F-32050, SRT, "Cardiac Wall Motion") = (F-30004, SRT, "Akinesis")	(F-32050, SRT, "Cardiac Wall Motion") = (F-30004, SRT, "Akinesis")
4	(F-32050, SRT, "Cardiac Wall Motion") = (F-32052, SRT, "Dyskinesis")	(F-32050, SRT, "Cardiac Wall Motion") = (F-32052, SRT, "Dyskinesis")	(F-32050, SRT, "Cardiac Wall Motion") = (F-32052, SRT, "Dyskinesis")
5		(G-C504, SRT, "Associated Morphology") = (D3-10510, SRT, "Ventricular Aneurysm")	(G-C504, SRT, "Associated Morphology") = (D3-10510, SRT, "Ventricular Aneurysm")

**RELEVANT PATIENT INFORMATION TEMPLATES**

**TID 9000 Relevant Patient Information For Breast Imaging**

This template collects a patient's relevant information as it relates to breast imaging. This template, together with its subordinate templates, describes the history of a patient's reproductive system, hormone medications, past procedures, risk factors, and indicated problems as they relate to breast health.

**TID 9000**

**RELEVANT PATIENT INFORMATION FOR BREAST IMAGING**

**Type: Extensible**

	NL	Rel with Parent	VT	Concept Name	VM	Req Type	Condition	Value Set Constraint
1			CONTAINER	EV (111511, DCM, "Relevant Patient Information for Breast Imaging")	1	M		
2	>	HAS CONCEPT MOD	INCLUDE	DTID (1204) Language of Content Item and Descendants	1	M		
3	>	CONTAINS	INCLUDE	DTID (3114) Patient Assessment	1	U		
4	>	CONTAINS	INCLUDE	DTID (9001) Gynecological History	1	U		
5	>	CONTAINS	INCLUDE	DTID (9002) Medication, Substance, Environmental Exposure	1	U		\$ContainerConcept= EV ( 10160-2, LN, "History Of Medication Use") \$CodeConcept= EV (111516, DCM, "Medication Type") \$CodeValue = DCID (6080) Gynecological Hormones
6	>	CONTAINS	INCLUDE	DTID (9003) Previous Procedure	1	U		\$ProcedureList = DCID (6083) Procedures for Breast, DCID (6082) Gynecological Procedures \$ProcedureModifier = DCID (6058) Procedure Modifiers for Breast \$NumConceptName= DCID (6095) Numeric Properties of Procedures \$LateralityValue = DCID (6022) Side \$ProcedureResult = DCID (6063) Interventional Procedure Results \$ComplicationValue= DCID (6062) Interventional

	NL	Rel with Parent	VT	Concept Name	VM	Req Type	Condition	Value Set Constraint
								Procedure Complications
7	>	CONTAINS	INCLUDE	DTID (9004) Indicated Problem	1	U		\$ProblemList = DCID (6055) Breast Clinical Finding or Indicated Problem \$LateralityValue = DCID (6022) Side \$LocationValue = DCID (6018) Clockface Location or Region , DCID (6020) Quadrant Location
8	>	CONTAINS	INCLUDE	DTID (9005) Risk Factor	1	U		\$RiskList = DCID (6081) Breast Cancer Risk Factors \$FamilyList = DCID (7451) Family Member

### TID 9001 Gynecological History

This general template collects the details of a patient's reproductive system history, such as number of births, and gynecological surgery history.

#### TID 9001

#### GYNECOLOGICAL HISTORY

Type: Extensible

	NL	Rel with Parent	VT	Concept Name	VM	Req Type	Condition	Value Set Constraint
1			CONTAINER	EV (R-20767, SRT, "Gynecological History")	1	M		
2	>	HAS OBS CONTEXT	CODE	EV (111534, DCM, "Role of person reporting")	1	U		DCID (7450) Person Roles
3	>	CONTAINS	DATE	EV (11955-2, LN, "Date of last menstrual period")	1	U		
4	>	CONTAINS	NUM	EV (111518, DCM, "Age when first menstrual period occurred")	1	U		UNITS = EV (a,UCUM,"Year")
5	>	CONTAINS	NUM	EV (111519, DCM, "Age at First Full Term Pregnancy")	1	U		UNITS = EV (a,UCUM,"Year")
6	>	CONTAINS	NUM	EV (11977-6, LN, "Para")	1	U		UNITS = EV (1,UCUM,"no units")
7	>	CONTAINS	NUM	EV (11639-2, LN, "Term")	1	U		UNITS = EV (1,UCUM,"no units")
8	>	CONTAINS	NUM	EV (11637-6, LN, "Preterm")	1	U		UNITS = EV (1,UCUM,"no units")



	NL	Rel with Parent	VT	Concept Name	VM	Req Type	Condition	Value Set Constraint
9	>	CONTAINS	NUM	EV (11636-8, LN, "Living")	1	U		UNITS = EV (1,UCUM,"no units")
10	>	CONTAINS	NUM	EV (11636-8, LN, "LBW or IUGR")	1	U		UNITS = EV (1,UCUM,"no units")
11	>	CONTAINS	NUM	EV (11996-6, LN, "Gravida")	1	U		UNITS = EV (1,UCUM,"no units")
12	>	CONTAINS	NUM	EV (11612-9, LN, "Aborta")	1	U		UNITS = EV (1,UCUM,"no units")
13	>	CONTAINS	NUM	EV (33065-4, LN, "Ectopic Pregnancies")	1	U		UNITS = EV (1,UCUM,"no units")
14	>	CONTAINS	NUM	EV (111520, DCM, "Age at Menopause")	1	U		UNITS = EV (a,UCUM,"Year")
15	>	CONTAINS	NUM	EV (111521, DCM, "Age when hysterectomy performed")	1	U		UNITS = EV (a,UCUM,"Year")
16	>>	HAS CONCEPT MOD	CODE	EV (R-404ED, SRT, "Extent")	1	U		EV (R-404F1, SRT, "Complete") or EV (R-404FE, SRT, "Partial")
17	>	CONTAINS	NUM	EV (111522, DCM, "Age when left ovary removed")	1	U		UNITS = EV (a,UCUM,"Year")
18	>	CONTAINS	NUM	EV (111523, DCM, "Age when right ovary removed")	1	U		UNITS = EV (a,UCUM,"Year")
19	>	CONTAINS	CODE	EV (111543, DCM, "Breast feeding history")	1	U		DCID (230) Yes-No
20	>>	HAS PROPERTIES	NUM	EV (111544, DCM, "Average breast feeding period")	1	U		UNITS = EV (wk,UCUM,"Week")
21	>	CONTAINS	CODE	EV (111532, DCM, "Pregnancy Status")	1	U		DCID (6096) Pregnancy Status
22	>	CONTAINS	CODE	EV (111391, DCM, "Menstrual Cycle Phase")	1	U		DCID (6163) Menstrual Cycle Phase

### TID 9002 Medication, Substance, Environmental Exposure

This general template provides detailed information on a patient's medication or substance use, or exposure to environmental factors, including type and duration of use or exposure.

Parameter Name	Parameter Usage
\$ContainerConcept	Coded term for the concept name of the CONTAINER, identifying it as medication, substance, or environmental exposure history.
\$CodeConcept	Coded term for the concept name of the

	CODE, identifying it as medication, substance, or environmental exposure.
\$CodeValue	Coded term or Context Group for value of the medication, substance, or environmental exposure.

**TID 9002**

**MEDICATION, SUBSTANCE, ENVIRONMENTAL EXPOSURE**

**Type: Extensible**

	NL	Rel with Parent	VT	Concept Name	VM	Req Type	Condition	Value Set Constraint
1			CONTAINER	\$ContainerConcept	1	M		
2	>	CONTAINS	CODE	\$CodeConcept	1-n	M		\$CodeValue
3	>>	HAS CONCEPT MOD	CODE	EV (G-C032, SRT, "Classification")	1	U		
4	>>	HAS OBS CONTEXT	CODE	EV (111534, DCM, "Role of person reporting")	1	U		DCID (7450) Person Roles
5	>>	HAS PROPERTIES	NUM	EV (111524, DCM, "Age Started")	1	U		UNITS = EV (a,UCUM,"Year")
6	>>	HAS PROPERTIES	NUM	EV (111525, DCM, "Age Ended")	1	U		UNITS = EV (a,UCUM,"Year")
7	>>	HAS PROPERTIES	DATETIME	EV (111526, DCM, "Datetime Started")	1	U		
8	>>	HAS PROPERTIES	DATETIME	EV (111527, DCM, "Datetime Ended")	1	U		
9	>>	HAS PROPERTIES	NUM	EV (G-7290, SRT, "Duration")	1	U		UNITS = DCID (6046) Units of Follow-up Interval
10	>>	HAS PROPERTIES	CODE	EV (111528, DCM, "Ongoing")	1	U		DCID (230) Yes-No
11	>>	HAS PROPERTIES	TEXT	EV (111529, DCM, "Brand Name")	1	U		
12	>>	HAS PROPERTIES	NUM	DCID (6092) Quantitative Concepts for Usage, Exposure	1	U		The unit of measure shall be quantity per unit of time
13	>>	HAS PROPERTIES	CODE	DCID (6093) Qualitative Concepts for Usage, Exposure Amount	1	U		DCID (6090) Relative Usage, Exposure Amount
14	>>	HAS PROPERTIES	CODE	DCID (6094) Qualitative Concepts for Usage, Exposure Frequency	1	U		DCID (6091) Relative Frequency of Event Values

**Content Item Descriptions**

Row 3 "Classification"	No context group is provided for the value set, but it is recommended that values from a standard external coding scheme, such as SRT or NDC, be used.
Rows 13 & 14	If both of these content items are instantiated, the concept names selected for each should match. For example, use "Relative dose amount" as the concept name for row 13 with "Relative dose frequency" as the concept name for row 14.

**TID 9003 Previous Procedure**

This general template provides detailed information on a patient's previous procedure, surgery, or treatment.

Parameter Name	Parameter Usage
\$ProcedureList	Coded term or Context Group for value of Previous Procedure
\$ProcedureModifier	Coded term or Context Group for value of Previous Procedure Modifier
\$NumConceptName	Coded term or Context Group for the concept name of a numeric property of the Previous Procedure
\$LateralityValue	Coded term or Context Group for value of Laterality
\$ProcedureResult	Coded term or Context Group for value of Result of Procedure
\$ComplicationValue	Coded term or Context Group for value of Complication

**TID 9003**

**PREVIOUS PROCEDURE**

**Type: Extensible**

	NL	Rel with Parent	VT	Concept Name	VM	Req Type	Condition	Value Set Constraint
1			CONTAINER	EV (111513, DCM, "Relevant Previous Procedures")	1	M		
2	>	CONTAINS	CODE	EV (111531, DCM, "Previous Procedure")	1-n	M		\$ProcedureList
3	>>	HAS CONCEPT MOD	CODE	EV (111464, DCM, "Procedure Modifier")	1-n	U		\$ProcedureModifier
4	>>	HAS OBS CONTEXT	CODE	EV (111534, DCM, "Role of person reporting")	1	U		DCID (7450) Person Roles
5	>>	HAS PROPERTIES	NUM	\$NumConceptName	1-n	U		

	NL	Rel with Parent	VT	Concept Name	VM	Req Type	Condition	Value Set Constraint
6	>>	HAS PROPERTIES	CODE	EV (G-C171, SRT, "Laterality")	1	U		\$LateralityValue
7	>>	HAS PROPERTIES	DATETIME	EV (122146, DCM, "Procedure Datetime")	1	UC	XOR row 8	
8	>>	HAS PROPERTIES	CODE	EV (111395, DCM, "Estimated Timeframe")	1	UC	XOR row 7	BCID (6164) Time Intervals
9	>>	HAS PROPERTIES	NUM	EV (R-42009, SRT, "Number of occurrences")	1	U		UNITS = EV (1,UCUM,"no units")
10	>>	HAS PROPERTIES	CODE	EV (DD-60002, SRT, "Complication of procedure")	1-n	U		\$ComplicationValue
11	>>>	HAS PROPERTIES	CODE	EV (111466, DCM, "Severity of Complication")	1	U		DCID (251) Severity of Complication
12	>>	HAS PROPERTIES	CODE	EV (122177, DCM, "Procedure Result")	1	U		\$ProcedureResult
13	>>	HAS PROPERTIES	INCLUDE	TID (4207) Pathology Results	1-n	U		

**TID 9004 Indicated Problem**

This general template provides information about indicated problems presented by a patient. For example, indicated breast problems relating to the purpose for a mammographic examination.

Parameter Name	Parameter Usage
\$ProblemList	Coded term or Context Group for value of Indicated Problem
\$LateralityValue	Coded term or Context Group for value of Laterality
\$LocationValue	Coded term or Context Group for value of Location

**TID 9004**

**INDICATED PROBLEM**

**Type: Extensible**

	NL	Rel with Parent	VT	Concept Name	VM	Req Type	Condition	Value Set Constraint
1			CONTAINER	EV ( 11450-4, LN, "Problem List")	1	M		
2	>	CONTAINS	CODE	EV (111533, DCM, "Indicated Problem")	1-n	M		\$ProblemList
3	>>	HAS OBS CONTEXT	CODE	EV (111534, DCM, "Role of person reporting")	1	U		DCID (7450) Person Roles
4	>>	HAS OBS CONTEXT	DATETIME	EV (111535, DCM, "Datetime problem observed")	1	U		
5	>>	HAS PROPERTIES	CODE	EV (G-C171, SRT, "Laterality")	1	U		\$LateralityValue
6	>>	HAS PROPERTIES	CODE	EV (G-C0E3, SRT, "Finding site")	1	U		\$LocationValue
7	>>	HAS PROPERTIES	NUM	EV (G-7290, SRT, "Duration")	1	U		
8	>>	HAS PROPERTIES	CODE	EV (R-407E7, SRT, "Frequency")	1	U		DCID (6091) Relative Frequency of Event Values
9	>>	HAS PROPERTIES	DATETIME	EV (111536, DCM, "Datetime of last evaluation")	1	U		
10	>>	HAS PROPERTIES	TEXT	EV (122106, DCM, "Comment")	1	U		

**TID 9005 Risk Factor**

This general template provides detailed information on the risk factors for a patient, related to medical history for themselves and family members.

Parameter Name	Parameter Usage
\$RiskList	Coded term or Context Group for value of Risk Factor
\$FamilyList	Coded term or Context Group for value of Family Member with Risk Factor

**TID 9005**

**RISK FACTOR**

Type: Extensible

	NL	Rel with Parent	VT	Concept Name	VM	Req Type	Condition	Value Set Constraint
1			CONTAINER	EV (111515, DCM, "Relevant Risk Factors")	1	M		
2	>	CONTAINS	CODE	EV (F-01500, SRT, "Risk factor")	1-n	M		\$RiskList
3	>>	HAS CONCEPT MOD	CODE	EV (111530, DCM, "Risk Factor modifier")	1	U		EV (G-0002, SRT, "Family history of")
4	>>	HAS CONCEPT MOD	NUM	EV(18185-9, LN, "Gestational Age")	1	UC	IFF value of row 2 is (G-0305, SRT, "History of – premature delivery")	
5	>>	HAS OBS CONTEXT	CODE	EV (111534, DCM, "Role of person reporting")	1	U		DCID (7450) Person Roles
6	>>	HAS PROPERTIES	NUM	EV (111538, DCM, "Age at Occurrence")	1	U		UNITS = EV (a,UCUM,"Year")
7	>>	HAS PROPERTIES	NUM	EV (G-7290, SRT, "Duration")	1	U		UNITS = DCID (6046) Units of Follow-up Interval
8	>>	HAS PROPERTIES	TEXT	EV (121106, DCM, "Comment")	1	U		
9	>>	INFERRED FROM	CODE	EV (111537, DCM, "Family Member with Risk Factor")	1-n	U		\$FamilyList
10	>>>	HAS CONCEPT MOD	NUM	EV (111538, DCM, "Age at Occurrence")	1	U		UNITS = EV (a,UCUM,"Year")
11	>>>	HAS CONCEPT MOD	CODE	EV (111539, DCM, "Menopausal phase")	1	U		DCID (6086) Menopausal Phase

	NL	Rel with Parent	VT	Concept Name	VM	Req Type	Condition	Value Set Constraint
12	>>>	HAS CONCEPT MOD	CODE	EV (111540, DCM, "Side of Family")	1	U		DCID (6097) Side of Family

**TID 9006 Obstetric History**

This general template collects the details of a patient's obstetric history for a current pregnancy. Information regarding previous pregnancies is conveyed using the Gynecological History Template.

**TID 9006**

**OBSTETRIC HISTORY**

**Type: Extensible**

	NL	Rel with Parent	VT	Concept Name	VM	Req Type	Condition	Value Set Constraint
1		CONTAINS	CONTAINER	EV (R-20658, SRT, "Obstetric History")	1	M		
2	>	CONTAINS	DATE	DCID (12003) OB-GYN Dates	1-n	U		
3	>	CONTAINS	NUM	EV (18185-9, LN, "Gestational Age")	1	U		UNITS= EV (d,UCUM, "Day")
4	>	CONTAINS	TEXT	EV (121106, DCM, "Comment")	1-n	U		

**Content Item Descriptions**

Row 3 "Gestational Age"	Observation DateTime (0040,A032) for Content Item shall be present, in order to convey the date and time at which this Gestational Age was established.
-------------------------	---

**TID 9007 General Relevant Patient Information**

This template collects a patient's relevant information for general purpose use. This template, together with its subordinate templates, describes the history of a patient's reproductive system, medications, substance use, environmental exposure, past procedures, risk factors, and indicated problems.

**TID 9007**

**GENERAL RELEVANT PATIENT INFORMATION**

**Type: Extensible**

	NL	Rel with Parent	VT	Concept Name	VM	Req Type	Condition	Value Set Constraint
1			CONTAINER	EV (111517, DCM, "Relevant Patient Information")	1	M		
2	>	HAS CONCEPT MOD	INCLUDE	DTID (1204) Language of Content Item and Descendants	1	M		

	NL	Rel with Parent	VT	Concept Name	VM	Req Type	Condition	Value Set Constraint
3	>	CONTAINS	INCLUDE	DTID (3114) Patient Assessment	1	U		
4	>	CONTAINS	INCLUDE	DTID (9002) Medication, Substance, Environmental Exposure	1	U		\$ContainerConcept= EV ( 10160-2, LN, "History Of Medication Use") \$CodeConcept= EV (111516, DCM, "Medication Type")
5	>	CONTAINS	INCLUDE	DTID (9002) Medication, Substance, Environmental Exposure	1	U		\$ContainerConcept= EV (111545, DCM, "Substance Use History") \$CodeConcept= EV (111546, DCM, "Used Substance Type") \$CodeValue= BCID (6089) Substances
6	>	CONTAINS	INCLUDE	DTID (9002) Medication, Substance, Environmental Exposure	1	U		\$ContainerConcept= EV (111547, DCM, "Environmental Exposure History") \$CodeConcept= EV (111548, DCM, "Environmental Factor")
7	>	CONTAINS	INCLUDE	DTID (9003) Previous Procedure	1	U		\$LateralityValue= BCID (244) Laterality
8	>	CONTAINS	INCLUDE	DTID (9004) Indicated Problem	1	U		\$LateralityValue= BCID (244) Laterality
9	>	CONTAINS	INCLUDE	DTID (9005) Risk Factor	1	U		\$RiskList= BCID (6087) General Risk Factors \$FamilyList= DCID (7451) Family Member
10	>	CONTAINS	INCLUDE	DTID (9001) Gynecological History	1	U		
11	>	CONTAINS	INCLUDE	DTID (9006) Obstetric History	1	U		
12	>	CONTAINS	INCLUDE	DTID (3802) Cardiovascular Patient History	1	U		
13	>	CONTAINS	INCLUDE	DTID (351) Previous Reports	1	U		

### X-RAY RADIATION DOSE SR IOD TEMPLATES

The templates that comprise the X-Ray Radiation Dose SR are interconnected as in Figure A-11.



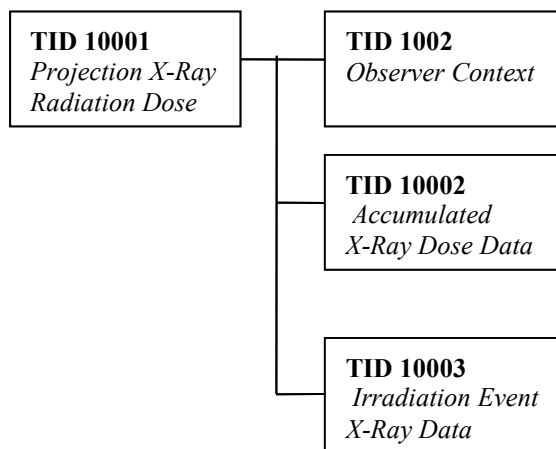

Figure A-11: X-Ray Radiation Dose SR IOD Template Structure

**TID 10001 Projection X-Ray Radiation Dose**

This template defines a container (the root) with subsidiary content items, each of which represents a single projection X-Ray irradiation event entry or plane-specific dose accumulations. There is a defined recording observer (the system or person responsible for recording the log, generally the system). A Biplane irradiation event will be recorded as two individual events, one for each plane. Accumulated values will be kept separate for each plane.

**TID 10001  
PROJECTION X-RAY RADIATION DOSE  
Type: Extensible**

	NL	Rel with Parent	VT	Concept Name	VM	Req Type	Condition	Value Set Constraint
1			CONTAINER	EV (113701, DCM, "X-Ray Radiation Dose Report")	1	M		
2	>	HAS CONCEPT MOD	CODE	EV (121058, DCM, "Procedure reported")	1	M		DT (113704, DCM, "Projection X-Ray")
3	>		INCLUDE	DTID (1002) Observer Context	1-n	M		
4	>	HAS OBS CONTEXT	CODE	EV (113705, DCM, "Scope of Accumulation")	1	M		DCID (10000) Scope of Accumulation
5	>>	HAS PROPERTIES	UIDREF	DCID (10001) UID Types	1	M		
6	>	CONTAINS	TEXT	EV (113780, DCM, "Reference Point Definition")	1	U		
7	>	CONTAINS	INCLUDE	DTID (10002) Accumulated X-Ray Dose	1	MC	IFF Single Plane system	\$Plane = EV (113622, DCM, "Single Plane")
8	>	CONTAINS	INCLUDE	DTID (10002) Accumulated X-Ray	1	MC	IFF Biplane system	\$Plane = EV (113620, DCM, "Plane A")

				Dose				
9	>	CONTAINS	INCLUDE	DTID (10002) Accumulated X-Ray Dose	1	MC	IFF Biplane system	\$Plane = EV (113621, DCM, "Plane B")
10	>	CONTAINS	INCLUDE	DTID (10003) Irradiation Event X- Ray Data	1-n	M		
11	>	CONTAINS	TEXT	EV (121106, DCM, "Comment")	1	U		

### Content Item Descriptions

Row 3	The observer context may include both a Person Observer identification, as well as the identity of the equipment providing the values for the irradiation event (Device Observer identification), if not inherited.
Row 6	This item defines the Reference Point (RP) used for RP-related dose values. The RP may be defined according to IEC 60601-2-43, or may use an implementation-specific definition.

### TID 10002 Accumulated X-Ray Dose

This general template provides detailed information on projection X-Ray dose value accumulations over several irradiation events from the same equipment (typically a study or a performed procedure step).

Parameter Name	Parameter Usage
\$Plane	Coded term identifying to which acquisition plane the encoded information belongs.

### TID 10002 ACCUMULATED X-RAY DOSE Type: Extensible

	NL	Rel with Parent	VT	Concept Name	VM	Req Type	Condition	Value Set Constraint
1			CONTAINER	EV (113702, DCM, "Accumulated X- Ray Dose Data")	1	M		
2	>	HAS CONCEPT MOD	CODE	EV (113764, DCM, "Acquisition Plane")	1	M		\$Plane
3	>	CONTAINS	TEXT	EV (113780, DCM, "Reference Point Definition")	1	U		
4	>	CONTAINS	CONTAINER	EV (122505, DCM, "Calibration")	1	M		
5	>>	HAS CONCEPT MOD	CODE	EV (113794, DCM, "Dose Measurement Device")	1-n	M		DCID (10010) Dose Measurement Devices
6	>>	CONTAINS	DATETIME	EV (113723, DCM, "Calibration Date")	1	M		
7	>>	CONTAINS	NUM	EV (122322, DCM, "Calibration Factor")	1	M		Units = EV (1, UCUM, "no units")
8	>>	CONTAINS	NUM	EV (113763, DCM, "Calibration Uncertainty")	1	M		Units = EV (% , UCUM, "Percent")
9	>>	CONTAINS	TEXT	EV (113724, DCM, "Calibration")	1	M		

				Responsible Party")				
10	>	CONTAINS	NUM	EV (113722, DCM, "Dose Area Product Total")	1	M		Units = EV (Gym2, UCUM, "Gym2")
11	>	CONTAINS	NUM	EV (113725, DCM, "Dose (RP) Total")	1	M		Units = EV (Gy, UCUM, "Gy")
12	>	CONTAINS	NUM	EV (113726, DCM, "Fluoro Dose Area Product Total")	1	MC	IFF TID(10003) Row 3 value = (P5-06000, SRT, "Fluoroscopy") for at least one irradiation event	Units = EV (Gym2, UCUM, "Gym2")
13	>	CONTAINS	NUM	EV (113728, DCM, "Fluoro Dose (RP) Total")	1	MC	IFF TID(10003) Row 3 value = (P5-06000, SRT, "Fluoroscopy") for at least one irradiation event	Units = EV (Gy, UCUM, "Gy")
14	>	CONTAINS	NUM	EV (113730, DCM, "Total Fluoro Time")	1	MC	IFF TID(10003) Row 3 value = (P5-06000, SRT, "Fluoroscopy") for at least one irradiation event.	Units = EV (s, UCUM, "s")
15	>	CONTAINS	NUM	EV (113727, DCM, "Acquisition Dose Area Product Total")	1	M		Units = EV (Gym2, UCUM, "Gym2")
16	>	CONTAINS	NUM	EV (113729, DCM, "Acquisition Dose (RP) Total")	1	M		Units = EV (Gy, UCUM, "Gy")
17	>	CONTAINS	NUM	EV (113731, DCM, "Total Number of Radiographic Frames")	1	U		Units = EV (1, UCUM, "no units")

### Content Item Descriptions

Row 3	Reference Point definition if not provided in TID 10001
Row 4	Date that the calibration of the equipment's dose indicators was performed
Row 7	Factor by which the measured dose area product total was multiplied to obtain the Dose Area Product Total (Row 10).
Row 8	Value range from 0 to 100 percent. Uncertainty of the 'actual' value expressed as +/- of the mean.
Row 9	Identifies Individual or organization responsible for calibration
Row 10	Sum of acquisition and fluoroscopy
Row 11	Sum of acquisition and fluoroscopy, relative to reference point.
Rows 12-14	Fluoroscopic component only
Rows 15-16	Acquisition component only

### TID 10003 Irradiation Event X-Ray Data

This template conveys the dose and equipment parameters of a single irradiation event.

An irradiation event is the occurrence of radiation being applied to a patient in single continuous time-frame between the start (release) and the stop (cease) of the irradiation. The irradiation event is the "smallest" information entity to be recorded in the realm of Radiation Dose reporting. Individual Irradiation Events are described by a set of accompanying physical parameters that are sufficient to understand the "quality" of irradiation that is being applied. This set of parameters may be different for the various types of equipment that are able to create irradiation events. Any on-off switching of the irradiation source during the event shall not be treated as separate events, rather the event includes the time between start

and stop of irradiation as triggered by the user. E.g., a pulsed fluoro X-Ray acquisition shall be treated as a single irradiation event.

As described in Section 6.2.4, measurement concepts may be post-coordinated, even though not explicitly specified in the Template. In particular, post-coordination using modifier concept (121401, DCM, "Derivation"), with modifier values drawn from CID 10009 Measured/Calculated would be appropriate to encode indications of measured or of calculated values.

**TID 10003**  
**IRRADIATION EVENT X-RAY DATA**  
**Type: Extensible**

	NL	Rel with Parent	VT	Concept Name	VM	Req Type	Condition	Value Set Constraint
1			CONTAINER	EV (113706, DCM, "Irradiation Event X-Ray Data")	1	M		
2	>	HAS CONCEPT MOD	CODE	EV (113764, DCM, "Acquisition Plane")	1	M		DCID (10003) Equipment Plane Identification
3	>	CONTAINS	CODE	EV (113721, DCM, "Irradiation Event Type")	1	M		DCID (10002) Irradiation Event Types
4	>	CONTAINS	TEXT	EV (125203, DCM, "Acquisition Protocol")	1	U		
5	>	CONTAINS	TEXT	EV (113780, DCM, "Reference Point Definition")	1	U		
6	>	CONTAINS	IMAGE	EV (113795, DCM, "Acquired Image")	1-n	MC	IFF Image Object is created for this irradiation event	
7	>	CONTAINS	UIDREF	EV (113769, DCM, "Irradiation Event UID")	1	M		
8	>	CONTAINS	NUM	EV (122130, DCM, "Dose Area Product")	1	M		Units = EV (Gym2, UCUM, "Gym2")
9	>	CONTAINS	NUM	EV (113738, DCM, "Dose (RP)")	1	M		Units = EV (Gy, UCUM, "Gy")
10	>	CONTAINS	NUM	EV (112011, DCM, "Positioner Primary Angle")	1	UC	XOR Row 14	Units = EV (deg, UCUM, "°")
11	>	CONTAINS	NUM	EV (112012, DCM, "Positioner Secondary Angle")	1	UC	XOR Row 14	Units = EV (deg, UCUM, "°")
12	>	CONTAINS	NUM	EV (113739, DCM, "Positioner Primary End Angle")	1	UC	IFF Row 3 value = (113613, DCM, "Rotational Acquisition")	Units = EV (deg, UCUM, "°")
13	>	CONTAINS	NUM	EV (113740, DCM, "Positioner Secondary End Angle")	1	UC	IFF Row 3 value = (113613, DCM, "Rotational Acquisition")	Units = EV (deg, UCUM, "°")
14	>	CONTAINS	NUM	EV (113770, DCM, "Column Angulation")	1	UC	XOR Rows 10,11	Units = EV (deg, UCUM, "°")
15	>	CONTAINS	NUM	EV (113790, DCM, "Collimated Field Area")	1	U		Units = EV (m2, UCUM, "m^2")

16	>	CONTAINS	CONTAINER	EV (113771, DCM, "X-Ray Filters")	1-n	U		
17	>>	CONTAINS	CODE	EV (113772, DCM, "X-Ray Filter Type")	1	U		DCID (10007) X-Ray Filter Types
18	>>	CONTAINS	CODE	EV (113757, DCM, "X-Ray Filter Material")	1	U		DCID (10006) X-Ray Filter Materials
19	>>	CONTAINS	NUM	EV (113758, DCM, "X-Ray Filter Thickness Minimum")	1	U		Units = EV (mm, UCUM, "mm")
20	>>	CONTAINS	NUM	EV (113773, DCM, "X-Ray Filter Thickness Maximum")	1	U		Units = EV (mm, UCUM, "mm")
21	>	CONTAINS	CODE	EV (113732, DCM, "Fluoro Mode")	1	UC	IFF Row 3 value = (P5-06000, SRT, "Fluoroscopy")	DCID (10004) Fluoro Modes
22	>	CONTAINS	NUM	EV (113791, DCM, "Pulse Rate")	1	MC	IFF Row 21 value = (113631, DCM, "Pulsed")	Units = EV ({pulse}/s, UCUM, "pulse/s")
23	>	CONTAINS	NUM	EV (113768, DCM, "Number of Pulses")	1	M		Units = EV (1, UCUM, "no units")
24	>>	HAS CONCEPT MOD	CODE	EV (121401, DCM, "Derivation")	1	MC	IFF count of pulses in Row 23 is estimated	EV (R-10260, SRT, "Estimated")
25	>	CONTAINS	NUM	EV (113733, DCM, "KVP")	1-n	U		Units = EV (kV, UCUM, "kV")
26	>	CONTAINS	NUM	EV (113734, DCM, "X-Ray Tube Current")	1-n	U		Units = EV (mA, UCUM, "mA")
27	>	CONTAINS	NUM	EV (113735, DCM, "Exposure Time")	1	U		Units = EV (ms, UCUM, "ms")
28	>	CONTAINS	NUM	EV (113793, DCM, "Pulse Width")	1-n	U		Units = EV (ms, UCUM, "ms")
29	>	CONTAINS	NUM	EV (113736, DCM, "Exposure")	1-n	U		Units = EV (uAs, UCUM, "uAs")
30	>	CONTAINS	NUM	EV (113766, DCM, "Focal Spot Size")	1	U		Units = EV (mm, UCUM, "mm")
31	>	CONTAINS	NUM	EV (113742, DCM, "Irradiation Duration")	1	U		Units = EV (s, UCUM, "s")
32	>	CONTAINS	NUM	EV (113767, DCM, "Average X-Ray Tube Current")	1	U		Units = EV (mA, UCUM, "mA")
33	>	CONTAINS	CODE	EV (113745, DCM, "Patient Table Relationship")	1	U		DCID (21) Patient Gantry Relationship
34	>	CONTAINS	CODE	EV (113743, DCM, "Patient Orientation")	1	U		DCID (19) Patient Orientation
35	>>	HAS CONCEPT MOD	CODE	EV (113744, DCM, "Patient Orientation Modifier")	1	M		DCID (20) Patient Orientation Modifier
36	>	CONTAINS	NUM	DCID (10008) Dose Related Distance Measurements	1-n	U		Units = EV (mm, UCUM, "mm")
37	>	CONTAINS	NUM	EV (113754, DCM, "Table Head Tilt Angle")	1	U		Units = EV (deg, UCUM, "°")
38	>	CONTAINS	NUM	EV (113755, DCM, "Table Horizontal Rotation Angle")	1	U		Units = EV (deg, UCUM, "°")

39	>	CONTAINS	NUM	EV (113756, DCM, "Table Cradle Tilt Angle")	1	U		Units = EV (deg, UCUM, "°")
40	>	CONTAINS	CODE	EV (123014 , DCM, ("Target Region"))	1	U		DCID (4031) Common Anatomic Regions
41	>	CONTAINS	TEXT	EV (121106, DCM, "Comment")	1	U		

### Content Item Descriptions

Row 5	Reference Point definition if not provided in TID 10001
Row 6	Reference to Image instances created during this event, if any. The UID reference(s) provided here shall be the values at the time the images were initially created. (Note that image UIDs may be changed as the images are managed over a long term.)
Row 7	If the image generating entity does not assign a DICOM UID to the irradiation event (e.g., for non-digital imaging equipment), the application generating this report shall assign a UID.
Row 9	Dose applied by this irradiation event, relative to defined reference point.
Row 10	Angle in patient's "equatorial" plane (LAO to RAO). For dynamically changing angle during the event, the start value shall be provided. Equivalent to (0018,1510) in an image instance.
Row 11	Angle in patient's "sagittal" plane (CRAN to CAUD). For dynamically changing angle during the event, the start value shall be provided. Equivalent to (0018,1511) in an image instance.
Row 12	In case of motion during irradiation event, Positioner Primary ending angle
Row 13	In case of motion during irradiation event., Positioner Secondary ending angle
Row 14	Column device Angle in equipment based coordinates
Row 15	Collimated area at the receptor plane.
Row 16	If one or more Filter(s) were applied during this irradiation event
Row 23	If a precise count of pulses is not available, an estimated number shall be provided, and the Row 24 Concept Modifier shall indicate "Estimated"
Row 25	KVP value as measured/recorded by system, either as a single mean value, or as multiple values. If multiple values are provided, their number shall match the value in Row 23 "Number of Pulses".
Row 26	Tube current as measured/recorded by system, either as a single mean value, or as multiple values. If multiple values are provided, their number shall match the value in Row 23 "Number of Pulses".
Row 27	Exposure time as measured/recorded by the system.
Row 28	Pulse width as measured/recorded by the system, either as a single total value, or as multiple values. If multiple values are provided, their number shall match the value in Row 23 "Number of Pulses".
Row 29	Exposure as measured/recorded by system, either as a single total value, or as multiple values. If multiple values are provided, their number shall match the value in Row 23 "Number of Pulses". The Exposure will be affected by the shape of the pulse and other factors, and may not be a simple multiplication of tube current and exposure time.
Row 40	The target region is the anatomy exposed.

**Annex B DCMR Context Groups (Normative)**

This Annex specifies the content of Context Groups required by DICOM IODs.

Note: Section 7.1 of this Part defines the fields of Context Group tables.

**CID 2 Anatomic Modifier**

**Context ID 2  
Anatomic Modifier**

**Type: Extensible Version: 20020904**

<b>Coding Scheme Designator (0008,0102)</b>	<b>Code Value (0008,0100)</b>	<b>Code Meaning (0008,0104)</b>
SNM3	G-A100	Right
SNM3	G-A101	Left
SNM3	G-A102	Bilateral
SNM3	G-A103	Unilateral
SNM3	G-A104	Lateral
SNM3	G-A105	Anterior
SNM3	G-A106	Posterior
SNM3	G-A107	Cephalic
SNM3	G-A108	Caudal
SNM3	G-A109	Medial
SNM3	G-A110	Central
SNM3	G-A111	Peripheral
SNM3	G-A112	External
SNM3	G-A113	Internal
SNM3	G-A114	Intermediate
SNM3	G-A115	Inferior
SNM3	G-A116	Superior
SNM3	G-A117	Transverse
SNM3	G-A118	Proximal
SNM3	G-A119	Distal
SNM3	G-A120	Postaxial
SNM3	G-A121	Preaxial
SNM3	G-A122	Apical
SNM3	G-A123	Basal
SNM3	G-A127	Afferent
SNM3	G-A128	Efferent
SNM3	G-A138	Coronal
SNM3	G-A139	Superficial

SNM3	G-A140	Deep
SNM3	G-A142	Horizontal
SNM3	G-A143	Longitudinal
SNM3	G-A144	Vertical
SNM3	G-A145	Sagittal
SNM3	G-A147	Axial
SNM3	G-A151	Extra-articular
SNM3	G-A168	Surface
SNM3	G-A169	Gutter
SNM3	G-A170	Hilar
SNM3	G-A171	Capsular
SNM3	G-A172	Subcapsular
SNM3	G-A174	Edge
SNM3	G-A180	Anterolateral
SNM3	G-A182	Posterolateral
SNM3	G-A15A	Intra-articular
SNM3	G-A428	Marginal

**CID 4 Anatomic Region**

**Context ID 4**

**Anatomic Region**

**Type: Extensible Version: 20061023**

<b>Coding Scheme Designator (0008,0102)</b>	<b>Code Value (0008,0100)</b>	<b>Code Meaning (0008,0104)</b>
<i>INCLUDE CID 4030 CT and MR Anatomy Imaged</i>		
<i>NCLUDE CID 4040 Endoscopy Anatomic Regions</i>		
<i>NCLUDE CID 4042 XA/XRF Anatomy Imaged</i>		
SNM3	T-32100	Atrium
SNM3	T-D8100	Axilla
SNM3	T-D2100	Back
SNM3	T-D6500	Broad ligament
SNM3	T-D1206	Buccal region of face
SNM3	T-D2600	Buttock
SNM3	T-72100	Calyx
SNM3	T-D1206	Cheek
SNM3	T-AA200	Cornea
SNM3	T-AB000	Ear
SNM3	T-41000	Endo-arterial
SNM3	T-32000	Endo-cardiac



SNM3	T-56000	Endo-esophageal
SNM3	T-21300	Endo-nasal
SNM3	T-23050	Endo-nasopharyngeal
SNM3	T-59600	Endo-rectal
SNM3	T-71000	Endo-renal
SNM3	T-73000	Endo-ureteric
SNM3	T-75000	Endo-urethral
SNM3	T-82000	Endo-vaginal
SNM3	T-40000	Endo-vascular
SNM3	T-48000	Endo-venous
SNM3	T-74250	Endo-vesical
SNM3	T-D4200	Epigastric region
SNM3	T-AA810	Eyelid
SNM3	T-D1200	Face
SNM3	T-D2310	Flank
SNM3	T-15200	Fontanel of skull
SNM3	T-D2600	Gluteal region
SNM3	T-D2500	Hip
SNM3	T-D4240	Hypogastric region
SNM3	T-D1212	Hypoglossal
SNM3	T-55300	Hypopharynx
SNM3	T-D4010	Intra-abdominal
SNM3	G-A15A	Intra-articular
SNM3	T-D14000	Intracranial
SNM3	T-56000	Intra-esophageal
SNM3	T-D6221	Intra-pelvic
SNM3	T-D3000	Intra-thoracic
SNM3	T-D4211	Left hypochondriac region
SNM3	T-D7020	Left inguinal region
SNM3	T-D4140	Left lower quadrant of abdomen
SNM3	T-D2340	Left lumbar region
SNM3	T-D4130	Left upper quadrant of abdomen
SNM3	T-04003	Lower inner quadrant of breast
SNM3	T-04005	Lower outer quadrant of breast
SNM3	T-D2300	Lumbar region
SNM3	T-28000	Lung
SNM3	T-51000	Mouth
SNM3	T-21000	Nose
SNM3	T-D4450	Omental bursa
SNM3	T-D4600	Omentum
SNM3	T-87000	Ovary
SNM3	T-65010	Pancreatic duct

SNM3	T-D3136	Parasternal
SNM3	T-91000	Penis
SNM3	T-D2700	Perineum
SNM3	T-D9310	Popliteal fossa
SNM3	T-72000	Renal pelvis
SNM3	T-D4900	Retroperitoneum
SNM3	T-D4212	Right hypochondriac region
SNM3	T-D7010	Right inguinal region
SNM3	T-D4120	Right lower quadrant of abdomen
SNM3	T-D2342	Right lumbar region
SNM3	T-D4110	Right upper quadrant of abdomen
SNM3	T-D1160	Scalp
SNM3	T-AA110	Sclera
SNM3	T-98000	Scrotum
SNM3	T-A7010	Spinal cord
SNM3	T-D4210	Subcostal
SNM3	T-D1603	Submandibular area
SNM3	T-D3213	Subxiphoid
SNM3	T-D1620	Supraclavicular region of neck
SNM3	T-D4240	Suprapubic region
SNM3	T-11218	Suprasternal notch
SNM3	T-D9100	Thigh
SNM3	T-D3000	Thorax
SNM3	T-53000	Tongue
SNM3	T-D4230	Umbilical region
SNM3	T-04002	Upper inner quadrant of breast
SNM3	T-04004	Upper outer quadrant of breast
SNM3	T-82000	Vagina
SNM3	A-04140	Vascular graft
SNM3	T-32400	Ventricle
SNM3	T-81000	Vulva
SNM3	T-15460	Wrist joint

**CID 5 Transducer Approach**

**Context ID 5**

**Transducer Approach**

**Type: Extensible Version: 20061024**

<b>Coding Scheme Designator (0008,0102)</b>	<b>Code Value (0008,0100)</b>	<b>Code Meaning (0008,0104)</b>
SNM3	G-A100	Right
SNM3	G-A101	Left

SNM3	G-A104	Lateral
SNM3	G-A105	Anterior
SNM3	G-A106	Posterior
SNM3	G-A108	Caudal
SNM3	G-A109	Medial
SNM3	G-A110	Central
SNM3	G-A111	Peripheral
SNM3	G-A112	External
SNM3	G-A113	Internal
SNM3	G-A115	Inferior
SNM3	G-A116	Superior
SNM3	G-A117	Transverse
SNM3	G-A118	Proximal
SNM3	G-A119	Distal
SNM3	G-A122	Apical
SNM3	G-A168	Surface
SNM3	G-A599	Ascending
SNM3	G-A600	Descending
SNM3	T-03000	Subcutaneous tissue
SNM3	T-A1120	Dura mater
SNM3	T-A1280	Pia mater
SNM3	A-2C600	External prosthesis for sonographic procedure [Stand-off]
SNM3	A-2C602	Water bag prosthesis for imaging procedure
SNM3	A-2C604	Saline bag prosthesis for imaging procedure
SNM3	A-2C606	Gel prosthesis for imaging procedure
SNM3	G-A107	Cranial
SNM3	G-A10A	Midline
SNM3	G-A188	Mid-longitudinal
SNM3	G-A189	Parasagittal
SNM3	R-42142	Intraluminal
SNM3	G-A171	Capsular
SNM3	T-D0048	Lumen
SNM3	G-4022	Contact with
SNM3	T-D0062	Parenchyma

Note: In a prior version of this Context Group, the codes G-A11A, G-A11B, G-A12A, G-A16A, G-A16B, G-A16C, and G-A16D were specified for various concepts. The use of some of those codes conflicts with their assignment to other concepts in SNOMED, and their use in this context is deprecated. Although there is minimal possibility of misinterpretation with SOP Instances that may include the deprecated use, receiving applications should be aware of this change; see Annex J.

**CID 6 Transducer Orientation**

**Context ID 6**

**Transducer Orientation**

**Type: Extensible Version: 20040322**

<b>Coding Scheme Designator (0008,0102)</b>	<b>Code Value (0008,0100)</b>	<b>Code Meaning (0008,0104)</b>
SNM3	G-A138	Coronal
SNM3	G-A143	Longitudinal
SNM3	G-A145	Sagittal
SNM3	G-A189	Parasagittal
SNM3	G-A472	Oblique
SNM3	G-A185	Long axis
SNM3	G-A13B	Off axis
SNM3	G-A186	Short axis
SNM3	G-A191	Five chamber
SNM3	G-A19B	Two chamber
SNM3	G-A19C	Four chamber
SNM3	G-A117	Transverse

Note: In a prior version of this table, the code G-A11B was specified for the concept Parasagittal. The use of this code conflicts with its assignment to another concept in SNOMED, and its use in this context is deprecated. Although there is minimal possibility of misinterpretation with SOP Instances that may include the deprecated use, receiving applications should be aware of this change; see Annex J.

**CID 7 Ultrasound Beam Path**

**Context ID 7**

**Ultrasound Beam Path**

**Type: Extensible Version: 20020904**

<b>Coding Scheme Designator (0008,0102)</b>	<b>Code Value (0008,0100)</b>	<b>Code Meaning (0008,0104)</b>
SNM3	G-A1A9	Trans-hepatic
SNM3	G-A1B2	Trans-gastric
SNM3	G-A1A5	Trans-pleural
SNM3	G-A1B3	Trans-mural
SNM3	G-A1A8	Trans-orbital
SNM3	G-A1A6	Trans-pancreatic
SNM3	G-A1A4	Trans-renal
SNM3	G-D032	Trans-temporal
SNM3	G-A1A2	Trans-theical
SNM3	G-A1A1	Trans-vesical
SNM3	G-A1A3	Trans-splenic

SNM3	G-D033	Trans-esophageal
SNM3	G-D001	Trans-abdominal
SNM3	G-D002	Trans-vaginal (endovaginal)

**CID 8 Angiographic Interventional Devices**

**Context ID 8**

**Angiographic Interventional Devices**

**Type: Extensible Version: 20020904**

<b>Coding Scheme Designator (0008,0102)</b>	<b>Code Value (0008,0100)</b>	<b>Code Meaning (0008,0104)</b>
SNM3	A-25500	Stent
SNM3	A-26800	Catheter
SNM3	A-81080	Laser
SNM3	C-20005	Glue
SNM3	A-25600	Atherectomy device
SNM3	A-25614	Embolization ball
SNM3	A-26912	Percutaneous transluminal angioplasty balloon
SNM3	A-25612	Embolization coil
SNM3	A-25612	Gianturco coil
SNM3	A-27322	Detachable balloon
SNM3	A-26A06	Fixed object
SNM3	A-26A08	Grid
SNM3	A-26802	Guiding catheter
SNM3	A-25616	Embolization particulate
SNM3	A-25610	Rotational atherectomy device
SNM3	A-10141	Measuring ruler
DCM	122485	Sphere

**CID 9 Image Guided Therapeutic Procedures**

**Context ID 9**

**Image Guided Therapeutic Procedures**

**Type: Extensible Version: 20020904**

<b>Coding Scheme Designator (0008,0102)</b>	<b>Code Value (0008,0100)</b>	<b>Code Meaning (0008,0104)</b>
SNM3	F-39780	Vasoconstriction
SNM3	F-39800	Vasodilatation
SNM3	P1-03100	Biopsy
SNM3	P1-03176	Removal of foreign body
SNM3	P1-05035	Intra-arterial infusion of thrombolytic agent

SNM3	P1-05052	Irrigation following insertion of catheter
SNM3	P1-05535	Catheterization
SNM3	P1-30350	Atherectomy
SNM3	P1-30351	Atherectomy by rotary cutter
SNM3	P1-30352	Atherectomy by laser
SNM3	P1-30530	Selective embolization of artery
SNM3	P5-31500	Percutaneous transluminal balloon angioplasty
SNM3	P5-39010	Transcatheter therapy for embolization
SNM3	P5-39050	Percutaneous retrieval of intravascular foreign body
SNM3	P1-00018	Failed attempted procedure
SNM3	P1-05550	Stent placement
SNM3	P1-05536	Catheter manipulation
SNM3	P1-05537	Catheter replacement
SNM3	P1-05538	Occlusion of catheter
SNM3	P1-05539	Removal of catheter
SNM3	P5-39015	Transcatheter deployment of detachable balloon
SNM3	P5-39191	Percutaneous insertion of intravascular filter
SNM3	P1-86100	Amniocentesis
SNM3	P5-B8310	Ultrasonic guidance for amniocentesis
SNM3	P1-86520	Amnioinfusion [injection of amnion]
SNM3	P1-86180	Intrauterine cordocentesis
SNM3	P1-28160	Thoracentesis
SNM3	P1-86E70	Breech Version [Obstetrical Version]
SRT	P1-86101	Decompression amniocentesis [decompression of amnion]
SNM3	P2-68060	Intrauterine transfusion
SRT	P1-86C50	Fetocide (selective reduction)
SRT	P1-93506	Prostaglandin injection

**CID 10 Interventional Drug**

**Context ID 10**

**Interventional Drug**

**Type: Extensible Version: 20020904**

<b>Coding Scheme Designator (0008,0102)</b>	<b>Code Value (0008,0100)</b>	<b>Code Meaning (0008,0104)</b>
SNM3	C-21005	Ethanol
SNM3	C-22947	Methylene blue
SNM3	C-51000	Antihistamine
SNM3	C-67770	Atropine

SNM3	C-72000	Diuretic
SNM3	C-80110	Antiarrhythmic drug
SNM3	C-80120	Inotropic agent
SNM3	C-80123	Cardiotonic drug
SNM3	C-80125	Cardiac depressant drug
SNM3	C-80130	Cardiac adrenergic blocking agent
SNM3	C-80131	Alpha-adrenergic blocking agent
SNM3	C-80135	beta-Adrenergic blocking agent
SNM3	C-80330	Digoxin
SNM3	C-80400	Lidocaine
SNM3	C-80401	Lidocaine hydrochloride
SNM3	C-80430	Nifedipine
SNM3	C-80450	Propranolol
SNM3	C-80460	Quinidine
SNM3	C-80490	Verapamil
SNM3	C-81100	Hypotensive agent
SNM3	C-81120	Centrally acting hypotensive agent
SNM3	C-81560	Nitroglycerin
SNM3	C-A2010	Glucagon preparation
SNM3	C-A6500	Anticoagulant
SNM3	C-A6530	Warfarin
SNM3	C-A6540	Heparin
SNM3	C-A6700	Anti-heparin agent
SNM3	C-A6710	Protamine sulfate
SNM3	C-A6900	Coagulant
SNM3	C-A6920	Injectable fibrinogen
SNM3	C-A7000	Hemostatic agent
SNM3	C-A7001	Astringent drug
SNM3	C-A7021	Antihemophilic factor preparation
SNM3	C-A7040	Thrombin preparation
SNM3	C-A7042	Thromboplastin preparation
SNM3	C-A7220	Dextran
SNM3	C-A7400	Thrombolytic agent
SNM3	C-A7420	Streptokinase preparation
SNM3	C-A7430	Urokinase preparation
SNM3	C-A7440	Injectable fibrinolysin
SNM3	C-C2318	Priscoline hydrochloride ampuls
SNM3	F-B2110	Epinephrine

**CID 11 Route of Administration**

**Context ID 11  
Route of Administration**

**Type: Extensible Version: 20020904**

<b>Coding Scheme Designator (0008,0102)</b>	<b>Code Value (0008,0100)</b>	<b>Code Meaning (0008,0104)</b>
SNM3	G-D101	Intravenous route
SNM3	G-D102	Intra-arterial route
SNM3	G-D103	Intramuscular route
SNM3	G-D104	Subcutaneous route
SNM3	G-D105	Intracutaneous route
SNM3	G-D106	Intraperitoneal route
SNM3	G-D107	Intramedullary route
SNM3	G-D108	Intrathecal route
SNM3	G-D109	Intra-articular route
SNM3	G-D111	Intraepithelial route
SNM3	G-D112	Topical route
SNM3	G-D140	Oral route
SNM3	G-D142	Transluminal route
SNM3	G-D144	Intraluminal route
SNM3	G-D146	Extraluminal route
SNM3	G-D150	By inhalation
SNM3	G-D160	Per rectum
SNM3	G-D164	Vaginal route

**CID 12 Radiographic Contrast Agent**

**Context ID 12  
Radiographic Contrast Agent**

**Type: Extensible Version: 20051101**

<b>Coding Scheme Designator (0008,0102)</b>	<b>Code Value (0008,0100)</b>	<b>Code Meaning (0008,0104)</b>	<b>Trade Name (Informative)</b> (From <a href="http://www.accessdata.fda.gov/scripts/cder/drugsatfda/index.cfm">http://www.accessdata.fda.gov/scripts/cder/drugsatfda/index.cfm</a> )
SNM3	A-80230	Air	
SNM3	C-10110	Oxygen	
SNM3	C-10120	Water	
SNM3	C-10520	Carbon dioxide	
SNM3	C-12217	Barium Sulfate	
SNM3	C-17800	Gadolinium	
SNM3	C-B0300	Contrast agent	
SNM3	C-B0310	Radiopaque medium	



SNM3	C-B0312	Non radiopaque medium	
SNM3	C-B0315	Bunamiodyl	
SNM3	C-B0316	Chloriodized oil	
SNM3	C-B0317	Diatrizoate	Angiovist™ (Berlex), Cardiografin™ (Bracco), Cystografin™ (Bracco), Gastrografen™ (Bracco), Gastrovist™ (Berlex), Hypaque™ (GE), MD-nn™ (Mallinckrodt), Reno-nn™ (Bracco), Renografin™ (Bracco), Renovist™ (Bracco), Sinografin™ (Bracco), Urovist™ (Berlex)
SNM3	C-B0318	Iodipamide	Cholographin™ (Bracco), Sinografin™ (Bracco)
SNM3	C-B0319	Iodized oil	
SNM3	C-B0323	Iodoalphonic acid	
SNM3	C-B0324	Meglumine iodipamide	Cholographin Meglumine™ (Bracco)
SNM3	C-B0325	Sodium iodipamide	Cholographin Sodium™ (Bracco)
SNM3	C-B0326	Iodamide meglumine	Renovue™ (Bracco)
SNM3	C-B0327	Iodopyracet	
SNM3	C-B0328	Iopanoic acid	Telepaque™ (GE)
SNM3	C-B0331	Iophendylate	Pantopaque™ (Alcon)
SNM3	C-B0333	Iophenoxic acid	
SNM3	C-B0335	Ipodate	Bilivist™ (Berlex), Oragrafin™ (Bracco)
SNM3	C-B0337	Propyliodone	Dionosil™ (GSK)
SNM3	C-B0338	Sodium acetrizoate	Salpix™ (Ortho)
SNM3	C-B0341	Iodophthalein	
SNM3	C-B0342	Sodium diprotrizoate	
SNM3	C-B0344	Sodium iodomethamate	
SNM3	C-B0345	Meglumine diatrizoate	Angiovist™ (Berlex), Cardiografin™ (Bracco), Cystografin™ (Bracco), Gastrografen™ (Bracco), Gastrovist™ (Berlex), Hypaque™ (GE), MD-nn™ (Mallinckrodt), Reno-nn™ (Bracco), Renografin™ (Bracco), Renovist™ (Bracco), Sinografin™ (Bracco), Urovist™ (Berlex)
SNM3	C-B0347	Sodium diatrizoate	Angiovist™ (Berlex), Gastrografen™ (Bracco), Gastrovist™ (Berlex), Hypaque™ (GE), MD-nn™ (Mallinckrodt), Renografin™ (Bracco), Renovist™ (Bracco), Urovist™ (Berlex)
SNM3	C-B0348	Metrizamide	Amipaque™ (GE)
SNM3	C-B0349	Sodium tyropanate	
SNM3	C-B0301	Ionic iodinated contrast agent	

SNM3	C-B0302	Non-ionic iodinated contrast agent	
SRT	C-B0322	Iohexol	Omnipaque™(GE)
SRT	C-B03BC	Iodixanol	Visipaque™(GE)
SRT	C-B03C3	Gadodiamide	Omniscan™(GE)
SRT	C-B05A3	Mangafodipir trisodium	Teslascan™(GE)
SRT	C-B038B	Iothalamate	Conray™ (Mallinckrodt), Cysto-Conray™ (Mallinckrodt), Vascoray™ (Mallinckrodt)
SRT	C-B0339	Ioxaglate	Hexbrix™ (Mallinckrodt)
SRT	C-B03C9	Metrizoate	Isopaque™ (GE)
SRT	C-B03AA	Dimeglumine gadopentetate	Magnevist™ (Berlex)
SRT	C-B0329	Iopamidol	Isovue™ (Bracco)
SRT	C-B0332	Ioversol	Optiray™ (Mallinckrodt)

Note: The codes drawn from SNOMED are recommended to be those from the concept hierarchy of “radiographic contrast media” in the hierarchy “pharmaceutical/biological product”, and secondarily from the hierarchy “substance”.

### CID 13 Radiographic Contrast Agent Ingredient

#### Context ID 13

#### Radiographic Contrast Agent Ingredient

Type: Extensible Version: 20051101

Coding Scheme Designator (0008,0102)	Code Value (0008,0100)	Code Meaning (0008,0104)
SRT	C-11400	Iodine
SRT	C-17800	Gadolinium
SRT	C-10520	Carbon Dioxide
SRT	C-12200	Barium
SRT	C-17200	Xenon
SRT	A-80230	Air
SRT	C-10110	Oxygen
SRT	C-10120	Water
SRT	C-130F9	Iron

### CID 18 Isotopes in Radiopharmaceuticals

#### Context ID 18

#### Isotopes in Radiopharmaceuticals

Type: Extensible Version: 20020904

Coding Scheme Designator (0008,0102)	Code Value (0008,0100)	Code Meaning (0008,0104)
SNM3	C-111A1	<sup>18</sup> F Fluorine

SNM3	C-114A4	^123^Iodine
SNM3	C-114A6	^125^Iodine
SNM3	C-114B1	^131^Iodine
SNM3	C-122A5	^133^Barium
SNM3	C-131A2	^67^Gallium
SNM3	C-138A9	^201^Thallium
SNM3	C-144A3	^57^Cobalt
SNM3	C-145A4	^111^Indium
SNM3	C-163A8	^99m^Technetium
SNM3	C-172A8	^133^Xenon
SNM3	C-173A7	^85^Krypton
SNM3	C-178A8	^153^Gadolinium

**CID 19 Patient Orientation**

**Context ID 19**

**Patient Orientation**

Type: Extensible Version: 20020904

Coding Scheme Designator (0008,0102)	Code Value (0008,0100)	Code Meaning (0008,0104)
SNM3	F-10440	erect
SNM3	F-10450	recumbent
SNM3	F-10460	semi-erect

**CID 20 Patient Orientation Modifier**

**Context ID 20**

**Patient Orientation Modifier**

Type: Extensible Version: 20020904

Coding Scheme Designator (0008,0102)	Code Value (0008,0100)	Code Meaning (0008,0104)
SNM3	F-10310	prone
SNM3	F-10316	semi-prone
SNM3	F-10318	lateral decubitus
SNM3	F-10320	standing
SNM3	F-10326	anatomical
SNM3	F-10330	kneeling
SNM3	F-10336	knee-chest
SNM3	F-10340	supine
SNM3	F-10346	lithotomy
SNM3	F-10348	Trendelenburg

SNM3	F-10349	inverse Trendelenburg
SNM3	F-10380	frog
SNM3	F-10390	stooped-over
SNM3	F-103A0	sitting
SNM3	F-10410	curled-up
SNM3	F-10317	right lateral decubitus
SNM3	F-10319	left lateral decubitus

**CID 21 Patient Gantry Relationship**

**Context ID 21**

**Patient Gantry Relationship**

Type: Extensible Version: 20040322

Coding Scheme Designator (0008,0102)	Code Value (0008,0100)	Code Meaning (0008,0104)
SNM3	R-10516	oblique
SNM3	F-10470	headfirst
SNM3	F-10480	feet-first
SNM3	R-10515	transverse

- Notes:
1. The use of this Context Group in the Patient Orientation Modifier Code Sequence (0054,0412) of the NM Image IOD and the PET Image IOD (see PS3.3) requires a Coding Scheme Designator value of "99SDM".
  2. In a prior version of this Context Group, the codes G-5190 and G-5191 were specified for the concepts "headfirst" and "feet-first". The use of these codes is deprecated as they are not actually in SNOMED. Although there is minimal possibility of misinterpretation with SOP Instances that may include the deprecated use, receiving applications should be aware of this change; see Annex J.

**CID 23 Cranio-caudad Angulation**

**Context ID 23**

**Cranio-caudad Angulation**

Type: Extensible Version: 20020904

Coding Scheme Designator (0008,0102)	Code Value (0008,0100)	Code Meaning (0008,0104)
SNM3	G-A107	Cephalic
SNM3	G-A108	Caudal

CID 25 Radiopharmaceuticals

Context ID 25  
Radiopharmaceuticals

Type: Extensible Version: 20020904

Coding Scheme Designator (0008,0102)	Code Value (0008,0100)	Code Meaning (0008,0104)
SNM3	C-B1302	Carbon <sup>14</sup> D-xylose
SNM3	C-B1300	Carbon <sup>14</sup> triolein
SNM3	C-B1304	Cholyl-carbon <sup>14</sup> glycine
SNM3	C-B1140	Chromic phosphate P <sup>32</sup>
SNM3	C-B1012	Chromium <sup>51</sup> albumin
SNM3	C-B1013	Chromium <sup>51</sup> chloride
SNM3	C-B1051	Colloidal gold Au <sup>198</sup>
SNM3	C-B1063	Colloidal Indium <sup>111</sup>
SNM3	C-B1017	Copper <sup>64</sup> acetate
SNM3	C-B1016	Copper <sup>64</sup> versenate
SNM3	C-B1018	Copper <sup>67</sup> ceruloplasmin
SNM3	C-B1021	Cyanocobalamin Co <sup>57</sup>
SNM3	C-B1022	Cyanocobalamin Co <sup>58</sup>
SNM3	C-B1023	Cyanocobalamin Co <sup>60</sup>
SNM3	C-B1000	Diagnostic radioisotope
SNM3	C-B1092	Diiodofluorecein I <sup>131</sup>
SNM3	C-B1062	Disodium indium <sup>111</sup>
SNM3	C-B1122	Ferrous chloride Fe <sup>59</sup>
SNM3	C-B1121	Ferrous citrate Fe <sup>59</sup>
SNM3	C-B1123	Ferrous sulfate Fe <sup>59</sup>
SNM3	C-B1082	Fibrinogen I <sup>123</sup>
SNM3	C-B1031	Fluorodeoxyglucose F <sup>18</sup>
SNM3	C-B1041	Gallium <sup>67</sup> citrate
SNM3	C-B1061	Indium <sup>111</sup> pentetate
SNM3	C-B1066	Indium <sup>111</sup> red cell label
SNM3	C-B1067	Indium <sup>111</sup> transferrin
SNM3	C-B1065	Indium <sup>111</sup> -Fe(OH) <sub>3</sub>
SNM3	C-B1068	Indium <sup>113</sup> bleomycin
SNM3	C-B1069	Indium <sup>113</sup> chloride
SNM3	C-B1072	Indium <sup>113</sup> oxoquinoline platelet label
SNM3	C-B1073	Indium <sup>113</sup> oxoquinoline RBC label
SNM3	C-B1071	Indium <sup>113</sup> oxoquinoline WBC label
SNM3	C-B1070	Indium <sup>113</sup> pentetate
SNM3	C-B1084	Iodinated I <sup>125</sup> albumin
SNM3	C-B1100	Iodinated I <sup>125</sup> human serum albumin

SNM3	C-B1094	Iodinated I <sup>125</sup> levothyroxine
SNM3	C-B1093	Iodinated I <sup>125</sup> oleic acid and triolein
SNM3	C-B1096	Iodinated I <sup>125</sup> povidone
SNM3	C-B1097	Iodinated I <sup>125</sup> Rose Bengal
SNM3	C-B1098	Iodinated I <sup>125</sup> sealed source
SNM3	C-B1099	Iodinated I <sup>125</sup> sodium iodine
SNM3	C-B1090	Iodinated I <sup>131</sup> aggregated albumin
SNM3	C-B1089	Iodinated I <sup>131</sup> albumin
SNM3	C-B1111	Iodinated I <sup>131</sup> gamma globulin
SNM3	C-B1109	Iodine <sup>131</sup> polyvinylpyrrolidone
SNM3	C-B1087	Iodocholesterol I <sup>131</sup>
SNM3	C-B1095	Iodohippurate I <sup>123</sup> sodium
SNM3	C-B1105	Iodohippurate I <sup>125</sup> sodium
SNM3	C-B1091	Iodohippurate I <sup>131</sup> sodium
SNM3	C-B1108	Iofetamine I <sup>123</sup> hydrochloride
SNM3	C-B1088	Iothalamate sodium I <sup>125</sup>
SNM3	C-B1124	Iron Fe <sup>59</sup> labeled dextran
SNM3	C-B1083	Oleic acid I <sup>125</sup>
SNM3	C-B1251	Pentetate calcium trisodium Yb <sup>169</sup>
SNM3	C-B1151	Potassium carbonate K <sup>42</sup>
SNM3	C-B1152	Potassium chloride K <sup>42</sup>
SNM3	C-B1150	Potassium chloride K <sup>43</sup>
SNM3	C-B1085	Rose Bengal sodium I <sup>131</sup>
SNM3	C-B1172	Selenium <sup>75</sup> HCAT
SNM3	C-B1171	Selenomethionione Se <sup>75</sup>
SNM3	C-B1176	Sodium chloride Na <sup>22</sup>
SNM3	C-B1175	Sodium chloride Na <sup>24</sup>
SNM3	C-B1011	Sodium chromate Cr <sup>51</sup>
SNM3	C-B1032	Sodium fluoride F <sup>18</sup>
SNM3	C-B1081	Sodium iodide I <sup>123</sup>
SNM3	C-B1086	Sodium iodide I <sup>131</sup>
SNM3	C-B1206	Sodium pertechnetate Tc <sup>99m</sup>
SNM3	C-B1142	Sodium phosphate P <sup>32</sup>
SNM3	C-B1180	Strontium chloride Sr <sup>85</sup>
SNM3	C-B1181	Strontium chloride Sr <sup>87</sup>
SNM3	C-B1182	Strontium nitrate Sr <sup>85</sup>
SNM3	C-B1183	Strontium nitrate Sr <sup>87</sup>
SNM3	C-B1225	Technetium Tc <sup>99</sup> N-substituted iminodiacetate
SNM3	C-B1224	Technetium Tc <sup>99</sup> tagged red cells
SNM3	C-B1205	Technetium Tc <sup>99c</sup> albumin microspheres
SNM3	C-B1207	Technetium Tc <sup>99c</sup> disofenin

SNM3	C-B1223	Technetium Tc <sup>99c</sup> exametazine
SNM3	C-B1210	Technetium Tc <sup>99c</sup> iron ascorbate
SNM3	C-B1209	Technetium Tc <sup>99c</sup> lidofenin
SNM3	C-B1208	Technetium Tc <sup>99c</sup> mebrofenin
SNM3	C-B1212	Technetium Tc <sup>99c</sup> medronate
SNM3	C-B1213	Technetium Tc <sup>99c</sup> oxidronate
SNM3	C-B1214	Technetium Tc <sup>99c</sup> pentetate
SNM3	C-B1215	Technetium Tc <sup>99c</sup> pyro and polyphosphates
SNM3	C-B1216	Technetium Tc <sup>99c</sup> serum albumin
SNM3	C-B1220	Technetium Tc <sup>99c</sup> sodium glucoheptonate
SNM3	C-B1211	Technetium Tc <sup>99c</sup> stannous etidronate
SNM3	C-B1221	Technetium Tc <sup>99c</sup> succimer
SNM3	C-B1222	Technetium Tc <sup>99c</sup> sulfur colloid
SNM3	C-B1200	Technetium Tc <sup>99m</sup> aggregated albumin
SNM3	C-B1204	Technetium Tc <sup>99m</sup> albumin colloid
SNM3	C-B1203	Technetium Tc <sup>99m</sup> microaggregated albumin
SNM3	C-B1231	Thallous chloride Tl <sup>201</sup>
SNM3	C-B1010	Therapeutic radioisotope
SNM3	C-B1251	Yb <sup>169</sup> -DTPA - pentetate

**CID 26 Nuclear Medicine Projections**

**Context ID 26**

**Nuclear Medicine Projections**

Type: Extensible Version: 20040322

<b>Coding Scheme Designator (0008,0102)</b>	<b>Code Value (0008,0100)</b>	<b>Code Meaning (0008,0104)</b>
SNM3	G-A138	Coronal
SNM3	G-A145	Sagittal
SNM3	G-A147	Axial
SNM3	G-5206	Right anterior oblique
SNM3	G-5207	Left anterior oblique
SNM3	G-5208	Right posterior oblique
SNM3	G-5209	Left posterior oblique
SNM3	G-5210	Oblique axial
SNM3	G-5212	Sagittal-oblique axial
SNM3	G-5220	Medial-lateral
SNM3	G-5221	Lateral-medial
SNM3	G-5222	Right lateral projection
SNM3	G-5223	Left lateral projection

SNM3	G-5224	Medio-lateral oblique
SNM3	G-5225	Latero-medial oblique
SNM3	G-A117	Transverse
SNM3	G-A104	Lateral
SNM3	G-A186	Short Axis
SNM3	G-A18A	Vertical Long Axis
SNM3	G-A18B	Horizontal Long Axis
SNM3	G-5215	Anterior projection
SNM3	G-5216	Posterior projection

- Notes:
1. In a prior version of this table, the code G-A117 was specified for the concept Transaxial, and R-11300 was specified for the concept Transverse. Since these concepts are synonymous in nuclear projections, and since SNOMED assigns G-A117 to the concept Transverse, the use of R-11300 is deprecated. Although there is minimal possibility of misinterpretation with SOP Instances that may include the deprecated use, receiving applications should be aware of this change; see Annex J.
  2. The following Code Values were formerly included in CID 26 and are retired:

Coding Scheme Designator (0008,0102)	Code Value (0008,0100)	Code Meaning (0008,0104)
SNM3	G-5200	<i>Antero-posterior</i>
SNM3	G-5201	<i>Postero-anterior</i>
SNM3	G-5203	<i>Frontal oblique</i>
SNM3	G-5204	<i>Antero-posterior Oblique</i>
SNM3	G-5205	<i>Postero-anterior Oblique</i>
SNM3	G-5211	<i>Frontal-oblique axial</i>
SNM3	G-5213	<i>Submento-vertex axial</i>
SNM3	G-5214	<i>Oblique submento-vertex</i>
SNM3	G-5226	<i>Right to left oblique</i>
SNM3	G-5227	<i>Left to right oblique</i>

### CID 29 Acquisition Modality

This Context Group includes codes that may be used to identify an image or waveform acquisition modality, as used in Attribute Modality (0008,0060) of a Composite SOP Instance Series Module (see PS3.3). It generally corresponds to a class of diagnostic equipment, or to a specific acquisition function or technique in a device.

**Context ID 29**  
**Acquisition Modality**  
**Type: Extensible Version: 20061023**

Coding Scheme Designator	Code Value	Code Meaning
DCM	EPS	Cardiac Electrophysiology
DCM	CR	Computed Radiography



DCM	CT	Computed Tomography
DCM	DX	Digital Radiography
DCM	ECG	Electrocardiography
DCM	ES	Endoscopy
DCM	XC	External-camera Photography
DCM	GM	General Microscopy
DCM	HD	Hemodynamic Waveform
DCM	IO	Intra-oral Radiography
DCM	IVUS	Intravascular Ultrasound
DCM	MR	Magnetic Resonance
DCM	MG	Mammography
DCM	NM	Nuclear Medicine
DCM	OCT	Optical Coherence Tomography
DCM	OPM	Ophthalmic Mapping
DCM	OP	Ophthalmic Photography
DCM	OPR	Ophthalmic Refraction
DCM	OPV	Ophthalmic Visual Field
DCM	PX	Panoramic X-Ray
DCM	PT	Positron emission tomography
DCM	RF	Radiofluoroscopy
DCM	RG	Radiographic imaging
DCM	RTIMAGE	Radiotherapy Image
DCM	REG	Registration
DCM	SEG	Segmentation
DCM	SM	Slide Microscopy
DCM	US	Ultrasound
DCM	XA	X-Ray Angiography

**CID 30 DICOM Devices**

This Context Group includes codes that may be used to identify a class of equipment that uses DICOM.

**Context ID 30  
DICOM Devices  
Type: Extensible Version: 20030108**

<b>Coding Scheme Designator</b>	<b>Code Value</b>	<b>Code Meaning</b>
INCLUDE CID 29 Acquisition Modality		
DCM	ARCHIVE	Archive
DCM	COMP	Computation Server
DCM	CAD	Computer Assisted Detection/Diagnosis
DCM	DSS	Department System Scheduler
DCM	FILMD	Film Digitizer
DCM	MCD	Media Creation Device
DCM	PRINT	Hard Copy Print Server
DCM	CAPTURE	Image Capture
DCM	LOG	Procedure Logging
DCM	RT	Radiation Therapy Device
DCM	WSD	Workstation

**CID 31 Abstract Priors**

This Context Group includes codes that may be used to identify imaging procedures that may be referred to as priors for the purpose of image set selection in Hanging Protocols.

**Context ID 31  
Abstract Priors  
Type: Extensible Version: 20060126**

<b>Coding Scheme Designator</b>	<b>Code Value</b>	<b>Code Meaning</b>
SRT	G-7292	On admission
SRT	R-400B2	Intraoperative
SRT	R-41FD9	Pre-admission
SRT	R-411C0	Pre-dose
SRT	R-404DA	Post-dose
SRT	R-413C5	Pre-operative
SRT	R-413B7	Post-operative
DCM	109120	On admission to unit
DCM	109121	On discharge
DCM	109122	On discharge from unit
DCM	109123	Pre-intervention
DCM	109124	Post-intervention
DCM	109125	At last appointment

**CID 42 Numeric Value Qualifier**

**CID 42  
Numeric Value Qualifier**

**Type: Extensible      Version: 20020114**

<b>Coding Scheme Designator (0008,0102)</b>	<b>Code Value (0008,0100)</b>	<b>Code Meaning (0008,0104)</b>
DCM	114000	Not a number
DCM	114001	Negative Infinity
DCM	114002	Positive Infinity
DCM	114003	Divide by zero
DCM	114004	Underflow
DCM	114005	Overflow
DCM	114006	Measurement failure
DCM	114007	Measurement not attempted
DCM	114008	Calculation failure
DCM	114009	Value out of range
DCM	114010	Value unknown
DCM	114011	Value indeterminate

**CID 82 Units of Measurement**

**Context ID 82 – Units of Measurement**

Not defined as a table of codes per se, but rather constructed from UCUM. See section 7.2.2.

**CID 83 Units for Real World Value Mapping**

**CID 83  
Units for Real World Value Mapping**

**Type: Extensible Version: 20050822**

<b>Coding Scheme Designator (0008,0102)</b>	<b>Code Value (0008,0100)</b>	<b>Code Meaning (0008,0104)</b>
UCUM	[hnsfU]	Hounsfield unit
UCUM	{counts}	Counts
UCUM	{counts}/s	Counts per second
UCUM	{SUVbw}g/ml	Standardized Uptake Value body weight
UCUM	{SUVlbm}g/ml	Standardized Uptake Value lean body mass
UCUM	{SUVbsa}cm <sup>2</sup> /ml	Standardized Uptake Value body surface area

**CID 220**

**Level of Significance**

**Level of Significance**

**Type: Extensible      Version: 20030327**

<b>Coding Scheme Designator</b>	<b>Code Value</b>	<b>Code Meaning</b>
SRT	R-00333	Most significant
SRT	R-0030C	Highly significant
SRT	R-10045	Significant
SRT	R-00345	Not significant
SRT	R-10046	Significance Undetermined

**CID 221 Measurement Range Concepts**

**Context ID 221**  
**Measurement Range Concepts**  
Type: Extensible Version: 20030327

<b>Coding Scheme Designator</b>	<b>Code Value</b>	<b>Code Meaning</b>
INCLUDE CID 226 Population Statistical Descriptors		
INCLUDE CID 227 Sample Statistical Descriptors		

**CID 222 Normality Codes**

**Context ID 222**  
**Normality Codes**  
Type: Extensible Version: 20030327

<b>Coding Scheme Designator</b>	<b>Code Value</b>	<b>Code Meaning</b>
SRT	G-A460	Normal
SRT	R-42037	Abnormal
SRT	R-002C4	Abnormally High
SRT	R-002C5	Abnormally Low
SRT	G-A385	Normality Undetermined

**CID 223 Normal Range Values**

**Context ID 223**  
**Normal Range Values**  
Type: Extensible Version: 20030327

<b>Coding Scheme Designator</b>	<b>Code Value</b>	<b>Code Meaning</b>
SRT	R-0038B	Normal Range Upper Limit
SRT	R-10041	Normal Range Lower Limit

**CID 224 Selection Method**

**Context ID 224**  
**Selection Method**  
Type: Extensible Version: 20030327

Coding Scheme Designator	Code Value	Code Meaning
DCM	121410	User chosen value
DCM	121411	Most recent value chosen
DCM	121412	Mean value chosen

**CID 225 Measurement Uncertainty Concepts**

**Context ID 225**  
**Measurement Uncertainty Concepts**  
Type: Extensible Version: 20030327

Coding Scheme Designator	Code Value	Code Meaning
SRT	R-00363	+/- , range of measurement uncertainty
SRT	R-00364	+ , range of upper measurement uncertainty
SRT	R-00362	- , range of lower measurement uncertainty

**CID 226 Population Statistical Descriptors**

**Context ID 226**  
**Population Statistical Descriptors**  
Type: Extensible Version: 20030327

Coding Scheme Designator	Code Value	Code Meaning
SRT	R-00337	95th Percentile Value of population
SRT	R-00338	90th Percentile Value of population
SRT	R-00346	1 Sigma Upper Value of population
SRT	R-00387	2 Sigma Upper Value of population
SRT	R-00317	Mean Value of population
SRT	R-00319	Median Value of population
SRT	R-00377	10th Percentile Value of population
SRT	R-00397	5th Percentile Value of population
SRT	R-00347	1 Sigma Lower Value of population
SRT	R-00388	2 Sigma Lower Value of population
DCM	121414	Standard deviation of population
DCM	121417	2 Sigma deviation of population

**CID 227**                      **Sample Statistical Descriptors**

**Context ID 227**  
**Sample Statistical Descriptors**  
Type: **Extensible**                      Version: **20030327**

<b>Coding Scheme Designator</b>	<b>Code Value</b>	<b>Code Meaning</b>
DCM	121415	Percentile Ranking of measurement
DCM	121416	Z-Score of measurement

**CID 228**                      **Equation or Table**

**Context ID 228**  
**Equation or Table**  
Type: **Extensible**                      Version: **20030327**

<b>Coding Scheme Designator</b>	<b>Code Value</b>	<b>Code Meaning</b>
DCM	121420	Equation
DCM	121421	Equation Citation
DCM	121424	Table of Values
DCM	121422	Table of Values Citation
DCM	121423	Method Citation

**CID 230**                      **Yes-No**

**Context ID 230**  
**Yes-No**  
Type: **Non-extensible**                      Version: **20060613**

<b>Coding Scheme Designator</b>	<b>Code Value</b>	<b>Code Meaning</b>
SRT	R-0038D	Yes
SRT	R-00339	No
SRT	R-0038A	Undetermined

**CID 240**                      **Present-Absent**

**Context ID 240**  
**Present-Absent**  
Type: **Non-extensible**                      Version: **20050110**

<b>Coding Scheme Designator</b>	<b>Code Value</b>	<b>Code Meaning</b>
SRT	G-A203	Present
SRT	R-4089B	Absent

SRT	R-40271	Presence Undetermined
-----	---------	-----------------------

**CID 242                      Normal-Abnormal**

This Context Group is a subset of CID 222 Normality Codes.

**Context ID 242  
Normal-Abnormal**

**Type: Extensible      Version: 20030327**

<b>Coding Scheme Designator</b>	<b>Code Value</b>	<b>Code Meaning</b>
SRT	G-A460	Normal
SRT	R-42037	Abnormal
SRT	G-A385	Normality Undetermined

**CID 244                      Laterality**

**Context ID 244  
Laterality**

**Type: Non-Extensible    Version: 20030108**

<b>Coding Scheme Designator (0008,0102)</b>	<b>Code Value (0008,0100)</b>	<b>Code Meaning (0008,0104)</b>
SRT	G-A100	Right
SRT	G-A101	Left
SRT	G-A102	Right and left
SRT	G-A103	Unilateral

**CID 250                      Positive-Negative**

**Context ID 250  
Positive-Negative**

**Type: Extensible      Version: 20040112**

<b>Coding Scheme Designator (0008,0102)</b>	<b>Code Value (0008,0100)</b>	<b>Code Meaning (0008,0104)</b>
SRT	G-A200	Positive
SRT	R-40759	Negative

**CID 251            Severity of Complication**

**Context ID 251**

**Severity of Complication**

**Type: Extensible            Version: 20040112**

<b>Coding Scheme Designator (0008,0102)</b>	<b>Code Value (0008,0100)</b>	<b>Code Meaning (0008,0104)</b>
SRT	R-404F9	Major
SRT	R-404FC	Minor

**CID 270            Observer Type**

**Context ID 270**

**Observer Type**

**Type: Non-Extensible            Version: 20040920**

<b>Coding Scheme Designator</b>	<b>Code Value</b>	<b>Code Meaning</b>
DCM	121006	Person
DCM	121007	Device

**CID 271            Observation Subject Class**

**Context ID 271**

**Observation Subject Class**

**Type: Non-Extensible            Version: 20040920**

<b>Coding Scheme Designator</b>	<b>Code Value</b>	<b>Code Meaning</b>
DCM	121025	Patient
DCM	121026	Fetus
DCM	121027	Specimen

**CID 3000            Audio Channel Source**

**Context ID 3000**

**Audio Channel Source**

**Type: Extensible            Version: 20040326**

<b>Coding Scheme Designator (0008,0102)</b>	<b>Code Value (0008,0100)</b>	<b>Code Meaning (0008,0104)</b>
DCM	109110	Voice
DCM	109111	Operator's narrative
DCM	109112	Ambient room environment
DCM	109113	Doppler audio
DCM	109114	Phonocardiogram



DCM	109115	Physiological audio signal
-----	--------	----------------------------

**CID 3001 ECG Leads**

**Context ID 3001  
ECG Leads**

**Type: Extensible Version: 20020904**

Coding Scheme	Coding Scheme Version	Code Value	Code Meaning
SCPECG	1.3	5.6.3-9-73	Defibrillator lead: anterior-lateral
SCPECG	1.3	5.6.3-9-74	External pacing lead: anterior-posterior
SCPECG	1.3	5.6.3-9-27	Lead A
SCPECG	1.3	5.6.3-9-71	Lead A (Nehb – Anterior)
SCPECG	1.3	5.6.3-9-75	Lead A1 (Auxiliary unipolar lead 1)
SCPECG	1.3	5.6.3-9-76	Lead A2 (Auxiliary unipolar lead 2)
SCPECG	1.3	5.6.3-9-77	Lead A3 (Auxiliary unipolar lead 3)
SCPECG	1.3	5.6.3-9-78	Lead A4 (Auxiliary unipolar lead 4)
SCPECG	1.3	5.6.3-9-57	Lead A-cal
SCPECG	1.3	5.6.3-9-84	Lead A-cal (cal for Nehb – Anterior)
SCPECG	1.3	5.6.3-9-64	Lead aVF
SCPECG	1.3	5.6.3-9-63	Lead aVL
SCPECG	1.3	5.6.3-9-62	Lead aVR
SCPECG	1.3	5.6.3-9-65	Lead -aVR
SCPECG	1.3	5.6.3-9-26	Lead C
SCPECG	1.3	5.6.3-9-19	Lead CC5
SCPECG	1.3	5.6.3-9-49	Lead CC5-cal
SCPECG	1.3	5.6.3-9-56	Lead C-cal
SCPECG	1.3	5.6.3-9-20	Lead CM5
SCPECG	1.3	5.6.3-9-50	Lead CM5-cal
SCPECG	1.3	5.6.3-9-70	Lead D (Nehb – Dorsal)
SCPECG	1.3	5.6.3-9-83	Lead D-cal (cal for Nehb – Dorsal)
SCPECG	1.3	5.6.3-9-25	Lead E
SCPECG	1.3	5.6.3-9-55	Lead E-cal
SCPECG	1.3	5.6.3-9-29	Lead F
SCPECG	1.3	5.6.3-9-59	Lead F-cal
SCPECG	1.3	5.6.3-9-30	Lead H
SCPECG	1.3	5.6.3-9-60	Lead H-cal
SCPECG	1.3	5.6.3-9-1	Lead I (Einthoven)
SCPECG	1.3	5.6.3-9-24	Lead I (Frank)
SCPECG	1.3	5.6.3-9-31	Lead I-cal (Einthoven)
SCPECG	1.3	5.6.3-9-54	Lead I-cal (Frank)

SCPECG	1.3	5.6.3-9-2	Lead II
SCPECG	1.3	5.6.3-9-32	Lead II-cal
SCPECG	1.3	5.6.3-9-61	Lead III
SCPECG	1.3	5.6.3-9-72	Lead J (Nehb – Inferior)
SCPECG	1.3	5.6.3-9-85	Lead J-cal (cal for Nehb – Inferior)
SCPECG	1.3	5.6.3-9-21	Lead Left Arm
SCPECG	1.3	5.6.3-9-51	Lead Left Arm-cal
SCPECG	1.3	5.6.3-9-23	Lead Left Leg
SCPECG	1.3	5.6.3-9-53	Lead Left Leg-cal
SCPECG	1.3	5.6.3-9-28	Lead M
SCPECG	1.3	5.6.3-9-58	Lead M-cal
SCPECG	1.3	5.6.3-9-22	Lead Right Arm
SCPECG	1.3	5.6.3-9-52	Lead Right Arm-cal
SCPECG	1.3	5.6.3-9-3	Lead V1
SCPECG	1.3	5.6.3-9-33	Lead V1-cal
SCPECG	1.3	5.6.3-9-4	Lead V2
SCPECG	1.3	5.6.3-9-34	Lead V2-cal
SCPECG	1.3	5.6.3-9-10	Lead V2R
SCPECG	1.3	5.6.3-9-40	Lead V2R-cal
SCPECG	1.3	5.6.3-9-5	Lead V3
SCPECG	1.3	5.6.3-9-35	Lead V3-cal
SCPECG	1.3	5.6.3-9-11	Lead V3R
SCPECG	1.3	5.6.3-9-41	Lead V3R-cal
SCPECG	1.3	5.6.3-9-6	Lead V4
SCPECG	1.3	5.6.3-9-36	Lead V4-cal
SCPECG	1.3	5.6.3-9-12	Lead V4R
SCPECG	1.3	5.6.3-9-42	Lead V4R-cal
SCPECG	1.3	5.6.3-9-7	Lead V5
SCPECG	1.3	5.6.3-9-37	Lead V5-cal
SCPECG	1.3	5.6.3-9-13	Lead V5R
SCPECG	1.3	5.6.3-9-43	Lead V5R-cal
SCPECG	1.3	5.6.3-9-8	Lead V6
SCPECG	1.3	5.6.3-9-38	Lead V6-cal
SCPECG	1.3	5.6.3-9-14	Lead V6R
SCPECG	1.3	5.6.3-9-44	Lead V6R-cal
SCPECG	1.3	5.6.3-9-9	Lead V7
SCPECG	1.3	5.6.3-9-39	Lead V7-cal
SCPECG	1.3	5.6.3-9-15	Lead V7R
SCPECG	1.3	5.6.3-9-45	Lead V7R-cal
SCPECG	1.3	5.6.3-9-66	Lead V8

SCPECG	1.3	5.6.3-9-79	Lead V8-cal
SCPECG	1.3	5.6.3-9-68	Lead V8R
SCPECG	1.3	5.6.3-9-81	Lead V8R-cal
SCPECG	1.3	5.6.3-9-67	Lead V9
SCPECG	1.3	5.6.3-9-80	Lead V9-cal
SCPECG	1.3	5.6.3-9-69	Lead V9R
SCPECG	1.3	5.6.3-9-82	Lead V9R-cal
SCPECG	1.3	5.6.3-9-16	Lead X
SCPECG	1.3	5.6.3-9-46	Lead X-cal
SCPECG	1.3	5.6.3-9-17	Lead Y
SCPECG	1.3	5.6.3-9-47	Lead Y-cal
SCPECG	1.3	5.6.3-9-18	Lead Z
SCPECG	1.3	5.6.3-9-48	Lead Z-cal
SCPECG	1.3	5.6.3-9-0	Unspecified lead

**CID 3003 Hemodynamic Waveform Sources**

**Context ID 3003**

**Hemodynamic Waveform Sources**

**Type: Extensible Version: 20020904**

Coding Scheme	Code Value	Code Meaning
SRT	G-DB22	Aortic pressure waveform
SRT	G-DB31	Aortic valve pullback pressure waveform
SRT	G-DB24	Arterial pressure waveform
SRT	G-DB23	Central venous pressure waveform
SRT	G-DB33	Dye dilution cardiac output waveform
SRT	G-DB20	Femoral artery pressure waveform
SRT	G-DB12	Hemodynamic flow waveform
SRT	G-DB34	Hemodynamic impedance waveform
SRT	G-DB13	Hemodynamic oxygen saturation waveform
SRT	G-DB11	Hemodynamic pressure waveform
SRT	G-DB10	Hemodynamic waveform
SRT	G-DB19	Left atrium pressure waveform
SRT	G-DB16	Left ventricle pressure waveform
SRT	G-DB28	Mitral valve pullback pressure waveform
SRT	G-DB25	Pulmonary artery oxygen saturation waveform
SRT	G-DB21	Pulmonary artery pressure waveform
SRT	G-DB27	Pulmonary artery wedge pressure waveform
SRT	G-DB26	Pulmonary capillary wedge pressure waveform
SRT	G-DB30	Pulmonary valve pullback pressure waveform
SRT	G-DB14	Respiration impedance waveform

SRT	G-DB18	Right atrium pressure waveform
SRT	G-DB17	Right ventricle pressure waveform
SRT	G-DB15	Temperature waveform
SRT	G-DB32	Thermal cardiac output waveform
SRT	G-DB29	Tricuspid valve pullback pressure waveform

**CID 3010 Cardiovascular Anatomic Locations**

**Context ID 3010  
Cardiovascular Anatomic Locations  
Type: Extensible Version: 20061024**

Coding Scheme	Code Value	Code Meaning
SNM3	T-42500	Abdominal aorta
SRT	T-48503	Anomalous pulmonary vein
SRT	T-49215	Antecubital vein
SNM3	T-48440	Anterior cardiac vein
SNM3	T-45530	Anterior communicating artery
SNM3	T-45730	Anterior spinal artery
SNM3	T-47700	Anterior tibial artery
SNM3	T-42000	Aorta
SNM3	T-42300	Aortic arch
SRT	D3-81922	Aortic fistula
SRT	T-32602	Apex of left ventricle
SRT	T-32502	Apex of right ventricle
SNM3	T-41000	Artery
SNM3	T-42100	Ascending aorta
SNM3	T-47100	Axillary Artery
SNM3	T-49110	Axillary vein
SNM3	T-48340	Azygos vein
SRT	A-00203	Baffle
SNM3	T-45800	Basilar artery
SNM3	T-D00AB	Body conduit
SRT	T-49424	Boyd's perforating vein
SNM3	T-47160	Brachial artery
SNM3	T-49350	Brachial vein
SNM3	T-45010	Carotid Artery
SNM3	T-49240	Cephalic vein
SNM3	T-45510	Cerebral artery
SNM3	D4-31320	Common atrium
SNM3	T-45100	Common carotid artery
SNM3	T-46710	Common iliac artery

SNM3	T-48920	Common iliac vein
SNM3	D4-31120	Common ventricle
SRT	D4-32504	Congenital coronary artery fistula to left atrium
SRT	D4-32506	Congenital coronary artery fistula to left ventricle
SRT	D4-32509	Congenital coronary artery fistula to right atrium
SRT	D4-32510	Congenital coronary artery fistula to right ventricle
SNM3	D3-40208	Congenital pulmonary arteriovenous fistula
SNM3	T-43000	Coronary artery
SNM3	T-48410	Coronary sinus
SNM3	T-42400	Descending aorta
SRT	T-49429	Dodd's perforating vein
SNM3	T-45200	External carotid artery
SNM3	T-46910	External iliac artery
SNM3	T-48930	External iliac vein
SNM3	T-45240	Facial artery
SNM3	T-47400	Femoral artery
SNM3	T-49410	Femoral vein
SNM3	T-48820	Gastric vein
SRT	T-47490	Genicular artery
SNM3	T-48420	Great cardiac vein
SNM3	T-46420	Hepatic artery
SNM3	T-48720	Hepatic vein
SRT	T-4942A	Hunterian perforating vein
SNM3	T-46700	Iliac artery
SNM3	T-48470	Inferior cardiac vein
SNM3	T-48540	Inferior left pulmonary vein
SNM3	T-46520	Inferior mesenteric artery
SNM3	T-48520	Inferior right pulmonary vein
SNM3	T-48710	Inferior vena cava
SNM3	T-46010	Innominate artery
SNM3	T-48620	Innominate vein
SNM3	T-45300	Internal carotid artery
SNM3	T-48170	Internal jugular vein
SNM3	T-46740	Internal iliac artery
SNM3	T-46200	Internal mammary artery
SRT	D4-31052	Juxtaposed atrial appendage
SNM3	T-45410	Lacrimal artery
SRT	T-45416	Lacrimal artery of right eye
SNM3	T-32300	Left atrium
SNM3	T-32310	Left auricular appendage

SNM3	T-47420	Left femoral artery
SNM3	T-44400	Left pulmonary artery
SNM3	T-32600	Left ventricle
SNM3	T-32640	Left ventricle inflow
SRT	D4-31022	Left ventricle outflow chamber
SNM3	T-32650	Left ventricle outflow tract
SNM3	T-45230	Lingual artery
SNM3	T-46960	Lumbar artery
SNM3	T-46500	Mesenteric artery
SRT	T-4884A	Mesenteric vein
SNM3	T-45250	Occipital artery
SNM3	T-48214	Occipital vein
SNM3	T-45400	Ophthalmic artery
SNM3	D4-32012	Patent ductus arteriosus
SNM3	T-47630	Peroneal artery
SNM3	T-47500	Popliteal artery
SNM3	T-48810	Portal vein
SNM3	T-45320	Posterior communication artery
SRT	T-49535	Posterior medial tributary
SNM3	T-47600	Posterior tibial artery
SNM3	T-F7001	Primitive aorta
SNM3	T-F7040	Primitive pulmonary artery
SNM3	T-44000	Pulmonary artery
SRT	D4-33142	Pulmonary artery conduit
SRT	T-32190	Pulmonary chamber of cor triatriatum
SNM3	T-48500	Pulmonary vein
SRT	D4-33512	Pulmonary vein confluence
SRT	D4-33514	Pulmonary venous atrium
SNM3	T-47300	Radial artery
SNM3	T-46600	Renal artery
SNM3	T-48740	Renal vein
SNM3	T-32200	Right atrium
SNM3	T-32210	Right auricular appendage
SNM3	T-47410	Right femoral artery
SNM3	T-44200	Right pulmonary artery
SNM3	T-32500	Right ventricle
SNM3	T-32540	Right ventricle inflow
SRT	D4-31032	Right ventricle outflow chamber
SNM3	T-32550	Right ventricle outflow tract
SRT	T-D930A	Saphenofemoral junction

SNM3	T-49530	Saphenous vein
SNM3	T-46460	Splenic artery
SNM3	T-48890	Splenic vein
SNM3	T-46100	Subclavian artery
SNM3	T-48330	Subclavian vein
SNM3	T-45270	Superficial temporal artery
SNM3	T-48530	Superior left pulmonary vein
SNM3	T-46510	Superior mesenteric artery
SNM3	T-48510	Superior right pulmonary vein
SNM3	T-45210	Superior thyroid artery
SNM3	T-48610	Superior vena cava
SRT	T-44007	Systemic collateral artery to lung
SRT	D4-33516	Systemic venous atrium
SNM3	T-42070	Thoracic aorta
SNM3	D4-31400	Truncus arteriosus communis
SNM3	T-46400	Truncus coeliacus
SNM3	T-47200	Ulnar artery
SNM3	T-F1810	Umbilical artery
SNM3	T-48817	Umbilical vein
SNM3	T-48000	Vein
SNM3	T-48003	Venous network
SNM3	T-45700	Vertebral artery

**CID 3011          Electrophysiology Anatomic Locations**

**Context ID 3011  
Electrophysiology Anatomic Locations  
Type: Extensible Version: 20020904**

Coding Scheme	Code Value	Code Meaning
SNM3	T-32850	Accessory atrioventricular bundle
SRT	T-32602	Apex of left ventricle
SRT	T-32502	Apex of right ventricle
SNM3	T-32830	Atrioventricular bundle
SNM3	T-32820	Atrioventricular node
SNM3	T-32400	Common ventricle
SNM3	T-48410	Coronary sinus
SNM3	T-39010	Epicardium
SNM3	T-48420	Great cardiac vein
SRT	G-DE02	High right atrium
SNM3	T-48540	Inferior left pulmonary vein
SNM3	T-48520	Inferior right pulmonary vein

SRT	G-DE04	Lateral high right atrium
SNM3	T-32833	Left anterior division of left branch of left atrioventricular bundle
SNM3	T-32300	Left Atrium
SNM3	T-32310	Left auricular appendage
SNM3	T-32832	Left branch of atrioventricular bundle
SNM3	T-32834	Left posterior division of left branch of left atrioventricular bundle
SNM3	T-32600	Left ventricle
SNM3	T-32640	Left ventricle inflow
SNM3	T-32650	Left ventricle outflow tract
SRT	G-DE08	Low right atrium
SRT	G-DE06	Mid right atrium
SNM3	T-48430	Middle cardiac vein
SNM3	T-35310	Mitral ring
SNM3	T-48411	Ostium of coronary sinus
SNM3	T-48500	Pulmonary vein
SNM3	T-35210	Pulmonic ring
SNM3	T-32840	Purkinje fibers
SNM3	T-35120	Right atrioventricular ostium
SNM3	T-32200	Right Atrium
SNM3	T-32210	Right auricular appendage
SNM3	T-32831	Right branch of Atrioventricular bundle
SNM3	T-32500	Right ventricle
SNM3	T-32540	Right ventricle inflow
SNM3	T-32550	Right ventricle outflow tract
SNM3	T-32810	Sino-atrial node
SNM3	T-48530	Superior left pulmonary vein
SNM3	T-48510	Superior right pulmonary vein
SRT	T-32202	Tendon of Todaro
SNM3	T-35110	Tricuspid ring

**CID 3014      Coronary Artery Segments**

**Context ID 3014  
Coronary Artery Segments**

**Type: Extensible Version: 20020904**

Coding Scheme	Coding Scheme Version	Code Value	Code Meaning	SNOMED (SRT) Equivalent
BARI	1992	15	1st Diagonal Coronary Artery	T-43117
BARI	1992	24	1st Left Posterolateral Coronary Artery	T-4312B
BARI	1992	20	1st Marginal Coronary Artery	T-43128



BARI	1992	6	1st Right posterolateral Coronary Artery	T-43213
BARI	1992	17	1st Septal Coronary Artery	T-43002
BARI	1992	16	2nd Diagonal Coronary Artery	T-43118
BARI	1992	25	2nd Left Posterolateral Coronary Artery	T-4312C
BARI	1992	21	2nd Marginal Coronary Artery	T-43129
BARI	1992	7	2nd Right posterolateral Coronary Artery	T-43214
BARI	1992	29	3rd diagonal Coronary Artery	T-43119
BARI	1992	26	3rd Left Posterolateral Coronary Artery	T-4312D
BARI	1992	22	3rd Marginal Coronary Artery	T-4312A
BARI	1992	8	3rd Right posterolateral Coronary Artery	T-43215
BARI	1992	10	Acute Marginal Coronary Artery	
BARI	1992	23	AV groove continuation of Circumflex Artery	T-43124
BARI	1992	19A	Distal Circumflex Coronary Artery	T-43122
BARI	1992	14	Distal Left Anterior Descending Coronary Artery	T-43112
BARI	1992	3	Distal Right Coronary Artery	T-43202
BARI	1992	15A	Lateral 1st Diagonal Coronary Artery	
BARI	1992	20A	Lateral 1st Marginal Coronary Artery	
BARI	1992	16A	Lateral 2nd Diagonal Coronary Artery	
BARI	1992	21A	Lateral 2nd Marginal Coronary Artery	
BARI	1992	29A	Lateral 3rd Diagonal Coronary Artery	
BARI	1992	22A	Lateral 3rd Marginal Coronary Artery	
BARI	1992	28A	Lateral Ramus	
BARI	1992	11	Left Main Coronary Artery	T-43107
BARI	1992	11A	Left Main Coronary Artery Ostium	T-43105
BARI	1992	27	Left Posterior Descending Artery	T-43126
BARI	1992	19	Mid Circumflex Coronary Artery	T-43127
BARI	1992	13	Mid Left Anterior Descending Coronary Artery	T-43115
BARI	1992	2	Mid Right Coronary Artery	
BARI	1992	4	Posterior Descending Right Coronary Artery	T-43210
BARI	1992	9	Posterior descending septal perforators	
BARI	1992	18	Proximal Circumflex Coronary Artery	T-43121
BARI	1992	12	Proximal Left Anterior Descending Coronary Artery	T-43111
BARI	1992	1	Proximal Right Coronary Artery	T-43201
BARI	1992	28	Ramus	
BARI	1992	1A	Right Coronary Artery Ostium	T-43205
BARI	1992	5	Right posterior AV Coronary Artery	

**CID 3015          Coronary Arteries**

**Context ID 3015  
Coronary Arteries  
Type: Non-Extensible   Version: 20030327**

<b>Coding Scheme Designator</b>	<b>Code Value</b>	<b>Code Meaning</b>
Include CONTEXT ID 3014 Coronary Artery Segments		
SNM3	T-4311A	Left Anterior Descending Coronary Artery
SNM3	T-43203	Right Coronary Artery
SNM3	T-43120	Circumflex Coronary Artery

**CID 3019          Cardiovascular Anatomic Location Modifiers**

**Context ID 3019  
Cardiovascular Anatomic Location Modifiers  
Type: Extensible       Version: 20030327**

<b>Coding Scheme</b>	<b>Code Value</b>	<b>Code Meaning</b>
SNM3	G-A105	Anterior
SRT	G-D873	Arterial graft to cited segment
SNM3	GA110	Central
SNM3	G-A119	Distal
SRT	G-D870	Graft to cited segment, body
SRT	G-D872	Graft to cited segment, distal anastomosis
SRT	G-D871	Graft to cited segment, proximal anastomosis
SNM3	G-A115	Inferior
SRT	G-A104	Lateral
SNM3	G-A101	Left
SRT	T-3215A	Ostium
SNM3	G-A106	Posterior
SNM3	G-A118	Proximal
SNM3	G-A100	Right
SNM3	G-A116	Superior
SRT	G-D874	Venous graft to cited segment
SRT	T-40003	Entire Vessel
DCM	122101	Aneurysm on cited vessel
DCM	122102	Graft to cited segment, proximal section
DCM	122103	Graft to cited segment, mid section
DCM	122104	Graft to cited segment, distal section

**CID 3082      Cardiology Units of Measurement**

**Context ID 3082  
Cardiology Units of Measurement  
Type: Extensible Version: 20060613**

Coding Scheme	Coding Scheme Version	Code Value	Code Meaning
UCUM	1.4	dB(A)	A scale of loudness
UCUM	1.4	[arb'U]	arbitrary unit
UCUM	1.4	cm	centimeter
UCUM	1.4	cm/s	centimeter/second
UCUM	1.4	d	day
UCUM	1.4	dB	decibel
UCUM	1.4	Cel	degrees Celsius
UCUM	1.4	{H.B.}/min	Heart beat per minute
UCUM	1.4	Hz	Herz
UCUM	1.4	h	hour
UCUM	1.4	J	Joule
UCUM	1.4	kHz	kiloHerz
UCUM	1.4	kOhm	kiloOhm
UCUM	1.4	km/h	kilometer per hour
UCUM	1.4	kPa	kiloPascal
UCUM	1.4	l/min	liter per minute
UCUM	1.4	MHz	megaHerz
UCUM	1.5	[MET]	Metabolic equivalent
UCUM	1.4	uV	microvolt
UCUM	1.4	[mi_i]/h	mile per hour
UCUM	1.4	mm	millimeter
UCUM	1.4	ml/min	milliliter per minute
UCUM	1.4	ml/s	milliliter per second
UCUM	1.4	mm[Hg]	millimeter of mercury
UCUM	1.4	mV	millivolt
UCUM	1.4	min	minute
UCUM	1.4	mm/s	mm/s
UCUM	1.4	%	percent
UCUM	1.4	s	second
UCUM	1.4	mm2	square millimeter
UCUM	1.4	1	unary
UCUM	1.4	V	volt
UCUM	1.4	W	Watt

**CID 3090 Time Synchronization Channel Types**

**Context ID 3090**  
**Time Synchronization Channel Types**  
**Type: Extensible Version: 20020904**

Coding Scheme	Code Value	Code Meaning
DCM	109001	Digital timecode (NOS)
DCM	109002	ECG-based gating signal, processed
DCM	109003	IRIG-B timecode
DCM	109004	X-ray Fluoroscopy On Signal
DCM	109005	X-ray On Trigger

**CID 3101 NM Procedural State Values**

**Context ID 3101**  
**NM Procedural State Values**  
**Type: Extensible Version: 20040112**

Coding Scheme Designator (0008,0102)	Code Value (0008,0100)	Code Meaning (0008,0104)
SRT	F-01604	Resting State
DCM	109091	Cardiac Stress State
DCM	109092	Reinjection State
DCM	109093	Redistribution State
DCM	109094	Delayed Redistribution State

**CID 3240 Electrophysiology Measurement Functions and Techniques**

**Context ID 3240**  
**Electrophysiology Measurement Functions and Techniques**  
**Type: Extensible Version: 20020904**

Coding Scheme	Code Value	Code Meaning
DCM	109006	Differential signal
DCM	109007	His bundle electrogram
DCM	109008	Monopole signal
DCM	109009	Pacing (electrical) stimulus, voltage
DCM	109010	Radio frequency ablation, power
DCM	109011	Voltage measurement by basket catheter
DCM	109012	Voltage measurement by mapping catheter
DCM	109013	Voltage measurement, NOS

**CID 3241 Hemodynamic Measurement Techniques**

**Context ID 3241  
Hemodynamic Measurement Techniques**

**Type: Extensible Version: 20020904**

Coding Scheme	Code Value	Code Meaning
SRT	PA-50038	Averaged hemodynamic measurement method
SRT	PA-50035	Composite hemodynamic measurement method
SRT	PA-50034	Computed hemodynamic measurement method
SRT	PA-5003B	Conductance catheter method
SRT	PA-5003C	Doppler catheter method
SRT	PA-50031	Dual catheter method
SRT	PA-50039	Fluid filled catheter method
SRT	PA-5003D	Fiberoptic catheter method
SRT	PA-5003E	Hall catheter method
SRT	PA-50033	Pullback method
SRT	PA-50032	Pulmonary capillary wedge method
SRT	PA-50036	Static catheter method
SRT	PA-5003F	Thermistor catheter method
SRT	PA-5003A	Tip manometer method
SRT	PA-50037	Wedge method

**CID 3250 Catheterization Procedure Phase**

**Context ID 3250  
Catheterization Procedure Phase**

**Type: Extensible Version: 20030327**

Coding Scheme	Code Value	Code Meaning
SRT	G-7299	Cardiac catheterization bailout phase
SRT	G-7293	Cardiac catheterization baseline phase
SRT	G-7294	Cardiac catheterization image acquisition phase
SRT	G-7295	Cardiac catheterization intervention phase
SRT	G-729B	Cardiac catheterization post contrast phase
SRT	G-7298	Cardiac catheterization post-intervention phase
SRT	G-7296	Cardiac catheterization pre-intervention phase
SRT	G-929D	Cardiac catheterization test/challenging phase
SRT	G-7297	Cardiac catheterization therapy phase
SRT	P1-3160A	Catheterization of both left and right heart with graft
SRT	P1-3160B	Catheterization of both left and right heart without graft
SNM3	P1-31604	Catheterization of left heart
SNM3	P1-31602	Catheterization of right heart

SNM3	P1-31612	Transseptal catheterization
SRT	P2-71317	Drug Infusion Challenge
SRT	P2-71310	Exercise challenge
SRT	F-01604	Resting State

**CID 3254 Electrophysiology Procedure Phase**

**Context ID 3254**  
**Electrophysiology Procedure Phase**  
**Type: Extensible Version: 20020904**

Coding Scheme	Code Value	Code Meaning
SRT	G-729D	Atrial Effective Refractory Period, evaluation of
SRT	G-7304	Carotid Sinus Massage procedure phase
SRT	G-7306	Electrophysiology Mapping phase
SRT	G-729A	Electrophysiology procedure baseline phase
SRT	G-7408	Post-ablation phase
SRT	G-7305	Post-defibrillation procedure phase
SRT	G-729F	Radiofrequency Ablation procedure phase
SRT	G-729C	Sinus Node Recovery Time, evaluation of
SRT	G-729E	Ventricular Effective Refractory Period, evaluation of

**CID 3261 Stress Protocols**

**Context ID 3261**  
**Stress Protocols**  
**Type: Extensible Version: 20020904**

Coding Scheme	Code Value	Code Meaning
SRT	P2-7131C	Balke protocol
SRT	P2-7131A	Bruce protocol
SRT	P2-7131D	Ellestad protocol
SRT	P2-7131B	Modified Bruce protocol
SRT	P2-713A1	Modified Naughton protocol
SRT	P2-713A0	Naughton protocol
SRT	P2-7131F	Pepper protocol
SRT	P2-7131E	Ramp protocol

**CID 3262 ECG Patient State Values**

**Context ID 3262**  
**ECG Patient State Values**  
**Type: Extensible Version: 20020904**

Coding	Code Value	Code Meaning
--------	------------	--------------

Scheme		
SRT	F-01602	Baseline state
SRT	F-01606	Exercise state
SRT	F-01608	Post-exercise state
SRT	F-01604	Resting state
SNM3	F-10340	Supine body position

**CID 3263 Electrode Placement Values**

**Context ID 3263  
Electrode Placement Values**

**Type: Extensible Version: 20020904**

Coding Scheme	Coding Scheme Version	Code Value	Code Meaning
SCPECG	1.3	5.4.5-33-1-5	12-lead ECG derived from Frank XYZ leads
SCPECG	1.3	5.4.5-33-1-6	12-lead ECG derived from non-standard leads
SCPECG	1.3	5.4.5-33-1-2	Mason-Likar positions: limb leads placed on the torso
SCPECG	1.3	5.4.5-33-1-3	Mason-Likar with V pad: chest leads as a single pad
SCPECG	1.3	5.4.5-33-1-4	Single electrode pad: all electrodes in a single electrode pad
SCPECG	1.3	5.4.5-33-1-1	Standard 12-lead positions: limb leads placed at extremities
SCPECG	1.3	5.4.5-33-1-0	Unspecified

**CID 3264 XYZ Electrode Placement Values**

**Context ID 3264  
XYZ Electrode Placement Values**

**Type: Extensible Version: 20020904**

Coding Scheme	Coding Scheme Version	Code Value	Code Meaning
SCPECG	1.3	5.4.5-33-2-4	Bipolar uncorrected XYZ lead system
SCPECG	1.3	5.4.5-33-2-3	Cube lead system (Grishman et al, Amer Heart J 1951; 41:483).
SCPECG	1.3	5.4.5-33-2-1	Frank lead system (Frank, 1956; 13:737)
SCPECG	1.3	5.4.5-33-2-2	McFee-Parungao lead system
SCPECG	1.3	5.4.5-33-2-5	Pseudo-orthogonal XYZ lead system (as used in Holter recording)
SCPECG	1.3	5.4.5-33-2-0	Unspecified
SCPECG	1.3	5.4.5-33-2-6	XYZ leads derived from standard 12-lead ECG

**CID 3271 Hemodynamic Physiological Challenges**

**Context ID 3271  
Hemodynamic Physiological Challenges**

**Type: Extensible Version: 20020904**

Coding Scheme	Code Value	Code Meaning
SRT	P2-71317	Drug infusion
SRT	P2-71310	Exercise challenge
SRT	P2-71306	Handgrip
SRT	P2-71302	Head up
SRT	P2-71314	Held inspiration
SRT	P2-71316	Held ventilation
SRT	P2-71304	Leg up
SRT	P2-71308	Negative lower body pressure
SNM3	P2-35000	Pacing
SRT	P2-71318	Post volume challenge
SRT	P2-71312	Vagal stimulation
SNM3	F-F7102	Valsalva maneuver

**CID 3335 ECG Annotations**

**Context ID 3335  
ECG Annotations**

**Type: Extensible Version: 20020904**

Coding Scheme	Coding Scheme Version	Code Value	Code Meaning
SCPECG	1.3	5.7.1-3	Fiducial point
SCPECG	1.3	D.4.1-J	J point
SCPECG	1.3	D.4.1-ST20	J point + 20 msec
SCPECG	1.3	D.4.1-ST60	J point + 60 msec
SCPECG	1.3	D.4.1-ST80	J point +80 msec
SCPECG	1.3	5.10.3-2	P wave end
SCPECG	1.3	5.10.3-1	P wave onset
SCPECG	1.3	D.4.1-P	P wave peak
SCPECG	1.3	5.10.1.2	Pacemaker spike, suppressed
SCPECG	1.3	D.4.1-PR	PR segment (isoelectric point)
SCPECG	1.3	D.4.1-Q	Q wave
SCPECG	1.3	5.10.3-4	QRS end
SCPECG	1.3	5.10.3-3	QRS onset
SCPECG	1.3	D.4.1-R	R wave peak
SCPECG	1.3	D.4.1-R2	R' peak
SCPECG	1.3	D.4.1-S	S wave



SCPECG	1.3	D.4.1-S2	S' wave
SCPECG	1.3	5.10.3-5	T wave end
SCPECG	1.3	D.4.1-STE	T wave onset
SCPECG	1.3	D.4.1-T	T wave peak
SCPECG	1.3	D.4.1-U	U wave peak

**CID 3337 Hemodynamic Annotations**

**Context ID 3337**  
**Hemodynamic Annotations**  
**Type: Extensible Version: 20050322**

Coding Scheme	Code Value	Code Meaning
DCM	109014	35% of thermal/dye dilution CO
DCM	109015	70% of thermal/dye dilution CO
DCM	109016	A wave peak pressure
DCM	109017	A wave pressure, average
DCM	109018	Beat detected (accepted)
DCM	109019	Beat detected (rejected)
SRT	F-00E22	Average diastolic blood pressure
SRT	F-00E1F	Minimum diastolic blood pressure
SRT	F-32011	End diastole
DCM	109023	End of expiration
DCM	109024	End of inspiration
DCM	109070	End of systole
DCM	109071	Indicator mean transit time
DCM	109025	Max dp/dt
DCM	109026	Max neg dp/dt
SRT	F-31150	Mean blood pressure
DCM	109028	Peak of thermal cardiac output bolus
DCM	109029	Start of expiration
DCM	109030	Start of inspiration
DCM	109031	Start of thermal CO
SRT	F-00E14	Average systolic blood pressure
SRT	F-00E11	Maximum systolic blood pressure
DCM	109072	Tau
DCM	109073	V max myocardial
DCM	109034	V wave peak pressure
DCM	109035	V wave pressure, average
DCM	109036	Valve close
DCM	109037	Valve open

**CID 3339      Electrophysiology Annotations**

**Context ID 3339  
Electrophysiology Annotations  
Type: Extensible Version: 20020904**

Coding Scheme	Code Value	Code Meaning
DCM	109038	Ablation off
DCM	109039	Ablation on
DCM	109040	HIS bundle wave
DCM	109041	P wave
DCM	109042	Q wave
DCM	109043	R wave
DCM	109044	S wave
DCM	109045	Start of atrial contraction
DCM	109046	Start of atrial contraction (subsequent)
DCM	109047	Stimulation at rate 1 interval
DCM	109048	Stimulation at rate 2 interval
DCM	109049	Stimulation at rate 3 interval
DCM	109050	Stimulation at rate 4 interval
DCM	109051	T wave
DCM	109052	V wave
DCM	109053	V wave of next beat

**CID 3400      Procedure Log Titles**

**Context ID 3400  
Procedure Log Titles  
Type: Extensible      Version: 20030327**

Coding Scheme Designator	Code Value	Code Meaning
DCM	121120	Cath Lab Procedure Log

**CID 3401      Types of Log Notes**

**Context ID 3401  
Types of Log Notes  
Type: Extensible      Version: 20030327**

Coding Scheme Designator	Code Value	Code Meaning
DCM	121171	Tech Note

DCM	121172	Nursing Note
DCM	121173	Physician Note
DCM	121174	Procedure Note
DCM	121123	Patient Status or Event

**CID 3402 Patient Status and Events**

**Context ID 3402**  
**Patient Status and Events**  
**Type: Extensible Version: 20030327**

<b>Coding Scheme Designator</b>	<b>Code Value</b>	<b>Code Meaning</b>
DCM	122001	Patient called to procedure room
DCM	122002	Patient admitted to procedure room
DCM	122003	Patient given pre-procedure instruction
DCM	122004	Patient informed consent given
DCM	122005	Patient advance directive given
DCM	122006	Nil Per Os (NPO) status confirmed
DCM	122007	Patient assisted to table
DCM	122008	Patient prepped and draped
DCM	122009	Patient connected to continuous monitoring
DCM	122010	Patient transferred to holding area
DCM	122011	Patient transferred to surgery
DCM	122012	Patient transferred to CCU
DCM	122020	Patient disoriented
DCM	122021	Patient reports nausea
DCM	122022	Patient reports discomfort
DCM	122023	Patient reports chest pain
DCM	122024	Patient reports no pain
DCM	122025	Patient alert
DCM	122026	Patient restless
DCM	122027	Patient sedated
DCM	122028	Patient asleep
DCM	122029	Patient unresponsive
DCM	122030	Patient has respiratory difficulty
DCM	122031	Patient coughed
DCM	122032	Patient disconnected from continuous monitoring
DCM	122033	Hemostasis achieved
DCM	122034	Hemostasis not achieved – oozing
DCM	122035	Hemostasis not achieved – actively bleeding
DCM	122036	Patient given post-procedure instruction

DCM	122038	Patient pronounced dead
DCM	122039	Patient transferred to morgue
DCM	122037	Patient discharged

**CID 3403 Percutaneous Entry**

**Context ID 3403  
Percutaneous Entry  
Type: Extensible                      Version: 20030327**

<b>Coding Scheme Designator</b>	<b>Code Value</b>	<b>Code Meaning</b>
INCLUDE CID 3746 Percutaneous Entry		
INCLUDE CID 3747 Percutaneous Closure		

**CID 3404 Staff Actions**

**Context ID 3404  
Staff Actions  
Type: Extensible                      Version: 20030327**

<b>Coding Scheme Designator</b>	<b>Code Value</b>	<b>Code Meaning</b>
DCM	122041	Personnel Arrived
DCM	122042	Personnel Departed
DCM	122043	Page Sent To
DCM	122044	Consultation With
DCM	122045	Office called

**CID 3405 Procedure Action Values**

**Context ID 3405  
Procedure Action Values  
Type: Extensible                      Version: 20030327**

<b>Coding Scheme Designator</b>	<b>Code Value</b>	<b>Code Meaning</b>
SRT	P1-30350	Atherectomy
SRT	P1-30351	Atherectomy by rotary cutter
SRT	P1-30352	Atherectomy by laser
SRT	P1-30530	Selective embolization of artery
SRT	P5-31500	Percutaneous transluminal balloon angioplasty
SRT	P5-39010	Transcatheter therapy for embolization

SRT	P5-39050	Percutaneous retrieval of intravascular foreign body
SRT	P1-05550	Stent placement
SRT	P5-39015	Transcatheter deployment of detachable balloon
SRT	P5-39191	Percutaneous insertion of intravascular filter
INCLUDE CID 3250 Catheterization Procedure Phases		
INCLUDE CID 3406 Non-Coronary Transcatheter Interventions		
INCLUDE CID 3428 Imaging Procedures		

**CID 3406 Non-Coronary Transcatheter Interventions**

**Context ID 3406**  
**Non-Coronary Transcatheter Interventions**  
**Type: Extensible                      Version: 20030327**

<b>Coding Scheme Designator</b>	<b>Code Value</b>	<b>Code Meaning</b>
DCM	122053	Valvular Intervention
DCM	122054	Aortic Intervention
DCM	122055	Septal Defect Intervention
DCM	122056	Vascular Intervention
DCM	122057	Myocardial biopsy

**CID 3407 Purpose of Reference to Object**

**Context ID 3407**  
**Purpose of Reference to Object**  
**Type: Extensible                      Version: 20030327**

<b>Coding Scheme Designator</b>	<b>Code Value</b>	<b>Code Meaning</b>
DCM	122072	Pre-procedure log
DCM	122073	Analysis or measurements for current procedure
DCM	122075	Prior report for current patient

**CID 3408 Actions with Consumables**

**Context ID 3408**  
**Actions with Consumables**  
**Type: Extensible                      Version: 20030327**

<b>Coding Scheme</b>	<b>Code Value</b>	<b>Code Meaning</b>

<b>Designator</b>		
DCM	122076	Consumable taken from inventory
DCM	122077	Consumable returned to inventory
DCM	122078	Remaining consumable disposed
DCM	122079	Consumable unusable

**CID 3409 Administration of Drugs/Contrast**

**Context ID 3409  
Administration of Drugs/Contrast**

**Type: Extensible Version: 20030327**

<b>Coding Scheme Designator</b>	<b>Code Value</b>	<b>Code Meaning</b>
DCM	122081	Drug start
DCM	122082	Drug end
DCM	122083	Drug administered
DCM	122084	Contrast start
DCM	122085	Contrast end
DCM	122086	Contrast administered
DCM	122087	Infusate start
DCM	122088	Infusate end

**CID 3410 Numeric Parameters of Drugs/Contrast**

**Context ID 3410  
Numeric Parameters of Drugs/Contrast  
Type: Extensible Version: 20030327**

<b>Coding Scheme Designator</b>	<b>Code Value</b>	<b>Code Meaning</b>
DCM	122091	Volume administered
DCM	122092	Undiluted dose administered
DCM	122093	Concentration
DCM	122094	Rate of administration
DCM	122095	Duration of administration
DCM	122096	Volume unadministered or discarded

**CID 3411 Intracoronary Devices**

**Context ID 3411**  
**Intracoronary Devices**  
**Type: Extensible Version: 20030327**

<b>Coding Scheme Designator</b>	<b>Code Value</b>	<b>Code Meaning</b>	<b>NCDR Equivalent</b>	<b>Trade Name (Informative)</b>
SRT	A-26912	Percutaneous Transluminal Angioplasty Balloon	113-1	
SRT	R-002F0	Cutting Balloon Angioplasty (CBA) Device	113-2	
SRT	A-25500	Stent	113-3	
SRT	R-002FD	Directional Coronary Atherectomy (DCA) Device	113-4	
SRT	A-25610	Rotational Atherectomy Device	113-5	Rotablator™
SRT	R-0036F	Saline Thrombectomy	113-6	AngioJet™
SRT	A-26920	Transluminal Extraction Catheter (TEC)	113-7	
SRT	A-81080	Laser	113-8	
SRT	R-00312	Intravascular Ultrasound (IVUS) Device	113-9	
SRT	R-00310	Intracoronary Doppler guide wire	113-10	Flowire™
SRT	R-00311	Intracoronary pressure guide wire	113-11	
SRT	A-040ED	Brachytherapy Device		
SRT	R-00361	Radiofrequency Ablation Device		

**CID 3412 Intervention Actions and Status**

**Context ID 3412**  
**Intervention Actions and Status**  
**Type: Extensible Version: 20030327**

<b>Coding Scheme Designator</b>	<b>Code Value</b>	<b>Code Meaning</b>
DCM	122301	Guidewire crossing lesion unsuccessful
DCM	122302	Guidewire crossing lesion successful
DCM	122303	Angioplasty balloon inflated
DCM	122304	Angioplasty balloon deflated
DCM	122305	Device deployed
DCM	122306	Stent re-expanded
DCM	122307	Object removed
DCM	122308	Radiation applied
DCM	122309	Radiation removed
DCM	122310	Interventional device placement unsuccessful
DCM	122311	Interventional device placed

DCM	122312	Intervention performed
DCM	122313	Interventional device withdrawn

**CID 3413 Adverse Outcomes**

**Context ID 3413**  
**Adverse Outcomes**  
Type: Extensible Version: 20030327

Coding Scheme Designator	Code Value	Code Meaning
DCM	122167	Death During Catheterization
INCLUDE CID 3754 Vascular Complications		
INCLUDE CID 3755 Cath Complications		

**CID 3414 Procedure Urgency**

**Context ID 3414**  
**Procedure Urgency**  
Type: Extensible Version: 20030327

Coding Scheme Designator	Code Value	Code Meaning	NCDR Equivalents
SRT	G-D210	Elective Procedure	21-1, 78-1, 92-1
SRT	G-D216	Urgent Procedure	21-2, 78-2, 92-2
SRT	G-D209	Emergent Procedure	21-3, 78-3, 92-3
SRT	R-41C8D	Salvage Procedure	21-4, 78-4, 92-4

**CID 3415 Cardiac Rhythms**

**Context ID 3415**  
**Cardiac Rhythms**  
Type: Extensible Version: 20030327

Coding Scheme Designator	Code Value	Code Meaning
SCPECG	D.3.2.6-SR	sinus rhythm
SCPECG	D.3.2.6-NSR	normal sinus rhythm
SCPECG	D.3.2.6-SARRH	sinus arrhythmia
SCPECG	D.3.2.6-MSAR	marked sinus arrhythmia
SCPECG	D.3.2.6-SVARR	supraventricular arrhythmia
SCPECG	D.3.2.6-STACH	sinus tachycardia
SCPECG	D.3.2.6-ETACH	extreme tachycardia
SCPECG	D.3.2.6-SBRAD	sinus bradycardia



SCPECG	D.3.2.6-EBRAD	extreme bradycardia
SCPECG	D.3.2.6-JTACH	junctional tachycardia
SCPECG	D.3.2.6-SVTAC	supraventricular tachycardia
SCPECG	D.3.2.6-JBRAD	junctional bradycardia
SCPECG	D.3.2.6-SVBRA	supraventricular bradycardia
SCPECG	D.3.2.6-WQTAC	wide QRS tachycardia
SCPECG	D.3.2.6-NQTAC	narrow QRS tachycardia
SCPECG	D.3.2.6-TACHO	tachycardia, origin unknown or not specified
SCPECG	D.3.2.6-BRADO	bradycardia, origin unknown or not specified
SCPECG	D.3.2.6-ARRHY	arrhythmia, origin unknown
SCPECG	D.3.2.6-IRREG	irregular rhythm
SCPECG	D.3.2.6-REGRH	regular rhythm
SCPECG	D.3.2.6-JESCR	junctional escape rhythm
SCPECG	D.3.2.6-VESCR	ventricular escape rhythm
SCPECG	D.3.2.6-ACAR	accelerated atrial rhythm
SCPECG	D.3.2.6-ACVR	accelerated ventricular rhythm
SCPECG	D.3.2.6-ACJR	accelerated junctional rhythm
SCPECG	D.3.2.6-AVJR	AV-junctional rhythm
SCPECG	D.3.2.6-ARHYT	atrial rhythm
SCPECG	D.3.2.6-SVRHY	supraventricular rhythm
SCPECG	D.3.2.6-JRHYT	junctional rhythm
SCPECG	D.3.2.6-VRHYT	ventricular rhythm
SCPECG	D.3.2.6-UNRHY	undetermined rhythm
SCPECG	D.3.2.6-EAR	ectopic atrial rhythm
SCPECG	D.3.2.6-LAR	left atrial rhythm
SCPECG	D.3.2.6-MAR	multifocal atrial rhythm
SCPECG	D.3.2.6-NODRH	nodal rhythm
SCPECG	D.3.2.6-RAR	low right atrial rhythm
SCPECG	D.3.2.6-LGL	Lown-Ganong-Levine syndrome
SCPECG	D.3.2.6-SHTPR	Short PR-interval
SCPECG	D.3.2.6-AFIB	atrial fibrillation
SCPECG	D.3.2.6-AFLT	atrial flutter
SCPECG	D.3.2.6-ATACH	atrial tachycardia
SCPECG	D.3.2.6-PSVT	paroxysmal supraventricular tachycardia
SCPECG	D.3.2.6-PAT	paroxysmal atrial tachycardia
SCPECG	D.3.2.6-MFAT	multifocal atrial tachycardia
SCPECG	D.3.2.6-RATAC	run of atrial tachycardia
SCPECG	D.3.2.6-RJTAC	run of junctional tachycardia
SCPECG	D.3.2.6-AVNRT	atrioventricular nodal re-entrant tachycardia
SCPECG	D.3.2.6-AVRT	atrioventricular reciprocating tachycardia
SCPECG	D.3.2.6-IDIOR	idioventricular rhythm

SCPECG	D.3.2.6-VFIB	ventricular fibrillation
SCPECG	D.3.2.6-VTACH	ventricular tachycardia
SCPECG	D.3.2.6-RVTAC	run of ventricular tachycardia
SCPECG	D.3.2.6-SVT	sustained ventricular tachycardia
SCPECG	D.3.2.6-NSVT	non-sustained ventricular tachycardia
SCPECG	D.3.2.6-TORSA	torsade des pointes ventricular tachycardia
SCPECG	D.3.2.6-MTACH	multifocal tachycardia, supraventricular or ventricular
SCPECG	D.3.2.6-VFLT	ventricular flutter
SCPECG	D.3.2.6-ASYST	asystole

**CID 3416      Respiration Rhythms**

**Context ID 3416**  
**Respiration Rhythms**  
**Type: Extensible                      Version: 20030327**

<b>Coding Scheme Designator</b>	<b>Code Value</b>	<b>Code Meaning</b>
SRT	F-21301	normal respiratory rhythm
SRT	F-21303	irregular breathing
SRT	F-20130	gasping respiration
SRT	F-21334	abnormal respiratory rhythm
SRT	F-21331	respiration intermittent

**CID 3418      Lesion Risk**

**Context ID 3418**  
**Lesion Risk**  
**Type: Extensible                      Version: 20030327**

<b>Coding Scheme Designator</b>	<b>Coding Scheme Version</b>	<b>Code Value</b>	<b>Code Meaning</b>
NCDR	2.0b	111-1	Low Risk Lesion
NCDR	2.0b	111-2	Moderate Risk Lesion
NCDR	2.0b	111-3	High Risk Lesion

**CID 3419      Findings Titles**

**Context ID 3419**  
**Findings Titles**  
**Type: Extensible                      Version: 20030327**

<b>Coding Scheme Designator</b>	<b>Code Value</b>	<b>Code Meaning</b>
DCM	121071	Finding
DCM	121073	Impression
DCM	121075	Recommendation

**CID 3421 Procedure Action**

**Context ID 3421  
Procedure Action**

**Type: Extensible Version: 20030327**

<b>Coding Scheme Designator</b>	<b>Code Value</b>	<b>Code Meaning</b>
DCM	121130	Start Procedure Action
DCM	121131	End Procedure Action
DCM	121132	Suspend Procedure Action
DCM	121133	Resume Procedure Action

**CID 3422 Device Use Actions**

**Context ID 3422  
Device Use Actions**

**Type: Extensible Version: 20030327**

<b>Coding Scheme Designator</b>	<b>Code Value</b>	<b>Code Meaning</b>
SRT	R-002F8	Device inserted into sheath
SRT	R-002F7	Device at site of interest
SRT	R-002FB	Device withdrawn / removed
SRT	R-002F6	Device applied to patient
SRT	R-002FA	Device used
SRT	R-10042	Device crossed septum
DCM	122089	Device crossed lesion

**CID 3423 Numeric Device Characteristics**

**Context ID 3423  
Numeric Device Characteristics**

**Type: Extensible Version: 20030327**

<b>Coding Scheme Designator</b>	<b>Code Value</b>	<b>Code Meaning</b>
SRT	G-A22A	Length
SRT	M-02550	Diameter
DCM	122097	Catheter Curve
DCM	122098	Transmit Frequency

**CID 3425 Intervention Parameters**

**Context ID 3425**  
**Intervention Parameters**  
Type: **Extensible**      Version: **20030327**

<b>Coding Scheme Designator</b>	<b>Code Value</b>	<b>Code Meaning</b>
SRT	R-002D0	Angioplasty Inflation pressure
SRT	R-002CF	Angioplasty Inflation duration
SRT	R-0036C	Rotational Atherectomy Speed
SRT	R-002F2	Delivered Radiation Dose
SRT	R-10043	Ablation power
SRT	R-10044	Ablation frequency

**CID 3426 Consumables Parameters**

**Context ID 3426**  
**Consumables Parameters**  
Type: **Extensible**      Version: **20030327**

<b>Coding Scheme Designator</b>	<b>Code Value</b>	<b>Code Meaning</b>
DCM	121145	Description of Material
DCM	121148	Unit Serial Identifier
DCM	121149	Lot Identifier

**CID 3427 Equipment Events**

**Context ID 3427**  
**Equipment Events**  
Type: **Extensible**      Version: **20030327**

<b>Coding Scheme Designator</b>	<b>Code Value</b>	<b>Code Meaning</b>

DCM	122046	Equipment failure
DCM	122047	Equipment brought to procedure room
DCM	122048	Equipment ready
DCM	122049	Equipment removed

**CID 3428      Imaging Procedures**

**Context ID 3428**  
**Imaging Procedures**  
**Type: Extensible      Version: 20030327**

<b>Coding Scheme Designator</b>	<b>Code Value</b>	<b>Code Meaning</b>
SRT	P5-009A0	Angiography
SRT	P5-32130	Aortography
SRT	P5-30100	Coronary Arteriography
SRT	P5-3003A	Cardiac ventriculography
SRT	P5-30041	Left Ventriculography
SRT	P5-3003F	Right Ventriculography
SRT	P5-30107	Bypass graft angiography
DCM	122058	Arterial conduit angiography
SRT	P5-B3002	Transesophageal echocardiography
SRT	P5-B3003	Transthoracic echocardiography
SRT	P5-B3004	Epicardial echocardiography
SRT	P5-B001D	Intravascular ultrasound
SRT	P5-B3006	Intracardiac echocardiography

**CID 3429      Catheterization Devices**

**Context ID 3429**  
**Catheterization Devices**  
**Type: Extensible      Version: 20030327**

<b>Coding Scheme Designator</b>	<b>Code Value</b>	<b>Code Meaning</b>
SRT	A-28051	Intra-Aortic Balloon Pump (IABP)
SRT	R-00306	Fluid filled catheter
SRT	R-00304	Fiberoptic catheter
SRT	R-0030A	Hall catheter
SRT	R-00379	Thermistor catheter
SRT	R-00383	Tip manometer
SRT	A-26860	Swann-Ganz catheter
SRT	F-9B75C	Sheath

SRT	R-10041	Transseptal catheter
DCM	122052	Bioptome
INCLUDE CID 3411 Intracoronary Devices		

**CID 3430          DateTime Qualifiers**

**Context ID 3430  
DateTime Qualifiers**

**Type: Extensible          Version: 20030327**

<b>Coding Scheme Designator</b>	<b>Code Value</b>	<b>Code Meaning</b>
DCM	121136	Datetime Unsynchronized
DCM	121137	Datetime Estimated

**CID 3440          Peripheral Pulse Locations**

**Context ID 3440  
Peripheral Pulse Locations**

**Type: Extensible          Version: 20030327**

<b>Coding Scheme Designator</b>	<b>Code Value</b>	<b>Code Meaning</b>
SRT	T-47160	Brachial Artery
SRT	T-45100	Carotid Artery
SRT	T-47741	Dorsalis Pedis Artery
SRT	T-47400	Femoral Artery
SRT	T-47500	Popliteal Artery
SRT	T-47600	Posterior Tibial Artery
SRT	T-47300	Radial Artery
SRT	T-47200	Ulnar Artery

**CID 3441          Patient assessments**

**Context ID 3441  
Patient assessments**

**Type: Extensible          Version: 20030327**

<b>Coding Scheme Designator</b>	<b>Code Value</b>	<b>Code Meaning</b>
LN	8884-9	Cardiac Rhythm
LN	9304-7	Respiration Rhythm
SRT	F-046D8	Skin condition assessment

SRT	F-043E6	Respiration assessment
SRT	F-04317	Patient mental state assessment

**CID 3442      Peripheral Pulse Methods**

**Context ID 3442**  
**Peripheral Pulse Methods**  
Type: Extensible      Version: 20030327

Coding Scheme Designator	Code Value	Code Meaning
SRT	P2-01510	Palpation
SRT	P1-30022	Doppler

**CID 3446      Skin Condition**

**Context ID 3446**  
**Skin Condition**  
Type: Extensible      Version: 20030327

Coding Scheme Designator	Code Value	Code Meaning
DCM	122271	skin condition Warm
DCM	122272	skin condition Cool
DCM	122273	skin condition Cold
DCM	122274	skin condition Dry
DCM	122275	skin condition Clammy
DCM	122276	skin condition Diaphoretic
DCM	122277	skin condition Flush
DCM	122278	skin condition Mottled
DCM	122279	skin condition Pale

**CID 3448      Airway Assessment**

**Context ID 3448**  
**Airway Assessment**  
Type: Extensible      Version: 20030327

Coding Scheme Designator	Code Value	Code Meaning
DCM	122281	airway unobstructed
DCM	122282	airway partially obstructed
DCM	122283	airway severely obstructed

**CID 3451 Calibration Objects**

**Context ID 3451  
Calibration Objects**

**Type: Extensible Version: 20040614**

<b>Coding Scheme Designator (0008,0102)</b>	<b>Code Value (0008,0100)</b>	<b>Code Meaning (0008,0104)</b>
SRT	A-26800	Catheter
SRT	A-10141	Measuring Ruler
DCM	122485	Sphere

**CID 3452 Calibration Methods**

**Context ID 3452  
Calibration Methods**

**Type: Extensible Version: 20040614**

<b>Coding Scheme Designator (0008,0102)</b>	<b>Code Value (0008,0100)</b>	<b>Code Meaning (0008,0104)</b>
DCM	122486	Geometric Isocenter
DCM	122487	Geometric Non-Isocenter
DCM	122488	Calibration Object Used

**CID 3453 Volume Methods**

**Context ID 3453  
Volume Methods**

**Type: Extensible Version: 20040614**

<b>Coding Scheme Designator (0008,0102)</b>	<b>Code Value (0008,0100)</b>	<b>Code Meaning (0008,0104)</b>
DCM	122558	Area Length Kennedy
DCM	122559	Area Length Dodge
DCM	122560	Area Length Wynne
DCM	122562	Multiple Slices
DCM	122563	Boak
DCM	122564	TS Pyramid
DCM	122565	Two Chamber
DCM	122566	Parallelepiped



**CID 3455 Index Methods**

**Context ID 3455  
Index Methods**

**Type: Extensible                      Version: 20040614**

<b>Coding Scheme Designator (0008,0102)</b>	<b>Code Value (0008,0100)</b>	<b>Code Meaning (0008,0104)</b>
LN	8277-6	BSA
DCM	122572	BSA^1.219

**CID 3456 Sub-segment Methods**

**Context ID 3456  
Sub-Segment Methods**

**Type: Extensible                      Version: 20040614**

<b>Coding Scheme Designator (0008,0102)</b>	<b>Code Value (0008,0100)</b>	<b>Code Meaning (0008,0104)</b>
DCM	122574	Equidistant method
DCM	122575	User selected method

**CID 3458 Contour Realignment**

**Context ID 3458  
Contour Realignment**

**Type: Extensible                      Version: 20040614**

<b>Coding Scheme Designator (0008,0102)</b>	<b>Code Value (0008,0100)</b>	<b>Code Meaning (0008,0104)</b>
DCM	122475	Center of Gravity
DCM	122476	Long Axis Based
DCM	122477	No Realignment

**CID 3460 Circumferential Extent**

**Context ID 3460  
Circumferential Extent**

**Type: Extensible                      Version: 20040614**

<b>Coding Scheme Designator (0008,0102)</b>	<b>Code Value (0008,0100)</b>	<b>Code Meaning (0008,0104)</b>
DCM	122464	LAD Region in RAO Projection
DCM	122465	RCA Region in RAO Projection

**CID 3461 Regional Extent**

**Context ID 3461  
Regional Extent**

**Type: Extensible Version: 20040614**

<b>Coding Scheme Designator (0008,0102)</b>	<b>Code Value (0008,0100)</b>	<b>Code Meaning (0008,0104)</b>
DCM	122466	Single LAD Region in RAO Projection
DCM	122467	Single RCA Region in RAO Projection
DCM	122468	Multiple LAD Region in RAO Projection
DCM	122469	Multiple RCA Region in RAO Projection
DCM	122470	LAD Region in LAO Projection
DCM	122471	RCA Region in LAO Projection
DCM	122472	CFX Region in LAO Projection

**CID 3462 Chamber Identification**

**Context ID 3462  
Chamber Identification**

**Type: Extensible Version: 20040614**

<b>Coding Scheme Designator (0008,0102)</b>	<b>Code Value (0008,0100)</b>	<b>Code Meaning (0008,0104)</b>
SRT	T-32600	Left Ventricle
SRT	T-32500	Right Ventricle
SRT	T-32300	Left Atrium
SRT	T-32200	Right Atrium

**CID 3465 QA Reference Methods**

**Context ID 3465  
QA Reference Methods**

**Type: Extensible Version: 20040614**

<b>Coding Scheme Designator (0008,0102)</b>	<b>Code Value (0008,0100)</b>	<b>Code Meaning (0008,0104)</b>
DCM	122489	Curve Fitted Reference
DCM	122490	Interpolated Local Reference
DCM	122491	Mean Local Reference

**CID 3466 Plane Identification**

**Context ID 3466  
Plane Identification**

**Type: Extensible**

**Version: 20040614**

<b>Coding Scheme Designator (0008,0102)</b>	<b>Code Value (0008,0100)</b>	<b>Code Meaning (0008,0104)</b>
SRT	R-10218	Right Anterior Oblique
SRT	R-10220	Left Anterior Oblique
SRT	R-10206	Antero-posterior
SRT	R-10236	Left Lateral
SRT	R-101C3	Cranial LAO
SRT	R-101C5	Cranial RAO
SRT	R-101C4	Caudal LAO
SRT	R-101C6	Caudal RAO

**CID 3467 Ejection Fraction**

**Context ID 3467  
Ejection Fraction**

**Type: Extensible**

**Version: 20040614**

<b>Coding Scheme Designator (0008,0102)</b>	<b>Code Value (0008,0100)</b>	<b>Code Meaning (0008,0104)</b>
LN	8808-8	Left Ventricular Ejection Fraction by Angiography
LN	8815-3	Right Ventricular Ejection Fraction by Angiography
DCM	122406	Left Atrial Ejection Fraction by Angiography

**CID 3468      ED Volume**

**Context ID 3468  
ED Volume**

**Type: Extensible      Version: 20040614**

<b>Coding Scheme Designator (0008,0102)</b>	<b>Code Value (0008,0100)</b>	<b>Code Meaning (0008,0104)</b>
LN	8821-1	Left Ventricular ED Volume
LN	8822-3	Right Ventricular ED Volume
DCM	122407	Left Atrial ED Volume

**CID 3469      ES Volume**

**Context ID 3469  
ES Volume**

**Type: Extensible      Version: 20040614**

<b>Coding Scheme Designator (0008,0102)</b>	<b>Code Value (0008,0100)</b>	<b>Code Meaning (0008,0104)</b>
LN	8823-7	Left Ventricular ES Volume
LN	8824-5	Right Ventricular ES Volume
DCM	122408	Left Atrial ES Volume

**CID 3470      Vessel Lumen Cross-Sectional Area Calculation Methods**

**Context ID 3470  
Vessel Lumen Cross-Sectional Area Calculation Methods**

**Type: Extensible      Version: 20040614**

<b>Coding Scheme Designator (0008,0102)</b>	<b>Code Value (0008,0100)</b>	<b>Code Meaning (0008,0104)</b>
DCM	122473	Circular method
DCM	122474	Densitometric method

**CID 3471      Estimated Volumes**

**Context ID 3471  
Estimated Volumes**

**Type: Extensible      Version: 20040614**

<b>Coding Scheme Designator (0008,0102)</b>	<b>Code Value (0008,0100)</b>	<b>Code Meaning (0008,0104)</b>
DCM	121216	Volume estimated from single 2D region
DCM	121218	Volume estimated from two non-coplanar 2D regions

**CID 3472 Contraction Phase**

**Context ID 3472  
Contraction Phase**

**Type: Extensible**

**Version: 20040614**

<b>Coding Scheme Designator (0008,0102)</b>	<b>Code Value (0008,0100)</b>	<b>Code Meaning (0008,0104)</b>
DCM	F-32020	Systolic
DCM	F-32010	Diastolic

**CID 3480 IVUS Procedure Phases**

This context group outlines the phases of a catheterization procedure in which measurements are performed.

**Context ID 3480  
IVUS Procedure Phases**

**Type: Extensible**

**Version: 20040614**

<b>Code Scheme</b>	<b>Code Value</b>	<b>Concept Name</b>
SRT	G-7298	Cardiac catheterization post-intervention phase
SRT	G-7296	Cardiac catheterization pre-intervention phase

**CID 3481 IVUS Distance Measurements**

This context group is the set of distance measurements made in an IVUS procedure.

**Context ID 3481  
IVUS Distance Measurements**

**Type: Extensible**

**Version: 20050110**

<b>Code Scheme</b>	<b>Code Value</b>	<b>Concept Name</b>
DCM	122330	EEM Diameter
SRT	G-0364	Vessel lumen diameter
SRT	R-101AD	Stent Diameter
DCM	122331	Plaque Plus Media Thickness
DCM	122332	Lumen Perimeter

**CID 3482 IVUS Area Measurements**

This context group is the set of cross-sectional area measurements made in an IVUS procedure.

**Context ID 3482**

**IVUS Area Measurements**

**Type: Extensible**

**Version: 20040614**

Code Scheme	Code Value	Concept Name
DCM	122333	EEM Cross-Sectional Area
SRT	G-0366	Vessel lumen cross-sectional area
SRT	R-101AF	Stent Cross-Sectional Area
DCM	122334	Plaque plus Media Cross-Sectional Area
DCM	122335	In-Stent Neointimal Cross-Sectional Area

**CID 3483 IVUS Longitudinal Measurements**

This context group is a set of measurements that are made on a longitudinal image. A longitudinal image is a perpendicular cut plane reconstructed from an IVUS pullback multi-frame image.

**Context ID 3483**

**IVUS Longitudinal Measurements**

**Type: Extensible**

**Version: 20050110**

Code Scheme	Code Value	Concept Name
SRT	R-101B0	Stent Length
SRT	R-101BC	Stenotic Lesion Length
DCM	122341	Calcium Length
DCM	122364	Stent Gap

**CID 3484 IVUS Indices and Ratios**

This context group is the set of index and ratio calculations made in an IVUS procedure.

**Context ID 3484**

**IVUS Indices and Ratios**

**Type: Extensible**

**Version: 20040614**

Code Scheme	Code Value	Concept Name
DCM	122343	Lumen Eccentricity Index
DCM	122344	Plaque plus Media Eccentricity Index
DCM	122345	Remodeling Index
DCM	122346	Stent Symmetry Index
DCM	122347	Stent Expansion Index
DCM	122348	Lumen Shape Index
DCM	122350	Lumen Diameter Ratio

DCM	122351	Stent Diameter Ratio
DCM	122352	EEM Diameter Ratio

**CID 3485 IVUS Volume Measurements**

This context group is the set of volume measurements made from an IVUS procedure.

**Context ID 3485**

**IVUS Volume Measurements**

**Type: Extensible**

**Version: 20040614**

Code Scheme	Code Value	Concept Name
DCM	122371	EEM Volume
DCM	122372	Lumen Volume
SRT	R-101B2	Stent Volume
DCM	122374	In-Stent Neointimal Volume
DCM	122375	Native Plaque Volume
DCM	122376	Total Plaque Volume

**CID 3486 Vascular Measurement Sites**

This context group is the set of sites where vascular measurements can be made.

**Context ID 3486**

**Vascular Measurement Sites**

**Type: Extensible**

**Version: 20051103**

Code Scheme	Code Value	Concept Name
DCM	122380	Proximal Reference
DCM	122381	Distal Reference
DCM	122382	Site of Lumen Minimum
DCM	122687	Site of Lumen Maximum

**CID 3487 IVUS Volumetric Regions**

This context group is the set of regions where IVUS volumetric measurements can be made.

**Context ID 3487**

**IVUS Volumetric Regions**

**Type: Extensible**

**Version: 20040614**

Code Scheme	Code Value	Concept Name
DCM	122383	Stented Region
DCM	122384	Entire Pullback
DCM	122385	Proximal Stent Margin

DCM	122386	Distal Stent Margin
SRT	M-01000	Lesion

**CID 3488 Min/Max/Mean**

This context group contains modifiers that indicate whether the measurement is a minimum, maximum or averaged value.

**Context ID 3488**

**Min/Max/Mean**

**Type: Extensible**

**Version: 20040614**

Code Scheme	Code Value	Concept Name
SRT	G-A437	Maximum
SRT	R-404FB	Minimum
SRT	R-00317	Mean

**CID 3489 Calcium Distribution**

This context group is a set of modifiers specifying the distribution of a calcium deposit in an arc of calcium measurement.

**Context ID 3489**

**Calcium Distribution**

**Type: Extensible**

**Version: 20040614**

Code Scheme	Code Value	Concept Name
SRT	G-A139	Superficial
SRT	G-A140	Deep

**CID 3491 IVUS Lesion Morphologies**

This context group is a set of qualitative assessments for lesion morphology.

**Context ID 3491**

**IVUS Lesion Morphologies**

**Type: Extensible**

**Version: 20040614**

Code Scheme	Code Value	Concept Name
Include CID 3495		
DCM	122356	Soft plaque
DCM	122357	In-Stent Neointima
SRT	D3-80027	Arterial (True) Aneurysm
SRT	M-32390	Pseudo Aneurysm
DCM	122361	False Lumen



SRT	R-4047B	Concentric
SRT	R-40416	Eccentric
SRT	M-52103	Plaque Ulceration
DCM	122363	Plaque Rupture
DCM	122389	Vulnerable Plaque
DCM	122390	Eroded Plaque

**CID 3492 Vascular Dissection Classifications**

This context group is a set of dissection classifications commonly detected with IVUS or CT/MR angiography.

**Context ID 3492**

**Vascular Dissection Classifications**

**Type: Extensible**

**Version: 20040614**

Code Scheme	Code Value	Concept Name
SRT	R-101B7	Medial Dissection
SRT	R-101B8	Intimal Dissection
SRT	R-101B9	Adventitial Dissection
SRT	M-35063	Intramural hematoma
DCM	122388	Intra-stent Dissection

**CID 3493 IVUS Relative Stenosis Severities**

This context group is a set of stenosis severity classifications for multiple lesions within a segment. There will always be a worst stenosis (T-1), the stenosis with the smallest lumen size.

There can be multiple secondary stenoses (T-2, T-3, etc.), which are lesions meeting the definition of a stenosis, but with lumen sizes larger than the worst stenosis. Reference *"American College of Cardiology Clinical Expert Consensus Document on Standards for Acquisition, Measurement and Reporting of Intravascular Ultrasound Studies (IVUS)"*.

**Context ID 3493**

**IVUS Relative Stenosis Severities**

**Type: Extensible**

**Version: 20040614**

Code Scheme	Code Value	Concept Name
DCM	122367	T-1 Worst
DCM	122368	T-2 Secondary
DCM	122369	T-3 Secondary
DCM	122370	T-4 Secondary

**CID 3494 IVUS Non Morphological Findings**

**Context ID 3494**

**IVUS Non Morphological Findings**

**Type: Extensible**

**Version: 20040614**

<b>Code Scheme</b>	<b>Code Value</b>	<b>Concept Name</b>
DCM	122360	True Lumen
SRT	R-101B3	Arterial Blood Stasis
SRT	R-101B5	Incomplete Stent apposition
SRT	R-101B6	Acquired Incomplete stent apposition

**CID 3495 IVUS Plaque Composition**

This context group is a set of qualitative assessments defining the composition of plaque.

**Context ID 3495**

**IVUS Plaque Composition**

**Type: Extensible**

**Version: 20040614**

<b>Code Scheme</b>	<b>Code Value</b>	<b>Concept Name</b>
SRT	M-78260	Fibrous Plaque
SRT	D6-34737	Vascular Calcification
SRT	M-35001	Thrombus
DCM	122394	Fibro-Lipidic Plaque
DCM	122395	Necrotic-Lipidic Plaque

**CID 3496 IVUS Fiducial Points**

This context group is a set of fiducial points (anatomical markers). Fiducial points are used as identifiable axial landmarks in determining the location of a measurement in a vessel.

**Context ID 3496**

**IVUS Fiducial Points**

**Type: Extensible**

**Version: 20040614**

<b>Code Scheme</b>	<b>Code Value</b>	<b>Concept Name</b>
SRT	G-035D	Collateral Branch of vessel
SRT	A-25500	Stent
SRT	D6-34737	Vascular Calcification
SRT	M-78260	Fibrous Plaque
SRT	T-48000	Vein
SRT	G-036A	Vessel Origin

**CID 3497 IVUS Arterial Morphology**

**Context ID 3497  
IVUS Arterial Morphology**

**Type: Extensible Version: 20050110**

<b>Coding Scheme</b>	<b>Code Value</b>	<b>Code Meaning</b>
SRT	T-41100	Lumen of artery
SRT	R-102AE	External Elastic Membrane
<i>Include CID 3495</i>		

**CID 3500 Pressure Units**

**Context ID 3500  
Pressure Units**

**Type: Non-Extensible Version: 20030327**

<b>Coding Scheme Designator</b>	<b>Code Value</b>	<b>Code Meaning</b>
UCUM	mm[Hg]	mmHg
UCUM	Kpa	kPa

**CID 3502 Hemodynamic Resistance Units**

**Context ID 3502  
Hemodynamic Resistance Units**

**Type: Non-Extensible Version: 20030327**

<b>Coding Scheme Designator</b>	<b>Code Value</b>	<b>Code Meaning</b>
UCUM	[PRU]	Wood units
UCUM	dyn.s.cm-5	dyn.s.cm-5

**CID 3503 Indexed Hemodynamic Resistance Units**

**Context ID 3503  
Indexed Hemodynamic Resistance Units**

**Type: Non-Extensible Version: 20030327**

<b>Coding Scheme Designator</b>	<b>Code Value</b>	<b>Code Meaning</b>
UCUM	[PRU].m2	Wood units * m2
UCUM	dyn.s.cm-5.m2	dyn.s.cm-5 * m2

**CID 3510 Catheter Size Units**

**Context ID 3510  
Catheter Size Units**

**Type: Extensible Version: 20030327**

- Standard -

<b>Coding Scheme Designator</b>	<b>Code Value</b>	<b>Code Meaning</b>
UCUM	[Ch]	French
UCUM	Mm	mm

**CID 3515 Specimen Collection**

**Context ID 3515**  
**Specimen Collection**  
Type: Extensible Version: 20030327

<b>Coding Scheme Designator</b>	<b>Code Value</b>	<b>Code Meaning</b>
SRT	P3-02000	specimen collection
SRT	PA-20110	collection of blood specimen for laboratory
SRT	PA-2011E	blood sampling from extracorporeal blood circuit

**CID 3520 Blood Source Type**

**Context ID 3520**  
**Blood Source Type**  
Type: Extensible Version: 20030327

<b>Coding Scheme Designator</b>	<b>Code Value</b>	<b>Code Meaning</b>
SRT	R-00376	Systemic Artery Blood
SRT	T-C2007	Mixed Venous Blood
SRT	R-0035B	Pulmonary Artery Blood
SRT	R-0035E	Pulmonary Vein Blood

**CID 3524 Blood Gas Pressures**

**Context ID 3524**  
**Blood Gas Pressures**  
Type: Extensible Version: 20030327

<b>Coding Scheme Designator</b>	<b>Code Value</b>	<b>Code Meaning</b>
LN	11557-6	Blood Carbon dioxide partial pressure
LN	2019-8	Arterial Blood Carbon dioxide partial pressure
LN	2021-4	Venous Blood Carbon dioxide partial pressure
LN	11556-8	Blood Oxygen partial pressure
LN	2703-7	Arterial Oxygen partial pressure
LN	2705-2	Venous Oxygen partial pressure

LN	19217-9	Oxygen partial pressure at 50% saturation (P50)
LN	19214-6	Arterial Oxygen partial pressure at 50% saturation
LN	19216-1	Venous Oxygen partial pressure at 50% saturation

**CID 3525 Blood Gas Content**

**Context ID 3525  
Blood Gas Content  
Type: Extensible Version: 20030327**

<b>Coding Scheme Designator</b>	<b>Code Value</b>	<b>Code Meaning</b>
LN	20565-8	Blood Carbon dioxide content
LN	2026-3	Arterial Blood Carbon dioxide content
LN	2027-1	Venous Blood Carbon dioxide content
DCM	122185	Blood Oxygen content
LN	19218-7	Arterial Oxygen content
LN	19220-3	Venous Oxygen content
LN	10232-7	Aortic Root Oxygen content
LN	10245-9	Pulmonary Artery Main Oxygen content
LN	10247-5	Pulmonary Wedge Oxygen content

**CID 3526 Blood Gas Saturation**

**Context ID 3526  
Blood Gas Saturation  
Type: Extensible Version: 20030327**

<b>Coding Scheme Designator</b>	<b>Code Value</b>	<b>Code Meaning</b>
DCM	122187	Blood Carbon dioxide saturation
LN	20564-1	Blood Oxygen saturation
LN	2708-6	Arterial Oxygen saturation
LN	2711-0	Venous Oxygen saturation
LN	2709-4	Capillary Blood Oxygen Saturation
LN	2710-2	Capillary Blood Oxygen Saturation, by Oximetry

**CID 3527 Blood Base Excess**

**Context ID 3527  
Blood Base Excess  
Type: Extensible Version: 20030327**

Coding Scheme Designator	Code Value	Code Meaning
LN	11555-0	Blood Base Excess
LN	1925-7	Arterial Blood Base Excess
LN	1927-3	Venous Blood Base Excess

**CID 3528 Blood pH**

**Context ID 3528  
Blood pH**

**Type: Extensible Version: 20030327**

Coding Scheme Designator	Code Value	Code Meaning
LN	11558-4	Blood pH
LN	2744-1	Arterial Blood pH
LN	2746-6	Venous Blood pH

**CID 3529 Arterial / Venous Content**

**Context ID 3529  
Arterial / Venous Content**

**Type: Extensible Version: 20030327**

Coding Scheme Designator	Code Value	Code Meaning
LN	19218-7	Arterial Content (FCa)
LN	19220-3	Venous Content (FCv)
DCM	122188	Pulmonary Arterial Content (FCpa)
DCM	122189	Pulmonary Venous Content (FCpv)

**CID 3530 Oxygen Administration Actions**

**Context ID 3530  
Oxygen Administration Actions**

**Type: Extensible Version: 20030327**

Coding Scheme Designator	Code Value	Code Meaning
DCM	121161	Begin oxygen administration
DCM	121162	End oxygen administration

**CID 3531      Oxygen Administration**

**Context ID 3531  
Oxygen Administration**

**Type: Extensible      Version: 20030327**

<b>Coding Scheme Designator</b>	<b>Code Value</b>	<b>Code Meaning</b>
SRT	R-0034A	Oxygen Administration by nasal canula
SRT	R-00349	Oxygen Administration by mask
DCM	121163	Oxygen Administration by ventilator

**CID 3550      Circulatory Support Actions**

**Context ID 3550  
Circulatory Support Actions**

**Type: Extensible      Version: 20030327**

<b>Coding Scheme Designator</b>	<b>Code Value</b>	<b>Code Meaning</b>
DCM	121157	Begin Circulatory Support
DCM	121158	End Circulatory Support

**CID 3551      Ventilation Actions**

**Context ID 3551  
Ventilation Actions**

**Type: Extensible      Version: 20030327**

<b>Coding Scheme Designator</b>	<b>Code Value</b>	<b>Code Meaning</b>
DCM	121168	Begin Ventilation
DCM	121169	End Ventilation

**CID 3552      Pacing Actions**

**Context ID 3552  
Pacing Actions**

**Type: Extensible      Version: 20030327**

<b>Coding Scheme Designator</b>	<b>Code Value</b>	<b>Code Meaning</b>
DCM	121166	Begin Pacing
DCM	121167	End Pacing

**CID 3553      Circulatory Support**

**Context ID 3553  
Circulatory Support**

**Type: Extensible      Version: 20030327**

<b>Coding Scheme Designator</b>	<b>Code Value</b>	<b>Code Meaning</b>
SRT	A-28051	Intra-Aortic Balloon Pump
SRT	R-00303	External Counter-Pulsation
SRT	A-11FCD	Left Ventricular Assist Device
SRT	P2-77110	Extra-corporeal circulation
SRT	P1-36858	Cardiopulmonary bypass

**CID 3554      Ventilation**

**Context ID 3554  
Ventilation**

**Type: Extensible      Version: 20030327**

<b>Coding Scheme Designator</b>	<b>Code Value</b>	<b>Code Meaning</b>
SRT	R-002CC	Ambu Bag
SRT	R-00359	Pressure Support Ventilator
SRT	R-0038C	Volume Support Ventilator

**CID 3555      Pacing**

**Context ID 3555  
Pacing**

**Type: Extensible      Version: 20030327**



Coding Scheme Designator	Code Value	Code Meaning
SRT	P2-35000	Pacing
SRT	R-00315	pacing with magnet
SRT	P2-35200	atrial pacing
SRT	P2-35002	ventricular pacing
SRT	R-002D9	A-V sequential pacing
SRT	P2-35440	temporary transcutaneous pacing

**CID 3560 Blood Pressure Methods**

**Context ID 3560  
Blood Pressure Methods**

**Type: Extensible Version: 20030327**

Coding Scheme Designator	Code Value	Code Meaning
SRT	R-00318	Blood pressure cuff method

**CID 3600 Relative times**

**Context ID 3600  
Relative times**

**Type: Non-Extensible Version: 20030327**

Coding Scheme Designator	Code Value	Code Meaning
SRT	R-407E0	Before
SRT	R-407E1	During
SRT	R-42517	After

**CID 3602 Hemodynamic Patient State**

**Context ID 3602  
Hemodynamic Patient State**

**Type: Extensible Version: 20030327**

<b>Coding Scheme Designator</b>	<b>Code Value</b>	<b>Code Meaning</b>
SRT	F-01602	Baseline state
SRT	F-10340	Supine body position
SRT	F-01604	Resting state
SRT	F-01606	Exercise state
SRT	F-01608	Post-exercise state

**CID 3604 Arterial lesion locations**

**Context ID 3604  
Arterial lesion locations**

**Type: Extensible Version: 20030327**

<b>Coding Scheme Designator</b>	<b>Code Value</b>	<b>Code Meaning</b>
INCLUDE CID 3015 Coronary Arteries		
INCLUDE CID 3606 Arterial source locations		

**CID 3606 Arterial source locations**

**Context ID 3606  
Arterial source locations  
Type: Extensible Version: 20061024**

<b>Coding Scheme Designator</b>	<b>Code Value</b>	<b>Code Meaning</b>
SRT	T-42500	Abdominal aorta
SRT	T-45530	anterior communicating artery
SRT	T-45730	anterior spinal artery
SRT	T-42000	Aorta
SRT	T-42300	Aortic Arch
SRT	D3-81922	Aortic fistula
SRT	T-41000	Artery
SRT	T-42100	Ascending aorta
SRT	T-47100	Axillary Artery
SRT	A-00203	Baffle
SRT	T-45800	basilar artery
SRT	T-47160	Brachial artery
SRT	T-46010	brachiocephalic trunk
SRT	T-45010	Carotid Artery

SRT	T-45510	cerebral artery
SRT	T-45100	Common carotid artery
SRT	T-43000	Coronary Artery
SRT	T-42400	Descending aorta
SRT	T-45240	facial artery
SRT	T-47400	Femoral artery
SRT	D4-32504	Fistula coronary to left atrium
SRT	D4-32506	Fistula coronary to left ventricle
SRT	D4-32508	Fistula coronary to right atrium
SRT	D4-32510	Fistula coronary to right ventricle
SRT	T-47490	geniculate artery
SRT	T-46420	Hepatic artery
SRT	T-46700	Iliac artery
SRT	T-46010	Innominate artery
SRT	T-45300	internal carotid artery
SRT	T-46200	Internal mammary artery
SRT	T-45410	lacrimal artery
SRT	T-47651	lateral plantar artery
SRT	T-44400	Left pulmonary artery
SRT	T-45230	lingual artery
SRT	T-46960	lumbar artery
SRT	T-46500	mesenteric artery
SRT	T-47661	medial plantar artery
SRT	T-F7001	Neo-aorta (primitive aorta)
SRT	T-F7040	Neonatal pulmonary artery (primitive PA)
SRT	T-45250	occipital artery
SRT	T-45400	ophthalmic artery
SRT	D4-32012	patent ductus arteriosus
SRT	T-47630	peroneal artery
SRT	T-47500	popliteal artery
SRT	T-45320	posterior communicating artery
SRT	R-F5517	Pulmonary arteriovenous fistula
SRT	T-44000	Pulmonary artery
SRT	D4-33142	Pulmonary artery conduit
SRT	R-00360	Pulmonary vein wedge
SRT	T-47300	radial artery
SRT	T-46600	Renal artery
SRT	T-47410	Right femoral artery
SRT	T-44200	Right pulmonary artery
SRT	T-46100	Subclavian Artery
SRT	T-45270	superficial temporal artery

SRT	T-45210	superior thyroid artery
SRT	T-44007	Systemic collateral Artery to lung
SRT	T-42070	Thoracic aorta
SRT	T-4704C	tibial artery
SRT	D4-31400	Truncus Arteriosus Communis
SRT	T-F1810	Umbilical artery
SRT	T-45700	Vertebral artery

**CID 3607 Venous Source locations**

**Context ID 3607**  
**Venous Source locations**  
**Type: Extensible Version: 20061024**

<b>Coding Scheme Designator</b>	<b>Code Value</b>	<b>Code Meaning</b>
SRT	T-48503	Anomalous pulmonary vein
SRT	T-49215	Antecubital Vein
SRT	T-49110	Axillary vein
SRT	T-48340	Azygos vein
SRT	T-48052	Basilic vein
SRT	T-49424	Boyd perforating vein
SRT	T-49350	Brachial vein
SRT	T-48003	Central venous system
SRT	T-49240	cephalic vein
SRT	T-49429	Dodd perforating vein
SRT	T-49410	Femoral vein
SRT	T-48820	gastric vein
SRT	T-48720	hepatic vein
SRT	T-4942A	Hunterian perforating vein
SRT	T-48710	Inferior Vena cava
SRT	T-48620	Innominate vein
SRT	T-48170	Internal jugular vein
SRT	T-4884A	mesenteric vein
SRT	T-48810	portal vein
SRT	T-49535	posterior medial tributary
SRT	T-48500	Pulmonary vein
SRT	D4-33512	Pulmonary vein confluence
SRT	T-48740	Renal vein
SRT	T-D930A	Saphenofemoral junction
SRT	T-49530	Saphenous vein
SRT	T-48890	splenic vein

SRT	T-48330	Subclavian vein
SRT	T-48610	Superior vena cava
SRT	T-48817	Umbilical vein
SRT	T-48000	Vein
SRT	R-003AA	Vena anonyma

**CID 3608      Atrial source locations**

**Context ID 3608  
Atrial source locations**

**Type: Extensible      Version: 20030327**

<b>Coding Scheme Designator</b>	<b>Code Value</b>	<b>Code Meaning</b>
SRT	A-00203	Baffle
SRT	D4-31320	Common atrium
SRT	T-32320	Coronary sinus
SRT	D4-31052	Juxtaposed appendage
SRT	T-32300	Left atrium
SRT	G-DB27	Pulmonary artery wedge
SRT	G-DB26	Pulmonary capillary wedge
SRT	D4-33514	Pulmonary venous atrium
SRT	T-32190	Pulmonary chamber in cor triatriatum
SRT	T-32200	Right Atrium
SRT	D4-33516	Systemic venous atrium

**CID 3609      Ventricular source locations**

**Context ID 3609  
Ventricular source locations**

**Type: Extensible      Version: 20030327**

<b>Coding Scheme Designator</b>	<b>Code Value</b>	<b>Code Meaning</b>
SRT	T-32400	Common ventricle
SRT	T-32600	Left ventricle
SRT	T-32602	Left ventricle apex
SRT	T-32640	Left ventricle inflow
SRT	D4-31022	Left ventricle outflow chamber
SRT	T-32650	Left ventricle outflow tract
SRT	T-32500	Right ventricle
SRT	T-32502	Right ventricle apex
SRT	T-32540	Right ventricle inflow

SRT	D4-31032	Right ventricle outflow chamber
SRT	T-32550	Right ventricle outflow tract

**CID 3610 Gradient Source Locations**

**Context ID 3610**  
**Gradient Source Locations**  
**Type: Extensible Version: 20030327**

<b>Coding Scheme Designator</b>	<b>Code Value</b>	<b>Code Meaning</b>
SRT	T-35300	Mitral Valve
SRT	T-35400	Aortic Valve
SRT	T-35100	Tricuspid valve
SRT	T-35200	Pulmonary valve
SRT	T-44000	Pulmonary artery
SRT	T-32650	Left ventricle outflow tract
SRT	T-32550	Right ventricle outflow tract
SRT	D4-31150	Ventricular Septal defect
SRT	D4-31220	Atrial Septal defect
SRT	D4-32014	Coarctation of aorta

**CID 3611 Pressure Measurements**

**Context ID 3611**  
**Pressure Measurements**  
**Type: Extensible Version: 20050322**

<b>Coding Scheme Designator</b>	<b>Code Value</b>	<b>Code Meaning</b>
DCM	109016	A wave peak pressure
DCM	122196	C wave pressure
LN	8462-4	Intravascular diastolic blood pressure
SRT	F-00E22	Average diastolic blood pressure
SRT	F-00E1F	Minimum diastolic blood pressure
DCM	122191	Ventricular End Diastolic pressure
DCM	122197	Gradient pressure, average
DCM	122198	Gradient pressure, peak
SRT	F-31150	Mean blood pressure
DCM	122199	Pressure at dp/dt max
LN	8480-6	Intravascular Systolic Blood pressure
SRT	F-00E14	Average systolic blood pressure
SRT	F-00E11	Maximum systolic blood pressure

DCM	109034	V wave peak pressure
DCM	122208	x-descent pressure
DCM	122209	y-descent pressure
DCM	122210	z-point pressure

**CID 3612 Blood Velocity Measurements**

**Context ID 3612**  
**Blood Velocity Measurements**  
Type: Extensible Version: 20030327

Coding Scheme Designator	Code Value	Code Meaning
DCM	122201	Diastolic blood velocity, mean
DCM	122202	Diastolic blood velocity, peak
DCM	122203	Systolic blood velocity, mean
DCM	122204	Systolic blood velocity, peak
DCM	122205	Blood velocity, mean
DCM	122206	Blood velocity, minimum
DCM	122207	Blood velocity, peak

**CID 3613 Hemodynamic Time Measurements**

**Context ID 3613**  
**Hemodynamic Time Measurements**  
Type: Extensible Version: 20030327

Coding Scheme Designator	Code Value	Code Meaning
DCM	122182	R-R interval
DCM	109072	Tau
DCM	122211	Left Ventricular ejection time
DCM	122212	Left Ventricular filling time
DCM	122213	Right Ventricular ejection time
DCM	122214	Right Ventricular filling time
DCM	109071	Indicator mean transit time

**CID 3614 Valve Areas, non-Mitral**

**Context ID 3614**  
**Valve Areas, non-Mitral**  
Type: Extensible Version: 20030327

<b>Coding Scheme Designator</b>	<b>Code Value</b>	<b>Code Meaning</b>
SRT	F-0231F	Aortic Valve Area
SRT	F-02321	Pulmonic Valve Area
SRT	F-02322	Tricuspid Valve Area
DCM	122160	Derived Non-Valve Area

**CID 3615      Valve Areas**

**Context ID 3615  
Valve Areas**

**Type: Extensible      Version: 20030327**

<b>Coding Scheme Designator</b>	<b>Code Value</b>	<b>Code Meaning</b>
Include CID 3614 Valve Areas, non-Mitral		
SRT	F-02320	Mitral Valve Area

**CID 3616      Hemodynamic Period Measurements**

**Context ID 3616  
Hemodynamic Period Measurements**

**Type: Extensible      Version: 20030327**

<b>Coding Scheme Designator</b>	<b>Code Value</b>	<b>Code Meaning</b>
SRT	R-002D2	Aortic Systolic Ejection Period (SEPa)
SRT	R-0035C	Pulmonary Systolic Ejection Period (SEPP)
SRT	R-0032C	Mitral Diastolic Filling Period (DFPm)
SRT	R-003A9	Tricuspid Diastolic Filling Period (DFPt)
SRT	R-002F5	Derived Period, Non-Valve

**CID 3617      Valve Flows**

**Context ID 3617  
Valve Flows**

**Type: Extensible      Version: 20030327**

<b>Coding Scheme Designator</b>	<b>Code Value</b>	<b>Code Meaning</b>
SRT	R-002D3	Aortic Valve Flow
SRT	R-0032D	Mitral Valve Flow
SRT	R-0035D	Pulmonary Valve Flow



SRT	R-00385	Tricuspid Valve Flow
SRT	R-00394	Derived Flow, Non-Valve

**CID 3618 Hemodynamic Flows**

**Context ID 3618**  
**Hemodynamic Flows**  
Type: Extensible Version: 20030327

Coding Scheme Designator	Code Value	Code Meaning
DCM	122161	Pulmonary Flow
DCM	122162	Systemic Flow

**CID 3619 Hemodynamic Resistance Measurements**

**Context ID 3619**  
**Hemodynamic Resistance Measurements**  
Type: Extensible Version: 20030327

Coding Scheme Designator	Code Value	Code Meaning
SRT	F-03E86	Pulmonary Vascular Resistance
SRT	F-03E7E	Systemic Vascular Resistance
DCM	122215	Total Pulmonary Resistance
DCM	122216	Total Vascular Resistance

**CID 3620 Hemodynamic Ratios**

**Context ID 3620**  
**Hemodynamic Ratios**  
Type: Extensible Version: 20030327

Coding Scheme Designator	Code Value	Code Meaning
LN	8581-1	Tibial/brachial index
SRT	F-0238B	Pulmonary/Systemic Flow Ratio
DCM	122217	Coronary Flow reserve
DCM	122218	Diastolic/Systolic velocity ratio
DCM	122219	Hyperemic ratio
SRT	F-031A2	Pulsatility Index
DCM	122220	Hemodynamic Resistance Index
INCLUDE CID 3621 Fractional Flow Reserve		

**CID 3621      Fractional Flow Reserve**

**Context ID 3621**  
**Fractional Flow Reserve**  
**Type: Extensible      Version: 20030327**

<b>Coding Scheme Designator</b>	<b>Code Value</b>	<b>Code Meaning</b>
SRT	R-00307	Fractional flow reserve
SRT	R-00308	Fractional Flow Reserve using intracoronary bolus
SRT	R-00309	Fractional Flow Reserve using intravenous infusion

**CID 3627      Measurement Type**

**Context ID 3627**  
**Measurement Type**  
**Type: Extensible      Version: 20060613**

<b>Coding Scheme Designator</b>	<b>Code Value</b>	<b>Code Meaning</b>
SRT	R-002E1	Best value
SRT	R-00317	Mean
SRT	R-00319	Median
SRT	R-0032E	Mode
SRT	R-00355	Point source measurement
SRT	R-00353	Peak to peak
SRT	R-41D27	Visual estimation
SRT	R-10260	Estimated
SRT	R-41D2D	Calculated
SRT	R-41D41	Measured

**CID 3628      Cardiac Output Methods**

**Context ID 3628**  
**Cardiac Output Methods**  
**Type: Extensible      Version: 20030327**

<b>Coding Scheme Designator</b>	<b>Code Value</b>	<b>Code Meaning</b>
SRT	R-002E5	Thermal Bath
SRT	R-002E7	Thermal Inline
SRT	R-002E6	Dye Dilution

**CID 3629 Procedure Intent**

**Context ID 3629**  
**Procedure Intent**  
Type: Extensible Version: 20030327

Coding Scheme Designator	Code Value	Code Meaning
SRT	R-408C3	Diagnostic Intent
SRT	R-41531	Therapeutic Intent
SRT	R-002E9	Combined Diagnostic and Therapeutic Procedure

**CID 3630 Cardiovascular Anatomic Locations**

**Context ID 3630**  
**Cardiovascular Anatomic Locations**  
Type: Extensible Version: 20030327

Coding Scheme Designator	Code Value	Code Meaning
		INCLUDE CID 3606 Arterial Source Locations
		INCLUDE CID 3607 Venous Source Locations
		INCLUDE CID 3608 Atrial Source Locations
		INCLUDE CID 3609 Ventricular Source Locations
		INCLUDE CID 3610 Gradient Source Locations

**CID 3640 Hypertension**

**Context ID 3640**  
**Hypertension**  
Type: Extensible Version: 20040920

Coding Scheme Designator	Code Value	Code Meaning
SRT	D3-40300	Pulmonary hypertension
SRT	D3-02000	Systemic arterial hypertension

**CID 3641 Hemodynamic Assessments**

**Context ID 3641**  
**Hemodynamic Assessments**  
Type: Extensible Version: 20040920

Coding Scheme Designator	Code Value	Code Meaning
SRT	F-03E0D	Left Ventricular Systolic Pressure
SRT	F-03E0E	Left Ventricular End-Diastolic Pressure

SRT	F-0212C	Pulmonary Artery Pressure
SRT	F-03E86	Pulmonary Vascular Resistance
SRT	F-31146	Pulmonary Capillary Wedge Pressure
SRT	F-03DFE	Right Ventricular Systolic Pressure
SRT	F-03E02	Right Ventricular End-Diastolic Pressure
SRT	F-03DE9	Right Atrial Pressure
SRT	F-39790	Vascular Resistance
SRT	F-31120	Diastolic Pressure

**CID 3642 Degree Findings**

**Context ID 3642  
Degree Findings**

**Type: Extensible Version: 20040920**

<b>Coding Scheme Designator</b>	<b>Code Value</b>	<b>Code Meaning</b>
SRT	G-A316	Decreased
SRT	G-A373	Elevated
SRT	G-A37A	Severely Elevated
SRT	R-40765	Normal Range

**CID 3651 Hemodynamic Measurement Phase**

This context group is a subset of CID 3250.

**Context ID 3651  
Hemodynamic Measurement Phase**

**Type: Extensible Version: 20030327**

<b>Coding Scheme Designator</b>	<b>Code Value</b>	<b>Code Meaning</b>
SRT	G-7293	Cardiac catheterization baseline phase
SRT	G-729B	Cardiac catheterization post contrast phase
SRT	G-7298	Cardiac catheterization post-intervention phase
SRT	G-929D	Cardiac catheterization test/challenging phase
SRT	R-002E3	Cardiac catheterization gradient assessment phase
SRT	P2-71317	Drug Infusion Challenge
SRT	P2-71310	Exercise challenge
SRT	F-01604	Resting State

**CID 3663      Body Surface Area Equations**

**Context ID 3663**  
**Body Surface Area Equations**  
**Type: Extensible                      Version: 20030327**

<b>Coding Scheme Designator</b>	<b>Code Value</b>	<b>Code Meaning</b>
DCM	122240	$BSA = 0.003207 * WT^{(0.7285 - 0.0188 \log(WT))} * HT^{0.3}$
DCM	122241	$BSA = 0.007184 * WT^{0.425} * HT^{0.725}$
DCM	122242	$BSA = 0.0235 * WT^{0.51456} * HT_{cm}^{0.42246}$
DCM	122243	$BSA = 0.024265 * WT^{0.5378} * HT_{cm}^{0.3964}$
DCM	122244	$BSA = (HT * WT/36)^{0.5}$

**CID 3664      Oxygen Consumption Equations and Tables**

**Context ID 3664**  
**Oxygen Consumption Equations and Tables**  
**Type: Extensible                      Version: 20030327**

<b>Coding Scheme Designator</b>	<b>Code Value</b>	<b>Code Meaning</b>
DCM	122247	$VO2_{male} = BSA (138.1 - 11.49 * \log_e(\text{age}) + 0.378 * HR_f)$
DCM	122248	$VO2_{female} = BSA (138.1 - 17.04 * \log_e(\text{age}) + 0.378 * HR_f)$
DCM	122249	$VO2 = V_{eSTPD} * 10 * (FIO_2 - FE_{O_2})$
DCM	122250	$VO2 = 152 * BSA$
DCM	122251	$VO2 = 175 * BSA$
DCM	122252	$VO2 = 176 * BSA$
DCM	122253	Robertson & Reid table
DCM	122254	Fleisch table
DCM	122255	Boothby table

**CID 3666      P50 Equations**

**Context ID 3666**  
**P50 Equations**  
**Type: Extensible                      Version: 20030327**

<b>Coding Scheme Designator</b>	<b>Code Value</b>	<b>Code Meaning</b>
DCM	122256	if (prem age < 3days) P50= 19.9
DCM	122257	if (age < 1day) P50= 21.6
DCM	122258	if (age < 30day) P50= 24.6
DCM	122259	if (age < 18y) P50= 27.2

DCM	122260	if (age < 40y) P50= 27.4
DCM	122261	if (age > 60y) P50= 29.3

**CID 3667 Framingham Scores**

**Context ID 3667**  
**Framingham Scores**  
Type: Extensible Version: 20030327

Coding Scheme Designator	Code Value	Code Meaning
DCM	122230	10 Year CHD Risk
DCM	122231	Comparative Average 10 Year CHD Risk
DCM	122232	Comparative Low 10 Year CHD Risk

**CID 3668 Framingham Tables**

**Context ID 3668**  
**Framingham Tables**  
Type: Extensible Version: 20030327

Coding Scheme Designator	Code Value	Code Meaning
DCM	122233	LDL Cholesterol Score Sheet for Men
DCM	122234	LDL Cholesterol Score Sheet for Women
DCM	122235	Total Cholesterol Score Sheet for Men
DCM	122236	Total Cholesterol Score Sheet for Women

**CID 3670 ECG Procedure Types**

**Context ID 3670**  
**ECG Procedure Types**  
Type: Extensible Version: 20030327

Coding Scheme Designator	Code Value	Code Meaning
SRT	P2-3120A	12-Lead ECG
DCM	122062	15-Lead ECG

**CID 3671 Reason for ECG Exam**

**Context ID 3671  
Reason for ECG Exam**

**Type: Extensible Version: 20030327**

<b>Coding Scheme Designator</b>	<b>Code Value</b>	<b>Code Meaning</b>
SRT	R-00300	Emergency
SRT	P1-00410	Pre-Surgery
SRT	R-00348	Outpatient
SRT	R-0035A	Cardiac Care Unit
SRT	P2-10700	Emergency Department
SRT	R-00302	Murmur
SRT	R-0036E	Routine

**CID 3672 Pacemakers**

**Context ID 3672  
Pacemakers**

**Type: Extensible Version: 20030327**

<b>Coding Scheme Designator</b>	<b>Coding Scheme Version</b>	<b>Code Value</b>	<b>Code Meaning</b>
SCPECG	1.3	D.3.2.6-PAVVI	VVI pacemaker
SCPECG	1.3	D.3.2.6-PAAAI	AAI pacemaker
SCPECG	1.3	D.3.2.6-PAVAT	VAT pacemaker
SCPECG	1.3	D.3.2.6-PAVDD	VDD pacemaker
SCPECG	1.3	D.3.2.6-PADVI	DVI pacemaker
SCPECG	1.3	D.3.2.6-PADDD	DDD pacemaker

**CID 3673 Diagnosis**

**Context ID 3673  
Diagnosis**

**Type: Extensible Version: 20030327**

<b>Coding Scheme Designator</b>	<b>Coding Scheme Version</b>	<b>Code Value</b>	<b>Code Meaning</b>
SCPECG	1.3	5.4.5-32-1	Apparently healthy
SCPECG	1.3	5.4.5-32-10	Acute myocardial infarction
SCPECG	1.3	5.4.5-32-11	Myocardial infarction

SCPECG	1.3	5.4.5-32-12	Previous myocardial infarction
SCPECG	1.3	5.4.5-32-15	Ischemic heart disease
SCPECG	1.3	5.4.5-32-18	Peripheral vascular disease
SCPECG	1.3	5.4.5-32-20	Cyanotic congenital heart disease
SCPECG	1.3	5.4.5-32-21	Acyanotic congenital heart disease
SCPECG	1.3	5.4.5-32-22	Valvular heart disease
SCPECG	1.3	5.4.5-32-25	Hypertension
SCPECG	1.3	5.4.5-32-27	Cerebrovascular accident
SCPECG	1.3	5.4.5-32-30	Cardiomyopathy
SCPECG	1.3	5.4.5-32-35	Pericarditis
SCPECG	1.3	5.4.5-32-36	Myocarditis
SCPECG	1.3	5.4.5-32-40	Post-operative cardiac surgery
SCPECG	1.3	5.4.5-32-42	Implanted cardiac pacemaker
SCPECG	1.3	5.4.5-32-45	Pulmonary embolism
SCPECG	1.3	5.4.5-32-50	Respiratory disease
SCPECG	1.3	5.4.5-32-55	Endocrine disease
SCPECG	1.3	5.4.5-32-60	Neurological disease
SCPECG	1.3	5.4.5-32-65	Alimentary disease
SCPECG	1.3	5.4.5-32-70	Renal Disease
SCPECG	1.3	5.4.5-32-80	Pre-operative general surgery
SCPECG	1.3	5.4.5-32-81	Post-operative general surgery
SCPECG	1.3	5.4.5-32-90	General medical
SCPECG	1.3	5.4.5-32-100	Other

**CID 3675      Other Filters**

**Context ID 3675  
Other Filters**

**Type: Extensible      Version: 20030327**

<b>Coding Scheme Designator</b>	<b>Coding Scheme Version</b>	<b>Code Value</b>	<b>Code Meaning</b>
SCPECG	1.3	5.4.5-29-0	60 Hertz notch filter
SCPECG	1.3	5.4.5-29-1	50 Hertz notch filter
SCPECG	1.3	5.4.5-29-2	Artifact filter
SCPECG	1.3	5.4.5-29-3	Baseline filter

**CID 3676      Lead Measurement Technique**

**Context ID 3676  
Lead Measurement Technique**

- Standard -



Type: Extensible

Version: 20030327

Coding Scheme Designator	Code Value	Code Meaning
SRT	R-002DA	Averaged
SRT	R-0036D	Routine
SRT	R-00319	Median
SRT	R-0036A	Representative
SRT	R-00373	Single Beats

**CID 3677 Summary Codes ECG**

**Context ID 3677  
Summary Codes ECG**

Type: Extensible

Version: 20030327

Coding Scheme Designator	Coding Scheme Version	Code Value	Code Meaning
SCPECG	1.3	D.3.2-NORM	Normal ECG
SCPECG	1.3	D.3.2-ABECG	Abnormal ECG
SCPECG	1.3	D.3.2-BOECG	Borderline Normal ECG

**CID 3678 QT Correction Algorithms**

**Context ID 3678  
QT Correction Algorithms**

Type: Extensible

Version: 20030327

Coding Scheme Designator	Coding Scheme Version	Code Value	Code Meaning
SCPECG	1.3	5.10.2.5-7-1	Bazett QT Correction Algorithm
SCPECG	1.3	5.10.2.5-7-2	Hodges QT Correction Algorithm
SCPECG	1.3	5.10.2.5-7-3	Other QT Correction Algorithm

**CID 3679 ECG Morphology Descriptions**

**Context ID 3679  
ECG Morphology Descriptions**

Type: Extensible

Version: 20030327

Coding Scheme Designator	Coding Scheme Version	Code Value	Code Meaning
SCPECG	1.3	5.13.5.1-0	Unknown

SCPECG	1.3	5.13.5.1-1	Positive
SCPECG	1.3	5.13.5.1-2	Negative
SCPECG	1.3	5.13.5.1-3	positive/negative
SCPECG	1.3	5.13.5.1-4	negative/positive
SCPECG	1.3	5.13.5.1-5	positive/negative/positive
SCPECG	1.3	5.13.5.1-6	negative/positive/negative
SCPECG	1.3	5.13.5.1-7	notched M-shaped
SCPECG	1.3	5.13.5.1-8	notched W-shaped

**CID 3680 ECG Lead Noise Descriptions**

**Context ID 3680**  
**ECG Lead Noise Descriptions**  
Type: Extensible Version: 20030327

Coding Scheme Designator	Coding Scheme Version	Code Value	Code Meaning
SCPECG	1.3	5.13.5.2-0	AC (mains) noise
SCPECG	1.3	5.13.5.2-2	overrange
SCPECG	1.3	5.13.5.2-4	wander
SCPECG	1.3	5.13.5.2-6	tremor or muscle artifact
SCPECG	1.3	5.13.5.2-8	spikes or sudden jumps
SCPECG	1.3	5.13.5.2-10	electrode loose or off
SCPECG	1.3	5.13.5.2-12	pacemaker
SCPECG	1.3	5.13.5.2-14	interchanged lead

**CID 3681 ECG Lead Noise Modifiers**

**Context ID 3681**  
**ECG Lead Noise Modifiers**  
Type: Extensible Version: 20030327

Coding Scheme Designator	Coding Scheme Version	Code Value	Code Meaning
SCPECG	1.3	5-13-5-2-0	None
SCPECG	1.3	5-13-5-2-1	Moderate
SCPECG	1.3	5-13-5-2-2	Severe
SCPECG	1.3	5-13-5-2-3	Unknown

**CID 3682      Probability**

**Context ID 3682  
Probability**

**Type: Extensible      Version: 20030327**

<b>Coding Scheme Designator</b>	<b>Coding Scheme Version</b>	<b>Code Value</b>	<b>Code Meaning</b>
SCPECG	1.3	D.2.2-DE	definite
SCPECG	1.3	D.2.2-PR	probable
SCPECG	1.3	D.2.2-PS	possible
SCPECG	1.3	D.2.2-CE	rule out/cannot exclude
SCPECG	1.3	D.2.2-CO	consider
SCPECG	1.3	D.2.2-SS	strongly suggestive
SCPECG	1.3	D.2.2-CW	consistent with
SCPECG	1.3	D.2.2-UN	unknown

**CID 3683      Modifiers**

**Context ID 3683  
Modifiers**

**Type: Extensible      Version: 20030327**

<b>Coding Scheme Designator</b>	<b>Coding Scheme Version</b>	<b>Code Value</b>	<b>Code Meaning</b>
SCPECG	1.3	D.2.3-AB	abnormal
SCPECG	1.3	D.2.3-AC	acute
SCPECG	1.3	D.2.3-AF	antero-inferior
SCPECG	1.3	D.2.3-AI	age indeterminate
SCPECG	1.3	D.2.3-AL	anterolateral
SCPECG	1.3	D.2.3-AN	anterior
SCPECG	1.3	D.2.3-AS	anteroseptal
SCPECG	1.3	D.2.3-AT	atrial
SCPECG	1.3	D.2.3-AU	age undetermined
SCPECG	1.3	D.2.3-BA	basal
SCPECG	1.3	D.2.3-BA	borderline abnormal
SCPECG	1.3	D.2.3-BN	borderline normal
SCPECG	1.3	D.2.3-BO	borderline
SCPECG	1.3	D.2.3-CP	complete
SCPECG	1.3	D.2.3-DI	diffuse
SCPECG	1.3	D.2.3-EL	compatible with electrolyte abnormalities
SCPECG	1.3	D.2.3-EV	evolving

SCPECG	1.3	D.2.3-EX	extensive
SCPECG	1.3	D.2.3-HL	high lateral
SCPECG	1.3	D.2.3-IC	incomplete
SCPECG	1.3	D.2.3-IL	inferolateral
SCPECG	1.3	D.2.3-IN	inferior
SCPECG	1.3	D.2.3-IP	inferoposterior
SCPECG	1.3	D.2.3-LA	lateral
SCPECG	1.3	D.2.3-LV	compatible with left ventricular strain
SCPECG	1.3	D.2.3-MA	major
SCPECG	1.3	D.2.3-MD	compatible with myocardial ischemic damage
SCPECG	1.3	D.2.3-MI	minor
SCPECG	1.3	D.2.3-MO	moderate
SCPECG	1.3	D.2.3-ND	nodal
SCPECG	1.3	D.2.3-NO	within normal limits
SCPECG	1.3	D.2.3-NX	may be normal variant
SCPECG	1.3	D.2.3-OL	old
SCPECG	1.3	D.2.3-PE	compatible with pericarditis
SCPECG	1.3	D.2.3-PL	posterolateral
SCPECG	1.3	D.2.3-PO	posterior
SCPECG	1.3	D.2.3-RE	recent
SCPECG	1.3	D.2.3-SE	septal
SCPECG	1.3	D.2.3-SI	sinus
SCPECG	1.3	D.2.3-SN	subendocardial
SCPECG	1.3	D.2.3-SP	subepicardial
SCPECG	1.3	D.2.3-SU	subacute
SCPECG	1.3	D.2.3-SV	supraventricular
SCPECG	1.3	D.2.3-TY	typical
SCPECG	1.3	D.2.3-VE	ventricular
SCPECG	1.3	D.2.3-WI	widespread
SCPECG	1.3	D.2.3-XA	probably acute (recent)
SCPECG	1.3	D.2.3-XO	probably old
SCPECG	1.3	D.2.3-YA	possibly acute (recent)
SCPECG	1.3	D.2.3-YO	possibly old
SCPECG	1.3	D.2.3-YT	atypical

**CID 3684**      **Trend**

**Context ID 3684**  
**Trend**

**Type: Extensible**

**Version: 20030327**

Coding Scheme Designator	Coding Scheme Version	Code Value	Code Meaning
SCPECG	1.3	D.2.3-4-SE	serial changes consistent with...
SCPECG	1.3	D.2.3-4-CC	continuing changes of...
SCPECG	1.3	D.2.3-4-OC	occasional
SCPECG	1.3	D.2.3-4-IM	intermittent
SCPECG	1.3	D.2.3-4-TE	temporary
SCPECG	1.3	D.2.3-4-EV	evolving
SCPECG	1.3	D.2.3-4-NE	new
SCPECG	1.3	D.2.3-4-MU	multiple
SCPECG	1.3	D.2.3-4-TR	transient
SCPECG	1.3	D.2.3-4-UF	unifocal
SCPECG	1.3	D.2.3-4-MF	multifocal
SCPECG	1.3	D.2.3-4-FR	frequent

**CID 3685      Conjunctive Terms**

**Context ID 3685  
Conjunctive Terms**

**Type: Extensible      Version: 20030327**

Coding Scheme Designator	Coding Scheme Version	Code Value	Code Meaning
SCPECG	1.3	D.2.5-1-AND	and
SCPECG	1.3	D.2.5-1-OR	or
SCPECG	1.3	D.2.5-1-NOT	not
SCPECG	1.3	D.2.5-1-XOR	exclusive or
SCPECG	1.3	D.2.5-3-SER	serial changes of
SCPECG	1.3	D.2.5-3-DEC	decreased in comparison to previous ECG
SCPECG	1.3	D.2.5-3-INC	increased in comparison to previous ECG
SCPECG	1.3	D.2.5-3-UNC	unchanged in comparison to previous ECG
SCPECG	1.3	D.2.5-3-CHG	changed in comparison to previous ECG
SCPECG	1.3	D.2.5-3-DIS	disappeared in comparison to previous ECG
SCPECG	1.3	D.2.5-3-REP	replaced statement reported previously
SCPECG	1.3	D.2.5-3-IMP	improved (compared to)
SCPECG	1.3	D.2.5-3-WRS	worse (compared to)
SCPECG	1.3	D.2.5-4-RES	results in, or causes
SCPECG	1.3	D.2.5-4-SEC	is secondary to
SCPECG	1.3	D.2.5-4-ASS	is associated with
SCPECG	1.3	D.2.5-4-EXC	exclude, rule out, or consider also
SCPECG	1.3	D.2.5-4-WTH	with

SCPECG	1.3	D.2.5-4-ALT	alternating with
--------	-----	-------------	------------------

**CID 3686 ECG Interpretive Statements**

**Context ID 3686**  
**ECG Interpretive Statements**  
Type: Extensible      Version: 20030327

Coding Scheme Designator	Coding Scheme Version	Code Value	Code Meaning
SCPECG	1.3	D.3-SVPCS	(multiple) supraventricular premature complexes
SCPECG	1.3	D.3-B2T1	(predominant) 2:1 block
SCPECG	1.3	D.3-C2T1	(predominant) 2:1 conduction
SCPECG	1.3	D.3-B351	(predominant) 3:1 block
SCPECG	1.3	D.3-C3T1	(predominant) 3:1 conduction
SCPECG	1.3	D.3-B4T1	(predominant) 4:1 block
SCPECG	1.3	D.3-C4T1	(predominant) 4:1 conduction
SCPECG	1.3	D.3-B5T1	(predominant) 5:1 block
SCPECG	1.3	D.3-C5T1	(predominant) 5:1 conduction
SCPECG	1.3	D.3-PAAAI	AAI pacemaker
SCPECG	1.3	D.3-ABSVC	aberrant complex, possibly supraventricular origin
SCPECG	1.3	D.3-ABSVS	aberrant complexes, possibly supraventricular origin
SCPECG	1.3	D.3-ABBCO	aberrant conduction
SCPECG	1.3	D.3-ABPCS	aberrant premature complexes, origin unknown
SCPECG	1.3	D.3-ABASH	aberrant supraventricular complexes, Ashman type
SCPECG	1.3	D.3-ABER	aberrantly conducted complex(es)
SCPECG	1.3	D.3-ABECG	abnormal ECG
SCPECG	1.3	D.3-ABFA	abnormal for age
SCPECG	1.3	D.3-ABFB	abnormal for build
SCPECG	1.3	D.3-ABPAX	abnormal P-axis
SCPECG	1.3	D.3-ABQRS	abnormal QRS
SCPECG	1.3	D.3-ABRPR	abnormal R-wave progression
SCPECG	1.3	D.3-ABSTT	abnormal ST-T
SCPECG	1.3	D.3-ACAR	accelerated atrial rhythm
SCPECG	1.3	D.3-AAVCO	accelerated AV conduction
SCPECG	1.3	D.3-ACJR	accelerated junctional rhythm
SCPECG	1.3	D.3-ACVR	accelerated ventricular rhythm
SCPECG	1.3	D.3-AHERR	acquisition/hardware error
SCPECG	1.3	D.3-DSCAL	all leads double standard calibration (i.e. 20 mm/mV)

SCPECG	1.3	D.3-HSCAL	all leads half standard calibration (i.e. 5 mm/mV)
SCPECG	1.3	D.3-A2AVB	alternating second degree AV block
SCPECG	1.3	D.3-AMI	anterior myocardial infarction
SCPECG	1.3	D.3-ANTCO	anterograde conduction
SCPECG	1.3	D.3-ALMI	anterolateral myocardial infarction
SCPECG	1.3	D.3-ASMI	anteroseptal myocardial infarction
SCPECG	1.3	D.3-APMI	apical myocardial infarction
SCPECG	1.3	D.3-ARRHY	arrhythmia, origin unknown
SCPECG	1.3	D.3-ARTEF	artifacts
SCPECG	1.3	D.3-PACEA	artificial pacemaker rhythm with 100% capture
SCPECG	1.3	D.3-PACEP	artificial pacemaker rhythm with partial capture
SCPECG	1.3	D.3-PACEF	artificial pacemaker rhythm with underlying atrial fibrillation
SCPECG	1.3	D.3-ASYST	asystole
SCPECG	1.3	D.3-ABIG	atrial bigeminy
SCPECG	1.3	D.3-AEC	atrial escape complex(es)
SCPECG	1.3	D.3-AFIB	atrial fibrillation
SCPECG	1.3	D.3-AFLT	atrial flutter
SCPECG	1.3	D.3-APARA	atrial parasystole
SCPECG	1.3	D.3-APC	atrial premature complex
SCPECG	1.3	D.3-PAC	atrial premature complex
SCPECG	1.3	D.3-ARATE	atrial rate
SCPECG	1.3	D.3-ARHYT	atrial rhythm
SCPECG	1.3	D.3-ATACH	atrial tachycardia
SCPECG	1.3	D.3-ATRIG	atrial trigeminy
SCPECG	1.3	D.3-AVNRT	atrioventricular nodal re-entrant tachycardia
SCPECG	1.3	D.3-AVRT	atrioventricular reciprocating tachycardia
SCPECG	1.3	D.3-ALBBB	atypical left bundle branch block
SCPECG	1.3	D.3-AVREN	AV nodal re-entry
SCPECG	1.3	D.3-AVDIS	AV-dissociation
SCPECG	1.3	D.3-AVJR	AV-junctional rhythm
SCPECG	1.3	D.3-AXPOS	axis shifted posteriorly
SCPECG	1.3	D.3-AXSUP	axis shifted superiorly
SCPECG	1.3	D.3-AXVER	axis vertical in frontal plane
SCPECG	1.3	D.3-WANDR	baseline wander
SCPECG	1.3	D.3-BAE	bi-atrial enlargement
SCPECG	1.3	D.3-BAO	bi-atrial overload
SCPECG	1.3	D.3-BIFAS	bifascicular block
SCPECG	1.3	D.3-BIGU	bigeminal pattern
SCPECG	1.3	D.3-EPARV	bipolar electronic pacemaker at the apex of the right ventricle
SCPECG	1.3	D.3-BVH	biventricular hypertrophy

SCPECG	1.3	D.3-BOECG	borderline ECG
SCPECG	1.3	D.3-BPAC	BPAC blocked premature atrial contraction
SCPECG	1.3	D.3-BRADO	bradycardia, origin unknown or not specified
SCPECG	1.3	D.3-CAPT	capture complex(es)
SCPECG	1.3	D.3-ASD	changes compatible with atrial septal defect (ostium secundum)
SCPECG	1.3	D.3-CWRT	clockwise rotation
SCPECG	1.3	D.3-ECD	compatible endocardial cushion defect (ASD ostium primum)
SCPECG	1.3	D.3-ACA	compatible with anomalous location of the coronary
SCPECG	1.3	D.3-MYOPA	compatible with cardiomyopathy
SCPECG	1.3	D.3-EBSTA	compatible with Ebstein's anomaly
SCPECG	1.3	D.3-NDOC	compatible with endocrine disease
SCPECG	1.3	D.3-IBP	compatible with hypertension
SCPECG	1.3	D.3-ISDIG	compatible with ischemia / digitalis effect
SCPECG	1.3	D.3-MYOCA	compatible with myocarditis
SCPECG	1.3	D.3-PULM	compatible with pulmonary embolism
SCPECG	1.3	D.3-TCA	compatible with tricuspid atresia
SCPECG	1.3	D.3-CLBBB	complete left bundle branch block
SCPECG	1.3	D.3-CRBBB	complete right bundle branch block
SCPECG	1.3	D.3-CONCO	concealed conduction
SCPECG	1.3	D.3-CONRE	concealed re-entry
SCPECG	1.3	D.3-HPRCA	consider hypercalcemia
SCPECG	1.3	D.3-HPRK	consider hyperkalemia
SCPECG	1.3	D.3-HPOCA	consider hypocalcemia
SCPECG	1.3	D.3-HPOK	consider hypokalemia
SCPECG	1.3	D.3-COPD	consistent with chronic obstructive pulmonary disease
SCPECG	1.3	D.3-CCWRT	counterclockwise rotation
SCPECG	1.3	D.3-CRIMA	criteria for
SCPECG	1.3	D.3-PADDD	DDD pacemaker
SCPECG	1.3	D.3-PACED	demand pacemaker rhythm
SCPECG	1.3	D.3-PADEM	demand pacing, based upon intrinsic complexes
SCPECG	1.3	D.3-DXTRO	dextrocardia
SCPECG	1.3	D.3-DIG	digitalis-effect
SCPECG	1.3	D.3-PAD	dual chamber electronic pacing
SCPECG	1.3	D.3-PADVI	DVI pacemaker
SCPECG	1.3	D.3-WHNOR	ECG within normal limits for age and sex
SCPECG	1.3	D.3-EAR	ectopic atrial rhythm
SCPECG	1.3	D.3-PAA	electronic atrial pacing
SCPECG	1.3	D.3-EPAVS	electronic pacemaker AV sequential, normal



			capture
SCPECG	1.3	D.3-EPDM	electronic pacemaker, demand mode
SCPECG	1.3	D.3-EPFC	electronic pacemaker, failure to capture
SCPECG	1.3	D.3-EPFS	electronic pacemaker, failure to sense
SCPECG	1.3	D.3-EPVC	electronic pacemaker, ventricular capture
SCPECG	1.3	D.3-PAVA	electronic ventricular pacing with atrial sensing
SCPECG	1.3	D.3-ENTBL	entrance block
SCPECG	1.3	D.3-EPI	epicardial injury
SCPECG	1.3	D.3-ESCUN	escape complex, origin unknown
SCPECG	1.3	D.3-EXIBL	exit block
SCPECG	1.3	D.3-EBRAD	extreme bradycardia
SCPECG	1.3	D.3-ETACH	extreme tachycardia
SCPECG	1.3	D.3-FAULT	faulty lead
SCPECG	1.3	D.3-1AVB	first degree AV block
SCPECG	1.3	D.3-FCOUP	fixed coupling interval
SCPECG	1.3	D.3-FUSC	fusion complex(es)
SCPECG	1.3	D.3-HIGHT	high amplitude T-waves
SCPECG	1.3	D.3-HPVOL	high P-voltages
SCPECG	1.3	D.3-HVOLT	high QRS voltage
SCPECG	1.3	D.3-HVOLH	high QRS voltage in the horizontal leads
SCPECG	1.3	D.3-HVOLF	high QRS voltages in the frontal leads
SCPECG	1.3	D.3-HTVOL	high T-voltages
SCPECG	1.3	D.3-HLMI	high-lateral myocardial infarction
SCPECG	1.3	D.3-AXHOR	horizontal axis in frontal plane
SCPECG	1.3	D.3-IDIOR	idioventricular rhythm
SCPECG	1.3	D.3-ILBBB	incomplete left bundle branch block
SCPECG	1.3	D.3-INCAN	incomplete or no analysis (by the program)
SCPECG	1.3	D.3-IRBBB	incomplete right bundle branch block
SCPECG	1.3	D.3-PINFO	inconsistent or erroneous patient demographic data
SCPECG	1.3	D.3-IMI	inferior myocardial infarction
SCPECG	1.3	D.3-ILMI	inferolateral myocardial infarction
SCPECG	1.3	D.3-IPMI	inferoposterior myocardial infarction
SCPECG	1.3	D.3-IPLMI	inferoposterolateral myocardial infarction
SCPECG	1.3	D.3-SIMUL	input is from simulator or test pattern
SCPECG	1.3	D.3-I2AVB	intermittent second degree AV block
SCPECG	1.3	D.3-CLIN	interpret with clinical data
SCPECG	1.3	D.3-IACD	intra-atrial conduction delay
SCPECG	1.3	D.3-IVCD>	intraventricular conduction disturbance (QRS>120 ms)
SCPECG	1.3	D.3-INVT	inverted T-waves
SCPECG	1.3	D.3-IRREG	irregular rhythm

SCPECG	1.3	D.3-IVR	irregular ventricular response
SCPECG	1.3	D.3-ISC	Ischemic
SCPECG	1.3	D.3-JBRAD	junctional bradycardia
SCPECG	1.3	D.3-JEC	junctional escape complex(es)
SCPECG	1.3	D.3-JESCR	junctional escape rhythm
SCPECG	1.3	D.3-JPC	junctional premature complex(es)
SCPECG	1.3	D.3-JRHYT	junctional rhythm
SCPECG	1.3	D.3-STDJ	junctional ST depression
SCPECG	1.3	D.3-JTACH	junctional tachycardia
SCPECG	1.3	D.3-JUV	juvenile T waves
SCPECG	1.3	D.3-LMI	lateral myocardial infarction
SCPECG	1.3	D.3-LMISP	lead misplacement
SCPECG	1.3	D.3-LAFB	left anterior fascicular block
SCPECG	1.3	D.3-LAE	left atrial enlargement
SCPECG	1.3	D.3-LAO	left atrial overload
SCPECG	1.3	D.3-LAR	left atrial rhythm
SCPECG	1.3	D.3-LAD	left axis deviation of QRS in frontal plane (< -30)
SCPECG	1.3	D.3-LPFB	left posterior fascicular block
SCPECG	1.3	D.3-LVH	left ventricular hypertrophy
SCPECG	1.3	D.3-AXL	leftward axis
SCPECG	1.3	D.3-DSLIM	limb leads double standard calibration
SCPECG	1.3	D.3-HSLIM	limb leads half standard calibration
SCPECG	1.3	D.3-LNGQT	long QT-interval
SCPECG	1.3	D.3-LRR	long R-R interval measured
SCPECG	1.3	D.3-LOWT	low amplitude T-waves
SCPECG	1.3	D.3-LVOLT	low QRS voltages in the frontal and horizontal leads
SCPECG	1.3	D.3-LVOLH	low QRS voltages in the horizontal leads
SCPECG	1.3	D.3-RAR	low right atrial rhythm
SCPECG	1.3	D.3-LVOLF	low voltage in frontal leads
SCPECG	1.3	D.3-LGL	Lown-Ganong-Levine syndrome
SCPECG	1.3	D.3-PACEM	malfunctioning artificial pacemaker
SCPECG	1.3	D.3-MAPCS	MAPCS multiple atrial premature complexes
SCPECG	1.3	D.3-MSAR	marked sinus arrhythmia
SCPECG	1.3	D.3-CRIMI	minimal criteria for
SCPECG	1.3	D.3-IVCD<	minor intraventricular conduction disturbance (QRS<120ms)
SCPECG	1.3	D.3-NODAT	missing or no data
SCPECG	1.3	D.3-MOBI2	Mobitz type 2 second degree AV block
SCPECG	1.3	D.3-CRIMO	moderate criteria for
SCPECG	1.3	D.3-MAR	multifocal atrial rhythm
SCPECG	1.3	D.3-MFAT	multifocal atrial tachycardia

SCPECG	1.3	D.3-MTACH	multifocal tachycardia
SCPECG	1.3	D.3-MICS	multiple interpolated complexes
SCPECG	1.3	D.3-MJPCS	multiple junctional premature complexes
SCPECG	1.3	D.3-MVPCS	multiple premature ventricular complexes
SCPECG	1.3	D.3-MVICS	multiple ventricular interpolated complexes
SCPECG	1.3	D.3-MI	myocardial infarction
SCPECG	1.3	D.3-NQTAC	narrow QRS tachycardia
SCPECG	1.3	D.3-NODRH	nodal rhythm
SCPECG	1.3	D.3-NOISE	noisy recording
SCPECG	1.3	D.3-NDT	non-diagnostic T abnormalities
SCPECG	1.3	D.3-IVCD	non-specific intraventricular conduction disturban
SCPECG	1.3	D.3-NSPEP	non-specific P wave abnormalities
SCPECG	1.3	D.3-NST	non-specific ST changes
SCPECG	1.3	D.3-STD	non-specific ST depression
SCPECG	1.3	D.3-STE	non-specific ST elevation
SCPECG	1.3	D.3-NT	non-specific T-wave changes
SCPECG	1.3	D.3-NSCAL	non-standard calibration
SCPECG	1.3	D.3-NSVT	non-sustained ventricular tachycardia
SCPECG	1.3	D.3-NORM	normal ECG
SCPECG	1.3	D.3-NFA	normal for age
SCPECG	1.3	D.3-NFB	normal for build
SCPECG	1.3	D.3-PACE	normal functioning artificial pacemaker
SCPECG	1.3	D.3-NLP	normal P wave
SCPECG	1.3	D.3-NLQRS	normal QRS
SCPECG	1.3	D.3-NSR	normal sinus rhythm
SCPECG	1.3	D.3-NLSTT	normal ST-T
SCPECG	1.3	D.3-TNOR	normal T-wave variations
SCPECG	1.3	D.3-STNOR	normal variant
SCPECG	1.3	D.3-OCAP	occasional capture
SCPECG	1.3	D.3-ONPAC	occasional non-paced complexes
SCPECG	1.3	D.3-OVPAC	occasional ventricular paced complexes
SCPECG	1.3	D.3-ORTCO	orthograde conduction
SCPECG	1.3	D.3-PAPCS	paired atrial premature complexes
SCPECG	1.3	D.3-PJPCS	paired junctional premature complexes
SCPECG	1.3	D.3-PPVCS	paired ventricular premature complexes
SCPECG	1.3	D.3-PVPCS	paired ventricular premature complexes
SCPECG	1.3	D.3-PAT	paroxysmal atrial tachycardia
SCPECG	1.3	D.3-PSVT	paroxysmal supraventricular tachycardia
SCPECG	1.3	D.3-PED	pediatric interpretation
SCPECG	1.3	D.3-QCERR	poor data quality, interpretation may be adversely affected

SCPECG	1.3	D.3-POORR	poor R-wave progression in precordial leads
SCPECG	1.3	D.3-POSAB	possibly abnormal ECG
SCPECG	1.3	D.3-METAB	possibly due to metabolic changes
SCPECG	1.3	D.3-MEASE	possibly measurement error
SCPECG	1.3	D.3-POSNL	possibly normal ECG
SCPECG	1.3	D.3-PMI	posterior myocardial infarction
SCPECG	1.3	D.3-STPVC	post-extrasystolic T-wave changes
SCPECG	1.3	D.3-POSTO	post-operative changes
SCPECG	1.3	D.3-DSPRE	precordial leads double standard calibration
SCPECG	1.3	D.3-HSPRE	precordial leads half standard calibration
SCPECG	1.3	D.3-PREEX	pre-excitation
SCPECG	1.3	D.3-PRC	premature complex(es)
SCPECG	1.3	D.3-PRANT	prominent anterior forces
SCPECG	1.3	D.3-PROMR	prominent R waves in right precordial leads
SCPECG	1.3	D.3-PE	pulmonary emphysema
SCPECG	1.3	D.3-QWAVE	Q waves present
SCPECG	1.3	D.3-AXIND	QRS axis indeterminate
SCPECG	1.3	D.3-RVR	rapid ventricular response
SCPECG	1.3	D.3-RATE	rate, not specified ventricular or atrial
SCPECG	1.3	D.3-RECIP	reciprocal or re-entrant impulse
SCPECG	1.3	D.3-RST	reciprocal ST-T changes
SCPECG	1.3	D.3-RENTR	re-entry phenomenon
SCPECG	1.3	D.3-REGRH	regular rhythm
SCPECG	1.3	D.3-ACET	related to pacemaker activity
SCPECG	1.3	D.3-RETCO	retrograde conduction
SCPECG	1.3	D.3-AECHO	return of impulse to its chamber of origin: the atrium
SCPECG	1.3	D.3-VECHO	return of impulse to its chamber of origin: the ventricle
SCPECG	1.3	D.3-STPAC	review ST-T analysis for the effects of pacing
SCPECG	1.3	D.3-RHY	rhythm
SCPECG	1.3	D.3-RAE	right atrial enlargement
SCPECG	1.3	D.3-RAO	right atrial overload
SCPECG	1.3	D.3-RAD	right axis deviation of QRS in frontal plane (> +90)
SCPECG	1.3	D.3-RVD	right ventricular dominance
SCPECG	1.3	D.3-RVH	right ventricular hypertrophy
SCPECG	1.3	D.3-AXR	rightward axis
SCPECG	1.3	D.3-RSR1	rSr' type in V1 or V2
SCPECG	1.3	D.3-RAPCS	run of atrial premature complexes
SCPECG	1.3	D.3-RATAC	run of atrial tachycardia
SCPECG	1.3	D.3-RJPCS	run of junctional premature complexes
SCPECG	1.3	D.3-RJTAC	run of junctional tachycardia

SCPECG	1.3	D.3-RPVCS	run of ventricular premature complexes
SCPECG	1.3	D.3-RVPCS	run of ventricular premature complexes
SCPECG	1.3	D.3-RVTAC	run of ventricular tachycardia
SCPECG	1.3	D.3-S1S23	S1 S2 S3 type QRS pattern
SCPECG	1.3	D.3-2AVB	second degree AV block
SCPECG	1.3	D.3-CONG	secondary to congenital heart disease
SCPECG	1.3	D.3-RESP	secondary to respiratory disease
SCPECG	1.3	D.3-VALV	secondary to valvular heart disease
SCPECG	1.3	D.3-SEHYP	septal hypertrophy
SCPECG	1.3	D.3-SHTPR	Short PR-interval.
SCPECG	1.3	D.3-SHTQT	short QT-interval
SCPECG	1.3	D.3-SABLK	sino-atrial block
SCPECG	1.3	D.3-SAR	sinus arrest
SCPECG	1.3	D.3-SARA	sinus arrest with atrial escape
SCPECG	1.3	D.3-SARJ	sinus arrest with junctional escape
SCPECG	1.3	D.3-SARSV	sinus arrest with supraventricular escape
SCPECG	1.3	D.3-SARV	sinus arrest with ventricular escape
SCPECG	1.3	D.3-SARRH	sinus arrhythmia
SCPECG	1.3	D.3-SBRAD	sinus bradycardia
SCPECG	1.3	D.3-SPAUS	sinus pause
SCPECG	1.3	D.3-SR	sinus rhythm
SCPECG	1.3	D.3-STACH	sinus tachycardia
SCPECG	1.3	D.3-SVR	slow ventricular response
SCPECG	1.3	D.3-STVAG	ST-elevation V1-V3 possibly due to enhanced vagal tone
SCPECG	1.3	D.3-STT	ST-T change
SCPECG	1.3	D.3-REPOL	ST-T changes compatible with early repolarization
SCPECG	1.3	D.3-PERIC	ST-T changes compatible with pericarditis
SCPECG	1.3	D.3-ANEUR	ST-T changes compatible with ventricular aneurysm
SCPECG	1.3	D.3-QUIN	ST-T changes due to quinidine-effect
SCPECG	1.3	D.3-INJ	subendocardial injury
SCPECG	1.3	D.3-MYOIN	suggests myocardial infarction, no location specified
SCPECG	1.3	D.3-SVARR	supraventricular arrhythmia
SCPECG	1.3	D.3-SVBIG	supraventricular bigeminy
SCPECG	1.3	D.3-SVBRA	supraventricular bradycardia
SCPECG	1.3	D.3-SVEC	supraventricular escape complex(es)
SCPECG	1.3	D.3-SVIC	supraventricular interpolated complex(es)
SCPECG	1.3	D.3-SVPC	supraventricular premature complex
SCPECG	1.3	D.3-SVRHY	supraventricular rhythm
SCPECG	1.3	D.3-SVTAC	supraventricular tachycardia

SCPECG	1.3	D.3-SVTRI	supraventricular trigeminy
SCPECG	1.3	D.3-ARMRE	suspect arm leads reversed
SCPECG	1.3	D.3-SVT	sustained ventricular tachycardia
SCPECG	1.3	D.3-TACHO	tachycardia, origin unknown or not specified
SCPECG	1.3	D.3-3AVB	third degree AV block
SCPECG	1.3	D.3-TORSA	torsade des pointes ventricular tachycardia
SCPECG	1.3	D.3-TRSLT	transition in horizontal leads shifted leftward
SCPECG	1.3	D.3-TRSRT	transition in horizontal leads shifted rightward
SCPECG	1.3	D.3-TRNZL	Transition zone in precordial leads displaced to left
SCPECG	1.3	D.3-TRNZR	Transition zone in precordial leads displaced to right
SCPECG	1.3	D.3-TRFAS	trifascicular block
SCPECG	1.3	D.3-TRIGU	trigeminal pattern
SCPECG	1.3	D.3-TAB	T-wave abnormality
SCPECG	1.3	D.3-UNRHY	undetermined rhythm
SCPECG	1.3	D.3-EPU	unipolar electronic pacemaker
SCPECG	1.3	D.3-EPURV	unipolar electronic pacemaker at the apex of the right ventricle
SCPECG	1.3	D.3-BBB	unspecified bundle branch block
SCPECG	1.3	D.3-BLOCK	unspecified delay or failure of impulse propagation
SCPECG	1.3	D.3-UFB	unusual for build
SCPECG	1.3	D.3-UNPAX	unusual P-axis
SCPECG	1.3	D.3-VARBL	variable block
SCPECG	1.3	D.3-VARCO	variable conduction
SCPECG	1.3	D.3-VCoup	variable coupling interval
SCPECG	1.3	D.3-PAVAT	VAT pacemaker
SCPECG	1.3	D.3-PAVDD	VDD pacemaker
SCPECG	1.3	D.3-VBIG	ventricular bigeminy
SCPECG	1.3	D.3-VEC	ventricular escape complex(es)
SCPECG	1.3	D.3-VESCR	ventricular escape rhythm
SCPECG	1.3	D.3-VFIB	ventricular fibrillation
SCPECG	1.3	D.3-VFLT	ventricular flutter
SCPECG	1.3	D.3-VIC	ventricular interpolated complexes
SCPECG	1.3	D.3-VPARA	ventricular parasystole
SCPECG	1.3	D.3-VPC	ventricular premature complex
SCPECG	1.3	D.3-PVC	ventricular premature complex
SCPECG	1.3	D.3-VQUAG	ventricular quadrigeminy
SCPECG	1.3	D.3-VRATE	ventricular rate
SCPECG	1.3	D.3-VRHYT	ventricular rhythm
SCPECG	1.3	D.3-VTACH	ventricular tachycardia
SCPECG	1.3	D.3-VTRIG	ventricular trigeminy

SCPECG	1.3	D.3-VABL	ventriculo-atrial block
SCPECG	1.3	D.3-VCLVH	voltage criteria (QRS) for left ventricular hypertrophy
SCPECG	1.3	D.3-VCRVH	voltage criteria (QRS) for right ventricular hypertrophy
SCPECG	1.3	D.3-PAVVI	VVI pacemaker
SCPECG	1.3	D.3-WANDP	wandering pacemaker
SCPECG	1.3	D.3-WENCK	Wenckebach phenomenon
SCPECG	1.3	D.3-WQTAC	wide QRS tachycardia
SCPECG	1.3	D.3-WRV	wide rate variation
SCPECG	1.3	D.3-WPWA	Wolf-Parkinson type A
SCPECG	1.3	D.3-WPWB	Wolf-Parkinson type B
SCPECG	1.3	D.3-WPW	Wolf-Parkinson-White syndrome

**CID 3687      Electrophysiology Waveform Durations**

**Context ID 3687**  
**Electrophysiology Waveform Durations**  
Type: Extensible      Version: 20030327

Coding Scheme Designator	Coding Scheme Version	Code Value	Code Meaning
SCPECG	1.3	5.13.5-5	P Duration
SCPECG	1.3	5.13.5-7	PR Interval
SCPECG	1.3	5.13.5-9	QRS Duration
SCPECG	1.3	5.13.5-11	QT Interval
SCPECG	1.3	5.13.5-13	Q Duration
SCPECG	1.3	5.13.5-15	R Duration
SCPECG	1.3	5.13.5-17	S Duration
SCPECG	1.3	5.13.5-19	R' Duration
SCPECG	1.3	5.13.5-21	S' Duration
SCPECG	1.3	5.13.5-49	Isoelectric Segment duration at the onset of QRS
SCPECG	1.3	5.13.5-51	Isoelectric Segment duration at the end of QRS
SCPECG	1.3	5.13.5-53	Intrinsicoid Deflection duration

**CID 3688      Electrophysiology Waveform Voltages**

**Context ID 3688**  
**Electrophysiology Waveform Voltages**  
Type: Extensible      Version: 20030327

Coding Scheme Designator	Coding Scheme Version	Code Value	Code Meaning
--------------------------	-----------------------	------------	--------------

Designator	Version		
SCPECG	1.3	5.13.5-23	Q Amplitude
SCPECG	1.3	5.13.5-25	R Amplitude
SCPECG	1.3	5.13.5-27	S Amplitude
SCPECG	1.3	5.13.5-29	R' Amplitude
SCPECG	1.3	5.13.5-31	S' Amplitude
SCPECG	1.3	5.13.5-33	J Point Amplitude
SCPECG	1.3	5.13.5-35	P(+) Amplitude
SCPECG	1.3	5.13.5-37	P(-) Amplitude
SCPECG	1.3	5.13.5-39	T(+) Amplitude
SCPECG	1.3	5.13.5-41	T(-) Amplitude
SCPECG	1.3	5.13.5-57	ST Amplitude at the J-Point plus 20 ms
SCPECG	1.3	5.13.5-59	ST Amplitude at the J-Point plus 60 ms
SCPECG	1.3	5.13.5-61	ST Amplitude at the J-Point plus 80 ms
SCPECG	1.3	5.13.5-63	Amplitude at the J-Point plus 1/16 average R-R
SCPECG	1.3	5.13.5-65	Amplitude at the J-Point plus 1/8 average R-R

**CID 3700 Cath Diagnosis**

**Context ID 3700  
Cath Diagnosis**

**Type: Extensible**

**Version: 20030327**

Coding Scheme Designator	Code Value	Code Meaning
SRT	D3-13000	Coronary artery disease
SRT	D3-15100	Acute myocardial infarction
SRT	F-37012	Atypical chest pain
SRT	D3-13020	Stable Angina
SRT	D3-12400	Atypical Angina, Variant Angina
SRT	D3-12700	Unstable Angina, Progressive Angina
SRT	D3-13014	Post-infarction angina
SRT	R-00368	Recurrent angina Post-PTCA
SRT	R-00367	Recurrent angina Post-DCA
SRT	R-00369	Recurrent angina Post-Rotational Atherectomy
SRT	R-00366	Recurrent angina Post-Stent
SRT	R-00365	Recurrent angina Post-CABG
SRT	D3-16010	Congestive heart failure
SRT	D2-61100	Pulmonary edema
SRT	D3-00200	cardiogenic shock
SRT	R-002CB	Acute ventricular septal rupture



SRT	D3-29010	Mitral valve disease
SRT	D3-29011	Mitral stenosis
SRT	D3-29012	Mitral regurgitation
SRT	D3-29096	Acute mitral regurgitation
SRT	D3-13021	Silent ischemia
SRT	R-00336	s/p MI positive stress for ischemia
SRT	D3-26000	Myocarditis
SRT	D3-28012	Subacute bacterial endocarditis
SRT	D3-2906A	Idiopathic hypertrophic subaortic stenosis
SRT	D3-40300	Pulmonary hypertension
SRT	D3-29040	Tricuspid valve disease
SRT	D3-29042	Tricuspid regurgitation
SRT	D3-29013	Mitral valve prolapse
SRT	D3-31700	Ventricular tachycardia
SRT	D3-31720	Ventricular fibrillation
SRT	D3-21000	Congestive cardiomyopathy
SRT	D3-02500	Hypertensive heart disease
SRT	D3-22100	Restrictive cardiomyopathy
SRT	D3-90000	Pericardial disease
SRT	D3-90100	Pericardial tamponade
SRT	D3-29020	Aortic valve disease
SRT	D3-29021	Aortic stenosis
SRT	D3-29025	Aortic insufficiency
SRT	D4-31220	Atrial septal defect
SRT	D3-80016	Aortic dissection
SRT	D3-29050	Pulmonic valve disease
SRT	D4-31159	Ventricular septal defect
SRT	D3-83300	Aortic aneurysm
SRT	R-10042	Arrhythmia Evaluation
SRT	D3-31520	Atrial fibrillation
SRT	D4-31000	heart disease, congenital
SRT	D3-91030	Constrictive pericarditis

**CID 3701      Cardiac Valves and Tracts**

**Context ID 3701  
Cardiac Valves and Tracts**

**Type: Extensible      Version: 20030327**

<b>Coding Scheme Designator</b>	<b>Code Value</b>	<b>Code Meaning</b>
SRT	T-35300	Mitral Valve

- Standard -

SRT	T-35400	Aortic Valve
SRT	T-35100	Tricuspid valve
SRT	T-35200	Pulmonary valve
SRT	T-32650	Left ventricle outflow tract

**CID 3703 Wall Motion**

**Context ID 3703  
Wall Motion**

**Type: Extensible Version: 20030327**

<b>Coding Scheme Designator</b>	<b>Code Value</b>	<b>Code Meaning</b>
SRT	R-00378	Not Evaluated
SRT	R-41198	Unknown
DCM	122288	Not visualized
SRT	R-00344	Normal wall motion
SRT	R-0030D	Hyperkinetic region
SRT	R-4041B	Hypokinesis
SRT	F-32056	Mild Hypokinesis
SRT	R-0032F	Moderate Hypokinesis
SRT	R-00370	Severe Hypokinesis
SRT	F-30004	Akinesis
SRT	F-32052	Dyskinesis

**CID 3704 Myocardium Wall Morphology Findings**

**Context ID 3704  
Myocardium Wall Morphology Findings**

**Type: Extensible Version: 20030327**

<b>Coding Scheme Designator</b>	<b>Code Value</b>	<b>Code Meaning</b>
DCM	122112	Normal Myocardium
SRT	D3-10510	Ventricular Aneurysm
DCM	122113	Scarred Myocardium
DCM	122114	Thinning Myocardium

**CID 3705 Chamber Size**

**Context ID 3705  
Chamber Size**

- Standard -

**Type: Extensible**

**Version: 20030327**

<b>Coding Scheme Designator</b>	<b>Code Value</b>	<b>Code Meaning</b>
SRT	R-00343	Normal size cardiac chamber
SRT	R-002C6	Abnormally small cardiac chamber
SRT	R-0032A	Mildly Enlarged cardiac chamber
SRT	R-00331	Moderately Enlarged cardiac chamber
SRT	R-00316	Markedly Enlarged cardiac chamber

**CID 3706 Overall Contractility**

**Context ID 3706  
Overall Contractility**

**Type: Extensible**

**Version: 20030327**

<b>Coding Scheme Designator</b>	<b>Code Value</b>	<b>Code Meaning</b>
SRT	R-00341	Normal wall contractility
SRT	R-00398	Hyperkinesis
SRT	R-4041B	Hypokinesis
SRT	F-30004	Akinesis

**CID 3707 VSD Description**

**Context ID 3707  
VSD Description**

**Type: Extensible**

**Version: 20030327**

<b>Coding Scheme Designator</b>	<b>Code Value</b>	<b>Code Meaning</b>
SRT	D4-31154	Membranous
SRT	R-0033B	Non-restrictive
SRT	D4-31166	Restrictive
SRT	R-40775	None

**CID 3709 Aortic Root Description**

**Context ID 3709  
Aortic Root Description**

**Type: Extensible**

**Version: 20030327**

<b>Coding Scheme Designator</b>	<b>Code Value</b>	<b>Code Meaning</b>
---------------------------------	-------------------	---------------------

SRT	R-0033C	Normal Aortic Root
SRT	R-00301	Enlarged Aortic Root
SRT	R-002CD	Aneurysm of Aortic Root
SRT	R-002D1	Annular Abscess of Aortic Root
SRT	R-003A1	Post Stenotic Dilation
SRT	D3-83660	Ruptured Sinus of Valsalva

**CID 3710      Coronary Dominance**

**Context ID 3710  
Coronary Dominance**

**Type: Extensible      Version: 20030327**

<b>Coding Scheme Designator</b>	<b>Coding Scheme Version</b>	<b>Code Value</b>	<b>Code Meaning</b>
NCDR	2.0b	68-1	Left Coronary Dominance
NCDR	2.0b	68-2	Right Coronary Dominance
NCDR	2.0b	68-3	Mixed Coronary Dominance

**CID 3711      Valvular Abnormalities**

**Context ID 3711  
Valvular Abnormalities**

**Type: Extensible      Version: 20030327**

<b>Coding Scheme Designator</b>	<b>Code Value</b>	<b>Code Meaning</b>
SRT	D3-29001	Stenosis
SRT	F-32400	Regurgitation
SRT	R-0030B	Calcified Heart Valve
SRT	R-0030F	Immobile Heart Valve
SRT	R-00305	Heart Valve Flail
SRT	D3-28005	Valvular endocarditis

**CID 3712      Vessel Descriptors**

**Context ID 3712  
Vessel Descriptors**

**Type: Extensible      Version: 20030327**

<b>Coding Scheme Designator</b>	<b>Code Value</b>	<b>Code Meaning</b>
SRT	R-00389	Ulcerated
SRT	R-0036B	Restenotic
SRT	R-002E2	Bifurcation
SRT	R-002EF	Culprit
SRT	R-002CE	Aneurysmal
SRT	R-002FC	Diffuse Disease
SRT	R-00314	Luminal Irregularities
SRT	R-411C5	Muscle Bridge
SRT	R-10050	Stenotic
SRT	R-10051	Ectatic
SRT	G-A264	Calcified
SRT	M-35100	Thrombus
SRT	R-10048	Tortuous
SRT	R-10049	Stented

**CID 3713 TIMI Flow Characteristics**

**Context ID 3713**  
**TIMI Flow Characteristics**  
**Type: Extensible Version: 20030327**

<b>Coding Scheme Designator</b>	<b>Code Value</b>	<b>Code Meaning</b>	<b>NCDR Equivalent</b>
SRT	R-0037E	0: No Perfusion	106-0, 107-0
SRT	R-0037F	1: Penetration without Perfusion	106-1, 107-1
SRT	R-00381	2: Partial Perfusion	106-2, 107-2
SRT	R-00382	3: Complete Perfusion	106-3, 107-3

**CID 3714 Thrombus**

**Context ID 3714**  
**Thrombus**  
**Type: Extensible Version: 20030327**

<b>Coding Scheme Designator</b>	<b>Code Value</b>	<b>Code Meaning</b>
SRT	R-0033A	No Thrombus
SRT	R-00356	Possible Thrombus
SRT	R-002F1	Definite Thrombus
SRT	R-00371	Severe Thrombus

**CID 3715      Lesion Margin**

**Context ID 3715  
Lesion Margin**

**Type: Extensible      Version: 20050614**

<b>Coding Scheme Designator</b>	<b>Code Value</b>	<b>Code Meaning</b>
SRT	G-A545	Smooth
SRT	G-A402	Irregular
SRT	R-00335	Multiple Irregularities
SRT	R-403CC	Ulcerative

**CID 3716      Severity**

**Context ID 3716  
Severity**

**Type: Extensible      Version: 20030327**

<b>Coding Scheme Designator</b>	<b>Code Value</b>	<b>Code Meaning</b>
SRT	R-40775	None
SRT	R-404FA	Mild
SRT	R-00329	Mild to Moderate
SRT	G-A002	Moderate
SRT	R-00330	Moderate to Severe
SRT	G-A003	Severe

**CID 3717      Myocardial Wall Segments**

This 17-segment model of left ventricular myocardial wall segments uses the terminology specified in Manuel D. Cerqueira, et al., "Standardized Myocardial Segmentation and Nomenclature for Tomographic Imaging of the Heart", 2001

**Context ID 3717  
Myocardial Wall Segments**

**Type: Non-Extensible      Version: 20030327**

<b>Coding Scheme Designator</b>	<b>Code Value</b>	<b>Code Meaning</b>
SRT	T-32619	left ventricle basal anterior segment
SRT	R-10075	left ventricle basal anteroseptal segment
SRT	R-10076	left ventricle basal inferoseptal segment

SRT	T-32615	left ventricle basal inferior segment
SRT	R-10079	left ventricle basal inferolateral segment
SRT	R-1007A	left ventricle basal anterolateral segment
SRT	T-32617	left ventricle mid anterior segment
SRT	R-10077	left ventricle mid anteroseptal segment
SRT	R-10078	left ventricle mid inferoseptal segment
SRT	T-32616	left ventricle mid inferior segment
SRT	R-1007B	left ventricle mid inferolateral segment
SRT	R-1007C	left ventricle mid anterolateral segment
SRT	T-32613	left ventricle apical anterior segment
SRT	T-32614	left ventricle apical septal segment
SRT	T-32618	left ventricle apical inferior segment
SRT	T-3261C	left ventricle apical lateral segment
SRT	T-32602	apex of left ventricle

**CID 3718 Myocardial Wall Segments in Projection**

This context group specifies the left ventricular myocardial wall segments as seen in typical right anterior oblique (RAO) and left anterior oblique (LAO) angiographic projections.

**Context ID 3718**  
**Myocardial Wall Segments in Projection**  
**Type: Extensible                      Version: 20030614**

<b>Coding Scheme Designator</b>	<b>Code Value</b>	<b>Code Meaning</b>
SRT	T-32619	left ventricle basal anterior segment
SRT	T-32634	myocardium of anterolateral region
SRT	T-32636	myocardium of apex of heart
SRT	T-32632	myocardium of diaphragmatic region
SRT	T-32615	left ventricle basal inferior segment
SRT	T-32603	left ventricle basal lateral segment
SRT	T-32633	myocardium of posterolateral region
SRT	T-32637	myocardium of inferolateral region
SRT	T-32614	left ventricle apical septal segment
SRT	T-32601	left ventricular basal septal segment
SRT	R-101C0	left ventricular posterobasal segment

**CID 3719 Canadian Clinical Classification**

**Context ID 3719**  
**Canadian Clinical Classification**  
**Type: Extensible Version: 20030327**

<b>Coding Scheme Designator</b>	<b>Coding Scheme Version</b>	<b>Code Value</b>	<b>Code Meaning</b>
NCDR	2.0b	50-0	Class 0
NCDR	2.0b	50-I	Class I
NCDR	2.0b	50-II	Class II
NCDR	2.0b	50-III	Class III
NCDR	2.0b	50-IV	Class IV

**CID 3720 Cardiac History Dates**

**Context ID 3720**  
**Cardiac History Dates**  
**Type: Extensible Version: 20030327**

<b>Coding Scheme Designator</b>	<b>Coding Scheme Version</b>	<b>Code Value</b>	<b>Code Meaning</b>
NCDR	2.0b	41	Date of Previous Percutaneous Coronary Intervention
NCDR	2.0b	43	Date of Previous Coronary Artery Bypass Graft
NCDR	2.0b	45	Date of Previous Valvular Surgery

**CID 3721 Cath Patient History**

**Context ID 3721**  
**Cath Patient History**  
**Type: Extensible Version: 20030327**

<b>Coding Scheme Designator</b>	<b>Coding Scheme Version</b>	<b>Code Value</b>	<b>Code Meaning</b>
NCDR	2.0b	40	previous precutaneous coronary intervention
NCDR	2.0b	42	previous cardiovascular surgery
NCDR	2.0b	44	previous valvular surgery
NCDR	2.0b	29	family history of coronary artery disease

**CID 3722 Diabetic Therapy**



**Context ID 3722  
Diabetic Therapy**

**Type: Extensible                      Version: 20030327**

<b>Coding Scheme Designator</b>	<b>Coding Scheme Version</b>	<b>Code Value</b>	<b>Code Meaning</b>
NCDR	2.0b	31-1	Diet
NCDR	2.0b	31-2	Oral Agent Treatment
NCDR	2.0b	31-3	Insulin

**CID 3723                      MI Types**

**Context ID 3723  
MI Types**

**Type: Extensible                      Version: 20030327**

<b>Coding Scheme Designator</b>	<b>Coding Scheme Version</b>	<b>Code Value</b>	<b>Code Meaning</b>
NCDR	2.0b	94-1	Non ST Elevation Myocardial Infarction
NCDR	2.0b	94-2	ST Elevation Myocardial Infarction
NCDR	2.0b	94-0	No documented Myocardial Infarction

**CID 3724                      Smoking History**

**Context ID 3724  
Smoking History**

**Type: Extensible                      Version: 20030327**

<b>Coding Scheme Designator</b>	<b>Coding Scheme Version</b>	<b>Code Value</b>	<b>Code Meaning</b>
NCDR	2.0b	38-0	No History of Smoking
NCDR	2.0b	38-1	Current Smoker
NCDR	2.0b	38-2	Former Smoker

**CID 3726 Indications for Coronary Intervention**

**Context ID 3726**  
**Indications for Coronary Intervention**  
**Type: Extensible Version: 20030327**

<b>Coding Scheme Designator</b>	<b>Code Value</b>	<b>Code Meaning</b>	<b>NCDR Equivalent</b>
DCM	122171	Coronary lesion >= 50% stenosis	
SRT	D3-00200	Cardiogenic Shock	123

**CID 3727 Indications for Catheterization**

**Context ID 3727**  
**Indications for Catheterization**  
**Type: Extensible Version: 20030327**

<b>Coding Scheme Designator</b>	<b>Coding Scheme Version</b>	<b>Code Value</b>	<b>Code Meaning</b>
NCDR	2.0b	79	cardiogenic shock
NCDR	2.0b	80	valvular heart disease
NCDR	2.0b	81	Arrhythmia
NCDR	2.0b	82	ischemic heart disease
NCDR	2.0b	83	positive functional tests
NCDR	2.0b	84.1	heart disease - transplant
NCDR	2.0b	84.2	heart disease - congenital
NCDR	2.0b	84.3	heart disease - cardiomyopathy
NCDR	2.0b	84.4	heart disease of other etiology

**CID 3728 Cath Findings**

**Context ID 3728**  
**Cath Findings**  
**Type: Extensible Version: 20030327**

<b>Coding Scheme Designator</b>	<b>Code Value</b>	<b>Code Meaning</b>
SRT	R-0033F	Normal left heart hemodynamics
SRT	R-00342	Normal right heart hemodynamics
SRT	R-0033E	Normal left and right heart hemodynamics
SRT	R-00340	Normal left ventricular systolic function and wall motion

SRT	R-0033D	Normal coronary arteries
SRT	R-00328	Mild intimal coronary irregularities, no significant stenoses
SRT	R-00374	Single vessel coronary artery disease.
SRT	R-002FE	Double vessel coronary artery disease.
SRT	R-00386	Triple vessel coronary artery disease.
SRT	R-00334	Multi vessel coronary artery disease.
SRT	R-00313	Left main coronary artery disease
SRT	R-00372	Significant coronary bypass graft disease
SRT	D3-29021	Aortic stenosis
SRT	D3-29025	Aortic insufficiency
SRT	D3-29011	Mitral stenosis
SRT	D3-29012	Mitral regurgitation
SRT	R-002F3	Depression of left ventricular systolic function
SRT	R-002C8	Acute mitral regurgitation from chordal rupture
SRT	R-002C7	Acute mitral regurgitation from chordal dysfunction
SRT	R-002CA	Acute mitral regurgitation from papillary muscle rupture
SRT	R-002C9	Acute mitral regurgitation from papillary muscle dysfunction
SRT	D3-29013	Mitral valve prolapse
SRT	D3-2100	Congestive cardiomyopathy
SRT	D3-23000	Hypertrophic cardiomyopathy with obstruction
SRT	D3-20003	Hypertrophic cardiomyopathy without obstruction
SRT	D3-02500	Hypertensive heart disease
SRT	D3-22100	Restrictive cardiomyopathy
SRT	D3-90100	Pericardial tamponade
SRT	D3-91030	Constrictive pericarditis
SRT	D3-40300	Pulmonary hypertension
SRT	D4-31220	Atrial septal defect
SRT	D4-31159	Ventricular septal defect
SRT	R-002CB	Acute ventricular septal rupture
SRT	D4-31000	heart disease - congenital

**CID 3729 Admission Status**

**Context ID 3729  
Admission Status**

**Type: Extensible**

**Version: 20030327**

<b>Coding Scheme Designator</b>	<b>Coding Scheme Version</b>	<b>Code Value</b>	<b>Code Meaning</b>
NCDR	2.0b	17-1	Referral / Elective
NCDR	2.0b	17-2	Emergency Department
NCDR	2.0b	17-3	Transfer
NCDR	2.0b	17-4	Other

**CID 3730 Insurance Payor**

**Context ID 3730  
Insurance Payor**

**Type: Extensible**

**Version: 20030327**

<b>Coding Scheme Designator</b>	<b>Coding Scheme Version</b>	<b>Code Value</b>	<b>Code Meaning</b>
NCDR	2.0b	18-1	Government
NCDR	2.0b	18-2	Commercial
NCDR	2.0b	18-3	Health Maintenance Organization
NCDR	2.0b	18-4	None

**CID 3733 Primary Cause of Death**

**Context ID 3733  
Primary Cause of Death**

**Type: Extensible**

**Version: 20030327**

<b>Coding Scheme Designator</b>	<b>Coding Scheme Version</b>	<b>Code Value</b>	<b>Code Meaning</b>
NCDR	2.0b	25-1	Cardiac
NCDR	2.0b	25-2	Neurologic
NCDR	2.0b	25-3	Renal
NCDR	2.0b	25-4	Vascular
NCDR	2.0b	25-5	Infection
NCDR	2.0b	25-6	Pulmonary
NCDR	2.0b	25-7	Valvular

NCDR	2.0b	25-8	Other
------	------	------	-------

**CID 3735 Acute Coronary Syndrome Time Period**

**Context ID 3735  
Acute Coronary Syndrome Time Period**

**Type: Extensible Version: 20030327**

Coding Scheme Designator	Coding Scheme Version	Code Value	Code Meaning
NCDR	2.0b	51-1	<= 6 hours
NCDR	2.0b	51-2	between 6 hours and 24 hours
NCDR	2.0b	51-3	between 24 hours and 7 days

**CID 3736 NYHA Classification**

**Context ID 3736  
NYHA Classification**

**Type: Extensible Version: 20030327**

Coding Scheme Designator	Coding Scheme Version	Code Value	Code Meaning
NCDR	2.0b	47-I	NYHA Class I
NCDR	2.0b	47-II	NYHA Class II
NCDR	2.0b	47-III	NYHA Class III
NCDR	2.0b	47-IV	NYHA Class IV

**CID 3737 Non-Invasive Test - Ischemia**

**Context ID 3737  
Non-Invasive Test - Ischemia**

**Type: Extensible Version: 20030327**

Coding Scheme Designator	Coding Scheme Version	Code Value	Code Meaning
NCDR	2.0b	48-1	Not Done
NCDR	2.0b	48-2	Positive
NCDR	2.0b	48-3	Negative
NCDR	2.0b	48-4	Equivocal
NCDR	2.0b	48-5	Arrhythmia

**CID 3738 Pre-Cath Angina Type**

**Context ID 3738  
Pre-Cath Angina Type**

**Type: Extensible Version: 20030327**

<b>Coding Scheme Designator</b>	<b>Coding Scheme Version</b>	<b>Code Value</b>	<b>Code Meaning</b>
NCDR	2.0b	49-I	Atypical Chest Pain
NCDR	2.0b	49-II	Stable Angina
NCDR	2.0b	49-IIIa	Acute Coronary Syndrome: Unstable Angina
NCDR	2.0b	49-IIIb	Acute Coronary Syndrome: Non ST-Elevation Myocardial Infarction
NCDR	2.0b	49-IIIc	Acute Coronary Syndrome: ST-Elevation Myocardial Infarction

**CID 3739 Cath Procedure Type**

**Context ID 3739  
Cath Procedure Type**

**Type: Extensible Version: 20030327**

<b>Coding Scheme Designator</b>	<b>Code Value</b>	<b>Code Meaning</b>	<b>NCDR Equivalent</b>
SRT	P1-31602	Catheterization of right heart	54-1
SRT	P1-31604	Catheterization of left heart	54-2
SRT	P1-3160A	Catheterization of both left and right heart with graft	
SRT	P1-3160B	Catheterization of both left and right heart without graft	
DCM	122061	Percutaneous Coronary Intervention	54-3

**CID 3740 Thrombolytic Administration**

**Context ID 3740  
Thrombolytic Administration**

**Type: Extensible Version: 20030327**

<b>Coding Scheme Designator</b>	<b>Code Value</b>	<b>Code Meaning</b>	<b>NCDR Equivalent</b>
SRT	R-0037D	Contraindicated	57-1
SRT	R-0037C	Administered less than 3 hours before PCI	57-2
SRT	R-0037A	Administered between 3 and 6 hours	57-3

		before PCI	
SRT	R-0037B	Administered between 6 hours and 7 days before PCI	57-4

**CID 3741 Medication Administration, Lab Visit**

**Context ID 3741  
Medication Administration, Lab Visit**

**Type: Extensible Version: 20030327**

<b>Coding Scheme Designator</b>	<b>Code Value</b>	<b>Code Meaning</b>	<b>NCDR Equivalent</b>
SRT	R-00321	Contraindicated	58-1
SRT	R-0031B	Administered before lab visit	58-2
SRT	R-0031C	Administered during lab visit	58-3
SRT	R-0031A	Administered after lab visit	58-4

**CID 3742 Medication Administration, PCI**

**Context ID 3742  
Medication Administration, PCI**

**Type: Extensible Version: 20030327**

<b>Coding Scheme Designator</b>	<b>Code Value</b>	<b>Code Meaning</b>	<b>NCDR Equivalent</b>
SRT	R-00320	Not Administered	
SRT	R-00321	Contraindicated	59-1
SRT	R-0031F	Administered Prior to Percutaneous Coronary Intervention	59-2
SRT	R-0039A	Administered During Percutaneous Coronary Intervention	59-3
SRT	R-00399	Administered After Percutaneous Coronary Intervention	59-4

**CID 3743 Clopidogrel/Ticlopidine Administration**

**Context ID 3743  
Clopidogrel/Ticlopidine Administration**

**Type: Extensible Version: 20030327**

<b>Coding Scheme Designator</b>	<b>Code Value</b>	<b>Code Meaning</b>	<b>NCDR Equivalent</b>
SRT	R-00320	Not Administered	60-1
SRT	R-00321	Contraindicated	60-2
SRT	R-0031E	Administered Less than 72 Hours before PCI	60-3
SRT	R-00399	Administered After Percutaneous Coronary Intervention	60-4

**CID 3744 EF Testing Method**

**Context ID 3744  
EF Testing Method**

**Type: Extensible Version: 20030327**

<b>Coding Scheme Designator</b>	<b>Code Value</b>	<b>Code Meaning</b>
SRT	P5-3003A	Cardiac ventriculography
SRT	P5-D3300	Radionuclide ventriculography
SRT	P5-B3081	Adult echocardiography

**CID 3745 Calculation Method**

**Context ID 3745  
Calculation Method**

**Type: Extensible Version: 20050110**

<b>Coding Scheme Designator</b>	<b>Code Value</b>	<b>Code Meaning</b>
SRT	R-10260	Estimated
SRT	R-41D2D	Calculated



**CID 3746 Percutaneous Entry**

**Context ID 3746  
Percutaneous Entry Site**

**Type: Extensible**

**Version: 20030327**

<b>Coding Scheme Designator</b>	<b>Coding Scheme Version</b>	<b>Code Value</b>	<b>Code Meaning</b>
NCDR	2.0b	74-1	Percutaneous entry made via femoral artery
NCDR	2.0b	74-2	Percutaneous entry made via brachial artery
NCDR	2.0b	74-3	Percutaneous entry made via radial artery
NCDR	2.0b	74-4	Percutaneous entry made via other artery
NCDR	2.0b	74-5	Percutaneous entry made via venous access

**CID 3747 Percutaneous Closure**

**Context ID 3747  
Percutaneous Closure**

**Type: Extensible**

**Version: 20030327**

<b>Coding Scheme Designator</b>	<b>Coding Scheme Version</b>	<b>Code Value</b>	<b>Code Meaning</b>
NCDR	2.0b	75-0	No closure device used at percutaneous entry
NCDR	2.0b	75-1	Percutaneous entry closed by suture
NCDR	2.0b	75-2	Percutaneous entry closed by sealant
NCDR	2.0b	75-3	Percutaneous entry closed by other mechanism

**CID 3748 Angiographic EF Testing Method**

**Context ID 3748  
Angiographic EF Testing Method**

**Type: Extensible**

**Version: 20030327**

<b>Coding Scheme Designator</b>	<b>Code Value</b>	<b>Code Meaning</b>
DCM	122059	Single plane Angiography
DCM	122060	Bi-plane Angiography

**CID 3749      PCI Procedure Result**

**Context ID 3749  
PCI Procedure Result**

**Type: Extensible      Version: 20030327**

<b>Coding Scheme Designator</b>	<b>Coding Scheme Version</b>	<b>Code Value</b>	<b>Code Meaning</b>
NCDR	2.0b	100-1	Successful
NCDR	2.0b	100-2	Partially successful
NCDR	2.0b	100-3	Unsuccessful

**CID 3750      Previously Dilated Lesion**

**Context ID 3750  
Previously Dilated Lesion**

**Type: Extensible      Version: 20030327**

<b>Coding Scheme Designator</b>	<b>Coding Scheme Version</b>	<b>Code Value</b>	<b>Code Meaning</b>
NCDR	2.0b	108-0	not previously treated
NCDR	2.0b	108-1	balloon only
NCDR	2.0b	108-2	stent only
NCDR	2.0b	108-3	other/any combination

**CID 3752      Guidewire Crossing**

**Context ID 3752  
Guidewire Crossing**

**Type: Extensible      Version: 20030327**

<b>Coding Scheme Designator</b>	<b>Code Value</b>	<b>Code Meaning</b>
DCM	122301	Guidewire crossing lesion unsuccessful
DCM	122302	Guidewire crossing lesion successful

**CID 3754      Vascular Complications**

**Context ID 3754  
Vascular Complications**

**Type: Extensible      Version: 20050110**

<b>Coding Scheme Designator</b>	<b>Code Value</b>	<b>Code Meaning</b>	<b>NCDR 2.0b Equivalent Code Value</b>
SRT	M-37000	Bleeding	127
SRT	D3-89100	Occlusion of artery	128
SRT	R-102B2	Loss of distal pulse	129
SRT	D3-81310	Arterial dissection	130
SRT	M-32390	Pseudoaneurysm	131
SRT	M-39390	AV Fistula	132

Note: In prior editions, this Context Group included the NCDR 2.0b codes as the primary set. These have been replaced with equivalent SNOMED codes.

**CID 3755      Cath Complications**

**Context ID 3755  
Cath Complications**

**Type: Extensible      Version: 20050110**

<b>Coding Scheme Designator</b>	<b>Code Value</b>	<b>Code Meaning</b>	<b>NCDR 2.0b Equivalent Code Value</b>
SRT	D3-00200	Cardiogenic shock	123
SRT	D3-30000	Arrhythmia	124
SRT	D3-8900D	Cerebrovascular Accident or Stroke	125
SRT	D3-90100	Cardiac tamponade	126
SRT	DF-10781	Contrast media adverse reaction	133
SRT	D3-16010	Congestive heart failure	134
SRT	D7-11010	Renal failure	135
SRT	R-102B5	Emergency Percutaneous Coronary Intervention	136
SRT	R-102B3	Emergency Coronary Artery Bypass	137
SRT	D3-30800	Cardiac arrest	

Note: In prior editions, this Context Group included the NCDR 2.0b codes as the primary set. These have been replaced with equivalent SNOMED codes.

**CID 3756 Cath Patient Risk Factors**

**Context ID 3756  
Cath Patient Risk Factors**

**Type: Extensible Version: 20050110**

<b>Coding Scheme Designator</b>	<b>Code Value</b>	<b>Code Meaning</b>	<b>NCDR 2.0b Equivalent Code Value</b>
SRT	G-026D	History of congestive heart failure	30
SRT	G-023F	History of Diabetes	31
SRT	R-102B6	History of renal failure	32
SRT	R-102B7	History of chronic lung disease	33
SRT	G-0102	History of cerebrovascular disease	34
SRT	D3-8005B	Peripheral vascular disease	35
SRT	G-0269	History of Hypertension	37
SRT	R-102B8	History of hypercholesterolemia	39

Note: In prior editions, this Context Group included the NCDR 2.0b codes as the primary set. These have been replaced with equivalent SNOMED codes.

**CID 3802 Plaque Structures**

**Context ID 3802  
Plaque Structures**

**Type: Extensible Version: 20051103**

<b>Coding Scheme Designator (0008,0102)</b>	<b>Code Value (0008,0100)</b>	<b>Code Meaning (0008,0104)</b>
SRT	R-40448	fibrous
SRT	M-50080	fatty degeneration
SRT	M-55420	pathologic calcification
SRT	M-72000	hyperplasia
SRT	G-A265	non-calcified
SRT	G-A660	mixed

**CID 3804      Stenosis Measurement Methods**

**Context ID 3804**

**Stenosis Measurement Methods**

**Type: Extensible      Version: 20051103**

<b>Coding Scheme Designator (0008,0102)</b>	<b>Code Value (0008,0100)</b>	<b>Code Meaning (0008,0104)</b>
DCM	122655	NASCET
DCM	122656	ECST
DCM	122650	Area Based Method
DCM	122651	Diameter Based Method

**CID 3805      Stenosis Types**

**Context ID 3805**

**Stenosis Types**

**Type: Extensible      Version: 20051103**

<b>Coding Scheme Designator (0008,0102)</b>	<b>Code Value (0008,0100)</b>	<b>Code Meaning (0008,0104)</b>
SRT	D3-81100	arteriosclerotic vascular disease
SRT	M-01460	compression
SRT	R-40448	fibrous
SRT	D3-80505	Raynaud's disease
SRT	M-300F2	entrapment
SRT	D3-80650	vasculitis
SRT	R-423C3	thrombosis
SRT	M-35300	embolism
SRT	D3-80033	cystic adventitial disease

**CID 3806      Stenosis Shape**

**Context ID 3806**

**Stenosis Shape**

**Type: Extensible      Version: 20051103**

<b>Coding Scheme Designator (0008,0102)</b>	<b>Code Value (0008,0100)</b>	<b>Code Meaning (0008,0104)</b>
SRT	R-4047B	concentric
SRT	R-40416	eccentric

**CID 3807      Volume Measurement Methods**

**Context ID 3807**

**Volume Measurement Methods**

**Type: Extensible      Version: 20051103**

<b>Coding Scheme Designator (0008,0102)</b>	<b>Code Value (0008,0100)</b>	<b>Code Meaning (0008,0104)</b>
DCM	122650	Area Based Method
DCM	122651	Diameter Based Method
DCM	122652	Volume Based Method

**CID 3808      Aneurysm Types**

**Context ID 3808**

**Aneurysm Types**

**Type: Extensible      Version: 20051103**

<b>Coding Scheme Designator (0008,0102)</b>	<b>Code Value (0008,0100)</b>	<b>Code Meaning (0008,0104)</b>
SRT	M-32270	dissecting aneurysm
SRT	D3-80017	inflammatory aneurysm
SRT	M-32201	ruptured aneurysm
SRT	M-24614	berry aneurysm
SRT	M-32240	mixed aneurysm
SRT	M-32410	racemose aneurysm
SRT	D3-80002	cirroid aneurysm
SRT	M-32320	mycotic aneurysm
SRT	M-32206	compound aneurysm
SRT	M-32310	miliary aneurysm
SRT	M-32340	saccular aneurysm
SRT	M-32221	varicose aneurysm
SRT	M-32350	fusiform aneurysm
SRT	M-32210	traumatic aneurysm
SRT	M-32202	thrombosed aneurysm
SRT	M-32203	expanding aneurysm
SRT	M-32204	calcified aneurysm
SRT	M-32208	multiple aneurysm
SRT	M-32360	cylindroid aneurysm
SRT	M-32260	serpentine aneurysm

**CID 3809 Associated Conditions**

**Context ID 3809**

**Associated Conditions**

**Type: Extensible Version: 20051103**

<b>Coding Scheme Designator (0008,0102)</b>	<b>Code Value (0008,0100)</b>	<b>Code Meaning (0008,0104)</b>
SRT	D6-90600	Marfan's Syndrome
SRT	M-10000	Traumatic Abnormality

**CID 3810 Vascular Morphology**

**Context ID 3810**

**Vascular Morphology**

**Type: Extensible Version: 20051103**

<b>Coding Scheme Designator (0008,0102)</b>	<b>Code Value (0008,0100)</b>	<b>Code Meaning (0008,0104)</b>
SRT	M-01470	plaque
SRT	M-34200	stenosis
SRT	M-32200	aneurysm
SRT	D3-81310	arterial dissection
SRT	A-25500	stent
SRT	M-34000	occlusion
SRT	M-39390	arteriovenous fistula
SRT	M-91200	angioma
SRT	M-32000	dilatation
SRT	R-FAB5E	vascular coiling
SRT	M-31790	tortuosity
SRT	M-32700	diverticulum
SRT	M-520F8	vascular sclerosis
SRT	D-80515	thrombosis
SRT	M-32390	pseudoaneurysm
SRT	M-35300	embolism
SRT	M-74880	fibromuscular dysplasia

**CID 3813      Stent Findings**

**Context ID 3813**

**Stent Findings**

**Type: Extensible      Version: 20051103**

<b>Coding Scheme Designator (0008,0102)</b>	<b>Code Value (0008,0100)</b>	<b>Code Meaning (0008,0104)</b>
SRT	M-75300	hypoplasia
SRT	M-34200	stenosis
DCM	122680	endoleak
SRT	DD-661D2	migration of implant or internal device
DCM	122684	stent disintegration
DCM	122683	stent fracture

**CID 3814      Stent Composition**

**Context ID 3814**

**Stent Composition**

**Type: Extensible      Version: 20051103**

<b>Coding Scheme Designator (0008,0102)</b>	<b>Code Value (0008,0100)</b>	<b>Code Meaning (0008,0104)</b>
SRT	A-25502	metal stent
SRT	A-25501	plastic stent

**CID 3815      Source of Vascular Finding**

**Context Group 3815**

**Source of Vascular Finding**

**Type: Extensible      Version: 20051103**

<b>Coding Scheme Designator (0008,0102)</b>	<b>Code Value (0008,0100)</b>	<b>Code Meaning (0008,0104)</b>
SRT	D3-80515	thrombosis
SRT	M-35300	embolism
SRT	M-72000	hyperplasia
SRT	D3-80650	vasculitis
SRT	M-8FFFF	tumor
SRT	DD-00001	trauma
SRT	G-B102	surgical



<b>Coding Scheme Designator (0008,0102)</b>	<b>Code Value (0008,0100)</b>	<b>Code Meaning (0008,0104)</b>
SRT	R-422A4	after procedure

**CID 3817 Vascular Sclerosis Types**

**Context ID 3817**

**Vascular Sclerosis Types**

**Type: Extensible Version: 20051103**

<b>Coding Scheme Designator (0008,0102)</b>	<b>Code Value (0008,0100)</b>	<b>Code Meaning (0008,0104)</b>
SRT	M-52450	adventitial degeneration
SRT	M-52210	arteriosclerosis with fibrinoid necrosis
SRT	M-52200	arteriolosclerosis
SRT	M-52000	arteriosclerosis
SRT	M-52100	atheroma
SRT	M-52120	atherosclerotic fibrous plaque
SRT	M-52101	calcified atheromatous plaque
SRT	M-52102	complicated atheromatous plaque
SRT	M-52470	cystic medial necrosis
SRT	M-52240	elastic vascular sclerosis
SRT	M-52130	fatty streaks
SRT	M-52300	fibroelastosis
SRT	M-52302	diffuse fibroelastosis
SRT	M-52301	focal fibroelastosis
SRT	M-52500	phlebosclerosis
SRT	M-52103	ulcerated atheromatous plaque
SRT	M-52400	vascular wall degeneration

**CID 3820 Non-invasive Vascular Procedures**

**Context ID 3820**

**Non-invasive Vascular Procedures**

**Type: Extensible Version: 20051103**

<b>Coding Scheme Designator (0008,0102)</b>	<b>Code Value (0008,0100)</b>	<b>Code Meaning (0008,0104)</b>
SRT	P5-0903A	vascular MRI
SRT	P5-09011	cardiac MRI
SRT	P5-0807F	cardiovascular CT
SRT	P5-0802B	CT of abdominal aorta
SRT	P5-00A0D	trunk angiography
SRT	P5-009BF	peripheral angiography

**CID 3821 Papillary Muscle Included/Excluded**

**Context ID 3821**

**Papillary Muscle Included/Excluded**

**Type: Extensible Version: 20051103**

<b>Coding Scheme Designator (0008,0102)</b>	<b>Code Value (0008,0100)</b>	<b>Code Meaning (0008,0104)</b>
DCM	122620	Papillary Muscle Excluded
DCM	122621	Papillary Muscle Included

**CID 3823 Respiratory Status**

**Context ID 3823**

**Respiratory Status**

**Type: Extensible Version: 20051103**

<b>Coding Scheme Designator (0008,0102)</b>	<b>Code Value (0008,0100)</b>	<b>Code Meaning (0008,0104)</b>
SRT	F-20010	inspiration
SRT	F-20020	expiration
SRT	F-20030	autonomous breathing
SRT	R-40928	Valsalva maneuver
DCM	122612	central breathing position
SRT	F-201BD	shallow breathing

**CID 3826      Heart Rhythm**

**Context ID 3826**

**Heart Rhythm**

**Type: Extensible      Version: 20051103**

<b>Coding Scheme Designator (0008,0102)</b>	<b>Code Value (0008,0100)</b>	<b>Code Meaning (0008,0104)</b>
SRT	F-33300	normal sinus rhythm
SRT	D3-31500	atrial arrhythmia
SRT	D3-31715	ventricular arrhythmia

**CID 3827      Vessel Segments**

**Context ID 3827**

**Vessel Segments**

**Type: Extensible      Version: 20051103**

<b>Coding Scheme Designator (0008,0102)</b>	<b>Code Value (0008,0100)</b>	<b>Code Meaning (0008,0104)</b>
		INCLUDE CID(12105) Intracranial Cerebral Vessels
		INCLUDE CID(12106) Unpaired Cerebral Vessels
		INCLUDE CID(12104) Extracranial Arteries
		INCLUDE CID(12109) Lower Extremity Arteries
		INCLUDE CID(12110) Lower Extremity Veins
		INCLUDE CID(12107) Upper Extremity Arteries
		INCLUDE CID(12108) Upper Extremity Veins
		INCLUDE CID(12115) Renal Vessels
		INCLUDE CID(12111) Abdominal Arteries (lateral)
		INCLUDE CID(12112) Abdominal Arteries (unilateral)
		INCLUDE CID(12113) Abdominal Veins (lateral)
		INCLUDE CID(12114) Abdominal Veins (unilateral)
		INCLUDE CID(3015) Coronary Arteries
		INCLUDE CID(3839) Cardiac Veins
		INCLUDE CID(3840) Pulmonary Veins

**CID 3829 Pulmonary Arteries**

**Context ID 3829  
Pulmonary Arteries**

**Type: Extensible Version: 20051103**

<b>Coding Scheme Designator (0008,0102)</b>	<b>Code Value (0008,0100)</b>	<b>Code Meaning (0008,0104)</b>
SRT	T-44101	entire trunk of pulmonary artery
SRT	T-44011	entire suprapulmonic valve area
SRT	T-35250	pulmonary valve sinuses
SRT	T-44401	entire left pulmonary artery
SRT	T-44201	entire right pulmonary artery

**CID 3831 Stenosis Length**

**Context ID 3831  
Stenosis Length**

**Type: Extensible Version: 20051103**

<b>Coding Scheme Designator (0008,0102)</b>	<b>Code Value (0008,0100)</b>	<b>Code Meaning (0008,0104)</b>
SRT	R-404AC	long
SRT	R-4235F	short

**CID 3832 Stenosis Grade**

**Context ID 3832  
Stenosis Grade**

**Type: Extensible Version: 20051103**

<b>Coding Scheme Designator (0008,0102)</b>	<b>Code Value (0008,0100)</b>	<b>Code Meaning (0008,0104)</b>
SRT	G-A003	severe
SRT	G-A002	moderate
SRT	R-404FA	mild

**CID 3833      Cardiac Ejection Fraction**

**Context ID 3833  
Cardiac Ejection Fraction**

**Type: Extensible      Version: 20051103**

<b>Coding Scheme Designator (0008,0102)</b>	<b>Code Value (0008,0100)</b>	<b>Code Meaning (0008,0104)</b>
LN	8810-4	Left ventricular ejection fraction by CT
LN	8817-9	Right ventricular ejection fraction by CT
LN	8811-2	Left ventricular ejection fraction by MR
LN	8818-7	Right ventricular ejection fraction by MR

**CID 3835      Volume Measurements**

**Context ID 3835  
Volume Measurements**

**Type: Extensible      Version: 20051103**

<b>Coding Scheme Designator (0008,0102)</b>	<b>Code Value (0008,0100)</b>	<b>Code Meaning (0008,0104)</b>
INCLUDE CID(3468) ED Volume		
INCLUDE CID(3469) ES Volume		
SRT	F-32120	stroke volume

**CID 3836      Time-based Perfusion Measurements**

**Context ID 3836  
Time-based Perfusion Measurements**

**Type: Extensible      Version: 20051103**

<b>Coding Scheme Designator (0008,0102)</b>	<b>Code Value (0008,0100)</b>	<b>Code Meaning (0008,0104)</b>
DCM	122631	Signal Earliest Peak Time
DCM	122633	Signal Increase Start Time
DCM	122634	Signal Time to Peak
DCM	122638	Signal Baseline Start
DCM	122639	Signal Baseline End

**CID 3837      Fiducial Feature**

**Context ID 3837  
Fiducial Feature**

**Type: Extensible      Version: 20051103**

<b>Coding Scheme Designator (0008,0102)</b>	<b>Code Value (0008,0100)</b>	<b>Code Meaning (0008,0104)</b>
SRT	T-3215A	Ostium
SRT	T-46600	Renal Artery
SRT	T-42580	Aortic Bifurcation
SRT	R-10258	Common Iliac Bifurcation

**CID 3838      Diameter Derivation**

**Context ID 3838  
Diameter Derivation**

**Type: Extensible      Version: 20051103**

<b>Coding Scheme Designator (0008,0102)</b>	<b>Code Value (0008,0100)</b>	<b>Code Meaning (0008,0104)</b>
INCLUDE CID(3488) Min/Max/Mean		
SRT	G-A117	Transverse
DCM	122675	Anterior-Posterior

**CID 3839      Coronary Veins**

**Context ID 3839  
Coronary Veins**

**Type: Extensible      Version: 20051103**

<b>Coding Scheme Designator (0008,0102)</b>	<b>Code Value (0008,0100)</b>	<b>Code Meaning (0008,0104)</b>
SRT	T-48343	Azygos Vein
SRT	T-48418	Coronary Sinus
SRT	T-48421	Great Cardiac Vein
SRT	T-48436	Small Cardiac Vein
SRT	T-48440	Anterior Cardiac Vein
SRT	T-484A1	Atrial Vein
SRT	T-484A3	Atrioventricular Vein
SRT	T-48431	Middle Cardiac Vein
SRT	T-484A2	Ventricular Vein
SRT	T-48405	Smallest Cardiac Vein

**CID 3840      Pulmonary Veins**

**Context ID 3840  
Pulmonary Veins**

**Type: Extensible      Version: 20051103**

<b>Coding Scheme Designator (0008,0102)</b>	<b>Code Value (0008,0100)</b>	<b>Code Meaning (0008,0104)</b>
SRT	T-48500	Entire Pulmonary Vein
SRT	T-4858E	Entire Left Pulmonary Vein
SRT	T-4854B	Entire Inferior Left Pulmonary Vein
SRT	T-48537	Entire Superior Left Pulmonary Vein
SRT	T-48504	Entire Right Pulmonary Vein
SRT	T-48526	Entire Inferior Right Pulmonary Vein
SRT	T-48515	Entire Superior Right Pulmonary Vein

**CID 3843      Myocardial Subsegment**

**Context ID 3843**

**Myocardial Subsegment**

**Type: Extensible      Version: 20051103**

<b>Coding Scheme Designator (0008,0102)</b>	<b>Code Value (0008,0100)</b>	<b>Code Meaning (0008,0104)</b>
SRT	R-427E6	endocardial
SRT	R-40940	epicardial

**CID 4005      Partial View Section for Mammography**

**Context ID 4005**

**Partial View Section for Mammography**

**Type: Non-Extensible      Version: 20050110**

<b>Coding Scheme Designator (0008,0102)</b>	<b>Code Value (0008,0100)</b>	<b>Code Meaning (0008,0104)</b>
SRT	R-404CC	Anterior
SRT	R-404CE	Posterior
SRT	R-42191	Superior
SRT	R-4094A	Inferior
SRT	R-404D5	Medial
SRT	G-A104	Lateral
SRT	G-A110	Central

**CID 4009      DX Anatomy Imaged**

**Context ID 4009**

**DX Anatomy Imaged**

**Type: Extensible      Version: 20040114**

<b>Coding Scheme Designator (0008,0102)</b>	<b>Code Value (0008,0100)</b>	<b>Code Meaning (0008,0104)</b>
<i>INCLUDE CID 4031 Common Anatomic Regions</i>		

**CID 4010      DX View**

**Context ID 4010**

**DX View**

**Type: Extensible      Version: 20040322**

<b>Coding Scheme Designator (0008,0102)</b>	<b>Code Value (0008,0100)</b>	<b>Code Meaning (0008,0104)</b>
---	-------------------------------	---------------------------------



SNM3	R-10202	frontal
SNM3	R-10204	frontal oblique
SNM3	R-10206	antero-posterior
SNM3	R-10208	antero-posterior oblique
SNM3	R-10210	right posterior oblique
SNM3	R-10212	left posterior oblique
SNM3	R-10214	postero-anterior
SNM3	R-10216	postero-anterior oblique
SNM3	R-10218	right anterior oblique
SNM3	R-10220	left anterior oblique
SNM3	R-10222	sagittal
SNM3	R-10224	medial-lateral
SNM3	R-40783	lateral oblique
SNM3	R-10228	lateral-medial
SNM3	R-40782	medial oblique
SNM3	R-10232	right lateral
SNM3	R-10234	right oblique
SNM3	R-10236	left lateral
SNM3	R-10238	left oblique
SNM3	R-10241	axial
SNM3	R-10242	cranio-caudal
SNM3	R-10244	caudo-cranial
SNM3	R-10246	oblique axial
SNM3	R-10248	oblique cranio-caudal
SNM3	R-10250	oblique caudo-cranial
SNM3	R-10252	frontal-oblique axial
SNM3	R-10254	sagittal-oblique axial
SNM3	R-102C1	oblique
SNM3	R-102CD	lateral
SNM3	R-102C2	tangential
SNM3	R-10256	submentovertical
SNM3	R-10257	verticosubmental
SNM3	R-102C3	plantodorsal
SNM3	R-102C4	dorsoplantar
SNM3	R-102C5	parietoacanthal
SNM3	R-102C6	acanthoparietal
SNM3	R-102C7	orbitoparietal
SNM3	R-102C8	parieto-orbital

Note: In a prior version of this Context Group, Lateral Oblique was assigned the code R-10226, and Medial Oblique was assigned the code R-10230, as synonymous with Medio-Lateral Oblique and Latero-Medial

Oblique, respectively. SNOMED currently distinguishes between LO and MLO, and between MO and LMO, although in most radiography contexts there is no practical distinction. Receiving applications should be aware that they may receive SOP Instances with the prior code assignments.

**CID 4011      DX View Modifier**

**Context ID 4011  
DX View Modifier**

**Type: Extensible Version: 20040322**

<b>Coding Scheme Designator (0008,0102)</b>	<b>Code Value (0008,0100)</b>	<b>Code Meaning (0008,0104)</b>
SNM3	R-10244	cephalad
SNM3	R-10242	caudad
SNM3	R-40885	transthoracic
SNM3	R-40799	lordotic
SNM3	R-4087B	transforaminal
SNM3	G-D00B	transoral
SNM3	R-40554	transorbital

Note: In a prior version of this Context Group, the codes R-102C9, R-102CA, R-102CB, R-102CC, and R-102CE were specified for various concepts. Those codes are not actually in SNOMED, and their use in this context is deprecated. Although there is minimal possibility of misinterpretation with SOP Instances that may include the deprecated use, receiving applications should be aware of this change; see Annex J.

CID 4012 Projection Eponymous Name

Context ID 4012  
Projection Eponymous Name  
Type: Extensible Version: 20040322

Coding Scheme Designator (0008,0102)	Code Value (0008,0100)	Code Meaning (0008,0104)
SNM3	R-10261	Albers-Schonberg
SNM3	R-10262	Alexander
SNM3	R-10263	Arcelin
SNM3	R-10264	Beclere
SNM3	R-10265	Bertel
SNM3	R-10266	Blackett-Healy
SRT	R-40809	Brewerton projection
SNM3	R-10267	Broden
SNM3	R-10268	Cahoon
SNM3	R-10269	Caldwell
SNM3	R-1026A	Camp-Coventry
SNM3	R-1026B	Causton
SNM3	R-1026C	Chamberlain
SNM3	R-1026D	Chassard-Lapine
SNM3	R-1026E	Chausse
SNM3	R-1026F	Cleaves
SNM3	R-10270	Clements
SNM3	R-10271	Clements-Nakayama
SNM3	R-10272	Dunlap
SNM3	R-10273	Ferguson
SNM3	R-10274	Fleischner
SNM3	R-10275	Friedman
SNM3	R-10276	Fuchs
SNM3	R-10277	Gaynor-Hart
SNM3	R-10278	Grandy
SNM3	R-10279	Grashey
SNM3	R-1027A	Haas
SRT	R-4080A	Harris Beath axial projection
SNM3	R-1027B	Henschen
SNM3	R-1027C	Hickey
SNM3	R-1027D	Holly
SNM3	R-1027E	Holmblad
SNM3	R-1027F	Hough
SNM3	R-10280	Hsieh

SNM3	R-10281	Hughston
SNM3	R-10282	Isherwood
SNM3	R-10283	Judd
SRT	R-4080D	Judet projection
SNM3	R-10284	Kandel
SNM3	R-10285	Kasabach
SNM3	R-10286	Kemp Harper
SNM3	R-10287	Kovacs
SNM3	R-10288	Kuchendorf
SNM3	R-10289	Kurzbauer
SNM3	R-1028A	Laquerriere-Pierquin
SNM3	R-1028B	Lauenstein
SNM3	R-1028C	Law
SNM3	R-1028D	Lawrence
SNM3	R-1028E	Leonard-George
SNM3	R-1028F	Lewis
SNM3	R-10290	Lilienfeld
SNM3	R-10291	Lindblom
SNM3	R-10292	Lorenz
SNM3	R-10293	Low-Beer
SNM3	R-10294	Lysholm
SNM3	R-10295	May
SNM3	R-10296	Mayer
SNM3	R-10297	Merchant
SNM3	R-10298	Miller
SRT	R-4080E	Mortice projection
SNM3	R-10299	Nolke
SNM3	R-1029A	Norgaard
SNM3	R-1029B	Otonello
SNM3	R-1029C	Pawlow
SNM3	R-1029D	Pearson
SNM3	R-1029E	Penner
SNM3	R-1029F	Pirie
SNM3	R-102A0	Rhese
SNM3	R-102A1	Schuller
SNM3	R-102A2	Settegast
SNM3	R-102A3	Staunig
SNM3	R-102A4	Stecher
SNM3	R-102A5	Stenvers
SNM3	R-102A6	Swanson

SNM3	R-102A7	Tarrant
SNM3	R-102A8	Taylor
SNM3	R-102A9	Teufel
SNM3	R-102AA	Titterington
SNM3	R-102AB	Towne
SNM3	R-102AC	Twining
SNM3	R-102AD	Valdini
SRT	R-40816	Van Rosen projection
SNM3	R-102AE	Waters
SNM3	R-102AF	West Point
SNM3	R-102B0	Wigby-Taylor
SNM3	R-102B1	Zanelli

**CID 4013      Anatomic Region for Mammography**

**Context ID 4013**

**Anatomic Region for Mammography**

**Type: Non-Extensible Version: 20020904**

<b>Coding Scheme Designator (0008,0102)</b>	<b>Code Value (0008,0100)</b>	<b>Code Meaning (0008,0104)</b>
SNM3	T-04000	Breast

**CID 4014 View for Mammography**

**Context ID 4014  
View for Mammography**

**Type: Non-Extensible Version: 20040322**

<b>Coding Scheme Designator (0008,0102)</b>	<b>Code Value (0008,0100)</b>	<b>Code Meaning (0008,0104)</b>	<b>ACR MQCM 1999 Equivalent</b>
SNM3	R-10224	medio-lateral	ML
SNM3	R-10226	medio-lateral oblique	MLO
SNM3	R-10228	latero-medial	LM
SNM3	R-10230	latero-medial oblique	LMO
SNM3	R-10242	cranio-caudal	CC
SNM3	R-10244	caudo-cranial (from below)	FB
SNM3	R-102D0	superolateral to inferomedial oblique	SIO
SNM3	R-102CF	exaggerated cranio-caudal	XCC
SRT	R-1024A	cranio-caudal exaggerated laterally	XCCL
SRT	R-1024B	cranio-caudal exaggerated medially	XCCM

Note: In a prior version of this Context Group, Cranio-Caudal Exaggerated Laterally was assigned the code Y-X1770, and Cranio-Caudal Exaggerated Medially was assigned the code Y-X1771. Those codes are deprecated, as they are not valid SNOMED codes. Although there is minimal possibility of misinterpretation with SOP Instances that may include the deprecated codes, receiving applications should be aware of this change; see Annex J.

**CID 4015 View Modifier for Mammography**

**Context ID 4015  
View Modifier for Mammography**

**Type: Non-Extensible Version: 20050321**

<b>Coding Scheme Designator (0008,0102)</b>	<b>Code Value (0008,0100)</b>	<b>Code Meaning (0008,0104)</b>	<b>Applies only when View ACR MQCM 1999 Equivalent (CID 4014) is:</b>	<b>ACR MQCM 1999 Equivalent</b>
SNM3	R-102D2	Cleavage	CC or FB	CV
SNM3	R-102D1	Axillary Tail	MLO	AT
SNM3	R-102D3	Rolled Lateral	any	...RL
SNM3	R-102D4	Rolled Medial	any	...RM
SRT	R-102CA	Rolled Inferior	any	...RI
SRT	R-102C9	Rolled Superior	any	...RS
SNM3	R-102D5	Implant Displaced	any	...ID
SNM3	R-102D6	Magnification	any	M...
SNM3	R-102D7	Spot Compression	any	S...
SNM3	R-102C2	Tangential	any	TAN

Note: Some applications and View Modifier ACR MQCM 1999 equivalents have been extended by DICOM to incorporate additional known clinical use cases. The View Modifier ACR MQCM 1999 equivalent indicates its use as a prefix (shown by trailing "...") or suffix (shown by preceding "...") to the View ACR MQCM 1999 equivalent, or replacement for the View ACR MQCM 1999 equivalent.

**CID 4016            Anatomic Region for Intra-oral Radiography**

**Context ID 4016  
Anatomic Region for Intra-oral Radiography  
Type: Non-Extensible Version: 20020904**

<b>Coding Scheme Designator (0008,0102)</b>	<b>Code Value (0008,0100)</b>	<b>Code Meaning (0008,0104)</b>
SNM3	T-D1213	Jaw region
SNM3	T-11170	Maxilla
SNM3	T-11180	Mandible
SNM3	T-54000	Teeth, gums and supporting structures

Note: In a prior version of this table, the code T-D1217 was specified for the concept "Maxilla and mandible". The use of this code conflicts with its assignment to another concept in SNOMED, and its use in this context is deprecated. Although there is minimal possibility of misinterpretation with SOP Instances that may include the deprecated use, receiving applications should be aware of this change; see Annex J.

**CID 4017            Anatomic Region Modifier for Intra-oral Radiography**

**Context ID 4017  
Anatomic Region Modifier for Intra-oral Radiography  
Type: Non-Extensible Version: 20020904**

<b>Coding Scheme Designator (0008,0102)</b>	<b>Code Value (0008,0100)</b>	<b>Code Meaning (0008,0104)</b>
SNM3	T-51005	Anterior 1
SNM3	T-51006	Anterior 2
SNM3	T-51007	Anterior 3
SNM3	T-51008	Premolar 1
SNM3	T-51009	Premolar 2
SNM3	T-5100A	Molar 1
SNM3	T-5100B	Molar 2
SNM3	T-5100C	Molar 3
SNM3	T-5100D	Occlusal

**CID 4018 Primary Anatomic Structure for Intra-oral Radiography (Permanent Dentition – Designation of Teeth)**

**Context ID 4018  
Primary Anatomic Structure for Intra-oral Radiography  
(Permanent Dentition - Designation of Teeth)**

**Type: Non-Extensible Version: 20020904**

<b>Coding Scheme Designator (0008,0102)</b>	<b>Code Value (0008,0100)</b>	<b>Code Meaning (0008,0104)</b>	<b>ISO 3950 Designation of Quadrant</b>	<b>ISO 3950 Designation of Tooth</b>
SNM3	T-54210	Maxillary right third molar tooth	1	8
SNM3	T-54220	Maxillary right second molar tooth	1	7
SNM3	T-54230	Maxillary right first molar tooth	1	6
SNM3	T-54240	Maxillary right second premolar tooth	1	5
SNM3	T-54250	Maxillary right first premolar tooth	1	4
SNM3	T-54260	Maxillary right canine tooth	1	3
SNM3	T-54270	Maxillary right lateral incisor tooth	1	2
SNM3	T-54280	Maxillary right central incisor tooth	1	1
SNM3	T-54290	Maxillary left central incisor tooth	2	1
SNM3	T-54300	Maxillary left lateral incisor tooth	2	2
SNM3	T-54310	Maxillary left canine tooth	2	3
SNM3	T-54320	Maxillary left first premolar tooth	2	4
SNM3	T-54330	Maxillary left second premolar tooth	2	5
SNM3	T-54340	Maxillary left first molar tooth	2	6
SNM3	T-54350	Maxillary left second molar tooth	2	7
SNM3	T-54360	Maxillary left third molar tooth	2	8
SNM3	T-54370	Mandibular left third molar tooth	3	8
SNM3	T-54380	Mandibular left second molar tooth	3	7
SNM3	T-54390	Mandibular left first molar tooth	3	6
SNM3	T-54400	Mandibular left second premolar tooth	3	5
SNM3	T-54410	Mandibular left first premolar tooth	3	4
SNM3	T-54420	Mandibular left canine tooth	3	3
SNM3	T-54430	Mandibular left lateral tooth	3	2
SNM3	T-54440	Mandibular left central incisor tooth	3	1
SNM3	T-54450	Mandibular right central incisor tooth	4	1
SNM3	T-54460	Mandibular right lateral incisor tooth	4	2
SNM3	T-54470	Mandibular right canine tooth	4	3
SNM3	T-54480	Mandibular right first premolar tooth	4	4
SNM3	T-54490	Mandibular right second premolar tooth	4	5
SNM3	T-54500	Mandibular right first molar tooth	4	6
SNM3	T-54510	Mandibular right second molar tooth	4	7
SNM3	T-54520	Mandibular right third molar tooth	4	8



**CID 4019 Primary Anatomic Structure for Intra-oral Radiography (Deciduous Dentition – Designation of Teeth)**

**Context ID 4019  
Primary Anatomic Structure for Intra-oral Radiography  
(Deciduous Dentition - Designation of Teeth)**

**Type: Non-Extensible Version: 20020904**

<b>Coding Scheme Designator (0008,0102)</b>	<b>Code Value (0008,0100)</b>	<b>Code Meaning (0008,0104)</b>	<b>ISO 3950 Designation of Quadrant</b>	<b>ISO 3950 Designation of Tooth</b>
SNM3	T-54610	Deciduous maxillary right central incisor tooth	5	1
SNM3	T-54620	Deciduous maxillary right lateral incisor tooth	5	2
SNM3	T-54630	Deciduous maxillary right canine tooth	5	3
SNM3	T-54640	Deciduous maxillary right first molar tooth	5	4
SNM3	T-54650	Deciduous maxillary right second molar tooth	5	5
SNM3	T-54660	Deciduous maxillary left central incisor tooth	6	1
SNM3	T-54670	Deciduous maxillary left lateral incisor tooth	6	2
SNM3	T-54680	Deciduous maxillary left canine tooth	6	3
SNM3	T-54690	Deciduous maxillary left first molar tooth	6	4
SNM3	T-54700	Deciduous maxillary left second molar tooth	6	5
SNM3	T-54760	Deciduous mandibular left central incisor tooth	7	1
SNM3	T-54770	Deciduous mandibular left lateral incisor tooth	7	2
SNM3	T-54780	Deciduous mandibular left canine tooth	7	3
SNM3	T-54790	Deciduous mandibular left first molar tooth	7	4
SNM3	T-54800	Deciduous mandibular left second molar tooth	7	5
SNM3	T-54710	Deciduous mandibular right central incisor tooth	8	1
SNM3	T-54720	Deciduous mandibular right lateral incisor tooth	8	2
SNM3	T-54730	Deciduous mandibular right canine tooth	8	3
SNM3	T-54740	Deciduous mandibular right first molar tooth	8	4
SNM3	T-54750	Deciduous mandibular right second molar tooth	8	5

**CID 4020 PET Radionuclide**

**Context ID 4020  
PET Radionuclide**

**Type: Extensible Version: 20020904**

<b>Coding Scheme Designator (0008,0102)</b>	<b>Code Value (0008,0100)</b>	<b>Code Meaning (0008,0104)</b>
SNM3	C-111A1	F <sup>18</sup> [ <sup>18</sup> Fluorine]
SNM3	C-159A2	Rb <sup>82</sup> [ <sup>82</sup> Rubidium]
SNM3	C-107A1	N <sup>13</sup> [ <sup>13</sup> Nitrogen]

SNM3	C-105A1	C <sup>11</sup> [Carbon]
SNM3	C-128A2	Ge <sup>68</sup> [Germanium]
SNM3	C-155A1	Na <sup>22</sup> [Sodium]

**CID 4021 PET Radiopharmaceutical**

**Context ID 4021  
PET Radiopharmaceutical**

Type: Extensible Version: 20020904

Coding Scheme Designator (0008,0102)	Code Value (0008,0100)	Code Meaning (0008,0104)
SRT	C-B1043	Acetate C <sup>11</sup>
SRT	C-B103C	Ammonia N <sup>13</sup>
SRT	C-B103B	Carbon dioxide O <sup>15</sup>
SRT	C-B1045	Carbon monoxide C <sup>11</sup>
SRT	C-B103A	Carbon monoxide O <sup>15</sup>
SRT	C-B103F	Carfentanil C <sup>11</sup>
SNM3	C-B1031	Fluorodeoxyglucose F <sup>18</sup>
SRT	C-B1034	Fluoro-L-dopa F <sup>18</sup>
SRT	C-B1046	Germanium Ge <sup>68</sup>
SRT	C-B103D	Glutamate N <sup>13</sup>
SRT	C-B103E	Methionine C <sup>11</sup>
SRT	C-B1038	Oxygen O <sup>15</sup>
SRT	C-B1039	Oxygen-water O <sup>15</sup>
SRT	C-B1044	Palmitate C <sup>11</sup>
SRT	C-B1042	Raclopride C <sup>11</sup>
SRT	C-B1037	Rubidium chloride Rb <sup>82</sup>
SNM3	C-B1032	Sodium fluoride F <sup>18</sup>
SRT	C-B1047	Sodium Na <sup>22</sup>
SRT	C-B1033	Spiperone F <sup>18</sup>
SRT	C-B1036	Thymidine (FLT)F <sup>18</sup>

**CID 4030 CT and MR Anatomy Imaged**

**Context ID 4030  
CT and MR Anatomy Imaged**

Type: Extensible Version: 20061023

Coding Scheme Designator (0008,0102)	Code Value (0008,0100)	Code Meaning (0008,0104)
<i>INCLUDE CID 4031 Common Anatomic Regions</i>		
SNM3	T-42501	Abdominal aorta
SRT	T-41070	Abdominal aorta and its branches

SNM3	T-B3000	Adrenal gland
SNM3	T-42303	Aortic arch
SNM3	T-A0100	Brain
SNM3	T-45011	Carotid
SNM3	T-A600A	Cerebellum
SNM3	T-45526	Circle of Willis
SRT	T-43000	Coronary artery
SNM3	T-A0193	Cranial venous system
SNM3	T-41040	Iliac arterial system
SNM3	T-D4909	Kidney
SNM3	T-62002	Liver
SNM3	T-D4034	Pancreas
SNM3	T-B7000	Parathyroid
SRT	T-44000	Pulmonary artery
SRT	T-46600	Renal artery
SNM3	T-D4035	Spleen
SNM3	T-9400F	Testis
SNM3	T-4600A	Thoracic aorta
SNM3	T-C8001	Thymus
SNM3	T-B6000	Thyroid
SNM3	T-83009	Uterus

**CID 4031 Common Anatomic Regions**

**Context ID 4031  
Common Anatomic Regions  
Type: Extensible Version: 20061023**

<b>Coding Scheme Designator (0008,0102)</b>	<b>Code Value (0008,0100)</b>	<b>Code Meaning (0008,0104)</b>
SNM3	T-D4000	Abdomen
SRT	R-FAB57	Abdomen and Pelvis
SNM3	T-15420	Acromioclavicular joint
SNM3	T-15750	Ankle joint
SNM3	T-280A0	Apex of Lung
SNM3	T-D8200	Arm
SNM3	T-60610	Bile duct
SNM3	T-74000	Bladder
SNM3	T-04000	Breast
SNM3	T-26000	Bronchus
SNM3	T-12770	Calcaneus
SNM3	T-11501	Cervical spine

SRT	T-D00F7	Cervico-thoracic spine
SNM3	T-D3000	Chest
SRT	R-FAB55	Chest and Abdomen
SRT	R-FAB56	Chest, Abdomen and Pelvis
SNM3	T-12310	Clavicle
SNM3	T-11BF0	Coccyx
SNM3	T-59300	Colon
SNM3	T-58200	Duodenum
SNM3	T-D8300	Elbow
SRT	T-D0010	Entire body
SRT	T-D00CC	Entire spine
SNM3	T-56000	Esophagus
SRT	T-DD163	Esophagus, stomach and duodenum
SNM3	T-D0300	Extremity
SNM3	T-11196	Facial bones
SNM3	T-12710	Femur
SNM3	T-D8800	Finger
SNM3	T-D9700	Foot
SNM3	T-12402	Forearm bone
SNM3	T-63000	Gall bladder
SNM3	T-D8700	Hand
SNM3	T-D1100	Head
SRT	T-D1000	Head and Neck
SNM3	T-32000	Heart
SNM3	T-15710	Hip joint
SNM3	T-12410	Humerus
SNM3	T-58600	Ileum
SRT	T-AB959	Internal Auditory Canal
SNM3	T-D1213	Jaw region
SNM3	T-58400	Jejunum
SNM3	T-D9200	Knee
SNM3	T-59000	Large intestine
SNM3	T-24100	Larynx
SNM3	T-D9400	Leg
SNM3	T-11503	Lumbar spine
SRT	T-D00F9	Lumbo-sacral spine
SNM3	T-11180	Mandible
SNM3	T-11133	Mastoid bone
SNM3	T-11170	Maxilla
SNM3	T-D3300	Mediastinum

SNM3	T-11149	Nasal bone
SNM3	T-D1600	Neck
SRT	R-FAB52	Neck and Chest
SRT	R-FAB53	Neck, Chest and Abdomen
SRT	R-FAB54	Neck, Chest, Abdomen and Pelvis
SNM3	T-11102	Optic canal
SNM3	T-D0801	Orbital region
SRT	T-65600	Pancreatic duct and bile duct systems
SNM3	T-22000	Paranasal sinus
SNM3	T-61100	Parotid gland
SNM3	T-12730	Patella
SNM3	T-D6000	Pelvis
SRT	R-FAB58	Pelvis and lower extremities
SRT	T-9200B	Prostate
SNM3	T-59600	Rectum
SNM3	T-11300	Rib
SNM3	T-15680	Sacroiliac joint
SNM3	T-11AD0	Sacrum
SNM3	T-12280	Scapula
SNM3	T-D1460	Sella turcica
SNM3	T-12980	Sesamoid bones of foot
SNM3	T-D2220	Shoulder
SNM3	T-11100	Skull
SNM3	T-58000	Small intestine
SNM3	T-11500	Spine
SNM3	T-15610	Sternoclavicular joint
SNM3	T-11210	Sternum
SNM3	T-57000	Stomach
SNM3	T-61300	Submandibular gland
SNM3	T-15770	Tarsal joint
SNM3	T-15290	Temporomandibular joint
SNM3	T-11502	Thoracic spine
SRT	T-D00F8	Thoraco-lumbar spine
SNM3	T-D8810	Thumb
SNM3	T-D9800	Toe
SNM3	T-25000	Trachea
SNM3	T-70010	Upper urinary tract
SRT	T-73800	Ureter
SNM3	T-75000	Urethra
SNM3	T-88920	Uterus and fallopian tubes

SRT	T-11011	Vertebral column and cranium
SNM3	T-D8600	Wrist
SNM3	T-11167	Zygomatic arch

Note: In a prior version of this table, the code T-D1217 was specified for the concept "Maxilla and mandible". The use of this code conflicts with its assignment to another concept in SNOMED, and its use in this context is deprecated. Although there is minimal possibility of misinterpretation with SOP Instances that may include the deprecated use, receiving applications should be aware of this change; see Annex J.

**CID 4032 MR Spectroscopy Metabolites**

**Context ID 4032**  
**MR Spectroscopy Metabolites**  
Type: Extensible Version: 20040322

Coding Scheme Designator (0008,0102)	Code Value (0008,0100)	Code Meaning (0008,0104)
<i>Include CID 4033 MR Proton Spectroscopy Metabolites</i>		

**CID 4033 MR Proton Spectroscopy Metabolites**

**Context ID 4033**  
**MR Proton Spectroscopy Metabolites**  
Type: Extensible Version: 20040322

Coding Scheme Designator (0008,0102)	Code Value (0008,0100)	Code Meaning (0008,0104)
SRT	F-6175A	N-acetylaspartate
SRT	F-61620	Choline
SRT	F-61380	Creatine
SRT	F-61760	Lactate
SRT	F-63600	Lipid
DCM	113080	Glutamate and glutamine
SRT	F-64210	Glutamine
SRT	F-64460	Tuarine
SRT	F-61A90	Inositol
DCM	113081	Choline/Creatine Ratio
DCM	113082	N-acetylaspartate/Creatine Ratio
DCM	113083	N-acetylaspartate/Choline Ratio

Note: For the purpose of this context group, where possible, the resonance peak in the spectrum corresponding to a particular metabolite is described using the concept from SNOMED for the substance corresponding to the metabolite. E.g. the code used for "lipid" is the code for "lipid (substance)", as this concept is effectively post-coordinated pre-coordinated by its use in the Metabolite Map Code Sequence (0018,9083) to mean "lipid resonance peaks in MR spectroscopy".

CID 4040

**Endoscopy Anatomic Regions**

**Context ID 4040  
Endoscopy Anatomic Regions**

**Type: Extensible Version: 20040326**

<b>Coding Scheme Designator (0008,0102)</b>	<b>Code Value (0008,0100)</b>	<b>Code Meaning (0008,0104)</b>
SRT	T-D4000	Abdomen
SRT	T-59490	Anus, rectum and sigmoid colon
SRT	T-60610	Bile duct
SRT	T-74000	Bladder
SRT	T-DD123	Bladder and urethra
SRT	T-26000	Bronchus
SRT	T-83200	Cervix
SRT	T-D3000	Chest
SRT	T-DD163	Esophagus, stomach and duodenum
SRT	T-AB200	External auditory canal
SRT	T-63000	Gall bladder
SRT	T-D7000	Inguinal region
SRT	T-15001	Joint
SRT	T-71000	Kidney
SRT	T-D9200	Knee
SRT	T-59000	Large intestine
SRT	T-24100	Larynx
SRT	T-40230	Lumen of blood vessel
SRT	T-D3300	Mediastinum
SRT	T-2300C	Naso pharynx
SRT	T-22000	Paranasal sinus
SRT	T-55002	Pharynx
SRT	T-20101	Pharynx and larynx
SRT	T-59600	Rectum
SRT	T-D2220	Shoulder
SRT	T-59470	Sigmoid colon
SRT	T-11500	Spine
SRT	T-DD006	Trachea and bronchus
SRT	T-70010	Upper urinary tract
SRT	T-73800	Ureter
SRT	T-88920	Uterus and fallopian tubes

Note: See Annex I for examples of the relationship between anatomic regions and type of endoscopy performed.

**CID 4042      XA/XRF Anatomy Imaged**

**Context ID 4042  
XA/XRF Anatomy Imaged**

**Type: Extensible Version: 20050822**

<b>Coding Scheme Designator (0008,0102)</b>	<b>Code Value (0008,0100)</b>	<b>Code Meaning (0008,0104)</b>
<i>INCLUDE CID 3010 Cardiovascular Anatomic Locations</i>		
<i>INCLUDE CID 4031 Common Anatomic Regions</i>		

**CID 4051      General Devices**

**Context ID 4051  
General Devices**

**Type: Extensible      Version: 20061023**

<b>Coding Scheme Designator (0008,0102)</b>	<b>Code Value (0008,0100)</b>	<b>Code Meaning (0008,0104)</b>
<i>INCLUDE CID 8 Angiographic Interventional Devices</i>		
<i>INCLUDE CID 3451 Calibration Objects</i>		
<i>INCLUDE CID 4052 Phantom Devices</i>		

**CID 4052      Phantom Devices**

**Context ID 4052  
Phantom Devices**

**Type: Extensible      Version: 20061023**

<b>Coding Scheme Designator (0008,0102)</b>	<b>Code Value (0008,0100)</b>	<b>Code Meaning (0008,0104)</b>
DCM	113681	Phantom
DCM	113682	ACR Accreditation Phantom - CT
DCM	113683	ACR Accreditation Phantom - MR
DCM	113684	ACR Accreditation Phantom - Mammography
DCM	113685	ACR Accreditation Phantom – Stereotactic Breast Biopsy
DCM	113686	ACR Accreditation Phantom - ECT
DCM	113687	ACR Accreditation Phantom - PET
DCM	113688	ACR Accreditation Phantom – ECT/PET
DCM	113689	ACR Accreditation Phantom – PET Faceplate



<b>Coding Scheme Designator (0008,0102)</b>	<b>Code Value (0008,0100)</b>	<b>Code Meaning (0008,0104)</b>
DCM	113690	IEC Head Dosimetry Phantom
DCM	113691	IEC Body Dosimetry Phantom
DCM	113692	NEMA XR21-2000 Phantom

**CID 4200      Ophthalmic Imaging Agent**

**Context ID 4200**  
**Ophthalmic Imaging Agent**  
**Type: Extensible                      Version: 20040921**

<b>Coding Scheme Designator (0008,0102)</b>	<b>Code Value (0008,0100)</b>	<b>Code Meaning (0008,0104)</b>
SRT	C-B02CC	Fluorescein
SRT	C-B0156	Indocyanine green
SRT	C-B0295	Rose Bengal
SRT	C-22853	Trypan blue
SRT	C-B02C5	Methylene blue

**CID 4201      Patient Eye Movement Command**

**Context ID 4201**  
**Patient Eye Movement Command**  
**Type: Extensible                      Version: 20040921**

<b>Coding Scheme Designator (0008,0102)</b>	<b>Code Value (0008,0100)</b>	<b>Code Meaning (0008,0104)</b>
SRT	R-1022D	Primary gaze
SRT	R-404BF	Upward gaze
SRT	R-404B9	Left upgaze
SRT	R-404BC	Left gaze
SRT	R-404B7	Left downgaze
SRT	R-404B6	Downgaze
SRT	R-404B8	Right downgaze
SRT	R-404BD	Right gaze
SRT	R-404BA	Right upgaze
SRT	R-10227	Convergent gaze

**CID 4202          Ophthalmic Photography Acquisition Device**

**Context ID 4202**  
**Ophthalmic Photography Acquisition Device**  
**Type: Extensible          Version: 20040921**

<b>Coding Scheme Designator (0008,0102)</b>	<b>Code Value (0008,0100)</b>	<b>Code Meaning (0008,0104)</b>
SRT	R-1021A	Fundus Camera
SRT	A-2B201	Biomicroscope
SRT	R-1021B	External Camera
SRT	R-1021C	Specular Microscope
SRT	A-2B210	Operating Microscope
SRT	A-00E8A	Scanning Laser Ophthalmoscope
SRT	R-1021D	Indirect Ophthalmoscope
SRT	R-1021E	Direct Ophthalmoscope
SRT	R-1021F	Ophthalmic Endoscope
SRT	A-00FCA	Keratoscope

**CID 4203          Ophthalmic Photography Illumination**

**Context ID 4203**  
**Ophthalmic Photography Illumination**  
**Type: Extensible          Version: 20040921**

<b>Coding Scheme Designator (0008,0102)</b>	<b>Code Value (0008,0100)</b>	<b>Code Meaning (0008,0104)</b>
SRT	R-1020E	Dual diffuse direct illumination
SRT	R-1020F	Fine slit beam direct illumination
SRT	R-10211	Broad tangential direct illumination
SRT	R-10213	Indirect sclerotic scatter illumination
SRT	R-10215	Indirect retroillumination from the iris
SRT	R-10217	Indirect retroillumination from the retina
SRT	R-10218	Indirect iris transillumination

Reference: From the OPS web site: <http://www.opsweb.org/Op-Photo/SlitLamp/SL/SlitLamp.htm>

**CID 4204          Ophthalmic Filter**

**Context ID 4204**  
**Ophthalmic Filter**  
**Type: Extensible          Version: 20040921**

<b>Coding Scheme Designator (0008,0102)</b>	<b>Code Value (0008,0100)</b>	<b>Code Meaning (0008,0104)</b>
DCM	111601	Green filter
DCM	111602	Red filter
DCM	111603	Blue filter
DCM	111604	Yellow-green filter
DCM	111605	Blue-green filter
DCM	111606	Infrared filter
DCM	111607	Polarizing filter
DCM	111609	No filter

**CID 4205      Ophthalmic Lens**

**Context ID 4205  
Ophthalmic Lens**

**Type: Extensible      Version: 20040921**

<b>Coding Scheme Designator (0008,0102)</b>	<b>Code Value (0008,0100)</b>	<b>Code Meaning (0008,0104)</b>
SRT	R-10219	Indirect ophthalmoscopy lens
SRT	R-10239	Concave contact fundus lens
SRT	R-1023A	Concave noncontact fundus lens
SRT	R-1023B	Contact fundus lens
SRT	A-00FAD	Goniolens
SRT	R-1023D	Convex noncontact fundus lens
SRT	R-1023E	Noncontact fundus lens
SRT	R-1023C	Convex contact fundus len

**CID 4206      Ophthalmic Channel Description**

**Context ID 4206  
Ophthalmic Channel Description**

**Type: Extensible      Version: 20040921**

<b>Coding Scheme Designator (0008,0102)</b>	<b>Code Value (0008,0100)</b>	<b>Code Meaning (0008,0104)</b>
SRT	G-A12F	Blue
SRT	R-102C0	Full Spectrum
SRT	G-A11E	Green
SRT	R-102BE	Infrared
SRT	G-A11A	Red

<b>Coding Scheme Designator (0008,0102)</b>	<b>Code Value (0008,0100)</b>	<b>Code Meaning (0008,0104)</b>
SRT	G-A132	Red free
SRT	R-102BF	Ultraviolet

**CID 4207 Ophthalmic Image Position**

**Context ID 4207**  
**Ophthalmic Image Position**  
**Type: Extensible Version: 20040921**

<b>Coding Scheme Designator (0008,0102)</b>	<b>Code Value (0008,0100)</b>	<b>Code Meaning (0008,0104)</b>
SRT	R-10229	Diabetic Retinopathy Study field 1
SRT	R-1022A	Diabetic Retinopathy Study field 2
SRT	R-1022B	Diabetic Retinopathy Study field 3
SRT	R-1022C	Diabetic Retinopathy Study field 4
SRT	R-1022E	Diabetic Retinopathy Study field 5
SRT	R-1022F	Diabetic Retinopathy Study field 6
SRT	R-10231	Diabetic Retinopathy Study field 7
DCM	111621	Field 1 for Joslin 3 field
DCM	111622	Field 2 for Joslin 3 field
DCM	111623	Field 3 for Joslin 3 field

**CID 4208 Mydriatic Agent**

**Context ID 4208**  
**Mydriatic Agent**  
**Type: Extensible Version: 20040921**

<b>Coding Scheme Designator (0008,0102)</b>	<b>Code Value (0008,0100)</b>	<b>Code Meaning (0008,0104)</b>
SRT	C-677B9	Atropine
SRT	C-677C0	Homatropine
SRT	C-97520	Cyclopentolate
SRT	C-68165	Phenylephrine
SRT	C-97580	Tropicamide

CID 4209

**Ophthalmic Anatomic Structure Imaged**

**Context ID 4209**

**Ophthalmic Anatomic Structure Imaged**

**Type: Extensible**

**Version: 20040921**

<b>Coding Scheme Designator (0008,0102)</b>	<b>Code Value (0008,0100)</b>	<b>Code Meaning (0008,0104)</b>
SRT	T-AA050	Anterior chamber of eye
SRT	T-AA180	Both eyes
SRT	T-AA310	Choroid of eye
SRT	T-AA400	Ciliary body
SRT	T-AA860	Conjunctiva
SRT	T-AA200	Cornea
SRT	T-AA000	Eye
SRT	T-AA810	Eyelid
SRT	T-AA621	Fovea centralis
SRT	T-AA500	Iris
SRT	T-AA862	Lacrimal caruncle
SRT	T-AA910	Lacrimal gland
SRT	T-AA940	Lacrimal sac
SRT	T-AA700	Lens
SRT	T-AA830	Lower Eyelid
SRT	T-45400	Ophthalmic artery
SRT	T-AA630	Optic nerve head
SRT	T-AA610	Retina
SRT	T-AA110	Sclera
SRT	T-AA820	Upper Eyelid

## **CID 5000            Languages**

Context Group ID 5000 comprises the language tag coding scheme of RFC 3066. The Coding Scheme Designator (0008,0102) shall be RFC3066.

- Notes:
1. The RFC 3066 coding scheme is constructed from a primary subtag component encoded using the language codes of ISO 639, plus two codes for extensions for languages not represented in ISO 639. The code optionally includes a second subtag component encoded using the two letter country codes of ISO 3166, or a language code extension registered by the Internet Assigned Names Authority.
  2. RFC 3066 may be obtained at <http://www.ietf.org/rfc/rfc3066.txt>. RFC 3066 obsoletes RFC 1766.
  3. ISO 639 may be obtained at <http://www.loc.gov/standards/iso639-2/langhome.html>.
  4. The two letter country codes of ISO 3166 may be obtained at <http://www.iso.ch/iso/en/prods-services/iso3166ma/02iso-3166-code-lists/index.html>
  5. IANA language tag registrations may be obtained at <http://www.iana.org/assignments/language-tags>
  6. In previous editions of the Standard, this Context Group formerly included the three letter language codes of ISO 639-2/B, using Coding Scheme Designator ISO639\_2, and several IANA-registered language code extensions, using Coding Scheme Designator IANARFC1766. RFC 3066 identifies a preference for the ISO 639-1 two letter codes to the ISO 639-2 three letter codes, and the ISO 639-2/T (terminology) subset to the ISO 639-2/B (bibliographic) subset.
  7. In previous editions of the Standard, this Context Group provided only language identifiers, with national or regional variant identified in a separate attribute or Content Item.

## **CID 5001            Countries**

Context Group ID 5001 comprises the two letter country code scheme of ISO 3166. The Coding Scheme Designator (0008,0102) shall be ISO3166\_1.

- Note:     The two letter country codes of ISO 3166 may be obtained at <http://www.iso.ch/iso/en/prods-services/iso3166ma/02iso-3166-code-lists/index.html>

**CID 6000 Overall Breast Composition**

**Context ID 6000  
Overall Breast Composition**

**Type: Extensible Version: 20020904**

Note: In future extensions, Overall Breast Composition terms that are not derived from BI-RADS® should be added to this context group.

<b>Coding Scheme Designator (0008,0102)</b>	<b>Code Value (0008,0100)</b>	<b>Code Meaning (0008,0104)</b>
<i>Include CID 6001</i>		

**CID 6001 Overall Breast Composition from BI-RADS®**

**Context ID 6001  
Overall Breast Composition from BI-RADS®**

**Type: Extensible Version: 20020904**

Note: From BI-RADS® Third Edition (National Mammography Database, E77)

<b>Coding Scheme Designator (0008,0102)</b>	<b>Code Value (0008,0100)</b>	<b>Code Meaning (0008,0104)</b>
SRT	F-01711	Almost entirely fat
SRT	F-01712	Scattered fibroglandular densities
SRT	F-01713	Heterogeneously dense
SRT	F-01714	Extremely dense

**CID 6002 Change Since Last Mammogram or Prior Surgery**

**Context ID 6002  
Change Since Last Mammogram or Prior Surgery**

**Type: Extensible Version: 20020904**

Note: In future extensions, Change Since Last Mammogram or Prior Surgery terms that are not derived from BI-RADS® should be added to this context group.

<b>Coding Scheme Designator (0008,0102)</b>	<b>Code Value (0008,0100)</b>	<b>Code Meaning (0008,0104)</b>
<i>Include CID 6003</i>		

**CID 6003 Change Since Last Mammogram or Prior Surgery from BI-RADS®**

**Context ID 6003  
Change Since Last Mammogram or Prior Surgery from BI-RADS®**

**Type: Extensible Version: 20020904**

Note: From BI-RADS® Third Edition (National Mammography Database, E79)

<b>Coding Scheme Designator (0008,0102)</b>	<b>Code Value (0008,0100)</b>	<b>Code Meaning (0008,0104)</b>
SRT	F-01721	New finding
SRT	F-01722	Finding partially removed
SRT	F-01723	No significant changes in the finding
SRT	M-02520	Increase in size
SRT	M-02530	Decrease in size
SRT	F-01726	Increase in number of calcifications
SRT	F-01727	Decrease in number of calcifications
SRT	F-01728	Less defined
SRT	F-01729	More defined
SRT	F-0172A	Removal of implant since previous mammogram
SRT	F-0172B	Implant revised since previous mammogram

**CID 6004 Mammography Characteristics of Shape**

**Context ID 6004**

**Mammography Characteristics of Shape**

**Type: Extensible Version: 20020904**

Note: In future extensions, Mammography Characteristics of Shape terms that are not derived from BI-RADS® should be added to this context group.

<b>Coding Scheme Designator (0008,0102)</b>	<b>Code Value (0008,0100)</b>	<b>Code Meaning (0008,0104)</b>
<i>Include CID 6005</i>		

**CID 6005 Characteristics of Shape from BI-RADS®**

**Context ID 6005**

**Characteristics of Shape from BI-RADS®**

**Type: Extensible Version: 20020904**

Note: From BI-RADS® Third Edition (National Mammography Database, E80)

<b>Coding Scheme Designator (0008,0102)</b>	<b>Code Value (0008,0100)</b>	<b>Code Meaning (0008,0104)</b>
SNM3	M-02100	Round shape
SNM3	M-02120	Ovoid shape (Oval)
SNM3	G-A640	Lobular
SNM3	G-A402	Irregular



**CID 6006 Mammography Characteristics of Margin**

**Context ID 6006  
Mammography Characteristics of Margin**

**Type: Extensible Version: 20020904**

Note: In future extensions, Mammography Characteristics of Margin terms that are not derived from BI-RADS® should be added to this context group.

<b>Coding Scheme Designator (0008,0102)</b>	<b>Code Value (0008,0100)</b>	<b>Code Meaning (0008,0104)</b>
<i>Include CID 6007</i>		

**CID 6007 Characteristics of Margin from BI-RADS®**

**Context ID 6007  
Characteristics of Margin from BI-RADS®**

**Type: Extensible Version: 20050822**

Note: From BI-RADS®

<b>Coding Scheme Designator (0008,0102)</b>	<b>Code Value (0008,0100)</b>	<b>Code Meaning (0008,0104)</b>
SRT	F-01741	Circumscribed lesion
SRT	F-01742	Microlobulated lesion
SRT	F-01743	Obscured lesion
SRT	F-01744	Indistinct lesion
SRT	F-01745	Spiculated lesion
DCM	111343	Angular margins

**CID 6008 Density Modifier**

**Context ID 6008  
Density Modifier**

**Type: Extensible Version: 20020904**

Note: In future extensions, Density Modifier terms that are not derived from BI-RADS® should be added to this context group.

<b>Coding Scheme Designator (0008,0102)</b>	<b>Code Value (0008,0100)</b>	<b>Code Meaning (0008,0104)</b>
<i>Include CID 6009</i>		

**CID 6009 Density Modifier from BI-RADS®**

**Context ID 6009  
Density Modifier from BI-RADS®**

**Type: Extensible Version: 20020904**

Note: From BI-RADS® Third Edition (National Mammography Database, E82)

<b>Coding Scheme Designator (0008,0102)</b>	<b>Code Value (0008,0100)</b>	<b>Code Meaning (0008,0104)</b>
SRT	F-01751	High density lesion
SRT	F-01752	Equal density (isodense) lesion
SRT	F-01753	Low density (not containing fat) lesion
SRT	F-01754	Fat containing (radiolucent) lesion

**CID 6010 Mammography Calcification Types**

**Context ID 6010  
Mammography Calcification Types  
Type: Extensible Version: 20020904**

Note: In future extensions, Mammography Calcification Types terms that are not derived from BI-RADS® should be added to this context group.

<b>Coding Scheme Designator (0008,0102)</b>	<b>Code Value (0008,0100)</b>	<b>Code Meaning (0008,0104)</b>
<i>Include CID 6011</i>		

**CID 6011 Calcification Types from BI-RADS®**

**Context ID 6011  
Calcification Types from BI-RADS®  
Type: Extensible Version: 20050822**

Note: From BI-RADS®

<b>Coding Scheme Designator (0008,0102)</b>	<b>Code Value (0008,0100)</b>	<b>Code Meaning (0008,0104)</b>
SRT	F-01761	Coarse (popcorn-like) calcification
SRT	F-01762	Dystrophic calcification
SRT	F-01763	Eggshell calcification
SRT	F-01764	Large rod-like calcification
SRT	F-01765	Milk of calcium calcification
SRT	F-01766	Lucent-centered calcification
SRT	F-01767	Punctate calcification
SRT	F-01768	Round shaped calcification
SRT	F-01769	Calcified skin of breast
SRT	F-0176A	Calcified suture material
SRT	F-0176B	Vascular calcification
SRT	F-0176C	Amorphous calcification
SRT	F-0176D	Fine, linear (casting) calcification
SRT	F-0176E	Fine linear, branching (casting) calcification

<b>Coding Scheme Designator (0008,0102)</b>	<b>Code Value (0008,0100)</b>	<b>Code Meaning (0008,0104)</b>
SRT	F-0176F	Heterogeneous calcification
DCM	111344	Fine pleomorphic calcification
SRT	D7-90435	Microcalcifications of the breast
DCM	111345	Macrocalcifications

**CID 6012 Calcification Distribution Modifier**

**Context ID 6012**  
**Calcification Distribution Modifier**  
**Type: Extensible Version: 20020904**

Note: In future extensions, Calcification Distribution Modifier terms that are not derived from BI-RADS® should be added to this context group.

<b>Coding Scheme Designator (0008,0102)</b>	<b>Code Value (0008,0100)</b>	<b>Code Meaning (0008,0104)</b>
<i>Include CID 6013</i>		

**CID 6013 Calcification Distribution Modifier from BI-RADS®**

**Context ID 6013**  
**Calcification Distribution Modifier from BI-RADS®**  
**Type: Extensible Version: 20050822**

Note: From BI-RADS®

<b>Coding Scheme Designator (0008,0102)</b>	<b>Code Value (0008,0100)</b>	<b>Code Meaning (0008,0104)</b>
SRT	F-01770	Diffuse calcification distribution
SRT	F-01771	Linear calcification distribution
SRT	F-01772	Grouped calcification distribution
SRT	F-01773	Regional calcification distribution
SRT	F-01774	Segmental calcification distribution
DCM	111346	Calcifications within a mass
DCM	111347	Calcifications outside of a mass

**CID 6014 Mammography Single Image Finding**

**Context ID 6014**  
**Mammography Single Image Finding**  
**Type: Extensible Version: 20020904**

Note: In future extensions, Mammography Single Image Finding terms that are not derived from BI-RADS® should be added to this context group.

<b>Coding Scheme Designator (0008,0102)</b>	<b>Code Value (0008,0100)</b>	<b>Code Meaning (0008,0104)</b>
<i>Include CID 6015</i>		
DCM	111099	Selected region
DCM	111100	Breast geometry
DCM	111101	Image Quality
DCM	111102	Non-lesion
SNM3	T-04100	Nipple

**CID 6015 Single Image Finding from BI-RADS®**

**Context ID 6015  
Single Image Finding from BI-RADS®**

**Type: Extensible Version: 20050822**

Note: Collected from BI-RADS®

<b>Coding Scheme Designator (0008,0102)</b>	<b>Coding Scheme Version (0008,0103)</b>	<b>Code Value (0008,0100)</b>	<b>Code Meaning (0008,0104)</b>
SRT		F-01796	Mammographic breast density
SRT		F-01776	Individual Calcification
SRT		F-01775	Calcification Cluster
SRT		F-01795	Architectural distortion of breast
SRT		F-01797	Tubular density
SRT		T-C4351	Intra-mammary lymph node
SRT		F-01798	Trabecular thickening of breast
SRT		F-01710	Breast composition
SRT		F-01799	Skin retraction of breast
SRT		F-0179A	Skin thickening of breast
BI	3.0	I.E.6	Axillary adenopathy
SNM3		D0-00050	Skin lesion
DCM		111111	Cooper's ligament changes
SRT		M-36300	Edema
DCM		111112	Mass in the skin
DCM		111113	Mass on the skin
SRT		T-C4710	Axillary lymph node

**CID 6016 Mammography Composite Feature**

**Context ID 6016  
Mammography Composite Feature**

**Type: Extensible Version: 20050110**

Note: In future extensions, Mammography Composite Feature terms that are not derived from BI-RADS® should be added to this context group.

<b>Coding Scheme Designator (0008,0102)</b>	<b>Code Value (0008,0100)</b>	<b>Code Meaning (0008,0104)</b>
DCM	111459	Mass with calcifications
<i>Include CID 6014</i>		
<i>Include CID 6017</i>		

**CID 6017 Composite Feature from BI-RADS®**

**Context ID 6017  
Composite Feature from BI-RADS®**

**Type: Extensible Version: 20020904**

Note: Collected from BI-RADS® Third Edition

<b>Coding Scheme Designator (0008,0102)</b>	<b>Code Value (0008,0100)</b>	<b>Code Meaning (0008,0104)</b>
SRT	F-01791	Mammographic breast mass
SRT	F-01792	Focal asymmetric breast tissue
SRT	F-01793	Asymmetric breast tissue

**CID 6018 Clockface Location or Region**

**Context ID 6018  
Clockface Location or Region**

**Type: Extensible Version: 20020904**

Note: In future extensions, Clockface Location or Region terms that are not derived from BI-RADS® should be added to this context group.

<b>Coding Scheme Designator (0008,0102)</b>	<b>Code Value (0008,0100)</b>	<b>Code Meaning (0008,0104)</b>
<i>Include CID 6019</i>		
SRT	T-D3050	Chest wall

**CID 6019 Clockface Location or Region from BI-RADS®**

**Context ID 6019  
Clockface Location or Region from BI-RADS®**

**Type: Extensible Version: 20020904**

Note: From BI-RADS® 3.1, with Addendum 3.1 (National Mammography Database, E96)

<b>Coding Scheme Designator (0008,0102)</b>	<b>Code Value (0008,0100)</b>	<b>Code Meaning (0008,0104)</b>
SRT	F-01781	1 o'clock position
SRT	F-01782	2 o'clock position

<b>Coding Scheme Designator (0008,0102)</b>	<b>Code Value (0008,0100)</b>	<b>Code Meaning (0008,0104)</b>
SRT	F-01783	3 o'clock position
SRT	F-01784	4 o'clock position
SRT	F-01785	5 o'clock position
SRT	F-01786	6 o'clock position
SRT	F-01787	7 o'clock position
SRT	F-01788	8 o'clock position
SRT	F-01789	9 o'clock position
SRT	F-0178A	10 o'clock position
SRT	F-0178B	11 o'clock position
SRT	F-0178C	12 o'clock position
SRT	F-0178D	Subareolar region
SRT	F-0178E	Axillary tail region
SRT	F-0178F	Central region of breast
SRT	F-01794	Axilla region

**CID 6020      Quadrant Location**

**Context ID 6020  
Quadrant Location**

**Type: Extensible Version: 20020904**

Note: In future extensions, Quadrant Location terms that are not derived from BI-RADS® should be added to this context group.

<b>Coding Scheme Designator (0008,0102)</b>	<b>Code Value (0008,0100)</b>	<b>Code Meaning (0008,0104)</b>
Include CID 6021		

**CID 6021      Quadrant Location from BI-RADS®**

**Context ID 6021  
Quadrant Location from BI-RADS®**

**Type: Extensible Version: 20020904**

Note: From BI-RADS® Third Edition (National Mammography Database, E97)

<b>Coding Scheme Designator (0008,0102)</b>	<b>Code Value (0008,0100)</b>	<b>Code Meaning (0008,0104)</b>
SRT	T-04004	Upper outer quadrant of breast
SRT	T-04002	Upper inner quadrant of breast
SRT	T-04005	Lower outer quadrant of breast
SRT	T-04003	Lower inner quadrant of breast

**CID 6022 Side**

**Context ID 6022  
Side**

**Type: Non-Extensible Version: 20020904**

Note: In future extensions, Side terms that are not derived from BI-RADS® should be added to this context group.

<b>Coding Scheme Designator (0008,0102)</b>	<b>Code Value (0008,0100)</b>	<b>Code Meaning (0008,0104)</b>
<i>Include CID 6023</i>		

**CID 6023 Side from BI-RADS®**

**Context ID 6023  
Side from BI-RADS®**

**Type: Non-Extensible Version: 20020904**

Note: From BI-RADS® Third Edition (National Mammography Database, E98)

<b>Coding Scheme Designator (0008,0102)</b>	<b>Code Value (0008,0100)</b>	<b>Code Meaning (0008,0104)</b>
SNM3	T-04030	Left breast
SNM3	T-04020	Right breast
SNM3	T-04080	Both breasts

**CID 6024 Depth**

**Context ID 6024  
Depth**

**Type: Extensible Version: 20020904**

Note: In future extensions, Depth terms that are not derived from BI-RADS® should be added to this context group.

<b>Coding Scheme Designator (0008,0102)</b>	<b>Code Value (0008,0100)</b>	<b>Code Meaning (0008,0104)</b>
<i>Include CID 6025</i>		

**CID 6025 Depth from BI-RADS®**

**Context ID 6025  
Depth from BI-RADS®**

**Type: Extensible Version: 20020904**

Note: From BI-RADS® Third Edition (National Mammography Database, E99)

<b>Coding Scheme Designator (0008,0102)</b>	<b>Code Value (0008,0100)</b>	<b>Code Meaning (0008,0104)</b>
SNM3	G-A105	Anterior
SNM3	G-A109	Middle
SNM3	G-A106	Posterior

**CID 6026 Mammography Assessment**

**Context ID 6026  
Mammography Assessment**

**Type: Extensible Version: 20050822**

Note: In future extensions, Mammography Assessment terms that are not derived from BI-RADS® should be added to this context group.

<b>Coding Scheme Designator (0008,0102)</b>	<b>Code Value (0008,0100)</b>	<b>Code Meaning (0008,0104)</b>
<i>Include CID 6027</i>		
DCM	111120	Post Procedure Mammograms for Marker Placement

**CID 6027 Assessment from BI-RADS®**

**Context ID 6027  
Assessment from BI-RADS®**

**Type: Extensible Version: 20050822**

Note: From BI-RADS®

<b>Coding Scheme Designator (0008,0102)</b>	<b>Coding Scheme Version (0008,0103)</b>	<b>Code Value (0008,0100)</b>	<b>Code Meaning (0008,0104)</b>
BI	3.0	II.AC.a	0 - Need additional imaging evaluation
BI	3.0	II.AC.b.1	1 – Negative
BI	3.0	II.AC.b.2	2 – Benign Finding
BI	3.0	II.AC.b.3	3 - Probably Benign Finding – short interval follow-up
BI	3.0	II.AC.b.4	4 - Suspicious abnormality, biopsy should be considered
BI	4.0	MA.II.A.5.4A	4A – Low suspicion
BI	4.0	MA.II.A.5.4B	4B – Intermediate suspicion
BI	4.0	MA.II.A.5.4C	4C – Moderate suspicion
BI	3.0	II.AC.b.5	5 - Highly suggestive of malignancy, take appropriate action
BI	4.0	MA.II.A.5.6	6 - Known biopsy proven malignancy



**CID 6028 Mammography Recommended Follow-up**

**Context ID 6028  
Mammography Recommended Follow-up**

**Type: Extensible Version: 20020904**

Note: In future extensions, Mammography Recommended Follow-up terms that are not derived from BI-RADS® should be added to this context group.

<b>Coding Scheme Designator (0008,0102)</b>	<b>Code Value (0008,0100)</b>	<b>Code Meaning (0008,0104)</b>
<i>Include CID 6029</i>		
DCM	111121	Follow-up post biopsy as directed by clinician
SRT	P0-006F1	Nuclear medicine procedure
SRT	P0-009B4	Evaluation procedure
DCM	111410	Surgical consult

**CID 6029 Recommended Follow-up from BI-RADS®**

**Context ID 6029  
Recommended Follow-up from BI-RADS®**

**Type: Extensible Version: 20050822**

Note: From BI-RADS®

<b>Coding Scheme Designator (0008,0102)</b>	<b>Code Value (0008,0100)</b>	<b>Code Meaning (0008,0104)</b>
DCM	111135	Additional projections
SRT	R-102D6	Magnification views
SRT	R-102D7	Spot compression
DCM	111136	Spot magnification view(s)
SRT	P5-B0099	Ultrasound procedure
DCM	111138	Old films for comparison
SRT	P5-40060	Mammary ductogram
DCM	111140	Normal interval follow-up
DCM	111141	Any decision to biopsy should be based on clinical assessment
DCM	111142	Follow-up at short interval (1-11 months)
DCM	111143	Biopsy should be considered
DCM	111144	Needle localization and biopsy
DCM	111145	Histology using core biopsy
DCM	111146	Suggestive of malignancy – take appropriate action
DCM	111147	Cytologic analysis
DCM	111148	Biopsy should be strongly considered
DCM	111149	Highly suggestive of malignancy – take appropriate action

<b>Coding Scheme Designator (0008,0102)</b>	<b>Code Value (0008,0100)</b>	<b>Code Meaning (0008,0104)</b>
DCM	111122	Known biopsy proven malignancy – take appropriate action
SRT	P5-0900D	MRI of breast

**CID 6030 Mammography Pathology Codes**

**Context ID 6030**

**Mammography Pathology Codes**

**Type: Extensible Version: 20020904**

Note: In future extensions, Mammography Pathology Codes terms that are not derived from BI-RADS® should be added to this context group.

<b>Coding Scheme Designator (0008,0102)</b>	<b>Code Value (0008,0100)</b>	<b>Code Meaning (0008,0104)</b>
<i>Include CID 6031</i>		
<i>Include CID 6032</i>		
<i>Include CID 6033</i>		

**CID 6031 Benign Pathology Codes from BI-RADS®**

**Context ID 6031**

**Benign Pathology Codes from BI-RADS®**

**Type: Extensible Version: 20020904**

Note: From BI-RADS® Third Edition, with Addendum 3.1 (National Mammography Database, F110)

<b>Coding Scheme Designator (0008,0102)</b>	<b>Code Value (0008,0100)</b>	<b>Code Meaning (0008,0104)</b>
SNM3	M-41610	Abscess
SNM3	M-74200	Adenosis
SNM3	M-81400	Adenoma
SNM3	M-83240	Adenolipoma
SNM3	M-73310	Apocrine Metaplasia
SNM3	M-89830	Adenomyoepithelioma
SNM3	M-55160	Amyloid (tumor)
DCM	111251	Normal axillary node
SNM3	M-88610	Angiolipoma
DCM	111252	Axillary node with calcifications
SNM3	M-76100	Angiomatosis
DCM	111253	Axillary node hyperplasia
SNM3	F-8A063	Asynchronous involution of breast
SNM3	D7-90360	Cyst of breast

<b>Coding Scheme Designator (0008,0102)</b>	<b>Code Value (0008,0100)</b>	<b>Code Meaning (0008,0104)</b>
DCM	111255	Benign cyst with blood
DCM	111256	Benign Calcifications
SNM3	M-92200	Chondroma
SNM3	M-85040	Intracystic papilloma
DCM	111258	Ductal adenoma
SNM3	D7-90370	Mammary duct ectasia
DCM	111259	Diabetic fibrous mastopathy
SNM3	M-72170	Ductal hyperplasia, Usual
SNM3	M-88211	Extra abdominal desmoid
SNM3	D4-48014	Ectopic (accessory) breast tissue
SNM3	M-33410	Epidermal inclusion cyst
SNM3	M-36300	Edema
SNM3	M-90100	Fibroadenoma
DCM	111263	Fibroadenomatoid hyperplasia
DCM	111264	Fibroadenolipoma
SNM3	M-44140	Foreign body (reaction)
SNM3	D7-90310	Fibrocystic disease of breast
SNM3	M-78266	Focal fibrosis
SNM3	M-78800	Fibromatosis
SNM3	D7-90434	Fat necrosis of breast
SNM3	D7-90364	Galactocele
SNM3	M-95800	Granular cell tumor
SNM3	M-90160	Giant fibroadenoma
SNM3	D7-90420	Gynecomastia
SNM3	M-75500	Hamartoma
SNM3	M-91200	Hemangioma
SNM3	D3-F0620	Hemangioma of subcutaneous tissue
SNM3	M-91220	Hemangioma – venous
SNM3	M-35060	Hematoma
SNM3	M-72000	Hyperplasia, usual
SNM3	D7-90452	Infarction of breast
SNM3	M-40000	Inflammation
SNM3	T-C4351	Intra-mammary lymph node
SNM3	M-85030	Intraductal papilloma
SNM3	M-90300	Juvenile fibroadenoma
DCM	111277	Juvenile papillomatosis
SNM3	M-82040	Lactating adenoma
SNM3	M-88500	Lipoma of the breast

<b>Coding Scheme Designator (0008,0102)</b>	<b>Code Value (0008,0100)</b>	<b>Code Meaning (0008,0104)</b>
DCM	111279	Lactational change
SNM3	D7-90428	Breast lobular hyperplasia
SNM3	M-88900	Leiomyoma
SNM3	T-C4000	Lymph node
DCM	111281	Large duct papilloma
SNM3	D3-87780	Thrombophlebitis of breast (Mondor's disease)
SNM3	M-88250	Myofibroblastoma
DCM	111284	Microglandular adenosis
DCM	111285	Multiple Intraductal Papillomas
DCM	111286	No abnormality
DCM	111287	Normal breast tissue
SNM3	M-95400	Neurofibroma
SNM3	M-95401	Neurofibromatosis
SNM3	D7-F0810	Benign neoplasm of nipple of female breast (Nipple adenoma)
DCM	111290	Oil cyst (fat necrosis cyst)
SNM3	M-80500	Papilloma
SNM3	M-89400	Pleomorphic adenoma
DCM	111291	Post reduction mammoplasty
DCM	111292	Pseudoangiomatous stromal hyperplasia
SNM3	M-78731	Radial scar
SNM3	M-74220	Sclerosing adenosis
SNM3	M-36050	Seroma
DCM	111296	Silicone granuloma
SNM3	M-78060	Scar tissue
SNM3	M-82110	Tubular adenoma
DCM	111298	Virginal hyperplasia

**CID 6032 High Risk Lesions Pathology Codes from BI-RADS®**

**Context ID 6032**

**High Risk Lesions Pathology Codes from BI-RADS®**

**Type: Extensible Version: 20020904**

Note: From BI-RADS® Third Edition, with Addendum 3.1 (National Mammography Database, F110)

<b>Coding Scheme Designator (0008,0102)</b>	<b>Code Value (0008,0100)</b>	<b>Code Meaning (0008,0104)</b>
SNM3	M-72175	Atypical intraductal hyperplasia
SNM3	M-72105	Atypical lobular hyperplasia

SNM3	D7-F0A02	Lobular carcinoma in situ of breast
DCM	111299	Peripheral duct papillomas
SNM3	M-90201	Phyllodes tumor

**CID 6033 Malignant Pathology Codes from BI-RADS®**

**Context ID 6033**

**Malignant Pathology Codes from BI-RADS®**

**Type: Extensible Version: 20020904**

Note: From BI-RADS® Third Edition, with Addendum 3.1 (National Mammography Database, F110)

<b>Coding Scheme Designator (0008,0102)</b>	<b>Code Value (0008,0100)</b>	<b>Code Meaning (0008,0104)</b>
SNM3	M-82003	Adenoid cystic carcinoma
DCM	111300	Axillary node with lymphoma
DCM	111301	Axillary nodal metastases
SNM3	M-84013	Apocrine adenocarcinoma
SNM3	M-91203	Angiosarcoma
DCM	111307	Basal cell carcinoma of nipple
DCM	111303	Blood vessel (vascular) invasion
SNM3	M-84803	Mucinous adenocarcinoma (Colloid carcinoma)
DCM	111304	Carcinoma in children
SNM3	M-92203	Chondrosarcoma
DCM	111305	Carcinoma in ectopic breast
DCM	111306	Carcinoma with endocrine differentiation
SNM3	M-85012	Comedocarcinoma (intraductal)
SNM3	D7-F0902	Carcinoma in situ of male breast
SNM3	M-85733	Carcinoma with metaplasia
DCM	111309	Cartilaginous and osseous change
DCM	111310	Carcinoma in pregnancy and lactation
SNM3	M-89803	Carcinosarcoma
DCM	111312	Intraductal comedocarcinoma with necrosis
DCM	111341	Intraductal carcinoma, high grade
DCM	111313	Intraductal carcinoma, low grade
SNM3	M-85072	Intraductal carcinoma micro-papillary
SNM3	M-88103	Fibrosarcoma
SNM3	M-83153	Glycogen-rich carcinoma
SNM3	M-91501	Hemangiopericytoma
SNM3	M-96503	Hodgkin's disease (lymphoma)
SNM3	M-82013	Invasive cribriform carcinoma
DCM	111315	Intracystic papillary carcinoma
SNM3	M-85003	Infiltrating duct carcinoma

DCM	111316	Invasive and in-situ carcinoma
SNM3	M-85203	Invasive lobular carcinoma
SNM3	M-85303	Inflammatory carcinoma
SNM3	M-80503	Papillary carcinoma (invasive)
DCM	111318	Leukemic infiltration
SNM3	M-88903	Leiomyosarcoma
SNM3	M-88503	Liposarcoma
SNM3	M-83143	Lipid-rich (lipid-secreting) carcinoma
DCM	111320	Lymphatic vessel invasion
SNM3	M-95903	Lymphoma
DCM	111322	Occult carcinoma presenting with axillary lymph node metastases
DCM	111323	Metastatic cancer to the breast
DCM	111324	Metastatic cancer to the breast from the colon
DCM	111325	Metastatic cancer to the breast from the lung
DCM	111326	Metastatic melanoma to the breast
DCM	111327	Metastatic cancer to the breast from the ovary
DCM	111328	Metastatic sarcoma to the breast
SNM3	M-85103	Medullary carcinoma
DCM	111329	Multifocal intraductal carcinoma
DCM	111330	Metastatic disease to axillary node
SNM3	M-88303	Malignant fibrous histiocytoma
DCM	111332	Multifocal invasive ductal carcinoma
DCM	111333	Metastasis to an intramammary lymph node
DCM	111334	Malignant melanoma of nipple
SNM3	M-95913	Non-Hodgkin's lymphoma
SNM3	D0-F035F	Neoplasm of the mammary skin
SNM3	M-91803	Osteogenic sarcoma
SNM3	M-80502	Papillary carcinoma in-situ
SNM3	M-85403	Paget's disease, mammary (of the nipple)
SNM3	M-97313	Plasmacytoma
SNM3	M-90203	Phyllodes tumor, malignant
DCM	111338	Recurrent malignancy
SNM3	M-84903	Signet ring cell carcinoma
DCM	111340	Squamous cell carcinoma of the nipple
SNM3	M-78190	Spindle cell nodule (tumor)
SNM3	M-85023	Secretory (juvenile) carcinoma of the breast
SNM3	M-80703	Squamous cell carcinoma
SNM3	M-82113	Tubular adenocarcinoma

**CID 6034 Intended Use of CAD Output**

**Context ID 6034  
Intended Use of CAD Output  
Type: Non-Extensible Version: 20020904**

<b>Coding Scheme Designator (0008,0102)</b>	<b>Code Value (0008,0100)</b>	<b>Code Meaning (0008,0104)</b>
DCM	111150	Presentation Required: Rendering device is expected to present
DCM	111151	Presentation Optional: Rendering device may present
DCM	111152	Not for Presentation: Rendering device expected not to present

**CID 6035 Composite Feature Relations**

**Context ID 6035  
Composite Feature Relations  
Type: Non-Extensible Version: 20020904**

<b>Coding Scheme Designator (0008,0102)</b>	<b>Code Value (0008,0100)</b>	<b>Code Meaning (0008,0104)</b>
DCM	111153	Target content items are related temporally
DCM	111154	Target content items are related spatially
DCM	111155	Target content items are related contra-laterally

**CID 6036 Scope of Feature**

**Context ID 6036  
Scope of Feature  
Type: Non-Extensible Version: 20020904**

<b>Coding Scheme Designator (0008,0102)</b>	<b>Code Value (0008,0100)</b>	<b>Code Meaning (0008,0104)</b>
DCM	111156	Feature detected on the only image
DCM	111157	Feature detected on only one of the images
DCM	111158	Feature detected on multiple images
DCM	111159	Feature detected on images from multiple modalities

**CID 6037          Mammography Quantitative Temporal Difference Type**  
**Context ID 6037**  
**Mammography Quantitative Temporal Difference Type**  
**Type: Extensible Version: 20020904**

<b>Coding Scheme Designator (0008,0102)</b>	<b>Code Value (0008,0100)</b>	<b>Code Meaning (0008,0104)</b>
SRT	F-017B1	Difference in size
SRT	F-017B2	Difference in opacity
SRT	F-017B3	Difference in location
SRT	F-017B4	Difference in spatial proximity
SRT	F-017B5	Difference in number of calcifications

**CID 6038          Mammography Qualitative Temporal Difference Type**  
**Context ID 6038**  
**Mammography Qualitative Temporal Difference Type**  
**Type: Extensible Version: 20020904**

<b>Coding Scheme Designator (0008,0102)</b>	<b>Code Value (0008,0100)</b>	<b>Code Meaning (0008,0104)</b>
SRT	F-017B6	Difference in shape
SRT	F-017B7	Difference in margin
SRT	F-017B8	Difference in symmetry

**CID 6039          Nipple Characteristic**  
**Context ID 6039**  
**Nipple Characteristic**  
**Type: Extensible Version: 20020904**

<b>Coding Scheme Designator (0008,0102)</b>	<b>Code Value (0008,0100)</b>	<b>Code Meaning (0008,0104)</b>
SNM3	M-02000	Normal shape
SNM3	D7-90554	Nipple retraction



**CID 6040 Non-Lesion Object Type**

**Context ID 6040  
Non-Lesion Object Type  
Type: Extensible Version: 20020904**

<b>Coding Scheme Designator (0008,0102)</b>	<b>Code Value (0008,0100)</b>	<b>Code Meaning (0008,0104)</b>
SNM3	A-04010	Implant
SNM3	M-78060	Scar tissue
SNM3	A-32475	BB shot (Lead Pellet)
SNM3	J-83250	Metal (Lead) Marker
SNM3	A-32110	Bullet
SNM3	A-1016B	J Wire
SNM3	A-13600	Staple
SNM3	A-13510	Suture material
SNM3	A-12062	Clip
SNM3	A-11101	Pacemaker
SNM3	A-26800	Catheter
SNM3	A-10042	Compression paddle
SNM3	A-10044	Collimator
SNM3	A-16016	ID Plate
SNM3	C-B0300	Contrast agent
DCM	111175	Other Marker
DCM	111176	Unspecified

**CID 6041 Mammography Image Quality Finding**

**Context ID 6041  
Mammography Image Quality Finding  
Type: Extensible Version: 20020904**

<b>Coding Scheme Designator (0008,0102)</b>	<b>Code Value (0008,0100)</b>	<b>Code Meaning (0008,0104)</b>	<b>Source</b>
DCM	111177	View and Laterality Marker is missing	MQSA
DCM	111178	View and Laterality Marker does not have both view and laterality	MQCM 1999
DCM	111179	View and Laterality Marker does not have approved codes	MQCM 1999
DCM	111180	View and Laterality Marker is not near the axilla	MQCM 1999
DCM	111181	View and Laterality Marker overlaps	MQCM 1999

<b>Coding Scheme Designator (0008,0102)</b>	<b>Code Value (0008,0100)</b>	<b>Code Meaning (0008,0104)</b>	<b>Source</b>
		breast tissue	
DCM	111182	View and Laterality Marker is partially obscured	MQCM 1999
DCM	111183	View and Laterality Marker is incorrect	
DCM	111184	View and Laterality Marker is off image	
DCM	111185	Flash is not near edge of film	MQCM 1999
DCM	111186	Flash is illegible, does not fit, or is lopsided	MQSA
DCM	111187	Flash doesn't include patient name and additional patient id	MQCM 1999
DCM	111188	Flash doesn't include date of examination	MQCM 1999
DCM	111189	Flash doesn't include facility name and location	MQSA
DCM	111190	Flash doesn't include technologist identification	MQCM 1999
DCM	111191	Flash doesn't include cassette/screen/detector identification	MQCM 1999
DCM	111192	Flash doesn't include mammography unit identification	MQCM 1999
DCM	111193	Date sticker is missing	MQCM 1999
DCM	111194	Technical factors missing	MQCM 1999
DCM	111195	Collimation too close to breast	MQCM 1999
DCM	111196	Inadequate compression	MQCM 1999
DCM	111197	MLO Insufficient pectoral muscle	MQCM 1999
DCM	111198	MLO No fat is visualized posterior to fibroglandular tissues	MQCM 1999
DCM	111199	MLO Poor separation of deep and superficial breast tissues	MQCM 1999
DCM	111200	MLO Evidence of motion blur	MQCM 1999
DCM	111201	MLO Inframammary fold is not open	MQCM 1999
DCM	111202	CC Not all medial tissue visualized	MQCM 1999
DCM	111203	CC Nipple not centered on image	MQCM 1999
DCM	111204	CC Posterior nipple line does not measure within 1 cm of MLO	MQCM 1999
DCM	111205	Nipple not in profile	
DCM	111206	Insufficient implant displacement incorrect	MQCM 1999
DCM	111208	Grid artifact(s)	
DCM	111209	Positioning	

<b>Coding Scheme Designator (0008,0102)</b>	<b>Code Value (0008,0100)</b>	<b>Code Meaning (0008,0104)</b>	<b>Source</b>
DCM	111210	Motion blur	
DCM	111211	Under exposed	
DCM	111212	Over exposed	
DCM	111213	No image	
DCM	111214	Detector artifact(s)	
DCM	111215	Artifact(s) other than grid or detector artifact	
DCM	111216	Mechanical failure	
DCM	111217	Electrical failure	
DCM	111218	Software failure	
DCM	111219	Inappropriate image processing	
DCM	111220	Other failure	
DCM	111221	Unknown failure	

**CID 6042 Status of Results**

**Context ID 6042  
Status of Results**

**Type: Non-Extensible Version: 20020904**

<b>Coding Scheme Designator (0008,0102)</b>	<b>Code Value (0008,0100)</b>	<b>Code Meaning (0008,0104)</b>
DCM	111222	Succeeded
DCM	111223	Partially Succeeded
DCM	111224	Failed
DCM	111225	Not Attempted

**CID 6043 Types of Mammography CAD Analysis**

**Context ID 6043  
Types of Mammography CAD Analysis**

**Type: Extensible Version: 20020904**

<b>Coding Scheme Designator (0008,0102)</b>	<b>Code Value (0008,0100)</b>	<b>Code Meaning (0008,0104)</b>	
SRT	P5-B3402	Spatial collocation analysis	See Note 1
SRT	P5-B3404	Spatial proximity analysis	See Note 2
SRT	P5-B3406	Temporal correlation	

<b>Coding Scheme Designator (0008,0102)</b>	<b>Code Value (0008,0100)</b>	<b>Code Meaning (0008,0104)</b>	
SRT	P5-B3408	Image quality analysis	
SRT	P5-B3410	Focal asymmetric density analysis	
SRT	P5-B3412	Asymmetric breast tissue analysis	
SRT	P5-B3414	Breast composition analysis	
DCM	111233	Individual Impression / Recommendation Analysis	
DCM	111234	Overall Impression / Recommendation Analysis	

- Notes:
1. Spatial Collocation Analysis is used to identify features that are the same or located in the same place.
  2. Spatial Proximity Analysis is used to identify features that are related spatially, such as nipple retraction associated with a spiculated mass.

**CID 6044      Types of Image Quality Assessment**

**Context ID 6044**  
**Types of Image Quality Assessment**  
**Type: Extensible Version: 20020904**

<b>Coding Scheme Designator (0008,0102)</b>	<b>Code Value (0008,0100)</b>	<b>Code Meaning (0008,0104)</b>
DCM	111235	Unusable — Quality renders image unusable
DCM	111236	Usable — Does not meet the quality control standard
DCM	111237	Usable — Meets the quality control standard

**CID 6045      Mammography Types of Quality Control Standard**

**Context ID 6045**  
**Mammography Types of Quality Control Standard**  
**Type: Extensible Version: 20020904**

<b>Coding Scheme Designator (0008,0102)</b>	<b>Code Value (0008,0100)</b>	<b>Code Meaning (0008,0104)</b>
DCM	111238	Mammography Quality Control Manual 1999, ACR
DCM	111239	Title 21 CFR Section 900, Subpart B
DCM	111240	Institutionally defined quality control standard

**CID 6046      Units of Follow-up Interval**

**Context ID 6046**  
**Units of Follow-up Interval**  
**Type: Extensible Version: 20020904**

<b>Coding Scheme Designator (0008,0102)</b>	<b>Coding Scheme Version (0008,0103)</b>	<b>Code Value (0008,0100)</b>	<b>Code Meaning (0008,0104)</b>
UCUM	1.4	d	Day
UCUM	1.4	wk	Week
UCUM	1.4	mo	Month
UCUM	1.4	a	Year

**CID 6047      CAD Processing and Findings Summary**

**Context ID 6047**  
**CAD Processing and Findings Summary**  
**Type: Non-Extensible Version: 20020904**

<b>Coding Scheme Designator (0008,0102)</b>	<b>Code Value (0008,0100)</b>	<b>Code Meaning (0008,0104)</b>
DCM	111241	All algorithms succeeded; without findings
DCM	111242	All algorithms succeeded; with findings
DCM	111243	Not all algorithms succeeded; without findings
DCM	111244	Not all algorithms succeeded; with findings
DCM	111245	No algorithms succeeded; without findings

**CID 6048      CAD Operating Point Axis Label**

**Context ID 6048**  
**CAD Operating Point Axis Label**  
**Type: Extensible      Version: 20060612**

<b>Coding Scheme Designator (0008,0102)</b>	<b>Code Value (0008,0100)</b>	<b>Code Meaning (0008,0104)</b>
DCM	111023	Certainty of Finding
DCM	111047	Probability of cancer
DCM	111086	False Markers per Image
DCM	111087	False Markers per Case
DCM	111088	Case Sensitivity
DCM	111089	Lesion Sensitivity
DCM	111090	Case Specificity

<b>Coding Scheme Designator (0008,0102)</b>	<b>Code Value (0008,0100)</b>	<b>Code Meaning (0008,0104)</b>
DCM	111091	Image Specificity

**CID 6050 Breast Procedure Reported**

**Context ID 6050**

**Breast Procedure Reported**

**Type: Extensible Version: 20050822**

<b>Coding Scheme Designator (0008,0102)</b>	<b>Code Value (0008,0100)</b>	<b>Code Meaning (0008,0104)</b>
DCM	111408	Film Screen Mammography
DCM	111409	Digital Mammography
SRT	P5-B8500	Ultrasonography of breast
SRT	P5-0900D	MRI of breast
SRT	P1-48011	Pre-biopsy localization of breast lesion
SRT	P1-48145	Fine needle aspiration of breast
SRT	P1-48142	Diagnostic aspiration of breast cyst
SRT	P1-48304	Core needle biopsy of breast
SRT	P1-4830F	Breast – surgical biopsy
SRT	P5-40060	Mammary ductogram
SRT	P5-0801C	CT of breast
SRT	P5-D0042	Radionuclide localization of tumor, limited area
SRT	P5-40030	Specimen radiography of breast
SRT	P2-4A000	Examination of breast
DCM	111410	Surgical consult
DCM	111411	Mammography CAD
SRT	P1-65359	Sentinel lymph node biopsy
SRT	P5-D0061	Radioisotope scan of lymphatic system
DCM	111123	Clip placement
SRT	P1-05535	Insertion of catheter

**CID 6051 Breast Procedure Reason**

**Context ID 6051**

**Breast Procedure Reason**

**Type: Extensible Version: 20050822**

Note: Some of these terms were obtained from BI-RADS®

<b>Coding Scheme Designator (0008,0102)</b>	<b>Code Value (0008,0100)</b>	<b>Code Meaning (0008,0104)</b>
<i>Include CID 6061</i>		
DCM	111415	Additional evaluation requested from prior study
DCM	111416	Follow-up at short interval from prior study
DCM	111417	History of breast augmentation, asymptomatic
DCM	111418	Review of an outside study
DCM	111402	Clinical finding
SRT	P1-48830	Reduction mammoplasty
SRT	P5-C0000	Radiation therapy
SRT	P1-48840	Augmentation mammoplasty
DCM	111419	Additional evaluation requested from abnormal screening exam
SRT	P5-C0610	Brachytherapy
DCM	111420	History of benign breast biopsy
DCM	111421	Personal history of breast cancer with breast conservation therapy
DCM	111124	Personal history of breast cancer with mastectomy
DCM	111125	Known biopsy proven malignancy
SRT	G-03D3	Personal history of breast cancer

**CID 6052 Breast Imaging Report section title**

**Context ID 6052**

**Breast Imaging Report Section Title**

**Type: Extensible Version: 20040112**

<b>Coding Scheme Designator (0008,0102)</b>	<b>Code Value (0008,0100)</b>	<b>Code Meaning (0008,0104)</b>
DCM	111423	Physical Examination Results
DCM	111424	Comparison to previous exams
DCM	121070	Findings
DCM	121072	Impressions
DCM	121074	Recommendations
DCM	121076	Conclusions
DCM	121078	Addendum
SRT	F-01710	Breast composition
DCM	111413	Overall Assessment
DCM	121058	Procedure reported
DCM	111401	Reason for procedure

**CID 6053 Breast Imaging Report Elements**

**Context ID 6053**

**Breast Imaging Report Elements**

**Type: Extensible Version: 20040112**

<b>Coding Scheme Designator (0008,0102)</b>	<b>Code Value (0008,0100)</b>	<b>Code Meaning (0008,0104)</b>
DCM	111423	Physical Examination Results
DCM	111424	Comparison to previous exams
DCM	121071	Finding
DCM	121073	Impression
DCM	121075	Recommendation
DCM	121077	Conclusion
SRT	F-01710	Breast composition
DCM	111413	Overall Assessment
DCM	121058	Procedure reported
DCM	111401	Reason for procedure

**CID 6054 Breast Imaging Findings**

**Context ID 6054**

**Breast Imaging Findings**

**Type: Extensible Version: 20050110**

<b>Coding Scheme Designator (0008,0102)</b>	<b>Code Value (0008,0100)</b>	<b>Code Meaning (0008,0104)</b>
SRT	F-8A084	Breast normal
SRT	F-8A057	Calcification of breast
SRT	A-04010	Implant
<i>Include CID 6016</i>		
<i>Include CID 6057</i>		
<i>Include CID 6064</i>		

**CID 6055 Breast Clinical Finding or Indicated Problem**

**Context ID 6055**

**Breast Clinical Finding or Indicated Problem**

**Type: Extensible Version: 20050822**

Note: Some of these terms were obtained from BI-RADS®



<b>Coding Scheme Designator (0008,0102)</b>	<b>Code Value (0008,0100)</b>	<b>Code Meaning (0008,0104)</b>
SRT	R-207D7	O/E - Breast lump palpated
SRT	D7-90565	Bloody nipple discharge
DCM	111478	Non-bloody discharge (from nipple)
DCM	111479	Difficult physical/clinical examination
SRT	D7-90010	Disorder of breast implant
SRT	F-0179A	Skin thickening of breast
SRT	F-01799	Skin retraction of breast
SRT	D7-90560	Peau d'orange surface of breast
SRT	F-8A09C	Nipple problem
SRT	R-20099	O/E – axillary lymphadenopathy
SRT	F-8A030	Breast pain
DCM	111480	Cancer elsewhere
SRT	D7-90530	Breast lump
SRT	F-8A074	Discoloration of skin of breast
SRT	F-01760	Radiographic calcification finding
DCM	111126	Image detected mass

**CID 6056 Associated Findings for Breast**

**Context ID 6056**

**Associated Findings for Breast**

**Type: Extensible Version: 20040112**

Note: These terms were obtained from BI-RADS®

<b>Coding Scheme Designator (0008,0102)</b>	<b>Code Value (0008,0100)</b>	<b>Code Meaning (0008,0104)</b>
SRT	D7-9002A	Breast hematoma
SRT	M-78280	Surgical scar
SRT	D7-90554	Nipple retraction
<i>Include CID 6015</i>		

**CID 6057 Ductography Findings for Breast**

**Context ID 6057**

**Ductography Findings for Breast**

**Type: Extensible Version: 20040112**

Note: These terms were obtained from BI-RADS®

<b>Coding Scheme Designator (0008,0102)</b>	<b>Code Value (0008,0100)</b>	<b>Code Meaning (0008,0104)</b>
DCM	111287	Normal breast tissue
DCM	111425	Intraluminal filling defect
SRT	D7-90370	Mammary duct ectasia
DCM	111426	Multiple filling defect
DCM	111427	Abrupt duct termination
DCM	111428	Extravasation
DCM	111429	Duct narrowing
DCM	111430	Cyst fill

**CID 6058 Procedure Modifiers for Breast**

**Context ID 6058**

**Procedure Modifiers for Breast**

**Type: Extensible Version: 20050822**

<b>Coding Scheme Designator (0008,0102)</b>	<b>Code Value (0008,0100)</b>	<b>Code Meaning (0008,0104)</b>
<i>Include CID 6059</i>		
<i>Include CID 6060</i>		
<i>Include CID 6061</i>		
<i>Include CID 12224</i>		

**CID 6059 Breast Implant Types**

**Context ID 6059**

**Breast Implant Types**

**Type: Extensible Version: 20040112**

Note: Some of these terms were obtained from BI-RADS®

<b>Coding Scheme Designator (0008,0102)</b>	<b>Code Value (0008,0100)</b>	<b>Code Meaning (0008,0104)</b>
SRT	A-04830	Breast implant, type not specified
SRT	A-04831	Silicone gel implant
DCM	111481	Saline implant
DCM	111482	Polyurethane implant
DCM	111483	Percutaneous silicone injection
DCM	111484	Combination implant
DCM	111485	Pre-pectoral implant
DCM	111486	Retro-pectoral implant

**CID 6060 Breast Biopsy Techniques**

**Context ID 6060**

**Breast Biopsy Techniques**

**Type: Extensible Version: 20050822**

Note: Some of these terms were obtained from BI-RADS®

<b>Coding Scheme Designator (0008,0102)</b>	<b>Code Value (0008,0100)</b>	<b>Code Meaning (0008,0104)</b>
SRT	P1-03005	Lumpectomy
SRT	P1-43850	Mastectomy
SRT	P1-4834A	Quadrantectomy of breast
SRT	P5-00032	Diagnostic radiography, stereotactic localization
SRT	P5-B0700	Ultrasonic guidance procedure
SRT	P5-40010	Mammography
DCM	111487	Mammographic (crosshair)
DCM	111488	Mammographic (grid)
SRT	P1-03107	Magnetic resonance imaging guided biopsy
SRT	P1-03106	Computed tomography guided biopsy
DCM	111489	Palpation guided
DCM	111490	Vacuum assisted

Note: In a prior version of this Context Group, the code P1-03115 was specified for the concept "Ultrasound guided biopsy". The use of this code is too restrictive, and its use in this context is deprecated. There is minimal possibility of misinterpretation with SOP Instances that may include the deprecated use.

**CID 6061 Breast Imaging Procedure Modifiers**

**Context ID 6061**

**Breast Imaging Procedure Modifiers**

**Type: Extensible Version: 20050822**

<b>Coding Scheme Designator (0008,0102)</b>	<b>Code Value (0008,0100)</b>	<b>Code Meaning (0008,0104)</b>
SRT	R-42453	Screening
SRT	R-408C3	Diagnostic
DCM	111127	Targeted
DCM	111128	Survey

**CID 6062            Interventional Procedure Complications**

**Context ID 6062**

**Interventional Procedure Complications**

**Type: Extensible            Version: 20040112**

<b>Coding Scheme Designator (0008,0102)</b>	<b>Code Value (0008,0100)</b>	<b>Code Meaning (0008,0104)</b>
SRT	DD-66A67	Hemorrhage postprocedure
DCM	111491	Abnormal discharge
SRT	F-0147C	Hematoma - postoperative
SRT	D0-00165	Weal
SRT	DD-67700	Infection as complication of medical care
SRT	F-A2632	Persistent pain following procedure
SRT	D2-80300	Pneumothorax
SRT	D0-00058	Rash
SRT	M-02570	Swelling
SRT	F-A5581	Vasovagal attack
DCM	111492	No complications

**CID 6063            Interventional Procedure Results**

**Context ID 6063**

**Interventional Procedure Results**

**Type: Extensible            Version: 20040112**

<b>Coding Scheme Designator (0008,0102)</b>	<b>Code Value (0008,0100)</b>	<b>Code Meaning (0008,0104)</b>
SRT	G-A249	Benign
SRT	R-41DDC	High risk tumor
SRT	G-A245	Malignant
SRT	M-09024	Insufficient sample
SRT	F-01E06	Indeterminate result

**CID 6064      Ultrasound Findings for Breast**

**Context ID 6064**

**Ultrasound Findings for Breast**

**Type: Extensible      Version: 20050822**

Note: These terms were obtained from BI-RADS®

<b>Coding Scheme Designator (0008,0102)</b>	<b>Code Value (0008,0100)</b>	<b>Code Meaning (0008,0104)</b>
SRT	F-01BF8	Ultrasound scan normal
SRT	D7-90360	Simple cyst of breast
DCM	111460	Complex cyst
DCM	111461	Intracystic lesion
SRT	D7-90370	Mammary duct ectasia
DCM	111462	Solid mass
SRT	T-C4000	Lymph node
SRT	D7-90382	Sebaceous cyst of skin of breast
DCM	111129	Clustered microcysts
DCM	111130	Complicated cyst
SRT	M-30400	Foreign body

**CID 6065      Instrument Approach**

**Context ID 6065**

**Instrument Approach**

**Type: Extensible      Version: 20040112**

<b>Coding Scheme Designator (0008,0102)</b>	<b>Code Value (0008,0100)</b>	<b>Code Meaning (0008,0104)</b>
SRT	G-A109	Medial
SRT	G-A104	Lateral
SRT	G-A116	Superior
SRT	G-A115	Inferior
DCM	111432	Inferolateral to superomedial
DCM	111433	Inferomedial to superolateral
DCM	111434	Superolateral to inferomedial
DCM	111435	Superomedial to inferolateral

**CID 6066 Target Confirmation**

**Context ID 6066  
Target Confirmation**

**Type: Extensible Version: 20040112**

<b>Coding Scheme Designator (0008,0102)</b>	<b>Code Value (0008,0100)</b>	<b>Code Meaning (0008,0104)</b>
DCM	111443	Target contained in the specimen
DCM	111444	Target partially obtained in the specimen
DCM	111445	Target not in the specimen
DCM	111446	Calcifications seen in the core
DCM	111447	Lesion completely removed
DCM	111448	Lesion partially removed
DCM	111449	Fluid obtained

**CID 6067 Fluid Color**

**Context ID 6067  
Fluid Color**

**Type: Extensible Version: 20040112**

<b>Coding Scheme Designator (0008,0102)</b>	<b>Code Value (0008,0100)</b>	<b>Code Meaning (0008,0104)</b>
SRT	G-A12B	White color
SRT	G-A11D	Yellow color
DCM	111450	Light brown color
SRT	G-A11E	Green color
SRT	G-A12D	Gray color
DCM	111451	Dark red color
DCM	111452	Dark brown color
SRT	R-4205B	Clear
SRT	G-A12E	Brown color
DCM	111453	Bright red color
DCM	111454	Blood tinged color
SRT	G-A12C	Black color

**CID 6068 Tumor Stages from AJCC**

**Context ID 6068**

**Tumor Stages from AJCC**

**Type: Extensible Version: 20040112**

<b>Coding Scheme Designator (0008,0102)</b>	<b>Code Value (0008,0100)</b>	<b>Code Meaning (0008,0104)</b>
DCM	111494	Stage 0
DCM	111495	Stage I
DCM	111496	Stage IIA
DCM	111497	Stage IIB
DCM	111498	Stage IIIA
DCM	111499	Stage IIIB
DCM	111500	Stage IIIC
DCM	111501	Stage IV

**CID 6069 Nottingham Combined Histologic Grade**

**Context ID 6069**

**Nottingham Combined Histologic Grade**

**Type: Extensible Version: 20040112**

<b>Coding Scheme Designator (0008,0102)</b>	<b>Code Value (0008,0100)</b>	<b>Code Meaning (0008,0104)</b>
SRT	F-02B9B	Nottingham Combined Grade cannot be determined
SRT	G-F616	Nottingham Combined Grade I: 3-5 points
SRT	G-F617	Nottingham Combined Grade II: 6-7 points
SRT	G-F618	Nottingham Combined Grade III: 8-9 points

**CID 6070 Bloom-Richardson Histologic Grade**

**Context ID 6070**

**Bloom-Richardson Histologic Grade**

**Type: Extensible Version: 20040112**

<b>Coding Scheme Designator (0008,0102)</b>	<b>Code Value (0008,0100)</b>	<b>Code Meaning (0008,0104)</b>
SRT	G-F211	Grade 1: well differentiated
SRT	G-F212	Grade 2: moderately differentiated
SRT	G-F213	Grade 3: poorly differentiated
SRT	R-41DC5	Grade 4: undifferentiated

**CID 6071          Histologic Grading Method**

**Context ID 6071**

**Histologic Grading Method**

**Type: Extensible          Version: 20040112**

<b>Coding Scheme Designator (0008,0102)</b>	<b>Code Value (0008,0100)</b>	<b>Code Meaning (0008,0104)</b>
DCM	111502	Bloom-Richardson Grade
SRT	R-00288	Nottingham Combined Grade

**CID 6072          Breast Implant Findings**

**Context ID 6072**

**Breast Implant Findings**

**Type: Extensible          Version: 20040112**

Note: These terms were obtained from BI-RADS®

<b>Coding Scheme Designator (0008,0102)</b>	<b>Code Value (0008,0100)</b>	<b>Code Meaning (0008,0104)</b>
DCM	111503	Normal implants
DCM	111504	Asymmetric implants
DCM	111505	Calcified implant
DCM	111506	Distorted implant
DCM	111507	Silicone-laden lymph nodes
DCM	111508	Free silicone
DCM	111509	Herniated implant
SRT	DD-66544	Rupture of breast implant
DCM	111510	Explantation

**CID 6080          Gynecological Hormones**

**Context ID 6080**

**Gynecological Hormones**

**Type: Extensible          Version: 20050822**

Note: Some of these terms were obtained from BI-RADS®

<b>Coding Scheme Designator (0008,0102)</b>	<b>Code Value (0008,0100)</b>	<b>Code Meaning (0008,0104)</b>
SRT	C-B1700	Contraceptives
SRT	C-A0900	Estrogen product



<b>Coding Scheme Designator (0008,0102)</b>	<b>Code Value (0008,0100)</b>	<b>Code Meaning (0008,0104)</b>
SRT	C-A1204	Progesterone product
SRT	C-781E0	Tamoxifen
DCM	111542	Unspecified gynecological hormone
SRT	C-A0005	Raloxifene
SRT	F-61B21	Anastrozole

**CID 6081 Breast Cancer Risk Factors**

**Context ID 6081**

**Breast Cancer Risk Factors**

**Type: Extensible Version: 20040112**

Note: Some of these terms were obtained from BI-RADS®

<b>Coding Scheme Designator (0008,0102)</b>	<b>Code Value (0008,0100)</b>	<b>Code Meaning (0008,0104)</b>
DCM	111550	Personal breast cancer history
DCM	111551	History of endometrial cancer
DCM	111552	History of ovarian cancer
DCM	111553	History of high risk lesion on previous biopsy
DCM	111554	Post menopausal patient
SRT	F-84430	Nulliparous
DCM	111555	Late child bearing (after 30)
DCM	111556	BRCA1 breast cancer gene
DCM	111557	BRCA2 breast cancer gene
DCM	111558	BRCA3 breast cancer gene
SRT	G-0325	Family history of breast cancer
DCM	111559	Weak family history of breast cancer
DCM	111560	Intermediate family history of breast cancer
DCM	111561	Very strong family history of breast cancer
DCM	111562	Family history of prostate cancer
DCM	111563	Family history unknown
SRT	R-207AD	No family history of breast carcinoma

**CID 6082          Gynecological Procedures**

**Context ID 6082**

**Gynecological Procedures**

**Type: Extensible          Version: 20040112**

<b>Coding Scheme Designator (0008,0102)</b>	<b>Code Value (0008,0100)</b>	<b>Code Meaning (0008,0104)</b>
SRT	P0-05CCA	Endometrial biopsy
SRT	P1-8330D	Hysterectomy
SRT	P1-03151	Dilation and curettage

**CID 6083          Procedures for Breast**

**Context ID 6083**

**Procedures for Breast**

**Type: Extensible          Version: 20040112**

<b>Coding Scheme Designator (0008,0102)</b>	<b>Code Value (0008,0100)</b>	<b>Code Meaning (0008,0104)</b>
DCM	111564	Nipple discharge cytology
<i>Include CID 6050</i>		
<i>Include CID 6084</i>		
<i>Include CID 6085</i>		

**CID 6084          Mammoplasty Procedures**

**Context ID 6084**

**Mammoplasty Procedures**

**Type: Extensible          Version: 20040112**

<b>Coding Scheme Designator (0008,0102)</b>	<b>Code Value (0008,0100)</b>	<b>Code Meaning (0008,0104)</b>
SRT	P1-48501	Breast implantation
SRT	P1-48830	Reduction mammoplasty
SRT	P1-48820	Breast reconstruction
SRT	P1-48520	Removal of breast implant

**CID 6085 Therapies for Breast**

**Context ID 6085**

**Therapies for Breast**

**Type: Extensible Version: 20040112**

<b>Coding Scheme Designator (0008,0102)</b>	<b>Code Value (0008,0100)</b>	<b>Code Meaning (0008,0104)</b>
SRT	P0-0058E	Chemotherapy
SRT	P5-C0000	Radiation therapy
SRT	P0-007AC	Hormone therapy
SRT	P1-67D40	Bone marrow transplant

**CID 6086 Menopausal Phase**

**Context ID 6086**

**Menopausal Phase**

**Type: Extensible Version: 20040112**

<b>Coding Scheme Designator (0008,0102)</b>	<b>Code Value (0008,0100)</b>	<b>Code Meaning (0008,0104)</b>
SRT	R-41FFF	Before menopause
SRT	R-422A5	During menopause
SRT	R-410C3	After menopause
SRT	D7-76202	Postsurgical menopause
SRT	D7-76200	Artificial menopause state

**CID 6087 General Risk Factors**

**Context ID 6087**

**General Risk Factors**

**Type: Extensible Version: 20040112**

This context group collects risk factor terms from specialized risk factor context groups into one aggregate list for general purpose use.

<b>Coding Scheme Designator (0008,0102)</b>	<b>Code Value (0008,0100)</b>	<b>Code Meaning (0008,0104)</b>
<i>Include CID 6081</i>		
<i>Include CID 6088</i>		

**CID 6088 OB-GYN Maternal Risk Factors**

**Context ID 6088**

**OB-GYN Maternal Risk Factors**

**Type: Extensible Version: 20040112**

<b>Coding Scheme Designator (0008,0102)</b>	<b>Code Value (0008,0100)</b>	<b>Code Meaning (0008,0104)</b>
SRT	G-023F	History of – diabetes mellitus
SRT	G-0269	History of - hypertension
SRT	G-0244	History of - obesity
SRT	G-02D0	History of – regular medication
SRT	G-0338	History of substance abuse
SRT	G-0335	History of – cardiovascular disease
DCM	111565	Uterine malformations
SRT	G-0304	History of - ectopic pregnancy
DCM	111566	Spontaneous Abortion
DCM	111567	Gynecologic condition
DCM	111568	Gynecologic surgery
SRT	G-031E	History of - eclampsia
SRT	G-031F	History of – severe pre-eclampsia
DCM	111569	Previous LBW or IUGR birth
DCM	111570	Previous fetal malformation/syndrome
SRT	G-0305	History of – premature delivery
DCM	111571	Previous RH negative or blood dyscrasia at birth
SRT	G-0319	History of infertility
DCM	111572	History of multiple fetuses
SRT	D8-20100	Multiple pregnancy
DCM	111573	Current pregnancy, known or suspected malformations/syndromes
DCM	111574	Family history, fetal malformation/syndrome

**CID 6089 Substances**

**Context ID 6089**

**Substances**

**Type: Extensible Version: 20040112**

<b>Coding Scheme Designator (0008,0102)</b>	<b>Code Value (0008,0100)</b>	<b>Code Meaning (0008,0104)</b>
SRT	C-21005	Ethyl alcohol
SRT	F-618FF	Amphetamine
SRT	F-6166C	Marijuana derivative
SRT	F-61C76	Cocaine
SRT	F-61AC4	Heroin
SRT	C-63A10	Lysergic acid diethylamide
SRT	F-6169A	Mescaline
SRT	C-6A180	Phencyclidine
SRT	F-61A95	Methadone
SRT	F-618D7	Morphine
SRT	F-618FE	Methlyphenidate
SRT	C-F3310	Chewing tobacco
SRT	C-F3302	Cigarette smoking tobacco
SRT	F-61117	Caffeine

**CID 6090 Relative Usage, Exposure Amount**

**Context ID 6090**

**Relative Usage, Exposure Amount**

**Type: Extensible Version: 20050822**

<b>Coding Scheme Designator (0008,0102)</b>	<b>Code Value (0008,0100)</b>	<b>Code Meaning (0008,0104)</b>
DCM	111575	High
DCM	111576	Medium
DCM	111577	Low
DCM	111587	No known exposure

**CID 6091      Relative Frequency of Event Values**

**Context ID 6091**

**Relative Frequency of Event Values**

**Type: Extensible      Version: 20040112**

<b>Coding Scheme Designator (0008,0102)</b>	<b>Code Value (0008,0100)</b>	<b>Code Meaning (0008,0104)</b>
SRT	R-40377	Continuous
SRT	G-7154	Frequent
SRT	R-40365	Mid-frequency
SRT	G-7155	Infrequent
SRT	R-40B16	As required
SRT	R-4112F	Single event

**CID 6092      Quantitative Concepts for Usage, Exposure**

**Context ID 6092**

**Quantitative Concepts for Usage, Exposure**

**Type: Extensible      Version: 20040112**

<b>Coding Scheme Designator (0008,0102)</b>	<b>Code Value (0008,0100)</b>	<b>Code Meaning (0008,0104)</b>
SRT	G-C0B7	Dosage
DCM	111578	Dose frequency
DCM	111579	Rate of exposure
DCM	111580	Volume of use

**CID 6093      Qualitative Concepts for Usage, Exposure Amount**

**Context ID 6093**

**Qualitative Concepts for Usage, Exposure Amount**

**Type: Extensible      Version: 20040112**

<b>Coding Scheme Designator (0008,0102)</b>	<b>Code Value (0008,0100)</b>	<b>Code Meaning (0008,0104)</b>
DCM	111581	Relative dose amount
DCM	111582	Relative amount of exposure
DCM	111583	Relative amount of use

**CID 6094      Qualitative Concepts for Usage, Exposure Frequency**

**Context ID 6094**

**Qualitative Concepts for Usage, Exposure Frequency**

**Type: Extensible      Version: 20040112**

<b>Coding Scheme Designator (0008,0102)</b>	<b>Code Value (0008,0100)</b>	<b>Code Meaning (0008,0104)</b>
DCM	111584	Relative dose frequency
DCM	111585	Relative frequency of exposure
DCM	111586	Relative frequency of use

**CID 6095      Numeric Properties of Procedures**

**Context ID 6095**

**Numeric Properties of Procedures**

**Type: Extensible      Version: 20040112**

<b>Coding Scheme Designator (0008,0102)</b>	<b>Code Value (0008,0100)</b>	<b>Code Meaning (0008,0104)</b>
DCM	111465	Needle Gauge
DCM	111467	Needle Length

**CID 6096      Pregnancy Status**

**Context ID 6096**

**Pregnancy Status**

**Type: Extensible      Version: 20040112**

<b>Coding Scheme Designator (0008,0102)</b>	<b>Code Value (0008,0100)</b>	<b>Code Meaning (0008,0104)</b>
SRT	F-81890	not pregnant
SRT	F-84094	possible pregnancy
SRT	F-84000	patient currently pregnant
SRT	R-41198	Unknown

**CID 6097 Side of Family**

**Context ID 6097  
Side of Family**

**Type: Extensible Version: 20040112**

<b>Coding Scheme Designator (0008,0102)</b>	<b>Code Value (0008,0100)</b>	<b>Code Meaning (0008,0104)</b>
DCM	111541	Maternal
SRT	R-40333	Paternal

**CID 6100 Chest Component Categories**

**Context ID 6100  
Chest Component Categories**

**Type: Extensible Version: 20030108**

<b>Coding Scheme Designator (0008,0102)</b>	<b>Code Value (0008,0100)</b>	<b>Code Meaning (0008,0104)</b>
SRT	T-28000	Lung
DCM	112052	Bronchovascular
SRT	T-29000	Pleural structure
SRT	T-D3300	Mediastinum
SRT	T-32000	Heart
DCM	112053	Osseous
SRT	T-4000E	Systemic vascular structure
SRT	R-420AE	Muscular

**CID 6101 Chest Finding or Feature**

**Context ID 6101  
Chest Finding or Feature**

**Type: Extensible Version: 20030108**

<b>Coding Scheme Designator (0008,0102)</b>	<b>Code Value (0008,0100)</b>	<b>Code Meaning (0008,0104)</b>
DCM	112061	Abnormal lines (1D)
DCM	112033	Abnormal opacity
DCM	112062	Abnormal lucency
DCM	112063	Abnormal calcifications
DCM	112064	Abnormal texture
DCM	112005	Radiographic anatomy
DCM	111102	Non-lesion
DCM	111101	Image quality
DCM	111099	Selected region



**CID 6102 Chest Finding or Feature Modifier**

**Context ID 6102**  
**Chest Finding or Feature Modifier**  
**Type: Extensible Version: 20030108**

Coding Scheme Designator (0008,0102)	Code Value (0008,0100)	Code Meaning (0008,0104)
<i>Include Context ID 6103</i>		
<i>Include Context ID 6104</i>		
<i>Include Context ID 6105</i>		
<i>Include Context ID 6106</i>		
<i>Include Context ID 6109</i>		
<i>Include Context ID 6138</i>		

**CID 6103 Abnormal Lines Finding or Feature**

**Context ID 6103**  
**Abnormal Lines Finding or Feature**  
**Type: Extensible Version: 20030108**

Note: Original source of terms is [Fraser and Pare].

Coding Scheme Designator (0008,0102)	Code Value (0008,0100)	Code Meaning (0008,0104)
DCM	112065	Reticulonodular pattern
DCM	112104	Air-fluid level
DCM	112105	Corona radiata
DCM	112106	Honeycomb pattern
DCM	112107	Fleischner's line(s)
DCM	112108	Intralobular lines
DCM	112109	Kerley A line
DCM	112110	Kerley B line
DCM	112111	Kerley C lines
DCM	112112	Parenchymal band
SRT	D2-60302	Plate-like atelectasis
DCM	112113	Reticular pattern
DCM	112114	Septal line(s)
DCM	112115	Subpleural line
DCM	112116	Tramline shadow
DCM	112117	Tubular shadow

**CID 6104            Abnormal Opacity Finding or Feature**

**Context ID 6104**  
**Abnormal Opacity Finding or Feature**  
**Type: Extensible            Version: 20030108**

Note: Original source of terms is [Fraser and Pare].

<b>Coding Scheme Designator (0008,0102)</b>	<b>Code Value (0008,0100)</b>	<b>Code Meaning (0008,0104)</b>
DCM	112066	Beaded septum sign
DCM	112067	Nodular pattern
DCM	112059	Primary complex
DCM	112068	Pseudoplaque
DCM	112065	Reticulonodular pattern
DCM	112069	Signet-ring sign
DCM	112004	Abnormal interstitial pattern
SRT	F-20172	Coin lesion
DCM	112118	Density
DCM	112119	Dependent opacity
DCM	112120	Ground glass opacity
DCM	112121	Infiltrate
SRT	M-03000	Mass
DCM	112122	Micronodule
SRT	M-03010	Nodule
DCM	112001	Opacity
DCM	112123	Phantom tumor (pseudotumor)
DCM	112124	Shadow
DCM	112125	Small irregular opacities
DCM	112126	Small rounded opacities
DCM	112127	Tree-in-bud sign
SRT	D3-40230	Pulmonary embolism

**CID 6105            Abnormal Lucency Finding or Feature**

**Context ID 6105**  
**Abnormal Lucency Finding or Feature**  
**Type: Extensible            Version: 20030108**

Note: Original source of terms is [Fraser and Pare].

<b>Coding Scheme Designator (0008,0102)</b>	<b>Code Value (0008,0100)</b>	<b>Code Meaning (0008,0104)</b>
DCM	112070	Air bronchiogram

<b>Coding Scheme Designator (0008,0102)</b>	<b>Code Value (0008,0100)</b>	<b>Code Meaning (0008,0104)</b>
DCM	112071	Air bronchogram
DCM	112072	Air crescent
SRT	F-20240	Air-trapping
DCM	112073	Halo sign
SRT	D2-81180	Pneumomediastinum
SRT	D2-80300	Pneumothorax

**CID 6106 Abnormal Texture Finding or Feature**

**Context ID 6106**  
**Abnormal Texture Finding or Feature**  
**Type: Extensible Version: 20030108**

Note: Original source of terms is [Fraser and Pare].

<b>Coding Scheme Designator (0008,0102)</b>	<b>Code Value (0008,0100)</b>	<b>Code Meaning (0008,0104)</b>
DCM	112067	Nodular pattern
DCM	112065	Reticulonodular pattern
DCM	112004	Abnormal interstitial pattern
DCM	112128	Granular pattern
DCM	112106	Honeycomb pattern
DCM	112129	Miliary pattern
DCM	112130	Mosaic pattern
DCM	112113	Reticular pattern
DCM	112125	Small irregular opacities

**CID 6107 Width Descriptor**

**Context ID 6107**  
**Width Descriptor**  
**Type: Extensible Version: 20030108**

Note: Original source of terms is [Fraser and Pare].

<b>Coding Scheme Designator (0008,0102)</b>	<b>Code Value (0008,0100)</b>	<b>Code Meaning (0008,0104)</b>
SRT	R-40750	Enlarged
SRT	R-41727	Narrow
DCM	112077	Vasoconstriction
DCM	112078	Vasodilation

**CID 6108 Chest Anatomic Structure Abnormal Distribution**

**Context ID 6108**  
**Chest Anatomic Structure Abnormal Distribution**  
**Type: Extensible Version: 20030108**

Note: Original source of terms is [Fraser and Pare].

<b>Coding Scheme Designator (0008,0102)</b>	<b>Code Value (0008,0100)</b>	<b>Code Meaning (0008,0104)</b>
SRT	F-20240	Air-trapping
DCM	112079	Architectural distortion
DCM	112080	Mosaic perfusion
DCM	112060	Oligemia
DCM	112081	Pleonomia

**CID 6109 Radiographic Anatomy Finding or Feature**

**Context ID 6109**  
**Radiographic Anatomy Finding or Feature**  
**Type: Extensible Version: 20030108**

Note: Original source of terms is [Fraser and Pare].

<b>Coding Scheme Designator (0008,0102)</b>	<b>Code Value (0008,0100)</b>	<b>Code Meaning (0008,0104)</b>
<i>Include Context ID 6110</i>		
<i>Include Context ID 6111</i>		
<i>Include Context ID 6112</i>		
<i>Include Context ID 6113</i>		
<i>Include Context ID 6114</i>		
<i>Include Context ID 6116</i>		
<i>Include Context ID 6117</i>		
DCM	112082	Interface
DCM	112083	Line
DCM	112084	Lucency

**CID 6110 Lung Anatomy Finding or Feature**

**Context ID 6110**  
**Lung Anatomy Finding or Feature**  
**Type: Extensible Version: 20030108**

Note: Original source of terms is [Fraser and Pare].

<b>Coding Scheme Designator (0008,0102)</b>	<b>Code Value (0008,0100)</b>	<b>Code Meaning (0008,0104)</b>
SRT	T-28770	Lobe of lung
DCM	112085	Midlung window
DCM	112054	Secondary pulmonary lobule
SRT	T-280D0	Segment of lung

**CID 6111 Bronchovascular Anatomy Finding or Feature**

**Context ID 6111**  
**Bronchovascular Anatomy Finding or Feature**  
**Type: Extensible Version: 20030108**

Note: Original source of terms is [Fraser and Pare].

<b>Coding Scheme Designator (0008,0102)</b>	<b>Code Value (0008,0100)</b>	<b>Code Meaning (0008,0104)</b>
SRT	T-20001	Airway structure
SRT	T-26000	Bronchus
SRT	T-25201	Carina
DCM	112086	Carina angle
DCM	112087	Centrilobular structures
SRT	T-28080	Hilum of lung

**CID 6112 Pleura Anatomy Finding or Feature**

**Context ID 6112**  
**Pleura Anatomy Finding or Feature**  
**Type: Extensible Version: 20030108**

Note: Original source of terms is [Fraser and Pare].

<b>Coding Scheme Designator (0008,0102)</b>	<b>Code Value (0008,0100)</b>	<b>Code Meaning (0008,0104)</b>
DCM	112088	Anterior junction line
SRT	T-D051D	Fissure of lung
DCM	112089	Posterior junction line

**CID 6113 Mediastinum Anatomy Finding or Feature**

**Context ID 6113**  
**Mediastinum Anatomy Finding or Feature**  
**Type: Extensible Version: 20030108**

Note: Original source of terms is [Fraser and Pare].

<b>Coding Scheme Designator (0008,0102)</b>	<b>Code Value (0008,0100)</b>	<b>Code Meaning (0008,0104)</b>
DCM	112090	Azygoesophageal recess interface
DCM	112091	Paraspinal line
DCM	112092	Posterior tracheal stripe
DCM	112093	Right tracheal stripe
DCM	112094	Stripe
SRT	T-25000	Trachea
SRT	T-56000	Esophagus
SRT	T-B6000	Thyroid
SRT	T-26100	Right main bronchus
SRT	T-26500	Left main bronchus
SRT	T-25201	Carina
SRT	T-D3412	Esophageal Hiatus
SRT	T-14171	Trapezius muscle
SRT	T-15420	Acromioclavicular Joint
SRT	T-D0634	Fascial layer
SRT	T-18774	Axillary Fascia
SRT	T-11240	Costal Cartilage
SRT	T-B4000	Carotid Body
SRT	T-42370	Ligamentum arteriosum
SRT	T-C6510	Thoracic Duct
DCM	112095	Hiatus
SRT	T-C8000	Thymus Gland
SRT	T-C4000	Lymph node
SRT	T-32000	Heart
SRT	T-32400	Ventricle
SRT	T-32100	Atrium
SRT	D4-31220	Atrial Septal Defect
SRT	T-35300	Mitral Valve
SRT	T-35400	Aortic Valve
SRT	T-35100	Tricuspid Valve

**CID 6114 Osseous Anatomy Finding or Feature**

**Context ID 6114**  
**Osseous Anatomy Finding or Feature**  
**Type: Extensible Version: 20030108**

<b>Coding Scheme Designator (0008,0102)</b>	<b>Code Value (0008,0100)</b>	<b>Code Meaning (0008,0104)</b>
SRT	T-11300	Rib
SRT	T-12310	Clavicle
SRT	T-11500	Spine
SRT	T-11210	Sternum
SRT	T-12280	Scapula
SRT	T-12410	Humerus
SRT	T-11510	Vertebra

**CID 6115 Osseous Anatomy Modifiers**

**Context ID 6115**  
**Osseous Anatomy Modifiers**  
**Type: Extensible Version: 20030108**

<b>Coding Scheme Designator (0008,0102)</b>	<b>Code Value (0008,0100)</b>	<b>Code Meaning (0008,0104)</b>
SRT	T-11301	Head of rib
SRT	T-11303	Neck of rib
SRT	T-11304	Tubercle of rib
SRT	T-11309	Shaft of rib
SRT	T-11307	Angle of rib
SRT	T-11308	Costal groove
DCM	112096	Rib Scalene Tubercle
SRT	T-11211	Manubrium of sternum
SRT	T-11218	Suprasternal notch
SRT	T-11219	Clavicular notch of sternum
SRT	T-11221	Sternal angle
SRT	T-11220	Body of sternum
SRT	T-11227	Xiphoid process of sternum
SRT	T-11511	Arch of vertebra
SRT	T-11515	Pedicle of vertebra
SRT	T-11513	Transverse process or vertebra
SRT	T-11514	Lamina of vertebra
SRT	T-1153F	Inferior articular process of vertebra

<b>Coding Scheme Designator (0008,0102)</b>	<b>Code Value (0008,0100)</b>	<b>Code Meaning (0008,0104)</b>
SRT	T-1153E	Superior articular process of vertebra
DCM	112097	Vertebral Intervertebral Notch
SRT	T-11531	Vertebral foramen
SRT	T-1151F	Vertebral canal
SRT	T-11512	Spinous process of vertebra
SRT	T-116EF	Inferior articular facet of axis
SRT	T-116EE	Superior articular facet of axis
SRT	T-12281	Acromion process of scapula
SRT	T-1228A	Glenoid cavity of scapula
DCM	112098	Subscapular Fossa
SRT	T-12287	Dorsal aspect of scapula
DCM	112099	Scapular Spine
DCM	112100	Scapular Supraspinatus Fossa
DCM	112101	Scapular Infraspinatus Fossa
SRT	T-12282	Coracoid process of scapula
SRT	T-D2236	Pectoral girdle

**CID 6116 Muscular Anatomy**

**Context ID 6116  
Muscular Anatomy**

**Type: Extensible Version: 20030108**

<b>Coding Scheme Designator (0008,0102)</b>	<b>Code Value (0008,0100)</b>	<b>Code Meaning (0008,0104)</b>
SRT	T-14110	Pectoralis major muscle
SRT	T-14120	Pectoralis minor muscle
SRT	T-D3400	Diaphragm
SRT	T-1416B	External intercostal muscle
SRT	T-14165	Innermost intercostal muscles
SRT	T-14183	Internal intercostal muscle
SRT	T-14150	Levatores costarum muscles
SRT	T-14166	Subcostal muscle
SRT	T-141A5	Transversus thoracis
SRT	T-14171	Trapezius muscle
SRT	T-13650	Subscapularis muscle
SRT	T-13610	Supraspinatus muscle
SRT	T-13620	Infraspinatus muscle



<b>Coding Scheme Designator (0008,0102)</b>	<b>Code Value (0008,0100)</b>	<b>Code Meaning (0008,0104)</b>
SRT	T-13630	Teres minor muscle
SRT	T-14140	Serratus anterior muscle
SRT	T-13660	Deltoid muscle
SRT	T-14172	Latissimus dorsi muscle
SRT	T-14020	Erector spinae muscle
SRT	T-14030	Iliocostalis muscle
SRT	T-14040	Longissimus muscle
SRT	T-14050	Spinalis muscle
SRT	T-13450	Scalenous anterior muscle
SRT	T-13310	Sternocleidomastoid muscle
SRT	T-13640	Teres major muscle
SRT	T-35020	Chordae tendineae cordis
SRT	T-32410	Interventricular septum
SRT	T-32423	Trabeculae carnae

**CID 6117      Vascular Anatomy**

**Context ID 6117  
Vascular Anatomy**

**Type: Extensible      Version: 20030108**

<b>Coding Scheme Designator (0008,0102)</b>	<b>Code Value (0008,0100)</b>	<b>Code Meaning (0008,0104)</b>
<i>Include Context ID 3015</i>		
SRT	T-46100	Subclavian artery
SRT	T-42100	Ascending aorta
SRT	T-46010	Brachiocephalic trunk
SRT	T-45100	Common carotid artery
SRT	T-46200	Internal thoracic artery
SRT	T-45700	Vertebral artery
SRT	T-46130	Thyrocervical trunk
SRT	T-46180	Costocervical trunk
SRT	T-461A0	Dorsal scapular artery
SRT	T-47100	Axillary Artery
SRT	T-47160	Brachial artery
SRT	T-42300	Aortic arch
SRT	T-48170	Internal jugular vein
SRT	T-48330	Subclavian vein

<b>Coding Scheme Designator (0008,0102)</b>	<b>Code Value (0008,0100)</b>	<b>Code Meaning (0008,0104)</b>
SRT	T-48620	Brachiocephalic vein
SRT	T-48610	Superior vena cava
SRT	T-A9090	Brachial plexus
SRT	T-D0765	Descending aorta
DCM	112102	Aortic knob
SRT	T-42310	Aortic isthmus
SRT	T-48340	Azygos vein
SRT	T-D305A	Intercostal artery
SRT	T-4630D	Esophageal artery
SRT	T-46210	Pericardiophrenic Artery
SRT	T-46350	Superior phrenic artery
SRT	T-46940	Inferior phrenic artery
SRT	T-46310	Bronchial artery
DCM	112103	Arch of the Azygos vein
SRT	T-49110	Axillary vein
SRT	T-48710	Inferior vena cava
SRT	T-44100	Pulmonary trunk
SRT	T-44000	Pulmonary artery
SRT	T-48500	Pulmonary vein

**CID 6118      Size Descriptor**

**Context ID 6118  
Size Descriptor**

**Type: Extensible      Version: 20030108**

<b>Coding Scheme Designator (0008,0102)</b>	<b>Code Value (0008,0100)</b>	<b>Code Meaning (0008,0104)</b>
DCM	112131	Extremely small
DCM	112132	Very small
SRT	R-404A8	Small
SRT	R-404A9	Medium
SRT	R-404AA	Large
SRT	R-40750	Enlarged
DCM	112133	Too small

**CID 6119 Chest Border Shape**

**Context ID 6119  
Chest Border Shape**

**Type: Extensible Version: 20030108**

Note: Original source of terms is [Fraser and Pare].

<b>Coding Scheme Designator (0008,0102)</b>	<b>Code Value (0008,0100)</b>	<b>Code Meaning (0008,0104)</b>
SRT	M-02100	Round shape
DCM	112134	Elliptic
SRT	G-A402	Irregular
DCM	112135	Lobulated
DCM	112136	Spiculated

**CID 6120 Chest Border Definition**

**Context ID 6120  
Chest Border Definition**

**Type: Extensible Version: 20030108**

Note: Original source of terms is [Fraser and Pare].

<b>Coding Scheme Designator (0008,0102)</b>	<b>Code Value (0008,0100)</b>	<b>Code Meaning (0008,0104)</b>
SRT	R-40771	Well defined
DCM	112137	Sharply defined
SRT	R-428E7	Poorly defined
DCM	112138	Distinctly defined
DCM	112139	Well demarcated
DCM	112140	Sharply demarcated
DCM	112141	Poorly demarcated
DCM	112142	Circumscribed

**CID 6121 Chest Orientation Descriptor**

**Context ID 6121  
Chest Orientation Descriptor**

**Type: Extensible Version: 20030108**

<b>Coding Scheme Designator (0008,0102)</b>	<b>Code Value (0008,0100)</b>	<b>Code Meaning (0008,0104)</b>
SRT	G-A142	Horizontal
SRT	G-A144	Vertical
SRT	G-A472	Oblique

**CID 6122 Chest Content Descriptor**

**Context ID 6122**  
**Chest Content Descriptor**  
**Type: Extensible      Version: 20030108**

Note: Original source of terms is [Fraser and Pare].

<b>Coding Scheme Designator (0008,0102)</b>	<b>Code Value (0008,0100)</b>	<b>Code Meaning (0008,0104)</b>
DCM	112143	Air
SRT	T-D008A	Fat
DCM	112144	Soft tissue
DCM	112145	Calcium
SRT	M-30400	Foreign material (iodized oil, mercury, talc)

**CID 6123 Chest Opacity Descriptor**

**Context ID 6123**  
**Chest Opacity Descriptor**  
**Type: Extensible      Version: 20030108**

Note: Original source of terms is [Fraser and Pare].

<b>Coding Scheme Designator (0008,0102)</b>	<b>Code Value (0008,0100)</b>	<b>Code Meaning (0008,0104)</b>
DCM	112146	Acinar
DCM	112147	Air space
DCM	112148	Fibronodular
DCM	112149	Fluffy
DCM	112150	Linear
DCM	112151	Profusion
DCM	112152	Silhouette sign

**CID 6124 Location in Chest**

**Context ID 6124**  
**Location in Chest**  
**Type: Extensible      Version: 20030108**

<b>Coding Scheme Designator (0008,0102)</b>	<b>Code Value (0008,0100)</b>	<b>Code Meaning (0008,0104)</b>
<i>Include CONTEXT ID 6125</i>		
<i>Include CONTEXT ID 6126</i>		
<i>Include CONTEXT ID 6127</i>		

**CID 6125      General Chest Location**

**Context ID 6125**  
**General Chest Location**  
**Type: Extensible      Version: 20030108**

Coding Scheme Designator (0008,0102)	Code Value (0008,0100)	Code Meaning (0008,0104)
SRT	G-A110	Central
SRT	G-A111	Peripheral
SRT	G-A122	Apical
SRT	G-A123	Basal

**CID 6126      Location in Lung**

**Context ID 6126**  
**Location in Lung**  
**Type: Extensible      Version: 20030108**

Coding Scheme Designator (0008,0102)	Code Value (0008,0100)	Code Meaning (0008,0104)
SRT	T-D3208	Upper zone of lung
SRT	T-D3209	Middle zone of lung
SRT	T-D320A	Lower zone of lung
SRT	T-28820	Upper lobe of lung
SRT	T-28825	Middle lobe of lung
SRT	T-28830	Lower lobe of lung
DCM	112153	Subpleural

**CID 6127      Segment Location in Lung**

**Context ID 6127**  
**Segment Location in Lung**  
**Type: Extensible      Version: 20030108**

Coding Scheme Designator (0008,0102)	Code Value (0008,0100)	Code Meaning (0008,0104)
SRT	T-28230	Anterior segment of right upper lobe
SRT	T-28630	Anterior segment of left upper lobe
SRT	T-28220	Posterior segment of right upper lobe

**CID 6128 Chest Distribution Descriptor**

**Context ID 6128**  
**Chest Distribution Descriptor**  
**Type: Extensible Version: 20030108**

Note: Original source of terms is [Fraser and Pare].

<b>Coding Scheme Designator (0008,0102)</b>	<b>Code Value (0008,0100)</b>	<b>Code Meaning (0008,0104)</b>
DCM	112154	Bat's wing distribution
DCM	112155	Butterfly distribution
DCM	112156	Centrilobular
DCM	112157	Coalescent
SRT	G-A321	Diffuse
SRT	M-020FA	Discoid
SRT	G-A324	Disseminated
SRT	G-A351	Focal
SRT	G-A366	Generalized
DCM	112158	Lobar
SRT	G-A443	Multifocal
SRT	G-A137	Segmental
SRT	G-A572	Systemic

**CID 6129 Chest Site Involvement**

**Context ID 6129**  
**Chest Site Involvement**  
**Type: Extensible Version: 20030108**

Note: Original source of terms is [Fraser and Pare].

<b>Coding Scheme Designator (0008,0102)</b>	<b>Code Value (0008,0100)</b>	<b>Code Meaning (0008,0104)</b>
SRT	T-28000	Lung
SRT	T-D3300	Mediastinum
DCM	112158	Lobar
SRT	T-1A007	Interstitial tissue
SRT	R-40939	Bronchial
SRT	T-28080	Hilum of lung
SRT	T-42000	Aorta
SRT	T-29000	Pleural structure
SRT	T-D3050	Chest wall
SRT	T-D4001	Upper abdomen

**CID 6130 Severity Descriptor**

**Context ID 6130**  
**Severity Descriptor**  
**Type: Extensible Version: 20030108**

<b>Coding Scheme Designator (0008,0102)</b>	<b>Code Value (0008,0100)</b>	<b>Code Meaning (0008,0104)</b>
SRT	R-404FA	Mild
SRT	G-A002	Moderate
SRT	G-A003	Severe
SRT	G-A231	Acute
SRT	G-A270	Chronic
DCM	112159	Hyper-acute
SRT	G-A561	Subacute

**CID 6131 Chest Texture Descriptor**

**Context ID 6131**  
**Chest Texture Descriptor**  
**Type: Extensible Version: 20030108**

Note: Original source of terms is [Fraser and Pare].

<b>Coding Scheme Designator (0008,0102)</b>	<b>Code Value (0008,0100)</b>	<b>Code Meaning (0008,0104)</b>
DCM	112160	Homogeneous (uniform opacity)
DCM	112161	Inhomogeneous

**CID 6132 Chest Calcification Descriptor**

**Context ID 6132**  
**Chest Calcification Descriptor**  
**Type: Extensible Version: 20030108**

Note: Original source of terms is [Fraser and Pare].

<b>Coding Scheme Designator (0008,0102)</b>	<b>Code Value (0008,0100)</b>	<b>Code Meaning (0008,0104)</b>
SRT	F-01763	Eggshell calcification
SRT	F-01761	Coarse (popcorn-like) calcification
DCM	112162	Target
SRT	G-A405	Laminated
DCM	112163	Fibrocalcific

<b>Coding Scheme Designator (0008,0102)</b>	<b>Code Value (0008,0100)</b>	<b>Code Meaning (0008,0104)</b>
DCM	112164	Flocculent
SRT	R-403A7	Nodular
SRT	F-12100	Ossification

**CID 6133 Chest Quantitative Temporal Difference Type**

**Context ID 6133**  
**Chest Quantitative Temporal Difference Type**  
**Type: Extensible Version: 20030108**

<b>Coding Scheme Designator (0008,0102)</b>	<b>Code Value (0008,0100)</b>	<b>Code Meaning (0008,0104)</b>
SRT	F-017B1	Difference in size
SRT	F-017B3	Difference in location

**CID 6134 Chest Qualitative Temporal Difference Type**

**Context ID 6134**  
**Chest Qualitative Temporal Difference Type**  
**Type: Extensible Version: 20030108**

<b>Coding Scheme Designator (0008,0102)</b>	<b>Code Value (0008,0100)</b>	<b>Code Meaning (0008,0104)</b>
DCM	112165	Difference in border shape
DCM	112166	Difference in border definition
DCM	112167	Difference in distribution
DCM	112168	Difference in site involvement
DCM	112169	Difference in Type of Content
DCM	112170	Difference in Texture
SRT	F-01722	Finding partially removed
SRT	F-01723	No significant changes in the finding
SRT	M-02520	Increase in size
SRT	M-02530	Decrease in size
SRT	F-01728	Less defined
SRT	F-01729	More defined



**CID 6135 Chest Image Quality Finding**

**Context ID 6135**  
**Chest Image Quality Finding**  
**Type: Extensible Version: 20030108**

<b>Coding Scheme Designator (0008,0102)</b>	<b>Code Value (0008,0100)</b>	<b>Code Meaning (0008,0104)</b>
DCM	111208	Grid artifact(s)
DCM	111209	Positioning
DCM	111210	Motion blur
DCM	111211	Under exposed
DCM	111212	Over exposed
DCM	111213	No image
DCM	111214	Detector artifact(s)
DCM	111215	Artifact(s) other than grid or detector artifact
DCM	111216	Mechanical failure
DCM	111217	Electrical failure
DCM	111218	Software failure
DCM	111219	Inappropriate image processing
DCM	111220	Other failure
DCM	111221	Unknown failure

**CID 6136 Chest Types of Quality Control Standard**

**Context ID 6136**  
**Chest Types of Quality Control Standard**  
**Type: Extensible Version: 20030108**

<b>Coding Scheme Designator (0008,0102)</b>	<b>Code Value (0008,0100)</b>	<b>Code Meaning (0008,0104)</b>
DCM	112035	Performance of Pediatric and Adult Chest Radiography, ACR
DCM	112036	ACR Position Statement
DCM	111240	Institutionally defined quality control standard
DCM	112184	Performance of Pediatric and Adult Thoracic CT
DCM	112185	Performance of CT for Detection of Pulmonary Embolism in Adults
DCM	112186	Performance of High-Resolution CT of the Lungs in Adults

**CID 6137      Types of Chest CAD Analysis**

**Context ID 6137**  
**Types of Chest CAD Analysis**  
**Type: Extensible      Version: 20030108**

<b>Coding Scheme Designator (0008,0102)</b>	<b>Code Value (0008,0100)</b>	<b>Code Meaning (0008,0104)</b>	
SRT	P5-B3402	Spatial collocation analysis	See Note 1
SRT	P5-B3404	Spatial proximity analysis	See Note 2
SRT	P5-B3406	Temporal correlation	
SRT	P5-B3408	Image quality analysis	

- Notes:    1. Spatial Co-location Analysis is used to identify features that are the same or located in the same place.  
            2. Spatial Proximity Analysis is used to identify different features that are related spatially.

**CID 6138      Chest Non-Lesion Object Type**

**Context ID 6138**  
**Chest Non-Lesion Object Type**  
**Type: Extensible      Version: 20030108**

<b>Coding Scheme Designator (0008,0102)</b>	<b>Code Value (0008,0100)</b>	<b>Code Meaning (0008,0104)</b>
SRT	A-32110	Bullet
SRT	A-13600	Staple
SRT	A-13510	Suture material
DCM	111168	Scar tissue
DCM	111171	Pacemaker
SRT	A-040CB	Cardiac pacemaker lead
SRT	A-26800	Catheter
DCM	112172	Portacath
DCM	112173	Chest tube
SRT	A-14611	Vena cava filter
SRT	A-04000	Prosthesis
SRT	A-26430	Feeding tube
SRT	A-26434	Jejunostomy tube
SRT	A-25350	Endotracheal tube
DCM	112174	Central line
SRT	A-12210	Cervical collar
SRT	P1-26100	Tracheotomy
DCM	112175	Kidney stent
SRT	A-11C08	Ureteric stent
DCM	112176	Pancreatic stent

<b>Coding Scheme Designator (0008,0102)</b>	<b>Code Value (0008,0100)</b>	<b>Code Meaning (0008,0104)</b>
DCM	112177	Nipple ring
SRT	A-61000	Jewelry
DCM	112178	Coin
SRT	A-12024	Pin
SRT	A-30360	Needle
SRT	A-04110	Heart valve prosthesis
DCM	112171	Fiducial mark
DCM	111176	Unspecified

**CID 6139 Non-Lesion Modifiers**

**Context ID 6139**

**Non-Lesion Modifiers**

**Type: Extensible Version: 20030108**

<b>Coding Scheme Designator (0008,0102)</b>	<b>Code Value (0008,0100)</b>	<b>Code Meaning (0008,0104)</b>
SRT	R-40819	Internal
SRT	R-40941	External

**CID 6140 Calculation Methods**

**Context ID 6140**

**Calculation Methods**

**Type: Extensible Version: 20050110**

<b>Coding Scheme Designator (0008,0102)</b>	<b>Code Value (0008,0100)</b>	<b>Code Meaning (0008,0104)</b>
SRT	R-10260	Estimated
DCM	112187	Unspecified method of calculation
DCM	112055	Agatston scoring method
DCM	112056	Volume scoring method
DCM	112057	Mass scoring method

**CID 6141      Attenuation Coefficient Measurements**

**Context ID 6141**  
**Attenuation Coefficient Measurements**  
**Type: Extensible      Version: 20030108**

<b>Coding Scheme Designator (0008,0102)</b>	<b>Code Value (0008,0100)</b>	<b>Code Meaning (0008,0104)</b>
DCM	112031	Attenuation Coefficient
DCM	112179	Minimum Attenuation Coefficient
DCM	112180	Maximum Attenuation Coefficient
DCM	112181	Mean Attenuation Coefficient
DCM	112182	Median Attenuation Coefficient
DCM	112183	Standard Deviation of Attenuation Coefficient

**CID 6142      Calculated Value**

**Context ID 6142**  
**Calculated Value**  
**Type: Extensible      Version: 20061023**

<b>Coding Scheme Designator (0008,0102)</b>	<b>Code Value (0008,0100)</b>	<b>Code Meaning (0008,0104)</b>
DCM	112017	Cavity extent as percent of volume
DCM	112018	Calcification extent as percent of surface
DCM	112019	Calcification extent as percent of volume
DCM	112058	Calcium score
DCM	112191	Breast tissue density
DCM	112192	Volume of parenchymal tissue
DCM	112193	Volume of breast
DCM	112194	Mass of parenchymal tissue
DCM	112195	Mass of breast
DCM	112196	Area of Vascular Calcification
DCM	112197	Volume of Vascular Calcification
DCM	112198	Percentage of Vascular Calcification
DCM	112199	Mass of Vascular Calcification

**CID 6143      Response Criteria**

**Context ID 6143  
Response Criteria**

**Type: Extensible      Version: 20030108**

<b>Coding Scheme Designator (0008,0102)</b>	<b>Code Value (0008,0100)</b>	<b>Code Meaning (0008,0104)</b>
<i>Include CONTEXT ID 6144</i>		

**CID 6144      RECIST Response Criteria**

**Context ID 6144  
RECIST Response Criteria**

**Type: Extensible      Version: 20030108**

<b>Coding Scheme Designator (0008,0102)</b>	<b>Code Value (0008,0100)</b>	<b>Code Meaning (0008,0104)</b>
DCM	112041	Target Lesion Complete Response
DCM	112042	Target Lesion Partial Response
DCM	112043	Target Lesion Progressive Disease
DCM	112044	Target Lesion Stable Disease
DCM	112045	Non-Target Lesion Complete Response
DCM	112046	Non-Target Lesion Incomplete Response or Stable Disease
DCM	112047	Non-Target Lesion Progressive Disease

**CID 6145      Baseline Category**

**Context ID 6145  
Baseline Category**

**Type: Extensible      Version: 20030108**

Note: From RECIST

<b>Coding Scheme Designator (0008,0102)</b>	<b>Code Value (0008,0100)</b>	<b>Code Meaning (0008,0104)</b>
DCM	112074	Target Lesion at Baseline
DCM	112075	Non-Target Lesion at Baseline
DCM	112076	Non-Lesion at Baseline

**CID 6151      Background echotexture**

**Context ID 6151  
Background echotexture**

**Type: Extensible      Version: 20050822**

Note: From BI-RADS®

<b>Coding Scheme Designator (0008,0102)</b>	<b>Code Value (0008,0100)</b>	<b>Code Meaning (0008,0104)</b>
DCM	111351	Homogeneous fat echotexture
DCM	111352	Homogeneous fibroglandular echotexture
DCM	111353	Heterogeneous echotexture

**CID 6152      Orientation**

**Context ID 6152**

**Orientation**

**Type: Extensible      Version: 20050822**

Note: From BI-RADS®

<b>Coding Scheme Designator (0008,0102)</b>	<b>Code Value (0008,0100)</b>	<b>Code Meaning (0008,0104)</b>
DCM	111355	Parallel
DCM	111356	Not parallel

**CID 6153      Lesion boundary**

**Context ID 6153**

**Lesion boundary**

**Type: Extensible      Version: 20050822**

Note: From BI-RADS®

<b>Coding Scheme Designator (0008,0102)</b>	<b>Code Value (0008,0100)</b>	<b>Code Meaning (0008,0104)</b>
DCM	111358	Abrupt interface
DCM	111359	Echogenic halo

**CID 6154      Echo pattern**

**Context ID 6154**

**Echo pattern**

**Type: Extensible      Version: 20050822**

Note: From BI-RADS®

<b>Coding Scheme Designator (0008,0102)</b>	<b>Code Value (0008,0100)</b>	<b>Code Meaning (0008,0104)</b>
DCM	111361	Anechoic
DCM	111362	Hyperechoic
DCM	111363	Complex
DCM	111364	Hypoechoic

<b>Coding Scheme Designator (0008,0102)</b>	<b>Code Value (0008,0100)</b>	<b>Code Meaning (0008,0104)</b>
DCM	111365	Isoechoic

**CID 6155      Posterior acoustic features**

**Context ID 6155**

**Posterior acoustic features**

**Type: Extensible      Version: 20060622**

Note: From BI-RADS®

<b>Coding Scheme Designator (0008,0102)</b>	<b>Code Value (0008,0100)</b>	<b>Code Meaning (0008,0104)</b>
DCM	111367	No posterior acoustic features
DCM	111368	Posterior enhancement
DCM	111369	Posterior shadowing
DCM	111370	Combined posterior enhancement and shadowing

**CID 6157      Vascularity**

**Context ID 6157**

**Vascularity**

**Type: Extensible      Version: 20050822**

Note: From BI-RADS®

<b>Coding Scheme Designator (0008,0102)</b>	<b>Code Value (0008,0100)</b>	<b>Code Meaning (0008,0104)</b>
DCM	111373	Vascularity not present
DCM	111374	Vascularity not assessed
DCM	111375	Vascularity present in lesion
DCM	111376	Vascularity present immediately adjacent to lesion
DCM	111377	Diffusely increased vascularity in surrounding tissue

**CID 6158      Correlation to Other Findings**

**Context ID 6158**

**Correlation to Other Findings**

**Type: Extensible      Version: 20050822**

Note: From BI-RADS®

<b>Coding Scheme Designator (0008,0102)</b>	<b>Code Value (0008,0100)</b>	<b>Code Meaning (0008,0104)</b>
DCM	111381	Correlates to physical exam findings
DCM	111382	Correlates to mammography findings
DCM	111383	Correlates to MRI findings
DCM	111384	Correlates to ultrasound findings
DCM	111385	Correlates to other imaging findings
DCM	111386	No correlation to other imaging findings
DCM	111387	No correlation to clinical findings

**CID 6159 Malignancy Type**

**Context ID 6159**

**Malignancy Type**

**Type: Extensible Version: 20050822**

Note: From BI-RADS®

<b>Coding Scheme Designator (0008,0102)</b>	<b>Code Value (0008,0100)</b>	<b>Code Meaning (0008,0104)</b>
DCM	111389	Invasive breast carcinoma
SRT	M-85002	Intraductal carcinoma, non-infiltrating
DCM	111390	Other malignancy type

**CID 6160 Breast Primary Tumor Assessment from AJCC**

**Context ID 6160**

**Breast Primary Tumor Assessment from AJCC**

**Type: Extensible Version: 20050822**

<b>Coding Scheme Designator (0008,0102)</b>	<b>Code Value (0008,0100)</b>	<b>Code Meaning (0008,0104)</b>
SRT	R-003B8	TX: Primary tumor cannot be assessed (breast)
SRT	R-003B9	T0: No evidence of primary tumor (breast)
SRT	R-003BB	Tis: Carcinoma in situ (breast)
SRT	R-003BC	Tis: Ductal carcinoma in situ (breast)
SRT	R-003BD	Tis: Lobular carcinoma in situ (breast)
SRT	R-003BE	Tis: Paget's disease of the nipple with no tumor
SRT	R-003BA	T1: Tumor 2 cm or less in greatest dimension (breast)
SRT	R-003BF	T1mic: Microinvasion 0.1 cm or less in greatest dimension...
SRT	R-003C0	T1a: Tumor more than 0.1 cm but not more than 0.5 cm...



<b>Coding Scheme Designator (0008,0102)</b>	<b>Code Value (0008,0100)</b>	<b>Code Meaning (0008,0104)</b>
SRT	R-003C1	T1b: Tumor more than 0.5 cm but not more than 1 cm...
SRT	R-003C2	T1c: Tumor more than 1 cm but not more than 2 cm...
SRT	R-003C3	T2: Tumor more than 2 cm but not more than 5 cm...
SRT	R-003C4	T3: Tumor more than 5 cm in greatest dimension (breast)
SRT	R-003C5	T4: Tumor of any size with direct extension to chest wall...
SRT	R-003C6	T4a: Tumor of any size with extension to chest wall, not incl...
SRT	R-003C7	T4b: Tumor of any size with edema (including peau d'orange)...
SRT	R-003C8	T4c: Tumor of any size with direct extension to chest wall...
SRT	R-003C9	T4: Inflammatory carcinoma (breast)

**CID 6161 Clinical Regional Lymph Node Assessment for Breast**

**Context ID 6161**

**Clinical Regional Lymph Node Assessment for Breast**

**Type: Extensible Version: 20050822**

<b>Coding Scheme Designator (0008,0102)</b>	<b>Code Value (0008,0100)</b>	<b>Code Meaning (0008,0104)</b>
SRT	R-003CA	NX: Regional lymph nodes cannot be assessed...
SRT	R-003CB	N0: No regional lymph node metastasis histologically...
SRT	R-003D0	N1: Metastasis in 1to3 axillary lymph nodes...
SRT	R-003D6	N2: Metastasis in 4 to 9 axillary lymph nodes...
SRT	R-003D7	N2a: Metastasis in 4 to 9 axillary lymph nodes (...2.0 mm)...
SRT	R-003D8	N2b: Metastasis in clinically apparent internal... nodes...
SRT	G-F749	N3: Metastasis to ipsilateral internal mammary lymph node(s)
SRT	R-003D9	N3a: Metastasis in 10 or more axillary lymph nodes...
SRT	R-003DA	N3b: Metastasis in clinically apparent ipsilateral internal...
SRT	R-003DB	N3c: Metastasis in ipsilateral supraclavicular lymph nodes...

**CID 6162      Assessment of Metastasis for Breast**

**Context ID 6162**

**Assessment of Metastasis for Breast**

**Type: Extensible      Version: 20050822**

<b>Coding Scheme Designator (0008,0102)</b>	<b>Code Value (0008,0100)</b>	<b>Code Meaning (0008,0104)</b>
SRT	R-003DC	MX: Distant metastasis cannot be assessed (breast)
SRT	R-003DD	M0: No distant metastasis (breast)
SRT	R-003DE	M1: Distant metastasis (breast)

**CID 6163      Menstrual Cycle Phase**

**Context ID 6163**

**Menstrual Cycle Phase**

**Type: Extensible      Version: 20050822**

Note: From BI-RADS®

<b>Coding Scheme Designator (0008,0102)</b>	<b>Code Value (0008,0100)</b>	<b>Code Meaning (0008,0104)</b>
DCM	111392	1st week
DCM	111393	2nd week
DCM	111394	3rd week
SRT	F-840B3	Menstruation present

**CID 6164      Time Intervals**

**Context ID 6164**

**Time Intervals**

**Type: Extensible      Version: 20050822**

<b>Coding Scheme Designator (0008,0102)</b>	<b>Code Value (0008,0100)</b>	<b>Code Meaning (0008,0104)</b>
DCM	111396	< 3 months ago
DCM	111397	4 months to 1 year ago
DCM	111398	> 1 year ago
DCM	111399	Not sure

**CID 6165 Breast Linear Measurements**

**Context ID 6165**

**Breast Linear Measurements**

**Type: Extensible Version: 20050822**

<b>Coding Scheme Designator (0008,0102)</b>	<b>Code Value (0008,0100)</b>	<b>Code Meaning (0008,0104)</b>
<i>Include CID 7470 Linear Measurements</i>		
DCM	121242	Distance from nipple
DCM	121243	Distance from skin
DCM	121244	Distance from chest wall

**CID 6166 CAD Geometry Secondary Graphical Representation**

**Context ID 6166**

**CAD Geometry Secondary Graphical Representation**

**Type: Extensible Version: 20060822**

<b>Coding Scheme Designator (0008,0102)</b>	<b>Code Value (0008,0100)</b>	<b>Code Meaning (0008,0104)</b>
DCM	113661	Outline of lobulations
DCM	113662	Inner limits of fuzzy margin
DCM	113663	Outer limits of fuzzy margin
DCM	113664	Outline of spiculations
DCM	113665	Linear spiculation
DCM	113666	Pixelated spiculations
SRT	G-A185	Long axis
SRT	G-A186	Short axis
DCM	113669	Orthogonal location arc
DCM	113670	Orthogonal location arc inner margin
DCM	113671	Orthogonal location arc outer margin

**CID 7000 Diagnostic Imaging Report Document Titles**

**Context ID 7000  
Diagnostic Imaging Report Document Titles**

**Type: Extensible Version: 20020904**

<b>Coding Scheme Designator (0008,0102)</b>	<b>Code Value (0008,0100)</b>	<b>Code Meaning (0008,0104)</b>
LN	18745-0	Cardiac Catheteization Report
LN	11540-2	CT Abdomen Report
LN	11538-6	CT Chest Report
LN	11539-4	CT Head Report
LN	18747-6	CT Report
LN	18748-4	Diagnostic Imaging Report
LN	11522-0	Echocardiography Report
LN	18760-9	Ultrasound Report
LN	11541-0	MRI Head Report
LN	18755-9	MRI Report
LN	18756-7	MRI Spine Report
LN	18757-5	Nuclear Medicine Report
LN	11525-3	Ultrasound Obstetric and Gyn Report
LN	18758-3	PET Scan Report
LN	11528-7	Radiology Report

**CID 7001 Diagnostic Imaging Report Headings**

**Context ID 7001**  
**Diagnostic Imaging Report Headings**  
**Type: Extensible Version: 20050615**

<b>Coding Scheme Designator (0008,0102)</b>	<b>Code Value (0008,0100)</b>	<b>Code Meaning (0008,0104)</b>
DCM	121060	History
DCM	121062	Request
DCM	121064	Current Procedure Descriptions
DCM	121066	Prior Procedure Descriptions
DCM	121068	Previous Findings
DCM	121070	Findings
DCM	121072	Impressions
DCM	121074	Recommendations
DCM	121076	Conclusions
DCM	121078	Addendum
DCM	121109	Indications for Procedure
DCM	121110	Patient Presentation
DCM	121113	Complications
DCM	121111	Summary
DCM	121180	Key Images

**CID 7002 Diagnostic Imaging Report Elements**

**Context ID 7002**  
**Diagnostic Imaging Report Elements**  
**Type: Extensible Version: 20030327**

<b>Coding Scheme Designator (0008,0102)</b>	<b>Code Value (0008,0100)</b>	<b>Code Meaning (0008,0104)</b>
DCM	121060	History
DCM	121062	Request
DCM	121065	Procedure Description
DCM	121069	Previous Finding
DCM	121071	Finding
DCM	121073	Impression
DCM	121075	Recommendation
DCM	121077	Conclusion
SRT	DD-60002	Complication of Procedure
DCM	121110	Patient Presentation
DCM	121111	Summary

**CID 7003 Diagnostic Imaging Report Purposes of Reference**

**Context ID 7003**  
**Diagnostic Imaging Report Purposes of Reference**  
Type: Extensible Version: 20030327

<b>Coding Scheme Designator (0008,0102)</b>	<b>Code Value (0008,0100)</b>	<b>Code Meaning (0008,0104)</b>
DCM	121079	Baseline
DCM	121080	Best illustration of finding
DCM	121112	Source of Measurement

**CID 7004 Waveform Purposes of Reference**

**Context ID 7004**  
**Waveform Purposes of Reference**  
Type: Extensible Version: 20020904

<b>Coding Scheme Designator (0008,0102)</b>	<b>Code Value (0008,0100)</b>	<b>Code Meaning (0008,0104)</b>
DCM	121301	Simultaneous Doppler
DCM	121302	Simultaneous Hemodynamic
DCM	121303	Simultaneous ECG
DCM	121304	Simultaneous Voice Narrative

**CID 7005 Contributing Equipment Purposes of Reference**

**Context ID 7005**  
**Contributing Equipment Purposes of Reference**  
Type: Extensible Version: 20061024

<b>Coding Scheme Designator (0008,0102)</b>	<b>Code Value (0008,0100)</b>	<b>Code Meaning (0008,0104)</b>
DCM	109101	Acquisition Equipment
DCM	109102	Processing Equipment
DCM	109103	Modifying Equipment
DCM	MEDIM	Portable Media Importer Equipment
DCM	FILMD	Film Digitizer
DCM	DOCD	Document Digitizer Equipment
DCM	VIDD	Video Tape Digitizer Equipment

**CID 7006 SR Document Purposes of Reference**

**Context ID 7006**  
**SR Document Purposes of Reference**  
**Type: Extensible Version: 20061023**

<b>Coding Scheme Designator (0008,0102)</b>	<b>Code Value (0008,0100)</b>	<b>Code Meaning (0008,0104)</b>
DCM	121331	Equivalent CDA Document
DCM	121332	Complete Rendering for Presentation
DCM	121333	Partial Rendering for Presentation
DCM	121334	Extended Rendering for Presentation
DCM	121335	Source Document

**CID 7007 Signature Purpose**

Context Group ID 7007 comprises the signature purposes codes of ASTM E 2084-00. The Coding Scheme Designator (0008,0102) shall be "ASTM-sigpurpose". The ASTM document defines the signature purpose codes as OIDs. For the purposes of this Coding Scheme only the leaf digit is used as the Code Value (0008,0100).

Note: ASTM E 1762 provides the full definitions for the signature purpose OIDs defined by E 2084. The recommended Code Meanings (0008,0104) are the titles of the definitions for the leaves of the OIDs. For example, the OID 1.2.840.10065.1.12.1 corresponds to the leaf "id-purpose-author", whose meaning could be encoded as "Author Signature" and whose code value is 1.

**CID 7008 Media Import**

This Context Group specifies items that may be conveyed in the Billing and Materials Management Module (see PS3.3).

**Context ID 7008**  
**Media Import**  
**Type: Extensible Version: 20061024**

<b>Coding Scheme Designator (0008,0102)</b>	<b>Code Value (0008,0100)</b>	<b>Code Meaning (0008,0104)</b>
DCM	110020	Sheet Film Digitized
DCM	110021	Cine Film Digitized
DCM	110022	Video Tape Digitized
DCM	110023	Paper Digitized
DCM	110024	CD Imported
DCM	110025	DVD Imported
DCM	110026	MOD Imported
DCM	110027	Studies Imported
DCM	110028	Instances Imported

**CID 7010 Key Object Selection Document Title**

**Context ID 7010**  
**Key Object Selection Document Title**  
**Type: Extensible Version: 20040920**

<b>Coding Scheme Designator (0008,0102)</b>	<b>Code Value (0008,0100)</b>	<b>Code Meaning (0008,0104)</b>
DCM	113000	Of Interest
DCM	113001	Rejected for Quality Reasons
DCM	113002	For Referring Provider
DCM	113003	For Surgery
DCM	113004	For Teaching
DCM	113005	For Conference
DCM	113006	For Therapy
DCM	113007	For Patient
DCM	113008	For Peer Review
DCM	113009	For Research
DCM	113010	Quality Issue
DCM	113013	Best In Set
DCM	113018	For Printing
DCM	113020	For Report Attachment
DCM	113030	Manifest
DCM	113031	Signed Manifest
DCM	113032	Complete Study Content
DCM	113033	Signed Complete Study Content
DCM	113034	Complete Acquisition Content
DCM	113035	Signed Complete Acquisition Content
DCM	113036	Group of Frames for Display

**CID 7011 Rejected for Quality Reasons**

**Context ID 7011**  
**Rejected for Quality Reasons**  
**Type: Extensible Version: 20020904**

<b>Coding Scheme Designator (0008,0102)</b>	<b>Code Value (0008,0100)</b>	<b>Code Meaning (0008,0104)</b>
DCM	111207	Image artifact(s)
DCM	111208	Grid artifact(s)
DCM	111209	Positioning
DCM	111210	Motion blur
DCM	111211	Under exposed
DCM	111212	Over exposed
DCM	111213	No image



DCM	111214	Detector artifact(s)
DCM	111215	Artifact(s) other than grid or detector artifact
DCM	111216	Mechanical failure
DCM	111217	Electrical failure
DCM	111218	Software failure
DCM	111219	Inappropriate image processing
DCM	111220	Other failure
DCM	111221	Unknown failure
DCM	113026	Double exposure

**CID 7012 Best In Set**

**Context ID 7012  
Best In Set**

**Type: Extensible Version: 20020904**

<b>Coding Scheme Designator (0008,0102)</b>	<b>Code Value (0008,0100)</b>	<b>Code Meaning (0008,0104)</b>
DCM	113014	Study
DCM	113015	Series
DCM	113016	Performed Procedure Step
DCM	113017	Stage-View

**CID 7020 Document Titles**

Context Group ID 7020 comprises all document names (i.e., terms with Scale “DOC”) within the HIPAA Attachments class of the LOINC coding scheme. The Coding Scheme Designator shall be LN.

- Note:
1. A subset of this Context Group directly applicable to imaging reports is in CID 7000.
  2. The LOINC coding scheme can be found at: <http://www.regenstrief.org/loinc>

**CID 7100 RCS Registration Method Type**

**Context ID 7100**

**RCS Registration Method Type**

**Type: Extensible Version: 20040115**

<b>Coding Scheme Designator (0008,0102)</b>	<b>Code Value (0008,0100)</b>	<b>Code Meaning (0008,0104)</b>
DCM	125021	Frame of Reference Identity
DCM	125023	Acquisition Equipment Alignment
DCM	125025	Visual Alignment
DCM	125022	Fiducial Alignment
DCM	125024	Image Content-based Alignment

**CID 7101 Brain Atlas Fiducials**

**Context ID 7101  
Brain Atlas Fiducials**

**Type: Extensible Version: 20040115**

<b>Coding Scheme Designator (0008,0102)</b>	<b>Code Value (0008,0100)</b>	<b>Code Meaning (0008,0104)</b>
DCM	125030	Inter-Hemispheric Plane
SRT	T-A2980	Anterior Commissure
SRT	T-A4904	Posterior Commissure
DCM	125031	Right Hemisphere Most Anterior
DCM	125032	Right Hemisphere Most Posterior
DCM	125033	Right Hemisphere Most Superior
DCM	125034	Right Hemisphere Most Inferior
DCM	125035	Left Hemisphere Most Anterior
DCM	125036	Left Hemisphere Most Posterior
DCM	125037	Left Hemisphere Most Superior
DCM	125038	Left Hemisphere Most Inferior

**CID 7150 Segmentation Property Categories**

**Context ID 7150**

**Segmentation Property Categories**

**Type: Extensible Version: 20060822**

<b>Coding Scheme Designator (0008,0102)</b>	<b>Code Value (0008,0100)</b>	<b>Code Meaning (0008,0104)</b>
SRT	T-D0050	Tissue
SRT	T-D000A	Anatomical Structure
SRT	A-00004	Physical object
SRT	M-01000	Morphologically Altered Structure
SRT	R-42019	Function

**CID 7151 Segmentation Property Types**

**Context ID 7151**

**Segmentation Property Types**

**Type: Extensible Version: 20060822**

<b>Coding Scheme Designator (0008,0102)</b>	<b>Code Value (0008,0100)</b>	<b>Code Meaning (0008,0104)</b>
		INCLUDE CID 8 Angiographic Interventional Devices
		INCLUDE CID 3010 Cardiovascular Anatomic Locations
		INCLUDE CID 3827 Vessel Segments

INCLUDE CID 3829 Pulmonary Arteries
INCLUDE CID 4031 Common Anatomic Regions
INCLUDE CID 6040 Non-Lesion Object Type
INCLUDE CID 6138 Chest Non-Lesion Object Type
INCLUDE CID 7152 Cardiac Structure Segmentation Types
INCLUDE CID 7153 Brain Tissue Segmentation Types
INCLUDE CID 7154 Abdominal Organ Segmentation Types
INCLUDE CID 7155 Thoracic Tissue Segmentation Types
INCLUDE CID 7156 Vascular Tissue Segmentation Types
INCLUDE CID 7157 Device Segmentation Types
INCLUDE CID 7158 Artifact Segmentation Types
INCLUDE CID 7159 Lesion Segmentation Types
INCLUDE CID 7160 Pelvic Organ Segmentation Types
INCLUDE CID 7161 Physiology Segmentation Types

Note: This set is expected to be extended as various applications further define segmentation properties.

**CID 7152            Cardiac Structure Segmentation Types**

**Context ID 7152**

**Cardiac Structure Segmentation Types**

**Type: Extensible Version: 20060822**

<b>Coding Scheme Designator (0008,0102)</b>	<b>Code Value (0008,0100)</b>	<b>Code Meaning (0008,0104)</b>
SRT	T-32000	Heart
SRT	T-42000	Aorta
SRT	T-32600	Left Ventricle
SRT	T-32500	Right Ventricle

**CID 7153 Brain Tissue Segmentation Types**

**Context ID 7153**

**Brain Tissue Segmentation Types**

**Type: Extensible Version: 20060822**

<b>Coding Scheme Designator (0008,0102)</b>	<b>Code Value (0008,0100)</b>	<b>Code Meaning (0008,0104)</b>
SRT	T-A2030	White Matter
SRT	T-A2020	Grey Matter
SRT	T-A1000	Cerebrospinal Fluid
SRT	T-A1110	Meninges
SRT	T-11100	Skull

**CID 7154 Abdominal Organ Segmentation Types**

**Context ID 7154**

**Abdominal Organ Segmentation Types**

**Type: Extensible Version: 20060822**

<b>Coding Scheme Designator (0008,0102)</b>	<b>Code Value (0008,0100)</b>	<b>Code Meaning (0008,0104)</b>
SRT	T-62000	Liver
SRT	T-C3000	Spleen
SRT	T-71000	Kidney
SRT	T-B3000	Adrenal gland
SRT	T-42000	Aorta
SRT	T-48710	Inferior vena cava

**CID 7155 Thoracic Tissue Segmentation Types**

**Context ID 7155**

**Thoracic Tissue Segmentation Types**

**Type: Extensible Version: 20060822**

<b>Coding Scheme Designator (0008,0102)</b>	<b>Code Value (0008,0100)</b>	<b>Code Meaning (0008,0104)</b>
SRT	T-28000	Lung
SRT	T-D3400	Diaphragm
SRT	T-26000	Bronchi
SRT	T-40000	Blood Vessel
SRT	T-D3300	Mediastinum
SRT	T-D016E	Bone

**CID 7156      Vascular Tissue Segmentation Types**

**Context ID 7156**

**Vascular Tissue Segmentation Types**

**Type: Extensible Version: 20060822**

<b>Coding Scheme Designator (0008,0102)</b>	<b>Code Value (0008,0100)</b>	<b>Code Meaning (0008,0104)</b>
SRT	T-40230	Lumen
SRT	T-1A170	Intima
SRT	T-40210	Media
SRT	T-1A190	Adventitia
SRT	M-35001	Thrombus
SRT	M-520F8	Vascular sclerosis

**CID 7157      Device Segmentation Types**

**Context ID 7157**

**Device Segmentation Types**

**Type: Extensible Version: 20060822**

<b>Coding Scheme Designator (0008,0102)</b>	<b>Code Value (0008,0100)</b>	<b>Code Meaning (0008,0104)</b>
SRT	A-25500	Stent
SRT	A-12030	Bone Screw
SRT	A-12024	Bone Pin
SRT	A-11100	Pacemaker
SRT	A-11206	Defibrillator
SRT	A-11FCD	Left ventricular assist device
SRT	A-04034	Radioactive implant
SRT	A-04200	Dental Prosthesis
SRT	A-04036	Inlay Dental Restoration

**CID 7158      Artifact Segmentation Types**

**Context ID 7158**

**Artifact Segmentation Types**

**Type: Extensible Version: 20060822**

<b>Coding Scheme Designator (0008,0102)</b>	<b>Code Value (0008,0100)</b>	<b>Code Meaning (0008,0104)</b>
SRT	A-00916	Clothing
SRT	A-17350	Table

**CID 7159      Lesion Segmentation Types**

**Context ID 7159**

**Lesion Segmentation Types**

**Type: Extensible Version: 20060822**

<b>Coding Scheme Designator (0008,0102)</b>	<b>Code Value (0008,0100)</b>	<b>Code Meaning (0008,0104)</b>
SRT	M-8FFFF	Neoplasm
SRT	M-03010	Nodule
SRT	M-3340A	Cyst
SRT	M-54000	Necrosis
SRT	M-40000	Inflammation
SRT	M-41610	Abscess

**CID 7160 Pelvic Organ Segmentation Types**

**Context ID 7160**

**Pelvic Organ Segmentation Types**

**Type: Extensible Version: 20060822**

<b>Coding Scheme Designator (0008,0102)</b>	<b>Code Value (0008,0100)</b>	<b>Code Meaning (0008,0104)</b>
SRT	T-94000	Testis
SRT	T-83000	Uterus
SRT	T-87000	Ovary
SRT	T-83200	Cervix
SRT	T-92000	Prostate
SRT	T-93000	Seminal Vesicle
SRT	T-59600	Rectum
SRT	T-74000	Bladder
SRT	T-13001	Muscle
SRT	T-40000	Blood Vessel
SRT	T-D016E	Bone

**CID 7161 Physiology Segmentation Types**

**Context ID 7161**

**Physiology Segmentation Types**

**Type: Extensible Version: 20060822**

<b>Coding Scheme Designator (0008,0102)</b>	<b>Code Value (0008,0100)</b>	<b>Code Meaning (0008,0104)</b>
SRT	R-0039F	Perfusion

**CID 7201      Referenced Image Purposes of Reference**

**Context ID 7201  
Referenced Image Purposes of Reference  
Type: Extensible Version: 20020904**

<b>Coding Scheme Designator (0008,0102)</b>	<b>Code Value (0008,0100)</b>	<b>Code Meaning (0008,0104)</b>
DCM	121311	Localizer
DCM	121312	Biopsy localizer
DCM	121313	Other partial views
DCM	121314	Other image of biplane pair
DCM	121315	Other image of stereoscopic pair
DCM	121316	Images related to standalone object
DCM	121317	Spectroscopy
DCM	121338	Anatomic image
DCM	121339	Functional image
DCM	121340	Spectral filtered image
DCM	121341	Device localizer

**CID 7202      Source Image Purposes of Reference**

**Context ID 7202  
Source Image Purposes of Reference  
Type: Extensible Version: 20051101**

<b>Coding Scheme Designator (0008,0102)</b>	<b>Code Value (0008,0100)</b>	<b>Code Meaning (0008,0104)</b>
DCM	121320	Uncompressed predecessor
DCM	121321	Mask image for image processing operation
DCM	121322	Source image for image processing operation
DCM	121329	Source image for montage
DCM	121330	Lossy compressed predecessor



CID 7203 Image Derivation

Context ID 7203  
Image Derivation

Type: Extensible Version: 20050822

Coding Scheme Designator (0008,0102)	Code Value (0008,0100)	Code Meaning (0008,0104)
DCM	113040	Lossy Compression
DCM	113041	Apparent Diffusion Coefficient
DCM	113042	Pixel by pixel addition
DCM	113043	Diffusion weighted
DCM	113044	Diffusion Anisotropy
DCM	113045	Diffusion Attenuated
DCM	113046	Pixel by pixel division
DCM	113047	Pixel by pixel mask
DCM	113048	Pixel by pixel Maximum
DCM	113049	Pixel by pixel mean
DCM	113050	Metabolite Maps from spectroscopy data
DCM	113051	Pixel by pixel Minimum
DCM	113052	Mean Transit Time
DCM	113053	Pixel by pixel multiplication
DCM	113054	Negative Enhancement Integral
DCM	113055	Regional Cerebral Blood Flow
DCM	113056	Regional Cerebral Blood Volume
DCM	113057	R-Coefficient Map
DCM	113058	Proton Density map
DCM	113059	Signal Change Map
DCM	113060	Signal to Noise Map
DCM	113061	Standard Deviation
DCM	113062	Pixel by pixel subtraction
DCM	113063	T1 Map
DCM	113064	T2* Map
DCM	113065	T2 Map
DCM	113066	Time Course of Signal
DCM	113067	Temperature encoded
DCM	113068	Student's T-Test
DCM	113069	Time To Peak map
DCM	113070	Velocity encoded
DCM	113071	Z-Score Map
DCM	113072	Multiplanar reformatting
DCM	113073	Curved multiplanar reformatting

DCM	113074	Volume rendering
DCM	113075	Surface rendering
DCM	113076	Segmentation
DCM	113077	Volume editing
DCM	113078	Maximum intensity projection
DCM	113079	Minimum intensity projection
DCM	113085	Spatial resampling
DCM	113086	Edge enhancement
DCM	113087	Smoothing
DCM	113088	Gaussian blur
DCM	113089	Unsharp mask
DCM	113090	Image stitching

**CID 7205 Purpose Of Reference to Alternate Representation**

**Context ID 7205**

**Purpose Of Reference to Alternate Representation**

**Type: Extensible**

**Version: 20040322**

<b>Coding Scheme Designator (0008,0102)</b>	<b>Code Value (0008,0100)</b>	<b>Code Meaning (0008,0104)</b>
DCM	121324	Source image
DCM	121325	Lossy compressed image
DCM	121326	Alternate SOP Class instance
DCM	121327	Full fidelity image
DCM	121328	Alternate Photometric Interpretation image

**CID 7210 Related Series Purposes Of Reference**

**Context ID 7210**

**Related Series Purposes of Reference**

**Type: Extensible**

**Version: 20030619**

<b>Coding Scheme Designator (0008,0102)</b>	<b>Code Value (0008,0100)</b>	<b>Code Meaning (0008,0104)</b>
DCM	122400	Simultaneously Acquired
DCM	122401	Same Anatomy
DCM	122402	Same Indication
DCM	122403	For Attenuation Correction

**CID 7450      Person Roles**

**Context ID 7450**

**Person Roles**

**Type: Extensible      Version: 20040112**

<b>Coding Scheme Designator (0008,0102)</b>	<b>Code Value (0008,0100)</b>	<b>Code Meaning (0008,0104)</b>
DCM	121025	Patient
SRT	J-00552	Healthcare professional
SRT	S-11090	Friend
<i>Include CID 7451</i>		
<i>Include CID 7452</i>		

**CID 7451      Family Member**

**Context ID 7451**

**Family Member**

**Type: Extensible      Version: 20040112**

<b>Coding Scheme Designator (0008,0102)</b>	<b>Code Value (0008,0100)</b>	<b>Code Meaning (0008,0104)</b>
SRT	S-10121	Natural mother
SRT	S-10131	Natural father
SRT	S-10151	Natural sister
SRT	S-10161	Natural brother
SRT	S-101A1	Aunt
SRT	S-101A2	Uncle
SRT	S-10154	Half-sister
SRT	S-10164	Half-brother
SRT	S-10115	Natural grand-mother
SRT	S-10116	Natural grand-father
SRT	S-10181	Natural daughter
SRT	S-10191	Natural son
SRT	S-101A9	Female first cousin
SRT	S-101AA	Male first cousin

**CID 7452      Organizational Roles**

**Context ID 7452  
Organizational Roles**

**Type: Extensible Version: 20020904**

<b>Coding Scheme Designator (0008,0102)</b>	<b>Code Value (0008,0100)</b>	<b>Code Meaning (0008,0104)</b>
DCM	121081	Physician
DCM	121082	Nurse
DCM	121083	Technologist
DCM	121084	Radiographer
DCM	121085	Intern
DCM	121086	Resident
DCM	121087	Registrar
DCM	121088	Fellow
DCM	121089	Attending [Consultant]
DCM	121090	Scrub nurse
DCM	121091	Surgeon
DCM	121092	Sonologist
DCM	121093	Sonographer
DCM	121105	Radiation Physicist

**CID 7453      Performing Roles**

**Context ID 7453  
Performing Roles**

**Type: Extensible Version: 20020904**

<b>Coding Scheme Designator (0008,0102)</b>	<b>Code Value (0008,0100)</b>	<b>Code Meaning (0008,0104)</b>
DCM	121094	Performing
DCM	121095	Referring
DCM	121096	Requesting
DCM	121097	Recording
DCM	121098	Verifying
DCM	121099	Assisting
DCM	121100	Circulating
DCM	121101	Standby

**CID 7454 Species**

**Context ID 7454  
Species**

**Type: Extensible Version: 20060822**

<b>Coding Scheme Designator (0008,0102)</b>	<b>Code Value (0008,0100)</b>	<b>Code Meaning (0008,0104)</b>
SNM3	L-85B00	homo sapiens
SRT	L-80A00	Feline species
SRT	L-80400	Equine species
SRT	L-80300	Ovine species
SRT	L-80500	Porcine species
SRT	L-80200	Caprine species
SRT	L-80700	Canine species
SRT	L-80100	Bovine species

**CID 7455 Sex**

This Context Group includes terms for the finding of sex of a subject for clinical purposes, such as selection of sex-based growth metrics.

**Context ID 7455  
Sex**

**Type: Non-Extensible Version: 20040112**

<b>Coding Scheme Designator (0008,0102)</b>	<b>Code Value (0008,0100)</b>	<b>Code Meaning (0008,0104)</b>	<b>Patient's Sex (0010,0040) Equivalent</b>
DCM	M	Male	M
DCM	F	Female	F
DCM	U	Unknown sex	
DCM	MP	Male Pseudohermaphrodite	
DCM	FP	Female Pseudohermaphrodite	
DCM	H	Hermaphrodite	
DCM	MC	Male changed to Female	
DCM	FC	Female changed to Male	
DCM	121104	Ambiguous sex	
DCM	121102	Other sex	
DCM	121103	Undetermined sex	O

- Notes:
1. These terms are distinct from the gender of a subject for administrative purposes, although the default value for clinical sex is often based on the administrative gender (e.g., see TID 1007). The administrative value "O" from Patient's Sex (0010,0040) maps by default to "undetermined" for clinical purposes.
  2. This Context Group in a prior edition of the Standard included codes improperly attributed to ISO 5218.

3. These terms are derived from the terminology and codes for sex in ASTM E1633-02a "Standard Specification for Coded Values Used in the Electronic Health Record."

**CID 7456 Units of Measure for Age**

**Context ID 7456  
Units of Measure for Age**

**Type: Non-Extensible Version: 20020904**

<b>Coding Scheme Designator (0008,0102)</b>	<b>Coding Scheme Version (0008,0103)</b>	<b>Code Value (0008,0100)</b>	<b>Code Meaning (0008,0104)</b>
UCUM	1.4	a	year
UCUM	1.4	mo	month
UCUM	1.4	wk	week
UCUM	1.4	d	day
UCUM	1.4	h	hour
UCUM	1.4	min	minute

**CID 7460 Units of Linear Measurement**

**Context ID 7460  
Units of Linear Measurement**

**Type: Extensible Version: 20020904**

<b>Coding Scheme Designator (0008,0102)</b>	<b>Coding Scheme Version (0008,0103)</b>	<b>Code Value (0008,0100)</b>	<b>Code Meaning (0008,0104)</b>
UCUM	1.4	cm	centimeter
UCUM	1.4	mm	millimeter
UCUM	1.4	um	micrometer

**CID 7461 Units of Area Measurement**

**Context ID 7461  
Units of Area Measurement**

**Type: Extensible Version: 20020904**

<b>Coding Scheme Designator (0008,0102)</b>	<b>Coding Scheme Version (0008,0103)</b>	<b>Code Value (0008,0100)</b>	<b>Code Meaning (0008,0104)</b>
UCUM	1.4	cm2	Square centimeter
UCUM	1.4	mm2	Square millimeter
UCUM	1.4	um2	Square micrometer

**CID 7462 Units of Volume Measurement**

**Context ID 7462  
Units of Volume Measurement  
Type: Extensible Version: 20020904**

<b>Coding Scheme Designator (0008,0102)</b>	<b>Coding Scheme Version (0008,0103)</b>	<b>Code Value (0008,0100)</b>	<b>Code Meaning (0008,0104)</b>
UCUM	1.4	dm3	Cubic decimeter
UCUM	1.4	cm3	Cubic centimeter
UCUM	1.4	mm3	Cubic millimeter
UCUM	1.4	um3	Cubic micrometer

Note: A “cubic decimeter” is a “liter”, just as a “cubic centimeter” is a “milliliter” (of water). Though there are specific units “l” and “ml” in UCUM, only one form is included here, since this context group is intended for use for volume measurements of a physical object derived from one or more images, rather than of fluid volume.

**CID 7470 Linear Measurements**

**Context ID 7470  
Linear Measurements  
Type: Extensible Version: 20050822**

<b>Coding Scheme Designator (0008,0102)</b>	<b>Code Value (0008,0100)</b>	<b>Code Meaning (0008,0104)</b>
SRT	G-A22A	Length
DCM	121211	Path length
DCM	121206	Distance
SNM3	G-A220	Width
SRT	G-D785	Depth
SNM3	M-02550	Diameter
SNM3	G-A185	Long Axis
SNM3	G-A186	Short Axis
SRT	G-A193	Major Axis
SRT	G-A194	Minor Axis
SRT	G-A195	Perpendicular Axis
SNM3	G-A196	Radius
SRT	G-A197	Perimeter
SNM3	M-02560	Circumference
SRT	G-A198	Diameter of circumscribed circle
DCM	121207	Height

**CID 7471 Area Measurements**

**Context ID 7471  
Area Measurements**

**Type: Extensible Version: 20020904**

<b>Coding Scheme Designator (0008,0102)</b>	<b>Code Value (0008,0100)</b>	<b>Code Meaning (0008,0104)</b>
SNM3	G-A166	Area
SRT	G-A16A	Area of defined region

**CID 7472 Volume Measurements**

**Context ID 7472  
Volume Measurements**

**Type: Extensible Version: 20020904**

<b>Coding Scheme Designator (0008,0102)</b>	<b>Code Value (0008,0100)</b>	<b>Code Meaning (0008,0104)</b>
SNM3	G-D705	Volume
DCM	121216	Volume estimated from single 2D region
DCM	121218	Volume estimated from two non-coplanar 2D regions
DCM	121217	Volume estimated from three or more non-coplanar 2D regions
DCM	121222	Volume of sphere
DCM	121221	Volume of ellipsoid
DCM	121220	Volume of circumscribed sphere
DCM	121219	Volume of bounding three dimensional region

**CID 7480 Breed**

**Context ID 7480  
Breed**

**Type: Extensible Version: 20060822**

<b>Coding Scheme Designator (0008,0102)</b>	<b>Code Value (0008,0100)</b>	<b>Code Meaning (0008,0104)</b>
SRT	L-80139	Hereford cattle superbreed
SRT	L-8C338	Merino sheep superbreed
SRT	L-80121	Africander cattle breed
SRT	L-80122	Ankole cattle breed
SRT	L-80123	Ankole-Watusi cattle breed
SRT	L-80124	Baladicattle cattle breed



SRT	L-80125	Belmont Red cattle breed
SRT	L-80126	Bonsmara cattle breed
SRT	L-80127	Damietta cattle breed
SRT	L-80128	Horro cattle breed
SRT	L-80129	Kuri cattle breed
SRT	L-8012A	Nguni cattle breed
SRT	L-8012B	Philippine Native cattle breed
SRT	L-8012C	Romagnola cattle breed
SRT	L-8012E	Sanhe cattle breed
SRT	L-8012F	Tswana cattle breed
SRT	L-80138	Tuli cattle breed
SRT	L-8013A	Aliab Dinka cattle breed
SRT	L-8013B	Alur cattle breed
SRT	L-8013C	Ankina cattle breed
SRT	L-8013D	Apulian Podolian cattle breed
SRT	L-8013E	Arado cattle breed
SRT	L-8013F	Aweil Dinka cattle breed
SRT	L-8014C	Bahima cattle breed
SRT	L-8014D	Bapedi cattle breed
SRT	L-8014E	Baria (Vietnam/Madagascar) cattle breed
SRT	L-8014F	Barotse cattle breed
SRT	L-8015A	Barra do Cuanzo cattle breed
SRT	L-8015B	Bashi cattle breed
SRT	L-8015C	Basuto cattle breed
SRT	L-8015D	Batangas cattle breed
SRT	L-8015E	Bavenda cattle breed
SRT	L-8015F	Beja cattle breed
SRT	L-80161	Calabrian cattle breed
SRT	L-80162	Blonde-du Cap Bon cattle breed
SRT	L-80163	Cham-Doc cattle breed
SRT	L-80164	Chernigov cattle breed
SRT	L-80165	Chino Santandereano cattle breed
SRT	L-80166	Cinisara cattle breed
SRT	L-80167	Cuprem Hybrid cattle breed
SRT	L-80168	Dabieshan cattle breed
SRT	L-80169	Damara cattle breed
SRT	L-8016A	Danakil cattle breed
SRT	L-8016B	Dnieper cattle breed
SRT	L-8016C	Doayo cattle breed
SRT	L-8016D	Eastern Nuer cattle breed
SRT	L-8016E	Egyptian cattle breed

SRT	L-8016F	Fogera cattle breed
SRT	L-80177	Garfagnina cattle breed
SRT	L-80178	Grati cattle breed
SRT	L-80179	Gaunling cattle breed
SRT	L-8017A	Halhin Gol cattle breed
SRT	L-8017B	Holmonger cattle breed
SRT	L-8017C	Ilocos cattle breed
SRT	L-8017D	Iloilo cattle breed
SRT	L-8017E	Inkuku cattle breed
SRT	L-8017F	Iskar cattle breed
SRT	L-80180	Istrian cattle breed
SRT	L-80181	Javanese Ongole cattle breed
SRT	L-80182	Javanese Zebu cattle breed
SRT	L-80183	Jinnan cattle breed
SRT	L-80184	Kalmyk cattle breed
SRT	L-80185	Kaokoveld cattle breed
SRT	L-80186	Kazakh Whitehead cattle breed
SRT	L-80187	Kedah-Kelantan cattle breed
SRT	L-80188	Kigezi cattle breed
SRT	L-80189	Kisantu cattle breed
SRT	L-8018A	Kolubara cattle breed
SRT	L-8018B	Kurgan cattle breed
SRT	L-8018C	Kyoga cattle breed
SRT	L-8018D	Lucanian cattle breed
SRT	L-8018E	Maremmana cattle breed
SRT	L-8018F	Marianas cattle breed
SRT	L-80190	Maryuti cattle breed
SRT	L-80191	Mauritius Creole cattle breed
SRT	L-80192	Menufi cattle breed
SRT	L-80193	Mezzalina cattle breed
SRT	L-80194	Modicana cattle breed
SRT	L-80195	Moi cattle breed
SRT	L-80196	Nama cattle breed
SRT	L-80197	Nanyang cattle breed
SRT	L-80198	N'Dama Sanga cattle breed
SRT	L-80199	Nganda cattle breed
SRT	L-8019A	Nilotic Sanga cattle breed
SRT	L-8019B	Nkone cattle breed
SRT	L-8019C	North Malawi Angoni cattle breed
SRT	L-8019D	Nuer cattle breed
SRT	L-8019E	Nuras cattle breed

SRT	L-8019F	Nyoro cattle breed
SRT	L-801A0	Ovambo cattle breed
SRT	L-801A1	Pantelleria cattle breed
SRT	L-801A2	Pinzhou cattle breed
SRT	L-801A3	Porto Amboim cattle breed
SRT	L-801A4	Posavina cattle breed
SRT	L-801A5	Romanian Steppe cattle breed
SRT	L-801A6	Saidi cattle breed
SRT	L-801A7	Sardo-Modicana cattle breed
SRT	L-801A8	Sengologa cattle breed
SRT	L-801A9	Serere cattle breed
SRT	L-801AA	Seshaga cattle breed
SRT	L-801AB	Siberian Black Pied cattle breed
SRT	L-801AC	Socotra cattle breed
SRT	L-801AD	Southern Tswana cattle breed
SRT	L-801AE	Spreca cattle breed
SRT	L-801AF	Sunkuma cattle breed
SRT	L-801B0	Taiwan Zebu cattle breed
SRT	L-801B1	Thai cattle breed
SRT	L-801B2	Thailand Fighting Zebu cattle breed
SRT	L-801B3	Thanh-Hoa cattle breed
SRT	L-801B4	Tibetan cattle breed
SRT	L-801B5	Tonga cattle breed
SRT	L-801B6	Toro cattle breed
SRT	L-801B7	Tuni cattle breed
SRT	L-801B8	Turkish Gray Steppe cattle breed
SRT	L-801B9	Tuy-Hoa cattle breed
SRT	L-801BA	Ujumqin cattle breed
SRT	L-801BB	Abigar cattle breed
SRT	L-801BC	Africangnus cattle breed
SRT	L-801BD	Agerolese cattle breed
SRT	L-801BE	Albese cattle breed
SRT	L-801BF	Ukrainian Gray cattle breed
SRT	L-801C0	Vietnamese Yellow cattle breed
SRT	L-801C1	Watusi (USA) cattle breed
SRT	L-801C2	Wenshan cattle breed
SRT	L-801C3	Yakut cattle breed
SRT	L-801C4	Yunnan Zebu cattle breed
SRT	L-801C5	Zambia Angoni cattle breed
SRT	L-801C6	Drakensberger cattle breed
SRT	L-801C7	Modicana lowland cattle breed

SRT	L-801C8	Taiwan Yellow cattle breed
SRT	L-801C9	Menggu cattle breed
SRT	L-801CA	Albères cattlebreed
SRT	L-801CB	Alentejana cattlebreed
SRT	L-801CC	American White Park cattle breed
SRT	L-801CD	Amerifaxcattle breed
SRT	L-801CE	Anatolian Black cattle breed
SRT	L-801CF	Andalusian Black cattle breed
SRT	L-801D0	Andalusian Gray cattle breed
SRT	L-801D1	Angeln cattle breed
SRT	L-801D2	Asturian Mountain cattle breed
SRT	L-801D3	Asturian Valley cattle breed
SRT	L-801D4	Aubrac cattle breed
SRT	L-801D5	Aulie-Ata cattle breed
SRT	L-801D6	Australian Lowline cattle breed
SRT	L-801D7	Barzona cattle breed
SRT	L-801D8	Bazadais cattle breed
SRT	L-801D9	Beefmaker cattle breed
SRT	L-801DA	Belarus Red cattle breed
SRT	L-801DB	Belgian Blue cattle breed
SRT	L-801DC	Belgian Red cattle breed
SRT	L-801DD	Belmont Adaptaur cattle breed
SRT	L-801DE	Berrendas cattle breed
SRT	L-801DF	Blacksided Trondheim and Norland cattle breed
SRT	L-801E0	Blanco Orejinegro cattle breed
SRT	L-801E1	Braunvieh cattle breed
SRT	L-801E2	British White cattle breed
SRT	L-801E3	Cachena cattle breed
SRT	L-801E4	Canary Island cattle breed
SRT	L-801E5	Carinthian Blond cattle breed
SRT	L-801E6	Caucasian cattle breed
SRT	L-801E7	Charolais cattle breed
SRT	L-801EA	Chinese Black-and-White cattle breed
SRT	L-801EB	Corriente cattle breed
SRT	L-801EC	Costeño con Cuernos cattle breed
SRT	L-801ED	Damascus cattle breed
SRT	L-801EE	Danish Red cattle breed
SRT	L-801EF	Devon cattle breed
SRT	L-801F0	Dølafe cattle breed
SRT	L-801F1	Dutch Belted cattle breed

SRT	L-801F2	Dutch Friesian cattle breed
SRT	L-801F3	English Longhorn cattle breed
SRT	L-801F4	Estonian Red cattle breed
SRT	L-801F5	Evolène cattle breed
SRT	L-801F6	Fighting Bull cattle breed
SRT	L-801F7	Fjall cattle breed
SRT	L-801F8	Florida Cracker/Pineywoods cattle breed
SRT	L-801F9	Galician Blond cattle breed
SRT	L-801FA	Gascon cattle breed
SRT	L-801FB	German Red Pied cattle breed
SRT	L-801FC	Glan cattle breed
SRT	L-801FD	Gloucester cattle breed
SRT	L-801FE	Groningen Whiteheaded cattle breed
SRT	L-801FF	Hartón cattle breed
SRT	L-8031A	Bündner Oberland sheep breed
SRT	L-8031B	British Milk Sheep breed
SRT	L-8031C	Brillenschaf sheep breed
SRT	L-8031D	Brecknock Hill Cheviot sheep breed
SRT	L-8031E	Cholistani sheep breed
SRT	L-8031F	Bibrik sheep breed
SRT	L-8032A	Columbia sheep breed
SRT	L-8032B	Black Welsh Mountain Sheep breed
SRT	L-8032C	Blackhead Persian sheep breed
SRT	L-8032D	Bleu du Maine sheep breed
SRT	L-8032E	Bluefaced Leicester sheep breed
SRT	L-8032F	Bond sheep breed
SRT	L-8033A	Border Leicester sheep breed
SRT	L-8033B	Boreray sheep breed
SRT	L-8033C	Bovska sheep breed
SRT	L-8033D	Braunes Bergschaf sheep breed
SRT	L-8033E	Brazilian Somali sheep breed
SRT	L-8033F	Beulah Speckled-Face sheep breed
SRT	L-8034A	Dartmoor sheep breed
SRT	L-8034B	Fabrianese sheep breed
SRT	L-8034C	Exmoor Horn sheep breed
SRT	L-8034D	Elliottdale sheep breed
SRT	L-8034E	Drysdale sheep breed
SRT	L-8034F	Dorset Down sheep breed
SRT	L-80351	German Blackheaded Mutton sheep breed
SRT	L-80352	Kooka sheep breed
SRT	L-80353	Friesian Milk Sheep breed

SRT	L-80354	Gansu Alpine Fine-wool sheep breed
SRT	L-80355	German Whiteheaded Mutton sheep breed
SRT	L-80356	Graue Gehoernte Heidschnucke sheep breed
SRT	L-80357	Han sheep breed
SRT	L-80358	Gromark sheep breed
SRT	L-80359	Gulf Coast Native sheep breed
SRT	L-8035A	Dorper sheep breed
SRT	L-8035B	Devon Closewool sheep breed
SRT	L-8035C	Deutsches Blaukoepfiges Fleischschaf sheep breed
SRT	L-8035D	Derbyshire Gritstone sheep breed
SRT	L-8035E	Coburger Fuchsschaf sheep breed
SRT	L-8035F	Danish Landrace sheep breed
SRT	L-80360	Gute sheep breed
SRT	L-80361	Hampshire sheep breed
SRT	L-80362	Gentile di Puglia sheep breed
SRT	L-80363	German Mountain sheep breed
SRT	L-80364	Luzein sheep breed
SRT	L-80365	Katahdin sheep breed
SRT	L-80366	Leineschaf sheep breed
SRT	L-80367	Lincoln Longwool sheep breed
SRT	L-80368	Llanwenog sheep breed
SRT	L-80369	Lleyn sheep breed
SRT	L-8036A	Damara sheep breed
SRT	L-8036B	Damani sheep breed
SRT	L-8036C	Dalesbred sheep breed
SRT	L-8036D	Dala sheep breed
SRT	L-8036E	Criollo sheep breed
SRT	L-8036F	Cormo sheep breed
SRT	L-80370	Lati sheep breed
SRT	L-80371	Lonk sheep breed
SRT	L-80372	Langhe sheep breed
SRT	L-80373	Manx Loaghtan sheep breed
SRT	L-80374	Masai sheep breed
SRT	L-80375	Merinolandschaf sheep breed
SRT	L-80376	Lohi sheep breed
SRT	L-80377	Ile-de-France sheep breed
SRT	L-80378	Hasht Nagri sheep breed
SRT	L-80379	Hazaragie sheep breed
SRT	L-8037A	Coopworth sheep breed
SRT	L-8037B	Comisana sheep breed

SRT	L-8037C	Comeback sheep breed
SRT	L-8037D	Sicilian Barbary sheep breed
SRT	L-8037E	Africana sheep breed
SRT	L-8037F	Welsh Mountain Badger Faced sheep breed
SRT	L-80380	Hebridean sheep breed
SRT	L-80381	Heidschnucke sheep breed
SRT	L-80382	Herdwick sheep breed
SRT	L-80383	Hill Radnor sheep breed
SRT	L-80384	Icelandic sheep breed
SRT	L-80385	Harnai sheep breed
SRT	L-80386	Istrian Pramenka sheep breed
SRT	L-80387	Jacob sheep breed
SRT	L-80388	Jezerskosolcavska sheep breed
SRT	L-80389	Kachhi sheep breed
SRT	L-8038A	Wensleydale sheep breed
SRT	L-8038B	West African Dwarf sheep breed
SRT	L-8038C	White Suffolk sheep breed
SRT	L-8038D	Whiteface Dartmoor sheep breed
SRT	L-8038E	Whiteface Woodland sheep breed
SRT	L-8038F	Xinjiang Finewool sheep breed
SRT	L-80390	Kajli sheep breed
SRT	L-80391	Hog Island Sheep breed
SRT	L-80392	Biellese sheep breed
SRT	L-80393	Chios sheep breed
SRT	L-80394	Santa Cruz sheep breed
SRT	L-80395	Charollais sheep breed
SRT	L-80396	Castlemilk Moorit sheep breed
SRT	L-80397	Campanian Barbary sheep breed
SRT	L-80398	California Variegated Mutant sheep breed
SRT	L-80399	California Red sheep breed
SRT	L-8039A	Sopravissana sheep breed
SRT	L-8039B	Somali sheep breed
SRT	L-8039C	Welsh Hill Speckled Face sheep breed
SRT	L-8039D	Skudde sheep breed
SRT	L-8039E	Waziri sheep breed
SRT	L-8039F	Shetland sheep breed
SRT	L-80403	Cambridge sheep breed
SRT	L-80404	Solognote sheep breed
SRT	L-8040A	Colombian Criollo horse breed
SRT	L-8040B	Comtois horse breed
SRT	L-8040C	Corsican horse breed

SRT	L-8040D	Costa Rican Saddle Horse horse breed
SRT	L-8040E	Costeno horse breed
SRT	L-8040F	Cuban Paso horse breed
SRT	L-80420	Rough Fell sheep breed
SRT	L-8042D	Danish Warmblood horse breed
SRT	L-80432	Swaledale sheep breed
SRT	L-80434	Polypay sheep breed
SRT	L-80441	Pagliarola sheep breed
SRT	L-80442	Pomeranian Coarsewool sheep breed
SRT	L-80443	Sheep, Breed Undetermined sheep breed
SRT	L-80444	Orkney sheep breed
SRT	L-80445	Old Norwegian sheep breed
SRT	L-80446	Old Format Sheep breed
SRT	L-80447	Norwegian Fur sheep breed
SRT	L-80448	Norfolk Horn sheep breed
SRT	L-80449	Navajo-Churro sheep breed
SRT	L-80466	Racka sheep breed
SRT	L-80467	Rasa Aragonesa sheep breed
SRT	L-80468	Red Engadine sheep breed
SRT	L-80469	Rhoenschaf sheep breed
SRT	L-80470	Hucul horse breed
SRT	L-80471	AraAppaloosa horse breed
SRT	L-80472	Argentine Criollo horse breed
SRT	L-80473	Argentine Polo Pony horse breed
SRT	L-80474	Australian Pony horse breed
SRT	L-80475	Auxois horse breed
SRT	L-80476	Avelignese horse breed
SRT	L-80477	Azerbaijan horse breed
SRT	L-80478	Azores horse breed
SRT	L-80479	Bali horse breed
SRT	L-8047A	Balikus horse breed
SRT	L-8047B	Waziri horse breed
SRT	L-8047C	Banker Horse horse breed
SRT	L-8047D	Bardigiano horse breed
SRT	L-8047E	Batak horse breed
SRT	L-8047F	Bavarian Warmblood horse breed
SRT	L-80480	Belgian Ardennais horse breed
SRT	L-80481	Belgian Halfblood horse breed
SRT	L-80482	Belgian Warmblood horse breed
SRT	L-80483	Bhutia horse breed
SRT	L-80484	Black Sea Horse horse breed



SRT	L-80485	Bosnian horse breed
SRT	L-80486	Boulonnais horse breed
SRT	L-80487	Brandenburg horse breed
SRT	L-80488	Brazilian Sport Horse horse breed
SRT	L-80489	British Appaloosa horse breed
SRT	L-8048A	British Riding Pony horse breed
SRT	L-8048B	British Spotted Pony horse breed
SRT	L-8048C	Buohai horse breed
SRT	L-8048D	Buryat horse breed
SRT	L-8048E	Calabrian horse breed
SRT	L-8048F	Camargue horse breed
SRT	L-80490	Canadian Cutting Horse horse breed
SRT	L-80491	Canadian Rustic Pony horse breed
SRT	L-80492	Canadian Sport Horse horse breed
SRT	L-80493	Canik horse breed
SRT	L-80494	Cape Horse horse breed
SRT	L-80496	Cerbat horse breed
SRT	L-80497	Chakouyi horse breed
SRT	L-80498	Chara Horse horse breed
SRT	L-80499	Chickasaw horse breed
SRT	L-8049A	Chilote horse breed
SRT	L-8049B	Chinese Kazakh horse breed
SRT	L-8049C	Chinese Mongolian horse breed
SRT	L-8049D	Chumbivilcas horse breed
SRT	L-8049E	Chumysh horse breed
SRT	L-8049F	Cirit horse breed
SRT	L-804A1	Irish Draft horse breed
SRT	L-804A2	Irish Hunter horse breed
SRT	L-804A3	Cuban Trotter horse breed
SRT	L-804A4	Italian Heavy Draft horse breed
SRT	L-804A5	Jabe horse breed
SRT	L-804A6	Java horse breed
SRT	L-804A7	Vendéen sheep breed
SRT	L-804A8	Czech Warmblood horse breed
SRT	L-804A9	Jinhong horse breed
SRT	L-804AA	Jinzhou horse breed
SRT	L-804AC	Danubian horse breed
SRT	L-804AD	Karachai horse breed
SRT	L-804AE	Karakacan horse breed
SRT	L-804AF	Kathiawari horse breed
SRT	L-804B1	Ke-Er-Qin horse breed

SRT	L-804B2	Kirgiz horse breed
SRT	L-804B3	Kuznet horse breed
SRT	L-804B4	Landais horse breed
SRT	L-804B5	Lewitzer horse breed
SRT	L-804B6	Lichuan horse breed
SRT	L-804B7	Lijiang horse breed
SRT	L-804B8	Llanero horse breed
SRT	L-804B9	Lombok horse breed
SRT	L-804BA	Lundy Pony horse breed
SRT	L-804BB	Malakan horse breed
SRT	L-804BC	Malopolski horse breed
SRT	L-804BD	Datong horse breed
SRT	L-804BE	Mangalarga Paulista horse breed
SRT	L-804BF	Dulmen Pony horse breed
SRT	L-804C1	Maremmana horse breed
SRT	L-804C2	Marwari horse breed
SRT	L-804C3	Megezh horse breed
SRT	L-804C4	Megrel horse breed
SRT	L-804C5	Merens horse breed
SRT	L-804C6	Messara horse breed
SRT	L-804C7	Sumba horse breed
SRT	L-804C8	Sumbawa horse breed
SRT	L-804C9	Swedish Ardennes horse breed
SRT	L-804CA	Dutch Tuigpaard horse breed
SRT	L-804CB	East and Southeast Anadolu horse breed
SRT	L-804CC	Thai Pony horse breed
SRT	L-804CD	Thessalonian horse breed
SRT	L-804CE	Tibetan horse breed
SRT	L-804CF	Tieling horse breed
SRT	L-804D1	Timor horse breed
SRT	L-804D2	Trakya horse breed
SRT	L-804D3	Trote en Gallope horse breed
SRT	L-804D4	Turkoman horse breed
SRT	L-804D5	Tushin horse breed
SRT	L-804D6	Tuva horse breed
SRT	L-804D7	Uzunyayla horse breed
SRT	L-804D9	Voronezh Coach Horse horse breed
SRT	L-804DA	Elegant Warmblood horse breed
SRT	L-804DB	Welsh Cob horse breed
SRT	L-804DC	Welsh Mountain Pony horse breed
SRT	L-804DE	English Hack horse breed

SRT	L-804DF	Wurttemberg horse breed
SRT	L-804E1	Xilingol horse breed
SRT	L-804E2	Yanqi horse breed
SRT	L-804E3	Yemeni Horses horse breed
SRT	L-804E4	Yili horse breed
SRT	L-804E5	Yiwu horse breed
SRT	L-804E6	Yunnan horse breed
SRT	L-804E7	German Riding Pony horse breed
SRT	L-804E8	Guanzhong horse breed
SRT	L-804E9	Guizhou horse breed
SRT	L-804EA	Guoxia horse breed
SRT	L-804EB	Erlunchun horse breed
SRT	L-804EC	Half Saddlebred horse breed
SRT	L-804ED	Flores horse breed
SRT	L-804EE	Freiberg horse breed
SRT	L-804EF	Hessen horse breed
SRT	L-804F1	Hinis horse breed
SRT	L-804F2	Hirzai horse breed
SRT	L-804F3	Hungairan Coldblood horse breed
SRT	L-804F4	Hungarian Dun horse breed
SRT	L-804F5	Hungarian Sport Horse horse breed
SRT	L-804F6	International Striped Horse horse breed
SRT	L-804F7	Irish Cob horse breed
SRT	L-804F8	Mezen horse breed
SRT	L-804F9	Mezohegyes Sport Horse horse breed
SRT	L-804FA	French Cob horse breed
SRT	L-804FB	French Saddle pony horse breed
SRT	L-804FC	Murakoz horse breed
SRT	L-804FE	Finnhorse Draft horse breed
SRT	L-804FF	Mecklenburg horse breed
SRT	L-80504	Catalana chicken breed
SRT	L-80542	Haiti Creole pig breed
SRT	L-80543	Manor Hybrid pig breed
SRT	L-80544	Hamline pig breed
SRT	L-80545	Manor Ranger pig breed
SRT	L-80546	Manor Meishan pig breed
SRT	L-80547	Cotswold Gold pig breed
SRT	L-80548	Cotswold Platinum pig breed
SRT	L-80549	Cotswold 16 pig breed
SRT	L-8054A	Cotswold 29 pig breed
SRT	L-8054B	Cotswold 90 pig breed

SRT	L-8054C	Hampen pig breed
SRT	L-8054D	SPM pig breed
SRT	L-8054E	High Conformation White pig breed
SRT	L-8054F	Line 32 pig breed
SRT	L-80555	Line 21 pig breed
SRT	L-80556	Meatline pig breed
SRT	L-80557	Hampline pig breed
SRT	L-80558	Euroline pig breed
SRT	L-80559	Norline pig breed
SRT	L-8055A	Premier pig breed
SRT	L-8055B	Tribred pig breed
SRT	L-8055C	American Essex pig breed
SRT	L-8055D	Sino-Gascony pig breed
SRT	L-8055E	Guadeloupe Creole pig breed
SRT	L-8055F	Managra pig breed
SRT	L-8056A	Canadian Landrace pig breed
SRT	L-8056B	Canadian Yorkshire pig breed
SRT	L-8056C	Minnesota #4 pig breed
SRT	L-8056D	Pineywoods pig breed
SRT	L-8056E	Catalina Island pig breed
SRT	L-8056F	Ras-n-Lansa pig breed
SRT	L-8057B	Pitman-Moore Miniature pig breed
SRT	L-8057C	Vita Vet Lab Minipig pig breed
SRT	L-8057D	Hanford Miniature pig breed
SRT	L-8057E	Black Hampshire pig breed
SRT	L-8057F	Red Hamprace pig breed
SRT	L-80583	American Yorkshire pig breed
SRT	L-80584	American Berkshire pig breed
SRT	L-80585	Camborough Blue pig breed
SRT	L-80586	Camborough 12 pig breed
SRT	L-80587	Westrain pig breed
SRT	L-80588	Dalland 030 pig breed
SRT	L-80589	Razor-Back pig breed
SRT	L-8058A	Macau pig breed
SRT	L-8058B	Moura pig breed
SRT	L-8058C	Canastra pig breed
SRT	L-8058D	Pirapetinga pig breed
SRT	L-8058E	Piau pig breed
SRT	L-8058F	Nilo-Canastra pig breed
SRT	L-80595	Canastrão pig breed
SRT	L-80596	Canastrão, Junqueira pig breed

SRT	L-80597	Canastrão, Capitão Chico pig breed
SRT	L-80598	Canastrão, Zabumba pig breed
SRT	L-80599	Canastrão, Cabano pig breed
SRT	L-8059A	Canastrão, Vermelho pig breed
SRT	L-8059B	Piau, Caruncho Piau pig breed
SRT	L-8059C	Canastrinho pig breed
SRT	L-8059D	Honduras Switch-Tail pig breed
SRT	L-8059E	Mastergilt pig breed
SRT	L-8059F	Sovereign pig breed
SRT	L-805A1	Poltava pig breed
SRT	L-805A2	Lipetsk pig breed
SRT	L-805A3	Soviet Meat pig breed
SRT	L-805A4	Central Russian pig breed
SRT	L-805A5	Steppe Meat pig breed
SRT	L-805A6	Kharkov pig breed
SRT	L-805A7	Dnepropetrovsk pig breed
SRT	L-805A8	Russian Large White pig breed
SRT	L-805A9	Forest Mountain pig breed
SRT	L-805AA	Dnieper pig breed
SRT	L-805AB	Iberian pig breed
SRT	L-805AC	Iberian, Extremadura Red pig breed
SRT	L-805AD	Iberian, Jabugo Spotted pig breed
SRT	L-805AE	Iberian, Black Iberian pig breed
SRT	L-805AF	Philippine Native, Ilocos pig breed
SRT	L-805B1	Philippine Native, Jalajala pig breed
SRT	L-805B2	Mangalista pig breed
SRT	L-805B3	Alentejana pig breed
SRT	L-805B4	Belgian Landrace, BN pig breed
SRT	L-805B5	French Large White pig breed
SRT	L-805B6	Hyper Large White pig breed
SRT	L-805B7	Tia Meslan pig breed
SRT	L-805B8	Pen ar Lan 77 pig breed
SRT	L-805B9	Penshire pig breed
SRT	L-805BA	Laconie pig breed
SRT	L-805BB	Murcian pig breed
SRT	L-805BC	Cavallino pig breed
SRT	L-805BD	Calabrian pig breed
SRT	L-805BE	Apulian pig breed
SRT	L-805BF	Siena Belted pig breed
SRT	L-805C1	Calascibetta pig breed
SRT	L-805C2	Güssing Forest Pig pig breed

SRT	L-805C3	Swiss Edelschwein pig breed
SRT	L-805C4	North Caucasus pig breed
SRT	L-805C5	Don pig breed
SRT	L-805C6	Rostov pig breed
SRT	L-805C7	Russian Long-Eared White pig breed
SRT	L-805C8	Russian Short-Eared White pig breed
SRT	L-805C9	Prisheksninsk pig breed
SRT	L-805CA	Breitov pig breed
SRT	L-805CB	Livny pig breed
SRT	L-805CC	Tsivilsk pig breed
SRT	L-805CD	Urzhum pig breed
SRT	L-805CE	Minisib pig breed
SRT	L-805CF	Sakhalin White pig breed
SRT	L-805D0	North Siberian pig breed
SRT	L-805D1	Siberian Black Pied pig breed
SRT	L-805D2	Kemerovo pig breed
SRT	L-805D3	KM-1 pig breed
SRT	L-805D4	Aksaï Black Pied pig breed
SRT	L-805D5	Semirechensk pig breed
SRT	L-805D6	Min pig breed
SRT	L-805D7	Sanjiang White pig breed
SRT	L-805D8	Basque Black Pied pig breed
SRT	L-805D9	Corsican pig breed
SRT	L-805DA	Créole pig breed
SRT	L-805DB	Gascony pig breed
SRT	L-805DC	Limousin pig breed
SRT	L-805DD	Harbin White pig breed
SRT	L-805DE	Heilongjiang Spotted pig breed
SRT	L-805DF	Liaoning Black pig breed
SRT	L-805E1	Huang-Huai-Hai Black, Shenxian pig breed
SRT	L-805E2	Huang-Huai-Hai Black pig breed
SRT	L-805E3	Bamei pig breed
SRT	L-805E4	Hanjiang Black pig breed
SRT	L-805E5	Ding pig breed
SRT	L-805E6	Huai pig breed
SRT	L-805E7	New Huai pig breed
SRT	L-805E8	Mashen pig breed
SRT	L-805E9	Yimeng Black pig breed
SRT	L-805EB	Hetao Lop-Ear pig breed
SRT	L-805EC	Korean Native pig breed
SRT	L-805ED	Korean Improved pig breed

SRT	L-805EE	Penbuk pig breed
SRT	L-805EF	Beijing Black pig breed
SRT	L-805F1	Chenghua pig breed
SRT	L-805F2	Taoyuan pig breed
SRT	L-805F3	Taiwan Small Black pig breed
SRT	L-805F4	Taiwan Small Red pig breed
SRT	L-805F5	Guanling pig breed
SRT	L-805F6	Huchuan Mountain pig breed
SRT	L-805F7	Rongchang pig breed
SRT	L-805F8	Wujin pig breed
SRT	L-805F9	Dahe pig breed
SRT	L-805FA	Yanan pig breed
SRT	L-805FB	South Yunnan Short-Eared pig breed
SRT	L-805FC	Hainan, Lingao pig breed
SRT	L-805FD	Hainan, Tunchang pig breed
SRT	L-805FE	Hainan, Wenchang pig breed
SRT	L-805FF	Liang Guang Small Spotted pig breed
SRT	L-8060A	German Pasture pig breed
SRT	L-8060B	Piau, Sorocaba pig breed
SRT	L-8060C	Nilo pig breed
SRT	L-8060D	Bahia pig breed
SRT	L-8060E	Perna-Curta pig breed
SRT	L-8060F	Carunchinho pig breed
SRT	L-80613	Mandi pig breed
SRT	L-80614	Orehla de Colher pig breed
SRT	L-80615	Venezuelan Black pig breed
SRT	L-80616	Bolivian pig breed
SRT	L-80617	Pelón pig breed
SRT	L-80618	Mexican Wattled pig breed
SRT	L-80619	Dalland 080 pig breed
SRT	L-8061A	Sterling pig breed
SRT	L-8061B	Monarch pig breed
SRT	L-8061C	Bisaro pig breed
SRT	L-8061D	Black Hairless pig breed
SRT	L-8061E	Black Mangalitsa pig breed
SRT	L-8061F	Black Slavonian pig breed
SRT	L-80623	Borghigiana pig breed
SRT	L-80624	Chianina pig breed
SRT	L-80625	Cosentina pig breed
SRT	L-80626	Cuino pig breed
SRT	L-80627	Friuli Black pig breed

SRT	L-80628	Fumati pig breed
SRT	L-80629	Galician pig breed
SRT	L-8062A	German Berkshire pig breed
SRT	L-8062B	Ghori pig breed
SRT	L-8062C	Jianli pig breed
SRT	L-8062D	Lucanian pig breed
SRT	L-8062E	Maremmana pig breed
SRT	L-8062F	Miami pig breed
SRT	L-80634	Montmorillon pig breed
SRT	L-80635	Old Swedish Spotted pig breed
SRT	L-80636	Oliventina pig breed
SRT	L-80637	Parmense pig breed
SRT	L-80638	Romagnola pig breed
SRT	L-80639	Siberian pig breed
SRT	L-8063A	Small White pig breed
SRT	L-8063B	Baltaret pig breed
SRT	L-8063C	Tungchang pig breed
SRT	L-8063D	Sterling pig breed
SRT	L-8063E	Vich pig breed
SRT	L-8063F	Vietnamese pig breed
SRT	L-80645	Vitoria pig breed
SRT	L-80646	Wai Chow pig breed
SRT	L-80647	Yorkshire Blue and White pig breed
SRT	L-80648	Dalland 020 pig breed
SRT	L-80649	Wiltshire pig breed
SRT	L-8064A	Hamroc pig breed
SRT	L-8064B	DRU™ Terminals pig breed
SRT	L-8064C	Camborough 22 pig breed
SRT	L-8064D	Camborough 15 pig breed
SRT	L-8064E	PR 1050 pig breed
SRT	L-8064F	PR 1075 pig breed
SRT	L-8065A	Chryak PIC pig breed
SRT	L-8065B	Canadian Royal Blue pig breed
SRT	L-8065C	Line 500 Duroc pig breed
SRT	L-8065D	Bodmin 950 pig breed
SRT	L-8065E	Canadian Duroc pig breed
SRT	L-8065F	Canadian Hampshire pig breed
SRT	L-80664	Ba Xuyen pig breed
SRT	L-80665	Arapawa Island pig breed
SRT	L-80010	Wuzhishan pig breed
SRT	L-80667	Philippine Native pig breed



SRT	L-80668	Sinclair Miniature pig breed
SRT	L-80669	Saddleback pig breed
SRT	L-8066A	Yucatan Miniature pig breed
SRT	L-8066B	Bantu pig breed
SRT	L-8066C	Tibetan pig breed
SRT	L-8066D	Turopolje pig breed
SRT	L-8066E	Vietnamese Pot-Bellied Pig pig breed
SRT	L-8066F	American Landrace pig breed
SRT	L-80670	Swallow Belied Mangalitza pig breed
SRT	L-80671	Fengjing pig breed
SRT	L-80672	Finnish Landrace pig breed
SRT	L-80673	Guinea Hog pig breed
SRT	L-80674	Hezuo pig breed
SRT	L-80675	Ossabaw Island pig breed
SRT	L-80676	Kele pig breed
SRT	L-80677	Krskopolje pig breed
SRT	L-80678	Kunekune pig breed
SRT	L-80679	Large Black-White pig breed
SRT	L-8067A	Lithuanian Native pig breed
SRT	L-8067B	Meishan pig breed
SRT	L-8067C	Jinhua pig breed
SRT	L-8067D	Ningxiang pig breed
SRT	L-8067E	Mora Romagnola pig breed
SRT	L-8067F	Mukota pig breed
SRT	L-80680	Minzhu pig breed
SRT	L-80681	Neijiang pig breed
SRT	L-80682	Mulefoot pig breed
SRT	L-80683	Normand pig breed
SRT	L-80684	Angeln Saddleback pig breed
SRT	L-80685	Greek Local pig breed
SRT	L-80686	Icelandic pig breed
SRT	L-80687	Casertana pig breed
SRT	L-80688	Madonie-Sicilian pig breed
SRT	L-80689	Sardinian pig breed
SRT	L-8068A	Sicilian pig breed
SRT	L-8068B	Zlotniki Spotted pig breed
SRT	L-8068C	Zlotniki White pig breed
SRT	L-8068D	Siska pig breed
SRT	L-8068E	Sumadija pig breed
SRT	L-8068F	Froxfield Pygmy pig breed
SRT	L-80690	Danish Large White pig breed

SRT	L-80691	Danish Duroc pig breed
SRT	L-80692	Danish Hampshire pig breed
SRT	L-80693	Piggham pig breed
SRT	L-80694	New York Red pig breed
SRT	L-80695	Finnish Yorkshire pig breed
SRT	L-80696	Dutch Yorkshire pig breed
SRT	L-80697	Pulawy pig breed
SRT	L-80698	Pomeranian pig breed
SRT	L-80699	Polish Landrace pig breed
SRT	L-8069A	Estonian Bacon pig breed
SRT	L-8069B	Latvian White pig breed
SRT	L-8069C	Lithuanian White pig breed
SRT	L-8069D	BKB-1 pig breed
SRT	L-8069E	Belorus Black Pied pig breed
SRT	L-8069F	Mirgorod pig breed
SRT	L-806A1	Liang Guang Small Spotted, Luchuan pig breed
SRT	L-806A2	Fujian Small pig breed
SRT	L-806A3	North Fujian Black-and-White pig breed
SRT	L-806A4	Fuan Spotted pig breed
SRT	L-806A5	Putian pig breed
SRT	L-806A6	Fuzhou Black pig breed
SRT	L-806A7	Minbei Spotted pig breed
SRT	L-806A8	Lantang pig breed
SRT	L-806A9	Liang Guang Small Spotted, Guangdong Small Ear pig breed
SRT	L-806AA	Longlin pig breed
SRT	L-806AB	Yuedong Black pig breed
SRT	L-806AC	Xiang pig breed
SRT	L-806AD	Cantonese pig breed
SRT	L-806AE	Jinhua, Dongyang pig breed
SRT	L-806AF	Jinhua, Yongkang pig breed
SRT	L-806B1	Daweizi pig breed
SRT	L-806B2	Huazhong Two-End Black pig breed
SRT	L-806B3	Huazhong Two-End Black, Jianli pig breed
SRT	L-806B4	Huazhong Two-End Black, Tongcheng pig breed
SRT	L-806B5	Huazhong Two-End Black, Satzeling pig breed
SRT	L-806B6	Ganzhongnan Spotted pig breed
SRT	L-806B7	Hang pig breed
SRT	L-806B8	Leping pig breed
SRT	L-806B9	Longyou Black pig breed

SRT	L-806BA	Wuyi Black pig breed
SRT	L-806BB	Lee-Sung pig breed
SRT	L-806BC	Lan-Yu pig breed
SRT	L-806BD	Vietnamese Yorkshire pig breed
SRT	L-806BE	Yujiang pig breed
SRT	L-806BF	Wanzhe Spotted pig breed
SRT	L-806C1	Wanzhe Spotted, Chunan Spotted pig breed
SRT	L-806C2	Wanzhe Spotted, Wannan Spotted pig breed
SRT	L-806C3	Shengxian Spotted pig breed
SRT	L-806C4	Qingping pig breed
SRT	L-806C5	Xiangxi Black pig breed
SRT	L-806C6	Bamaxiang pig breed
SRT	L-806C7	Taihu pig breed
SRT	L-806C8	Erhulian pig breed
SRT	L-806C9	Jiaxing Black pig breed
SRT	L-806CA	Mi pig breed
SRT	L-806CB	Shahutou pig breed
SRT	L-806CC	Jiaoxi pig breed
SRT	L-806CD	Shanghai White pig breed
SRT	L-806CE	Hubei White pig breed
SRT	L-806CF	Xinjin pig breed
SRT	L-806D1	Xinjin, Jilin Black pig breed
SRT	L-806D2	Xinjin, Ning-an pig breed
SRT	L-806D3	Í pig breed
SRT	L-806D4	DBI pig breed
SRT	L-806D5	Xinjin, Xinjin pig breed
SRT	L-806D6	Meixin pig breed
SRT	L-806D7	North East China Spotted pig breed
SRT	L-806D8	Fannong Spotted pig breed
SRT	L-806D9	Laoshan pig breed
SRT	L-806DA	Nanjing Black pig breed
SRT	L-806DB	Shanxi Black pig breed
SRT	L-806DC	Ganzhou White pig breed
SRT	L-806DD	Guangxi White pig breed
SRT	L-806DE	Hanzhong White pig breed
SRT	L-806DF	Lutai White pig breed
SRT	L-806E1	Yili White pig breed
SRT	L-806E2	Xinjiang White pig breed
SRT	L-806E3	BSI pig breed
SRT	L-806E4	Mong Cai pig breed
SRT	L-806E5	Lang Hong pig breed

SRT	L-806E6	Muong Khuong pig breed
SRT	L-806E7	Meo pig breed
SRT	L-806E8	Tong Con pig breed
SRT	L-806E9	Ha Bac pig breed
SRT	L-806EA	Thai Binh pig breed
SRT	L-806EB	Co pig breed
SRT	L-806EC	Swiss Improved Landrace pig breed
SRT	L-806ED	German Landrace B pig breed
SRT	L-806EE	Edelschwein pig breed
SRT	L-806EF	Swabian-Hall pig breed
SRT	L-806F1	Bentheim Black Pied pig breed
SRT	L-806F2	Baldinger Spotted pig breed
SRT	L-806F3	German Red Pied pig breed
SRT	L-806F4	German Cornwall pig breed
SRT	L-806F5	Göttingen Miniature pig breed
SRT	L-806F6	Munich Miniature pig breed
SRT	L-806F8	Leicoma pig breed
SRT	L-806F9	Schwerfurt Meat pig breed
SRT	L-806FA	Hungarian White pig breed
SRT	L-806FB	Hungahyb pig breed
SRT	L-806FC	Bulgarian Native pig breed
SRT	L-806FD	East Balkan pig breed
SRT	L-806FE	Kula pig breed
SRT	L-806FF	Nghia Binh pig breed
SRT	L-807E1	Bizanian Hound dog breed
SRT	L-807E2	Bichon Teneriffe dog breed
SRT	L-807E3	Bizanian Hound dog breed
SRT	L-807E4	Bloodhound, St. Hubert dog breed
SRT	L-807E5	Bloodhound, Southern Hound dog breed
SRT	L-807E6	Bordeaux Dog breed
SRT	L-807E7	Brandlbracke dog breed
SRT	L-807E8	Braque d'Ariège dog breed
SRT	L-807E9	Portuguese Guard Dog breed
SRT	L-807EA	Great Münsterländer dog breed
SRT	L-807EB	Beagle, Smooth dog breed
SRT	L-807EC	Beagle, Rough dog breed
SRT	L-807ED	Belgian Griffon, Rough dog breed
SRT	L-807EE	Belgian Griffon, Smooth dog breed
SRT	L-807EF	Braque Belge dog breed
SRT	L-807F1	Belgian Street Dog breed
SRT	L-807F2	Bernese Hound dog breed

SRT	L-808A1	Eurasier dog breed
SRT	L-808A2	English Bulldog breed
SRT	L-808A3	Dogue de Bourdeaux dog breed
SRT	L-808A4	Kai Ken dog breed
SRT	L-808A5	Kui Mlk dog breed
SRT	L-808A6	Argentine Dogo dog breed
SRT	L-808A7	Alentejo herder dog breed
SRT	L-808A8	Saint Bernard, Long-haired dog breed
SRT	L-808A9	Saint Bernard, Short-haired dog breed
SRT	L-808AA	West Siberian Laika dog breed
SRT	L-808AB	Basset Fauve de Bretagne dog breed
SRT	L-808AC	Japanese Retriever dog breed
SRT	L-808AD	Kai Dog breed
SRT	L-808AE	American Blue Gascon Hound dog breed
SRT	L-808AF	Beagle Harrier dog breed
SRT	L-808B1	Kangal Dog breed
SRT	L-808B2	Leopard Cur dog breed
SRT	L-808B3	Patterdale Terrier dog breed
SRT	L-808B4	Petit Brabaçon dog breed
SRT	L-808B5	Aidi dog breed
SRT	L-808B6	American Indian Dog breed
SRT	L-808B7	Austrian Pinscher dog breed
SRT	L-808B8	American Eskimo, standard dog breed
SRT	L-808B9	American Eskimo, Miniature dog breed
SRT	L-808BA	American Eskimo, Toy dog breed
SRT	L-808BB	Basset Griffon Vendéen dog breed
SRT	L-808BC	Batard dog breed
SRT	L-808BD	Basset Bleu de Gascogne dog breed
SRT	L-808BE	Braque Dupuy dog breed
SRT	L-808BF	Bruno de Jura dog breed
SRT	L-808C1	Cão da Serra de Aires dog breed
SRT	L-808C2	Cão de Castro Laboreiro dog breed
SRT	L-808C3	Cão de Fila Miguel dog breed
SRT	L-808C4	Catalan Sheepdog breed
SRT	L-808C5	Caucasian Shepherd Dog breed
SRT	L-808C6	Cirneco dell'Etna dog breed
SRT	L-808C7	English Toy Terrier dog breed
SRT	L-808C8	German Spitz dog breed
SRT	L-808C9	Dingo dog breed
SRT	L-808CA	Fauve de Bretagne dog breed
SRT	L-808CB	Hellenic Hound dog breed

SRT	L-808CC	Holland Shepherd dog breed
SRT	L-808CD	Japanese Spitz dog breed
SRT	L-808CE	Jämthund dog breed
SRT	L-808CF	Jindo dog breed
SRT	L-808D1	Karelo-Finnish Laika dog breed
SRT	L-808D2	King Shepherd dog breed
SRT	L-808D3	Kishu dog breed
SRT	L-808D4	Kirhiz dog breed
SRT	L-808D5	Magyar Agár dog breed
SRT	L-808D6	Middle Asian Ovtcharka dog breed
SRT	L-808D7	Mi-Ki dog breed
SRT	L-808D8	Miniature Australian Shepherd dog breed
SRT	L-808D9	Min-pei dog breed
SRT	L-808DA	Mountain Cur dog breed
SRT	L-808DB	Moscow Longhaired Toy Terrier dog breed
SRT	L-808DC	Perdigueiro Portuguese dog breed
SRT	L-808DD	Podengo Canario dog breed
SRT	L-808DE	Podengo Pequeno dog breed
SRT	L-808DF	Pressa Mallorquin dog breed
SRT	L-808E1	Pyrenean Mastiff dog breed
SRT	L-808E2	Rastreador Brasileiro dog breed
SRT	L-808E3	Sabuesos Españoles dog breed
SRT	L-808E4	Schiller Hound dog breed
SRT	L-808E5	South Russian Steppe Hound dog breed
SRT	L-808E6	Styrian Mountain dog breed
SRT	L-808E7	Berger du Languedoc dog breed
SRT	L-808E8	Teddy Roosevelt Terrier dog breed
SRT	L-808E9	Transylvanian Hound dog breed
SRT	L-808EA	Trigg Hound dog breed
SRT	L-808EB	Tyrolean Hound dog breed
SRT	L-808EC	White Shepherd dog breed
SRT	L-808ED	Wirehair Styrian mountain dog breed
SRT	L-808EE	Yugoslavian Hound dog breed
SRT	L-808EF	Old Farm Collie dog breed
SRT	L-808F1	Old German Shepherd dog breed
SRT	L-808F2	New Zealand Heading Dog breed
SRT	L-808F3	German Koolie dog breed
SRT	L-808F4	Smithfield dog breed
SRT	L-808F5	Spanish Greyhound dog breed
SRT	L-808F6	Armant dog breed
SRT	L-808F8	Australian Greyhound dog breed

SRT	L-808F9	Australian Terrier, rough-coated dog breed
SRT	L-808FA	Australian Terrier, silky dog breed
SRT	L-808FB	Austrian Hound dog breed
SRT	L-808FC	Austrian Smooth-Haired Bracke dog breed
SRT	L-808FD	Balkan Hound dog breed
SRT	L-808FE	Banjara greyhound dog breed
SRT	L-808FF	Beagle, Standard dog breed
SRT	L-80916	Estrela Mountain Dog breed
SRT	L-80917	Epagneul Picard dog breed
SRT	L-80918	Epagneul Bleu de Picardie dog breed
SRT	L-80919	Estonian Hound dog breed
SRT	L-80920	Epagneul Pont-Audemer dog breed
SRT	L-80921	Eurasian dog breed
SRT	L-80922	Fell Terrier dog breed
SRT	L-80923	Fila Brasileiro dog breed
SRT	L-80924	Finnish Hound dog breed
SRT	L-80925	Finnish Lapphund dog breed
SRT	L-80926	Entlebucher dog breed
SRT	L-80927	French Guard Dog breed
SRT	L-80928	French Spaniel dog breed
SRT	L-80929	Coton de Tuléar dog breed
SRT	L-80930	Hamiltonstövare dog breed
SRT	L-80931	Danish Broholmer dog breed
SRT	L-80932	English Shepherd dog breed
SRT	L-80933	Drentse Patrijshond dog breed
SRT	L-80934	Dunker dog breed
SRT	L-80935	Dutch Kooiker Dog breed
SRT	L-80936	Dutch Shepherd dog breed
SRT	L-80937	East Siberian Laika dog breed
SRT	L-80938	Deutsche bracke dog breed
SRT	L-80939	Hanoverian Hound dog breed
SRT	L-80940	Hovawart dog breed
SRT	L-80941	Icelandic Sheepdog breed
SRT	L-80942	Inca Hairless Dog breed
SRT	L-80943	Irish Red and White Setter dog breed
SRT	L-80944	Jagdterrier dog breed
SRT	L-80945	German Spaniel dog breed
SRT	L-80946	Grand Anglo-Français dog breed
SRT	L-80947	Grand Basset Griffon Vendeen dog breed
SRT	L-80948	Grand Bleu de Gascogne dog breed
SRT	L-80949	Grand Gascon-Saintongeais dog breed

SRT	L-80950	German Pinscher dog breed
SRT	L-80951	Greater Swiss Mountain Dog breed
SRT	L-80952	Greenland Dog breed
SRT	L-80953	Griffon Fauve de Bretegne dog breed
SRT	L-80954	Griffon Nivernais dog breed
SRT	L-80955	Grand Griffon Vendéen dog breed
SRT	L-80956	Ainu dog breed
SRT	L-80957	Basset Artésien Normand dog breed
SRT	L-80958	Bavarian Mountain Hound dog breed
SRT	L-80959	Beauceron dog breed
SRT	L-80960	Azawakh dog breed
SRT	L-80961	Australian Shepherd dog breed
SRT	L-80962	Belgian Wolfhound dog breed
SRT	L-80963	Bergamasco dog breed
SRT	L-80964	Berger de Picard dog breed
SRT	L-80965	Berger de Pyrenees dog breed
SRT	L-80966	Billy dog breed
SRT	L-80967	Belgian Griffon dog breed
SRT	L-80968	American Hairless Terrier dog breed
SRT	L-80969	Beagle, Elizabethan dog breed
SRT	L-80970	Japanese Pointer dog breed
SRT	L-80971	Akbash dog breed
SRT	L-80972	Alapaha blueblood bulldog breed
SRT	L-80973	Barbet dog breed
SRT	L-80974	American Bulldog breed
SRT	L-80975	Black Russian Terrier dog breed
SRT	L-80976	Anglo-Français de moyen venerie dog breed
SRT	L-80977	Anglo-Français de petit venerie dog breed
SRT	L-80978	Appenzeller dog breed
SRT	L-80979	Ariégeois dog breed
SRT	L-80980	Alano Español dog breed
SRT	L-80981	Australian Kelpie dog breed
SRT	L-80982	Alpine dachsbracke dog breed
SRT	L-80983	Chien Français Blanc et Noir dog breed
SRT	L-80984	Carolina Dog breed
SRT	L-80985	Catahoula Leopard dog breed
SRT	L-80986	Caucasian Mountain Dog breed
SRT	L-80987	Cesky Fousek dog breed
SRT	L-80988	Cesky Terrier dog breed
SRT	L-80989	Chart Polski dog breed
SRT	L-80990	Black Forest Hound dog breed



SRT	L-80991	Chien d'Artois dog breed
SRT	L-80992	Canaan dog breed
SRT	L-80993	Chien Français Tricolore dog breed
SRT	L-80994	Chinese Crested dog breed
SRT	L-80995	Chinese Foo Dog breed
SRT	L-80996	Chinese Imperial ch'in dog breed
SRT	L-80997	Chinook dog breed
SRT	L-80998	Chien Français Blanc et Orange dog breed
SRT	L-80999	Braque Français de Grand Taille dog breed
SRT	L-809A1	Bolognese dog breed
SRT	L-809A2	Border Collie dog breed
SRT	L-809A3	Bracco Italiano dog breed
SRT	L-809A4	Cane Corso dog breed
SRT	L-809A5	Braque du Bourbonnais dog breed
SRT	L-809A6	Braque Français de Petite Taille dog breed
SRT	L-809A7	Braque Saint-Germain dog breed
SRT	L-809A8	Briquet Basset Griffon Vendeen dog breed
SRT	L-809A9	Black Mouth Cur dog breed
SRT	L-809AA	Braque d'Auvergne dog breed
SRT	L-809AB	Schapendoes dog breed
SRT	L-809AC	Sarplaninac dog breed
SRT	L-809AD	Russo-Laika dog breed
SRT	L-809AE	Bosnian Hound dog breed
SRT	L-809AF	Rat Terrier dog breed
SRT	L-809B1	Pumi dog breed
SRT	L-809B2	Presa Canario dog breed
SRT	L-809B3	Portuguese Pointer dog breed
SRT	L-809B4	Porcelaine dog breed
SRT	L-809B5	Shropshire Terrier dog breed
SRT	L-809B6	Boykin Spaniel dog breed
SRT	L-809B7	Southern Blackmouth Cur dog breed
SRT	L-809B8	South Russian Ovcharka dog breed
SRT	L-809B9	Small Spanish Hound dog breed
SRT	L-809BA	Small Münsterländer dog breed
SRT	L-809BB	Slovak Cuvak dog breed
SRT	L-809BC	Shiloh Shepherd dog breed
SRT	L-809BD	Shiba Inu dog breed
SRT	L-809BE	Welsh Sheepdog breed
SRT	L-809BF	Shar-pei dog breed
SRT	L-809C1	Sloughi dog breed
SRT	L-809C2	Owczarek Podhalanski dog breed

SRT	L-809C3	Norbottenspets dog breed
SRT	L-809C4	Norwegian Dunkerhound dog breed
SRT	L-809C5	Old Danish Bird Dog breed
SRT	L-809C6	Old Format Dachsund dog breed
SRT	L-809C7	Old Format Manchester Terrier dog breed
SRT	L-809C8	Old Format Min/Toy Poodle dog breed
SRT	L-809C9	Old Format Welsh Corgi dog breed
SRT	L-809CA	Neopolitan Mastiff dog breed
SRT	L-809CB	Perdiguero de Burgos dog breed
SRT	L-809CC	Perdiguero Navarro dog breed
SRT	L-809CD	Peruvian Inca Orchid dog breed
SRT	L-809CE	Petit Bleu de Gascogne dog breed
SRT	L-809CF	Petit Gascon-Saintongeais dog breed
SRT	L-809D1	Petit Griffon Bleu de Gascogne dog breed
SRT	L-809D2	Olde English Bulldogge dog breed
SRT	L-809D3	Lövchen dog breed
SRT	L-809D4	Polski Owczarek Nizinny dog breed
SRT	L-809D5	Polish Hound dog breed
SRT	L-809D6	Poitevin dog breed
SRT	L-809D7	Spanish Pointer dog breed
SRT	L-809D8	Kyi-Leo dog breed
SRT	L-809D9	Large Spanish Hound dog breed
SRT	L-809DA	Lundehund dog breed
SRT	L-809DB	Lurcher Hound dog breed
SRT	L-809DC	Maremma Sheepdogs dog breed
SRT	L-809DD	McNab dog breed
SRT	L-809DE	Miniature Bull Terrier dog breed
SRT	L-809DF	Mixed dog breed Dog breed
SRT	L-809E1	Mudi dog breed
SRT	L-809E2	Munster Lander Pointer dog breed
SRT	L-809E3	Loenberger dog breed
SRT	L-809E4	Chi Terrier dog breed
SRT	L-809E5	Krasky Ovcar dog breed
SRT	L-809E6	Kromfohländer dog breed
SRT	L-809E7	Havanese dog breed
SRT	L-809E8	American lamalese dog breed
SRT	L-809E9	Perro de Prensa Canario dog breed
SRT	L-809EA	Norwegian Lundehund dog breed
SRT	L-809EB	North American Shepherd dog breed
SRT	L-809EC	Kyi Apso dog breed
SRT	L-809ED	Swedish Lapphund dog breed

SRT	L-809EE	Treeing Tennessee Brindle dog breed
SRT	L-809EF	Telomain dog breed
SRT	L-809F1	Swedish Vallhund dog breed
SRT	L-809F2	Stumpy Tail Cattle Dog breed
SRT	L-809F3	Stabyhoun dog breed
SRT	L-809F4	Spinone Italiano dog breed
SRT	L-809F5	Spanish Mastiff dog breed
SRT	L-809F6	Berger Shetland dog breed
SRT	L-809F7	Thai Ridgeback dog breed
SRT	L-809F8	Swiss Mountain Dog breed
SRT	L-809F9	Tibetan Mastiff dog breed
SRT	L-809FA	Glen of Imaal Terrier dog breed
SRT	L-809FB	Tosa Inu dog breed
SRT	L-809FC	Toy Havanese Terrier dog breed
SRT	L-809FD	Treeing Cur dog breed
SRT	L-809FE	Treeing Feist dog breed
SRT	L-809FF	Greater Swiss Mountain Hound dog breed
SRT	L-80A70	Harlequin cat breed
SRT	L-80A71	Manxamese cat breed
SRT	L-80A73	Maltese cat breed
SRT	L-80A74	Mixed cat breed Cat cat breed
SRT	L-80A75	Ragdoll cat breed
SRT	L-80A76	Turkish van cat breed
SRT	L-80A77	British Blue cat breed
SRT	L-80A78	American Bobtail Shorthair cat breed
SRT	L-80A79	American Bobtail Longhair cat breed
SRT	L-80A80	American Curl cat breed
SRT	L-80A81	Australian Mist cat breed
SRT	L-80A83	Bengal cat breed
SRT	L-80A84	Brazilian Shorthair cat breed
SRT	L-80A85	California Spangled cat breed
SRT	L-80A86	Chantilly/Tiffany cat breed
SRT	L-80A87	Shorthair cat breed
SRT	L-80A88	German Rex cat breed
SRT	L-80A89	LaPerm Shorthair cat breed
SRT	L-80A90	LaPerm Longhair cat breed
SRT	L-80A91	Munchkin Shorthair cat breed
SRT	L-80A92	Munchkin Longhair cat breed
SRT	L-80A93	Nebelung cat breed
SRT	L-80A94	Norwegian Forest cat breed
SRT	L-80A95	Oriental Longhair cat breed

SRT	L-80A96	Pixiebob cat breed
SRT	L-80A97	Ragamuffin cat breed
SRT	L-80A99	Selkirk Rex cat breed
SRT	L-80AA1	Siberian cat breed
SRT	L-80AA2	Snowshoe cat breed
SRT	L-80AA3	Sokoke cat breed
SRT	L-80AA4	Sphynx cat breed
SRT	L-80B01	Bergamasca sheep breed
SRT	L-80B02	Portland sheep breed
SRT	L-80B03	Rideau Arcott sheep breed
SRT	L-80B04	Weisse Hornlose Heidschnucke sheep breed
SRT	L-80B05	Drents Heideschaap sheep breed
SRT	L-80B06	Kameroen sheep breed
SRT	L-80B07	Mergelland sheep breed
SRT	L-80B08	Ouessant sheep breed
SRT	L-80B09	Canadian Arcott sheep breed
SRT	L-80B10	Noordhollander sheep breed
SRT	L-80B17	Rijnlam-A sheep breed
SRT	L-80B18	Schoonebeker sheep breed
SRT	L-80B19	Wallis Blacknosed Sheep breed
SRT	L-80B22	Newfoundland sheep breed
SRT	L-80B23	Wallis Country Sheep breed
SRT	L-80B24	Rideau Arcott sheep breed
SRT	L-80B25	Tukidale sheep breed
SRT	L-80B26	Polwarth sheep breed
SRT	L-80B27	Ryeland sheep breed
SRT	L-80B2A	Thalli sheep breed
SRT	L-80B2B	Tong sheep breed
SRT	L-80B2C	Touabire sheep breed
SRT	L-80B2D	Tunis sheep breed
SRT	L-80B2E	Tyrol Mountain sheep breed
SRT	L-80B2F	Uda sheep breed
SRT	L-80B33	German Mutton Merino sheep breed
SRT	L-80B34	Medium-Wool Merino sheep breed
SRT	L-80B35	Fonthill Merino sheep breed
SRT	L-80B36	South African Mutton Merino sheep breed
SRT	L-80B37	Strong Wool Merino sheep breed
SRT	L-80B38	Poll Merino sheep breed
SRT	L-80B39	Fine Merino sheep breed
SRT	L-80B3A	South African Merino sheep breed
SRT	L-80B40	Superfine Merino sheep breed

SRT	L-80B47	Baden Wurttemberg horse breed
SRT	L-80B48	British Warmblood horse breed
SRT	L-80B49	Israeli horse breed
SRT	L-80B4A	French Ardennais horse breed
SRT	L-80B4B	Booroola Merino sheep breed
SRT	L-80B50	Cukurova horse breed
SRT	L-80B51	Czech Coldblood horse breed
SRT	L-80B52	Czechoslovakian Small Riding Horse horse breed
SRT	L-80B53	Jianchang horse breed
SRT	L-80B54	Jielin horse breed
SRT	L-80B55	Wielkopolski horse breed
SRT	L-80B56	Eleia horse breed
SRT	L-80B57	English Cob horse breed
SRT	L-80B58	Welsh Pony horse breed
SRT	L-80B59	Welsh Pony of Cob Type horse breed
SRT	L-80B5A	English Hunter horse breed
SRT	L-80B5B	Eriskay Pony horse breed
SRT	L-80B5C	Hackney Pony horse breed
SRT	L-80B5D	Estonian Draft horse breed
SRT	L-80B5E	Heihe horse breed
SRT	L-80B5F	Heilongkaing horse breed
SRT	L-80B65	Danish Sport Pony horse breed
SRT	L-80B66	Kabarda horse breed
SRT	L-80B67	Kalmyk horse breed
SRT	L-80B68	Mangalarga Marchador horse breed
SRT	L-80B69	Don horse breed
SRT	L-80B6A	Manipuri horse breed
SRT	L-80B6B	Swiss Warmblood horse breed
SRT	L-80B6C	Tavda horse breed
SRT	L-80B6D	East Bulgarian horse breed
SRT	L-80B6E	East Friesian (Old Type) horse breed
SRT	L-80B6F	East Friesian Warmblood (Modern Type) horse breed
SRT	L-80B70	Kakhetian pig breed
SRT	L-80B71	West French White pig breed
SRT	L-80B80	Miniature Hereford cattle breed
SRT	L-80B81	Jem-Jem Zebu cattle breed
SRT	L-80B82	Minusin horse breed
SRT	L-80B83	Morochocho horse breed
SRT	L-80B84	French Trotter horse breed
SRT	L-80B85	Furioso horse breed

SRT	L-80B86	Murghese horse breed
SRT	L-80B87	Mytilene horse breed
SRT	L-80B88	Namib Desert Horse horse breed
SRT	L-80B89	Danish Oldenborg horse breed
SRT	L-80B8A	Volynsk cattle breed
SRT	L-80B8B	Senepol cattle breed
SRT	L-80B8C	Shilluk cattle breed
SRT	L-80B8D	Sar Planina sheep breed
SRT	L-80B8E	Santa Inês sheep breed
SRT	L-80B8F	Sahel-type sheep breed
SRT	L-80B90	Rygja sheep breed
SRT	L-80B91	Rya sheep breed
SRT	L-80B92	Moghani sheep breed
SRT	L-80B93	Rouge de l'Quest sheep breed
SRT	L-80B94	Soay sheep breed
SRT	L-80B95	South Suffolk sheep breed
SRT	L-80B96	South Wales Mountain sheep breed
SRT	L-80B97	Spælsau sheep breed
SRT	L-80B98	Spiegel sheep breed
SRT	L-80B99	St. Croix sheep breed
SRT	L-80B9A	Steigar sheep breed
SRT	L-80B9B	Steinschaf sheep breed
SRT	L-80B9C	Welsh Mountain sheep breed
SRT	L-80B9D	Swedish Fur Sheep breed
SRT	L-80B9E	Teeswater sheep breed
SRT	L-80B9F	Texel sheep breed
SRT	L-80BA1	Pelibüey sheep breed
SRT	L-80BA2	Morada Nova sheep breed
SRT	L-80BA3	Balkhi sheep breed
SRT	L-80BA4	Bavarian Forest sheep breed
SRT	L-80BA5	Barbados Blackbelly sheep breed
SRT	L-80BA6	Romney sheep breed
SRT	L-80BA7	Awassi sheep breed
SRT	L-80BA8	Arapawa Island sheep breed
SRT	L-80BA9	Arabi sheep breed
SRT	L-80BB1	Apennine sheep breed
SRT	L-80BB2	American Tunis sheep breed
SRT	L-80BB3	Balwen Welsh Mountain sheep breed
SRT	L-80BB4	Priangan sheep breed
SRT	L-80BB5	Rabo Largo sheep breed
SRT	L-80BE6	Muban pig breed

SRT	L-80BE7	Iban pig breed
SRT	L-80BE8	Altay sheep breed
SRT	L-80BE9	Faeroes sheep breed
SRT	L-80BF6	Pitt Island sheep breed
SRT	L-80BF8	Pinzirita sheep breed
SRT	L-80BF9	Sardinian sheep breed
SRT	L-80C01	East Friesian sheep breed
SRT	L-80C02	Ujumqin sheep breed
SRT	L-80C22	DLS sheep breed
SRT	L-80C23	Walachenschaf sheep breed
SRT	L-80C24	Outaouais Arcott sheep breed
SRT	L-80C25	Ossimi sheep breed
SRT	L-80C29	Bentheimer Landschaf sheep breed
SRT	L-80C30	Barbado sheep breed
SRT	L-80C31	Baluchi sheep breed
SRT	L-86B36	Blanc de Bouscat rabbit breed
SRT	L-8A111	American Indian Horse horse breed
SRT	L-8A112	American Mustang horse breed
SRT	L-8A113	American Quarter Horse horse breed
SRT	L-8A115	American Shetland pony horse breed
SRT	L-8A116	Anadolu horse breed
SRT	L-8A117	Andean horse breed
SRT	L-8A118	Anglo-Kabarda horse breed
SRT	L-8A125	Narym horse breed
SRT	L-8A126	National Spotted Saddle Horse horse breed
SRT	L-8A127	Nigerian horse breed
SRT	L-8A128	North Swedish Trotter horse breed
SRT	L-8A129	Oriental Horse horse breed
SRT	L-8A12A	Rhineland Heavy Draft horse breed
SRT	L-8A12B	Romanian Saddle Horse horse breed
SRT	L-8A12C	Rottal horse breed
SRT	L-8A12D	Royal Canadian Mounted Police Horse horse breed
SRT	L-8A12E	Russian Saddle Horse horse breed
SRT	L-8A12F	Sable Island Horse horse breed
SRT	L-8A130	Panje horse breed
SRT	L-8A131	Patibarcina horse breed
SRT	L-8A132	Pechora horse breed
SRT	L-8A133	Peneia horse breed
SRT	L-8A134	Periangan horse breed
SRT	L-8A135	Persian Arab horse breed

SRT	L-8A136	Petiso Argentino horse breed
SRT	L-8A137	Polish Draft horse breed
SRT	L-8A138	Priob horse breed
SRT	L-8A139	Rahvan horse breed
SRT	L-8A13A	Salerno horse breed
SRT	L-8A13B	Sandalwood horse breed
SRT	L-8A13C	Sandan horse breed
SRT	L-8A13D	Pindos horse breed
SRT	L-8A13E	Piquira Pony horse breed
SRT	L-8A13F	Pleven horse breed
SRT	L-8A14A	Garrano tarpan horse X domestic horse breed
SRT	L-8A14B	Konink tarpan horse X domestic horse breed
SRT	L-8A14C	Asturian tarpan horse X domestic horse breed
SRT	L-8A14D	Pottok tarpan horse X domestic horse breed
SRT	L-8A150	Russian Trotter horse breed
SRT	L-8A151	West African Barb horse breed
SRT	L-8A152	Fell Pony horse breed
SRT	L-8A153	National Show Horse horse breed
SRT	L-8A154	Zhemaichu horse breed
SRT	L-8A155	Yonaguni horse breed
SRT	L-8A156	Yakut horse breed
SRT	L-8A157	Tawleed horse breed
SRT	L-8A158	Western Sudan Pony horse breed
SRT	L-8A159	Welera Pony horse breed
SRT	L-8A15A	Vyatka horse breed
SRT	L-8A15B	Vladimir Heavy Draft horse breed
SRT	L-8A15C	Vlaamperd horse breed
SRT	L-8A15D	Ukrainian Saddle Horse horse breed
SRT	L-8A15E	Tori horse breed
SRT	L-8A15F	Tokara horse breed
SRT	L-8A160	New Kirgiz horse breed
SRT	L-8A161	Oldenburg horse breed
SRT	L-8A162	Misaki horse breed
SRT	L-8A163	Miyako horse breed
SRT	L-8A164	Mongolian horse breed
SRT	L-8A165	Waler horse breed
SRT	L-8A166	Dutch Draft horse breed
SRT	L-8A167	Egyptian horse breed
SRT	L-8A168	Estonian Native horse breed
SRT	L-8A169	Exmoor Pony horse breed
SRT	L-8A16A	Faeroes Island Horse horse breed



SRT	L-8A16B	Falabella horse breed
SRT	L-8A16C	Dutch Warmblood horse breed
SRT	L-8A16D	Dongola horse breed
SRT	L-8A16E	Døle horse breed
SRT	L-8A16F	Djerma horse breed
SRT	L-8A170	Deliboz horse breed
SRT	L-8A171	Dartmoor Pony horse breed
SRT	L-8A172	Crioulo horse breed
SRT	L-8A173	Finnhorse horse breed
SRT	L-8A174	Sanfratello horse breed
SRT	L-8A175	Morab horse breed
SRT	L-8A176	Moyle horse breed
SRT	L-8A177	Mustang horse breed
SRT	L-8A178	M'Bayar horse breed
SRT	L-8A179	Lusitano horse breed
SRT	L-8A17A	Newfoundland Pony horse breed
SRT	L-8A17B	Noma horse breed
SRT	L-8A17C	Nooitgedacht Pony horse breed
SRT	L-8A17D	Nordland horse breed
SRT	L-8A17E	Noric horse breed
SRT	L-8A17F	North Swedish Horse horse breed
SRT	L-8A180	Northeastern horse breed
SRT	L-8A181	Kisber Felver horse breed
SRT	L-8A182	Anglo-Arab horse breed
SRT	L-8A183	Nonius horse breed
SRT	L-8A184	Nooitgedacht horse breed
SRT	L-8A185	Iomud horse breed
SRT	L-8A186	Jutland horse breed
SRT	L-8A187	Karabair horse breed
SRT	L-8A188	Karabakh horse breed
SRT	L-8A189	Kazakh horse breed
SRT	L-8A18A	Mangalarga horse breed
SRT	L-8A18B	Kirdi Pony horse breed
SRT	L-8A18C	Kiso horse breed
SRT	L-8A18D	Kladruby horse breed
SRT	L-8A18E	Knabstrup horse breed
SRT	L-8A18F	Kushum horse breed
SRT	L-8A190	Kustanai horse breed
SRT	L-8A191	Latvian horse breed
SRT	L-8A192	Lithuanian Heavy Draft horse breed
SRT	L-8A193	Lokai horse breed

SRT	L-8A194	Kiger Mustang horse breed
SRT	L-8A195	Pony of the Americas horse breed
SRT	L-8A196	Pintabian horse breed
SRT	L-8A197	Pantaneiro horse breed
SRT	L-8A198	Orlov Trotter horse breed
SRT	L-8A199	Northern Ardennais horse breed
SRT	L-8A19A	Abtenauer horse breed
SRT	L-8A19B	Adaev horse breed
SRT	L-8A19C	Albanian horse breed
SRT	L-8A19E	Alter Real horse breed
SRT	L-8A19F	American Bashkir Curly horse breed
SRT	L-8A1A1	Poitou Mule Producer horse breed
SRT	L-8A1A2	Polesian horse breed
SRT	L-8A1A3	Sardinian Anglo-Arab horse breed
SRT	L-8A1A4	Sardinian Pony horse breed
SRT	L-8A1A5	Sarvar horse breed
SRT	L-8A1A6	Schleswig horse breed
SRT	L-8A1A7	Schwarzwald Fuchse horse breed
SRT	L-8A1A8	Senne horse breed
SRT	L-8A1A9	Shan horse breed
SRT	L-8A1AA	Silesian horse breed
SRT	L-8A1AB	Sini horse breed
SRT	L-8A1AC	Skyros horse breed
SRT	L-8A1AD	Slovak Warmblood horse breed
SRT	L-8A1AE	Sokolka horse breed
SRT	L-8A1AF	South African Miniature horse breed
SRT	L-8A1B1	South German Coldblood horse breed
SRT	L-8A1B2	Southwest Spanish Mustang horse breed
SRT	L-8A1B4	Spanish-American Horse horse breed
SRT	L-8A1B5	Spanish Anglo-Arab horse breed
SRT	L-8A1B6	Spanish Colonial Horse horse breed
SRT	L-8A1B7	Spiti horse breed
SRT	L-8A1B8	Sulawesi horse breed
SRT	L-8A1B9	Criollo horse breed
SRT	L-8A1BA	Hequ horse breed
SRT	L-8A1BB	Connemara Pony horse breed
SRT	L-8A1BC	Colorado Ranger horse breed
SRT	L-8A1BD	Dales Pony horse breed
SRT	L-8A1BE	Gotland horse breed
SRT	L-8A1BF	Chincoteague Pony horse breed
SRT	L-8A1C1	Hokkaido horse breed

SRT	L-8A1C2	Highland Pony horse breed
SRT	L-8A1C3	Groningen horse breed
SRT	L-8A1C4	Cuban Pinto horse breed
SRT	L-8A1C5	Fleuve horse breed
SRT	L-8A1C6	Golden American Saddlebred horse breed
SRT	L-8A1C7	Gidran horse breed
SRT	L-8A1C8	Gelderland horse breed
SRT	L-8A1C9	Galician Pony horse breed
SRT	L-8A1CA	Friesian horse breed
SRT	L-8A1CB	Frederiksborg horse breed
SRT	L-8A1CC	Fouta horse breed
SRT	L-8A1CD	Florida Cracker horse breed
SRT	L-8A1CE	Guangxi horse breed
SRT	L-8A1CF	Ardennes horse breed
SRT	L-8A1D1	American Walking Pony horse breed
SRT	L-8A1D2	Azteca horse breed
SRT	L-8A1D3	American Cream Draft horse breed
SRT	L-8A1D4	Altai horse breed
SRT	L-8A1D5	Akhal-Teke horse breed
SRT	L-8A1D6	Abyssinian horse breed
SRT	L-8A1D7	Bhirum Pony horse breed
SRT	L-8A1D8	Cheju horse breed
SRT	L-8A1D9	Cayuse horse breed
SRT	L-8A1DA	Caspian horse breed
SRT	L-8A1DB	Carthusian horse breed
SRT	L-8A1DC	Campolina horse breed
SRT	L-8A1DD	Byelorussian Harness horse breed
SRT	L-8A1DE	Budyonny horse breed
SRT	L-8A1DF	Australian Brumby horse breed
SRT	L-8A1E1	Australian Stock Horse horse breed
SRT	L-8A1E2	Basuto Pony horse breed
SRT	L-8A1E3	Bashkir Curly horse breed
SRT	L-8A1E4	Bashkir horse breed
SRT	L-8A1E5	Barb horse breed
SRT	L-8A1E6	Ban-ei horse breed
SRT	L-8A1E7	Carpathian Pony horse breed
SRT	L-8A1E8	Baluchi horse breed
SRT	L-8A1E9	Balearic horse breed
SRT	L-8A1EA	Chilean Corralero horse breed
SRT	L-8A1EB	Breton horse breed
SRT	L-8A1EC	Taishuh horse breed

SRT	L-8A1ED	Swedish Warmblood horse breed
SRT	L-8A1EE	Sudan Country-Bred horse breed
SRT	L-8A1EF	Spanish-Norman horse breed
SRT	L-8A1F1	Spanish Barb horse breed
SRT	L-8A1F2	Soviet Heavy Draft horse breed
SRT	L-8A1F3	Sorraia horse breed
SRT	L-8A1F4	Somali Pony horse breed
SRT	L-8A1F5	Tersk horse breed
SRT	L-8A1F6	Shagya horse breed
SRT	L-8A1F7	Selle Francais horse breed
SRT	L-8A1F8	Sanhe horse breed
SRT	L-8A1FA	Russian Heavy Draft horse breed
SRT	L-8A1FB	Rocky Mountain Horse horse breed
SRT	L-8A1FC	Racking Horse horse breed
SRT	L-8A1FD	Quarter Pony horse breed
SRT	L-8A1FE	Quarab horse breed
SRT	L-8A1FF	Single-Footing Horse horse breed
SRT	L-8B105	Tuy Hoa Hairless pig breed
SRT	L-8B106	Hainan pig breed
SRT	L-8B107	Sino-Vietnamese pig breed
SRT	L-8B108	Bo Xu pig breed
SRT	L-8B109	Thuoc Nhieu pig breed
SRT	L-8B111	Burmese pig breed
SRT	L-8B112	Chin pig breed
SRT	L-8B113	Siamese pig breed
SRT	L-8B114	Hailum pig breed
SRT	L-8B115	Kwai pig breed
SRT	L-8B116	Raad pig breed
SRT	L-8B117	Akha pig breed
SRT	L-8B118	South China pig breed
SRT	L-8B119	South China Black pig breed
SRT	L-8B121	Balinese pig breed
SRT	L-8B122	Diani pig breed
SRT	L-8B123	Kaman pig breed
SRT	L-8B124	Ashanti Dwarf pig breed
SRT	L-8B125	Koronadal pig breed
SRT	L-8B126	Ohmini pig breed
SRT	L-8B127	Clawn pig breed
SRT	L-8B128	Inobuta (inter-species hybrid) pig breed
SRT	L-8B129	Kangaroo Island pig breed
SRT	L-8B130	Captain Cooker pig breed

SRT	L-8B131	West African pig breed
SRT	L-8B132	Nigerian pig breed
SRT	L-8B133	Bakosi pig breed
SRT	L-8B134	Windsnyer pig breed
SRT	L-8B135	Kolbroek pig breed
SRT	L-8B136	South African Landrace pig breed
SRT	L-8B137	Bulgarian White pig breed
SRT	L-8B139	Bulgarian Landrace pig breed
SRT	L-8B140	Danube White pig breed
SRT	L-8B141	Dermantsi Pied pig breed
SRT	L-8B142	Romanian Native, Stocli pig breed
SRT	L-8B143	Romanian Native, Baltaret pig breed
SRT	L-8B144	Banat White pig breed
SRT	L-8B145	Bazna pig breed
SRT	L-8B146	Dobrogea Black pig breed
SRT	L-8B147	Strei pig breed
SRT	L-8B148	Romanian Large White pig breed
SRT	L-8B149	Romanian Meat Pig pig breed
SRT	L-8B150	Gurktal pig breed
SRT	L-8B151	Black Slavonian pig breed
SRT	L-8B152	Resava pig breed
SRT	L-8B153	Morava pig breed
SRT	L-8B155	Dzumalia pig breed
SRT	L-8B156	Macedonian pig breed
SRT	L-8B157	Albanian Native pig breed
SRT	L-8B158	Shkodra pig breed
SRT	L-8B159	Slovenian White pig breed
SRT	L-8B160	Subotica White pig breed
SRT	L-8B161	Prestice pig breed
SRT	L-8B162	Slovakian Black Pied pig breed
SRT	L-8B163	Czech Improved White pig breed
SRT	L-8B164	Moravian Large Yorkshire pig breed
SRT	L-8B165	Slovakian White pig breed
SRT	L-8B166	Slovhyb-1 pig breed
SRT	L-8B167	Nitra Hybrid pig breed
SRT	L-8B168	Synthetic SL98 pig breed
SRT	L-8B169	SL96 pig breed
SRT	L-8B170	Czech Meat pig breed
SRT	L-8B171	Czech Miniature pig breed
SRT	L-8B172	Small Polish Prick-Eared pig breed
SRT	L-8B173	Polesian pig breed

SRT	L-8B174	Nad buzanska pig breed
SRT	L-8B175	Sarny pig breed
SRT	L-8B176	Krolevets pig breed
SRT	L-8B177	Polish Marsh pig breed
SRT	L-8B178	Large Polish Long-Eared pig breed
SRT	L-8B958	Herens cattle breed
SRT	L-8B959	Hinterwald cattle breed
SRT	L-8B95A	Hungarian Gray cattle breed
SRT	L-8B95B	Icelandic cattle breed
SRT	L-8B95C	Illawarra cattle breed
SRT	L-8B95D	Irish Moiled cattle breed
SRT	L-8B95E	Israeli Holstein cattle breed
SRT	L-8B95F	Istoben cattle breed
SRT	L-8B961	Jaulan cattle breed
SRT	L-8B962	Kazakh cattle breed
SRT	L-8B963	Kerry cattle breed
SRT	L-8B964	Kholmogory cattle breed
SRT	L-8B966	Latvian Brown cattle breed
SRT	L-8B967	Lincoln Red Shorthorn cattle breed
SRT	L-8B968	Lithuanian Red cattle breed
SRT	L-8B969	Mashona cattle breed
SRT	L-8B96A	Milking Devon cattle breed
SRT	L-8B96B	Mirandesa cattle breed
SRT	L-8B96C	Mixed dairy cattle breed
SRT	L-8B96D	Mongolian cattle breed
SRT	L-8B96E	Morucha cattle breed
SRT	L-8B96F	Kurdi cattle breed
SRT	L-8B971	N'dama cattle breed
SRT	L-8B972	Norwegian Red cattle breed
SRT	L-8B973	Parthenais cattle breed
SRT	L-8B974	Polish Red cattle breed
SRT	L-8B975	Rätien Gray cattle breed
SRT	L-8B976	Red and White cattle breed
SRT	L-8B977	Red Angus cattle breed
SRT	L-8B978	Red Polled Østland cattle breed
SRT	L-8B979	Red Steppe cattle breed
SRT	L-8B97A	Reggiana cattle breed
SRT	L-8B97B	Retinta cattle breed
SRT	L-8B97C	Romosinuano cattle breed
SRT	L-8B97D	Russian Black Pied cattle breed
SRT	L-8B97E	RX3 cattle breed

SRT	L-8B97F	Salorn cattle breed
SRT	L-8B983	Murboden cattle breed
SRT	L-8B984	San Martinero cattle breed
SRT	L-8B985	Sarabi cattle breed
SRT	L-8B987	Sharabi cattle breed
SRT	L-8B988	Shetland cattle breed
SRT	L-8B989	Simbrah cattle breed
SRT	L-8B98A	South Devon cattle breed
SRT	L-8B98B	Suffolk cattle breed
SRT	L-8B98C	Sussex cattle breed
SRT	L-8B98D	Swedish Red Polled cattle breed
SRT	L-8B98E	Telemark cattle breed
SRT	L-8B98F	Texas Longhorn cattle breed
SRT	L-8B990	Texon cattle breed
SRT	L-8B991	Vestland Fjord cattle breed
SRT	L-8B992	Vestland Red Polled cattle breed
SRT	L-8B993	Wagyu cattle breed
SRT	L-8B994	White Cáceres cattle breed
SRT	L-8B995	Xinjiang Brown cattle breed
SRT	L-8B996	Yanbian cattle breed
SRT	L-8B998	Zaobei cattle breed
SRT	L-8B999	Zavot cattle breed
SRT	L-8B99A	Znamensk cattle breed
SRT	L-8B99B	Alistana-Sanabresa cattle breed
SRT	L-8B99C	Andalusian Blond cattle breed
SRT	L-8B99D	Aosta Black Pied cattle breed
SRT	L-8B99E	Aosta Chestnut cattle breed
SRT	L-8B99F	Aosta Red Pied cattle breed
SRT	L-8B9A0	Aracena cattle breed
SRT	L-8B9A1	Argentine Friesian cattle breed
SRT	L-8B9A2	Armorican cattle breed
SRT	L-8B9A3	Arouquesa cattle breed
SRT	L-8B9A4	Aure et Saint-Girons cattle breed
SRT	L-8B9A5	Australian White cattle breed
SRT	L-8B9A6	Austrian Simmental cattle breed
SRT	L-8B9A7	Austrian Yellow cattle breed
SRT	L-8B9A8	Avetonou cattle breed
SRT	L-8B9A9	Avilena cattle breed
SRT	L-8B9AA	Avilena-Black Iberian cattle breed
SRT	L-8B9AB	Bakosi cattle breed
SRT	L-8B9AC	Bakwiri cattle breed

SRT	L-8B9AD	Baltic Black Pied cattle breed
SRT	L-8B9AE	Baoule cattle breed
SRT	L-8B9AF	Barrosa cattle breed
SRT	L-8B9B0	Barroso cattle breed
SRT	L-8B9B1	Bearnais cattle breed
SRT	L-8B9B2	Beef shorthorn cattle breed
SRT	L-8B9B3	Beef syntheticcattle breed
SRT	L-8B9B4	Beijing Black Pied cattle breed
SRT	L-8B9B5	Beiroa cattle breed
SRT	L-8B9B6	Belgian Black Pied Holsteincattle breed
SRT	L-8B9B7	Belgian Red Pied cattle breed
SRT	L-8B9B8	Belgian White and Red cattle breed
SRT	L-8B9B9	Belted Welsh cattle breed
SRT	L-8B9BA	Bestuzhev cattle breed
SRT	L-8B9BB	Betizuak cattle breed
SRT	L-8B9BC	Black Baldy cattle breed
SRT	L-8B9BD	Black Forrest cattle breed
SRT	L-8B9BE	Black Iberian cattle breed
SRT	L-8B9BF	Northern Blue cattle breed
SRT	L-8B9C0	Bragado do Sorraia cattle breed
SRT	L-8B9C1	Braganca cattle breed
SRT	L-8B9C2	Brandrood Ijsselvee cattle breed
SRT	L-8B9C3	Brazilian Polled cattle breed
SRT	L-8B9C4	Breton Black Pied cattle breed
SRT	L-8B9C5	Brown Atlas cattle breed
SRT	L-8B9C6	Bulgarian Brown cattle breed
SRT	L-8B9C7	Bulgarian Red cattle breed
SRT	L-8B9C8	Burlina cattle breed
SRT	L-8B9C9	Burwash cattle breed
SRT	L-8B9CA	Byelorussian Red cattle breed
SRT	L-8B9CB	Byelorussian Synthetic cattle breed
SRT	L-8B9CC	Cabannina cattle breed
SRT	L-8B9CD	Caldeano cattle breed
SRT	L-8B9CE	Caldelana cattle breed
SRT	L-8B9CF	Calvana cattle breed
SRT	L-8B9D0	Camargue cattle breed
SRT	L-8B9D1	Cambodian cattle breed
SRT	L-8B9D2	Caracu cattle breed
SRT	L-8B9D3	Carpathian Brown cattle breed
SRT	L-8B9D4	Casanareno cattle breed
SRT	L-8B9D5	Central Russian Black Pied cattle breed



SRT	L-8B9D6	Chaouia cattle breed
SRT	L-8B9D7	Charollandais cattle breed
SRT	L-8B9D8	Char-swiss cattle breed
SRT	L-8B9D9	Korean Black cattle breed
SRT	L-8B9DA	Chesi cattle breed
SRT	L-8B9DB	Cheurfa cattle breed
SRT	L-8B9DC	Chiford cattle breed
SRT	L-8B9DD	Chimaine cattle breed
SRT	L-8B9DE	Chinampo cattle breed
SRT	L-8B9DF	Cildir cattle breed
SRT	L-8B9E0	COOPELSO 93 cattle breed
SRT	L-8B9E1	Thrace cattle breed
SRT	L-8B9E2	Corsican cattle breed
SRT	L-8B9E3	Cretan Lowland cattle breed
SRT	L-8B9E4	Cretan Mountain cattle breed
SRT	L-8B9E5	Croatian Red cattle breed
SRT	L-8B9E6	Cukurova cattle breed
SRT	L-8B9E7	Curraleiro cattle breed
SRT	L-8B9E8	Cyprus cattle breed
SRT	L-8B9E9	Czech Pied cattle breed
SRT	L-8B9EA	Dagestan Mountain cattle breed
SRT	L-8B9EB	Dairy Shorthorn cattle breed
SRT	L-8B9EC	Dairy Synthetic cattle breed
SRT	L-8B9ED	Danish Red Pied cattle breed
SRT	L-8B9EE	Dengchuan cattle breed
SRT	L-8B9EF	Dexter-Kerry cattle breed
SRT	L-8B9F0	Doran cattle breed
SRT	L-8B9F1	Dorna cattle breed
SRT	L-8B9F2	Dortyol cattle breed
SRT	L-8B9F3	East Anatolian Red cattle breed
SRT	L-8B9F4	East Finnish cattle breed
SRT	L-8B9F5	East Macedonian cattle breed
SRT	L-8B9F6	Epirus cattle breed
SRT	L-8B9F7	Estonian Black Pied cattle breed
SRT	L-8B9FA	Ferrandais cattle breed
SRT	L-8B9FB	Finnish Ayrshire cattle breed
SRT	L-8B9FC	Flemish cattle breed
SRT	L-8B9FD	Red Flemish cattle breed
SRT	L-8B9FE	Fort Cross cattle breed
SRT	L-8B9FF	Fрати cattle breed
SRT	L-8BA00	Estonian Native cattle breed

SRT	L-8BA01	Faeroes cattle breed
SRT	L-8BA02	French Brown cattle breed
SRT	L-8BA03	Frijolillo cattle breed
SRT	L-8BA04	FRS cattle breed
SRT	L-8BA05	Gacko cattle breed
SRT	L-8BA06	Gado da Terra cattle breed
SRT	L-8BA07	Georgian Mountain cattle breed
SRT	L-8BA08	German Black Pied cattle breed
SRT	L-8BA09	German Black Pied Dairy cattle breed
SRT	L-8BA0A	Pechora cattle breed
SRT	L-8BA0B	Pee Wee cattle breed
SRT	L-8BA0C	Peloponnesus cattle breed
SRT	L-8BA0D	Pester cattle breed
SRT	L-8BA0E	Pie Rouge de l'Est cattle breed
SRT	L-8BA0F	Pisana cattle breed
SRT	L-8BA10	German Brown cattle breed
SRT	L-8BA11	German Shorthorn cattle breed
SRT	L-8BA12	Ghana Shorthorn cattle breed
SRT	L-8BA13	Glan-Donnersberg cattle breed
SRT	L-8BA14	Gole cattle breed
SRT	L-8BA15	Golpayegani cattle breed
SRT	L-8BA16	Gorbatov Red cattle breed
SRT	L-8BA17	Goryn cattle breed
SRT	L-8BA19	Greater Caucasus cattle breed
SRT	L-8BA1A	Polish Black and White Lowland cattle breed
SRT	L-8BA1B	Polish Simmental cattle breed
SRT	L-8BA1C	Polled Jersey cattle breed
SRT	L-8BA1D	Polled Lincoln Red cattle breed
SRT	L-8BA1E	Polled Shorthorn (US) cattle breed
SRT	L-8BA1F	Polled Simmental cattle breed
SRT	L-8BA20	Greek Shorthorn cattle breed
SRT	L-8BA21	Greek Steppe cattle breed
SRT	L-8BA22	Gray Alpine cattle breed
SRT	L-8BA23	Guadiana Spotted cattle breed
SRT	L-8BA24	Guelma cattle breed
SRT	L-8BA25	Harz Red cattle breed
SRT	L-8BA26	Hawaiian wild cattle breed
SRT	L-8BA27	Hereland cattle breed
SRT	L-8BA28	Holgus cattle breed
SRT	L-8BA29	Hrbinecky cattle breed
SRT	L-8BA2A	Polled Sussex cattle breed

SRT	L-8BA2B	Polled Welsh Black cattle breed
SRT	L-8BA2C	Pontremolese cattle breed
SRT	L-8BA2D	Preta cattle breed
SRT	L-8BA2E	Puerto Rican Criollo cattle breed
SRT	L-8BA2F	Pyrenean cattle breed
SRT	L-8BA30	Huertana cattle breed
SRT	L-8BA31	Hungarian Pied cattle breed
SRT	L-8BA32	Hungarofries cattle breed
SRT	L-8BA33	Improved Rodopi cattle breed
SRT	L-8BA34	INRA 95 cattle breed
SRT	L-8BA35	Italian Brown cattle breed
SRT	L-8BA36	Italian Red Pied cattle breed
SRT	L-8BA37	Japanese Black cattle breed
SRT	L-8BA38	Japanese Brown cattle breed
SRT	L-8BA39	Japanese Poll cattle breed
SRT	L-8BA3A	Qinchuan cattle breed
SRT	L-8BA3B	Ramo Grande cattle breed
SRT	L-8BA3C	Randall Lineback cattle breed
SRT	L-8BA3D	Red Galloway cattle breed
SRT	L-8BA3E	Regus cattle breed
SRT	L-8BA3F	Rendena cattle breed
SRT	L-8BA40	Japanese Shorthorn cattle breed
SRT	L-8BA41	Jarmelista cattle breed
SRT	L-8BA42	Kabyle cattle breed
SRT	L-8BA43	Kapsiki cattle breed
SRT	L-8BA44	Katerini cattle breed
SRT	L-8BA45	Kenran cattle breed
SRT	L-8BA46	Khevsurian cattle breed
SRT	L-8BA47	Kilis cattle breed
SRT	L-8BA48	Kochi cattle breed
SRT	L-8BA49	Korean Native cattle breed
SRT	L-8BA4A	Rhaetian Gray cattle breed
SRT	L-8BA4B	Rio Limon Dairy Criollo cattle breed
SRT	L-8BA4C	Rodopi cattle breed
SRT	L-8BA4D	Romanian Red cattle breed
SRT	L-8BA4E	Romanian Brown cattle breed
SRT	L-8BA4F	Russian Brown cattle breed
SRT	L-8BA50	Kostroma cattle breed
SRT	L-8BA51	Kravarsky cattle breed
SRT	L-8BA52	Kuchinoshima cattle breed
SRT	L-8BA53	Murray Gray cattle breed

SRT	L-8BA54	Australian Shorthorn cattle breed
SRT	L-8BA55	Kumamoto cattle breed
SRT	L-8BA56	Lagune cattle breed
SRT	L-8BA57	Lakenvelder cattle breed
SRT	L-8BA58	Latvian Blue Roan cattle breed
SRT	L-8BA59	La Velasquez cattle breed
SRT	L-8BA5A	Sardinian cattle breed
SRT	L-8BA5B	Sardinian brown cattle breed
SRT	L-8BA5C	Savinja Gray cattle breed
SRT	L-8BA5D	Sayaguesa cattle breed
SRT	L-8BA5E	Seferihisar cattle breed
SRT	L-8BA5F	Shkodra Red cattle breed
SRT	L-8BA60	Lebanese cattle breed
SRT	L-8BA61	Lebedin cattle breed
SRT	L-8BA62	Lesser Caucasus cattle breed
SRT	L-8BA63	Liberian Dwarf cattle breed
SRT	L-8BA64	Libyan cattle breed
SRT	L-8BA65	Lim cattle breed
SRT	L-8BA66	Limiana cattle breed
SRT	L-8BA67	Limpurger cattle breed
SRT	L-8BA68	Lobi cattle breed
SRT	L-8BA69	Lourdais cattle breed
SRT	L-8BA6A	Slovakian Pied cattle breed
SRT	L-8BA6B	Slovakian Pinzgau cattle breed
SRT	L-8BA6C	Slovenian Brown cattle breed
SRT	L-8BA6D	Somba cattle breed
SRT	L-8BA6E	South African Brown Swiss cattle breed
SRT	L-8BA6F	South Anatolian Red cattle breed
SRT	L-8BA70	Lucerna cattle breed
SRT	L-8BA71	Luxi cattle breed
SRT	L-8BA72	Macedonian Busa cattle breed
SRT	L-8BA73	Makaweli cattle breed
SRT	L-8BA74	Marinhoa cattle breed
SRT	L-8BA75	Maronesa cattle breed
SRT	L-8BA76	Mazury cattle breed
SRT	L-8BA77	Messaoria cattle breed
SRT	L-8BA78	Metohija Red cattle breed
SRT	L-8BA79	Mingrelian Red cattle breed
SRT	L-8BA7A	Southern Ukranian cattle breed
SRT	L-8BA7B	Spanish Brown Alpine cattle breed
SRT	L-8BA7C	Suksun cattle breed

SRT	L-8BA7D	Swiss Black Pied cattle breed
SRT	L-8BA7E	Sychevka cattle breed
SRT	L-8BA7F	Sykia cattle breed
SRT	L-8BA80	Minhota cattle breed
SRT	L-8BA81	Minorcan cattle breed
SRT	L-8BA82	Mishima cattle breed
SRT	L-8BA83	Modenese cattle breed
SRT	L-8BA84	Monchina cattle breed
SRT	L-8BA85	Montafon cattle breed
SRT	L-8BA86	Montbeliard cattle breed
SRT	L-8BA87	Morenas del Noroeste cattle breed
SRT	L-8BA88	Murcian cattle breed
SRT	L-8BA89	Murnau-Werdenfels cattle breed
SRT	L-8BA8A	Tagil cattle breed
SRT	L-8BA8B	Tajma cattle breed
SRT	L-8BA8C	Tambov Red cattle breed
SRT	L-8BA8D	Tarina cattle breed
SRT	L-8BA8E	Thessaly cattle breed
SRT	L-8BA8F	Tinima cattle breed
SRT	L-8BA90	Nantais cattle breed
SRT	L-8BA91	Nejdi cattle breed
SRT	L-8BA92	N'Gabou cattle breed
SRT	L-8BA93	North Finncattle cattle breed
SRT	L-8BA94	Oropa cattle breed
SRT	L-8BA95	Oulmes Blond cattle breed
SRT	L-8BA96	Pajuna cattle breed
SRT	L-8BA97	Palmera cattle breed
SRT	L-8BA98	Pankota Red cattle breed
SRT	L-8BA99	Paphos cattle breed
SRT	L-8BA9A	Tinos cattle breed
SRT	L-8BA9B	Transylvanian Pinzgua cattle breed
SRT	L-8BA9C	Tropical Dairy Cattle cattle breed
SRT	L-8BA9D	Tropicana cattle breed
SRT	L-8BA9E	Tudanca cattle breed
SRT	L-8BA9F	Turino cattle breed
SRT	L-8BAA0	Turkish Brown cattle breed
SRT	L-8BAA1	Tux-Zillertal cattle breed
SRT	L-8BAA2	Tyrol Gray cattle breed
SRT	L-8BAA3	Abondance cattle breed
SRT	L-8BAA4	Ala-Tau cattle breed
SRT	L-8BAA5	Albanian Illyrian cattle breed

SRT	L-8BAA6	Albanian Dwarf cattle breed
SRT	L-8BAA7	Ukrainian Whiteheaded cattle breed
SRT	L-8BAA8	Ural Black Pied cattle breed
SRT	L-8BAA9	Valdres cattle breed
SRT	L-8BAAA	Vaynol cattle breed
SRT	L-8BAAB	Verinesa cattle breed
SRT	L-8BAAC	Vianesa cattle breed
SRT	L-8BAAD	Villard-de-Lans cattle breed
SRT	L-8BAAE	Vogelsberg cattle breed
SRT	L-8BAAF	Pie Rouge des Plaines cattle breed
SRT	L-8BAB0	Vorderwald cattle breed
SRT	L-8BAB1	West African Dwarf Shorthorn cattle breed
SRT	L-8BAB2	West Finnish cattle breed
SRT	L-8BAB3	West Macedonian cattle breed
SRT	L-8BAB4	Whitebred Shorthorn cattle breed
SRT	L-8BAB5	White Galloway cattle breed
SRT	L-8BAB6	White Welsh cattle breed
SRT	L-8BAB7	Witrik cattle breed
SRT	L-8BAB8	Yacumento cattle breed
SRT	L-8BAB9	Yaroslavl cattle breed
SRT	L-8BABA	Yurino cattle breed
SRT	L-8BABB	Aleppo cattle breed
SRT	L-8BABC	Schwyz cattle breed
SRT	L-8BABD	Busa cattle breed
SRT	L-8BABE	Chiangus cattle breed
SRT	L-8BABF	Hallingdal cattle breed
SRT	L-8BAC0	Danish Jersey cattle breed
SRT	L-8BAC1	Enderby Island cattle breed
SRT	L-8BAC2	German Angus cattle breed
SRT	L-8BAC3	Israeli Red cattle breed
SRT	L-8BAC4	Lineback cattle breed
SRT	L-8BAC5	Mertolenga cattle breed
SRT	L-8BAC6	Red Friesian cattle breed
SRT	L-8BAC7	Senegus cattle breed
SRT	L-8BAC8	Southern Crioulo cattle breed
SRT	L-8BAC9	Vosges cattle breed
SRT	L-8BACA	Montanara cattle breed
SRT	L-8BACB	Almanzorena cattle breed
SRT	L-8BACC	Lorquina cattle breed
SRT	L-8BACD	Calasparrena cattle breed
SRT	L-8BACE	Amrit Mahal zebu cattle breed

SRT	L-8BACF	Bachaur cattle breed
SRT	L-8BAD0	Barka zebu cattle breed
SRT	L-8BAD1	Bengali cattle breed
SRT	L-8BAD2	Bhagnari cattle breed
SRT	L-8BAD3	Boran cattle breed
SRT	L-8BAD4	Channi cattle breed
SRT	L-8BAD5	Cholistani cattle breed
SRT	L-8BAD6	Dajal cattle breed
SRT	L-8BAD7	Dangi cattle breed
SRT	L-8BAD8	Deoni cattle breed
SRT	L-8BAD9	Dhanni cattle breed
SRT	L-8BADA	Gaolao cattle breed
SRT	L-8BADB	Hallikar cattle breed
SRT	L-8BADC	Hariana cattle breed
SRT	L-8BADD	Indo-Brazilian cattle breed
SRT	L-8BADE	Kangayam cattle breed
SRT	L-8BADF	Kankrej cattle breed
SRT	L-8BAE0	Kenkatha cattle breed
SRT	L-8BAE1	Kherigarh cattle breed
SRT	L-8BAE2	Khillari cattle breed
SRT	L-8BAE3	Krishna Valley cattle breed
SRT	L-8BAE4	Lohani cattle breed
SRT	L-8BAE5	Malvi cattle breed
SRT	L-8BAE6	Mewati cattle breed
SRT	L-8BAE7	Nagori cattle breed
SRT	L-8BAE9	Nelore cattle breed
SRT	L-8BAEA	Nimari cattle breed
SRT	L-8BAEB	Ponwar cattle breed
SRT	L-8BAEC	Rath cattle breed
SRT	L-8BAED	Rathi cattle breed
SRT	L-8BAEE	Red Sindhi cattle breed
SRT	L-8BAEF	Rojhan cattle breed
SRT	L-8BAF0	Sahiwal cattle breed
SRT	L-8BAF1	Siri zebu cattle breed
SRT	L-8BAF2	Tharparkar cattle breed
SRT	L-8BAF3	Zanzibar Zebu cattle breed
SRT	L-8BAF4	Arsi cattle breed
SRT	L-8BAF5	Atpadi Mahal cattle breed
SRT	L-8BAF6	Azaouak cattle breed
SRT	L-8BAF7	Azerbaijan Zebu cattle breed
SRT	L-8BAF8	Baggara cattle breed

SRT	L-8BAF9	Bambawa cattle breed
SRT	L-8BAFA	Bami cattle breed
SRT	L-8BAFB	Banyo cattle breed
SRT	L-8BAFC	Bargur cattle breed
SRT	L-8BAFD	Bari cattle breed
SRT	L-8BAFE	Bimal cattle breed
SRT	L-8BAFF	Borneo Zebu cattle breed
SRT	L-8BB00	Butana cattle breed
SRT	L-8BB01	Chittagong Red cattle breed
SRT	L-8BB02	Cutchi cattle breed
SRT	L-8BB03	Dairy Zebu of Uberaba cattle breed
SRT	L-8BB04	Dashtiari cattle breed
SRT	L-8BB05	Diali cattle breed
SRT	L-8BB06	Didinga cattle breed
SRT	L-8BB07	Dongola cattle breed
SRT	L-8BB09	Fellata cattle breed
SRT	L-8BB0A	Turkmen zebu cattle breed
SRT	L-8BB0B	Abyssinian Highland Zebu cattle breed
SRT	L-8BB0C	Abyssinian Shorthorned Zebu cattle breed
SRT	L-8BB0E	Aceh cattle breed
SRT	L-8BB0F	Achham cattle breed
SRT	L-8BB10	Garre cattle breed
SRT	L-8BB11	Gasara cattle breed
SRT	L-8BB12	Gobra cattle breed
SRT	L-8BB13	Goomsur cattle breed
SRT	L-8BB14	Gujamavu cattle breed
SRT	L-8BB15	Leiqiong cattle breed
SRT	L-8BB16	Hissar cattle breed
SRT	L-8BB17	Ingessana cattle breed
SRT	L-8BB18	Jamaica Brahman cattle breed
SRT	L-8BB19	Jellicut cattle breed
SRT	L-8BB1A	Adamawa cattle breed
SRT	L-8BB1B	Aden Zebu cattle breed
SRT	L-8BB1C	Afghan cattle breed
SRT	L-8BB1D	Alambadi cattle breed
SRT	L-8BB1E	Umblachery cattle breed
SRT	L-8BB1F	Venezuelan Zebu cattle breed
SRT	L-8BB20	Pantaneiro cattle breed
SRT	L-8BB21	Jenubi cattle breed
SRT	L-8BB22	Jiddu cattle breed
SRT	L-8BB23	Jijjiga Zebu cattle breed



SRT	L-8BB24	Kabota cattle breed
SRT	L-8BB25	Kachcha Siri cattle breed
SRT	L-8BB26	Kalakheri cattle breed
SRT	L-8BB27	Kamdhino cattle breed
SRT	L-8BB28	Kandahari cattle breed
SRT	L-8BB29	Kaningan cattle breed
SRT	L-8BB2A	Wakwa cattle breed
SRT	L-8BB2B	White Fulani cattle breed
SRT	L-8BB2C	Yemeni Zebu cattle breed
SRT	L-8BB2D	Iranian Zebu cattle breed
SRT	L-8BB2E	Khorsan cattle breed
SRT	L-8BB2F	Polled Gir cattle breed
SRT	L-8BB30	Kappiliyan cattle breed
SRT	L-8BB31	Karamajong cattle breed
SRT	L-8BB32	Kenana cattle breed
SRT	L-8BB33	Kenya Boran cattle breed
SRT	L-8BB34	Kenya Zebu cattle breed
SRT	L-8BB35	Khamala cattle breed
SRT	L-8BB36	Khurasani zebu cattle breed
SRT	L-8BB37	Kilara cattle breed
SRT	L-8BB38	Kinniya cattle breed
SRT	L-8BB39	Konari cattle breed
SRT	L-8BB3A	Guzerat cattle breed
SRT	L-8BB3B	Tadzhik zebu cattle breed
SRT	L-8BB3C	Deogir cattle breed
SRT	L-8BB3D	Gayal cattle breed
SRT	L-8BB3E	American bison X cattle breed
SRT	L-8BB3F	Australian Braford X zebu cattle breed
SRT	L-8BB40	Krishnagari cattle breed
SRT	L-8BB41	Kumauni cattle breed
SRT	L-8BB42	Ladakhi cattle breed
SRT	L-8BB43	Latuka cattle breed
SRT	L-8BB44	Lugware cattle breed
SRT	L-8BB45	Madagascar Zebu cattle breed
SRT	L-8BB46	Madaripur cattle breed
SRT	L-8BB47	Magal cattle breed
SRT	L-8BB48	Malawi Zebu cattle breed
SRT	L-8BB49	Malnad Gidda cattle breed
SRT	L-8BB4A	Australian Friesian Sahiwal X zebu cattle breed
SRT	L-8BB4B	Braford X zebu cattle breed
SRT	L-8BB4C	Brahmousin X zebu cattle breed

SRT	L-8BB4D	Canchim X zebu cattle breed
SRT	L-8BB4E	Charbray X zebu cattle breed
SRT	L-8BB4F	Droughtmaster X zebu cattle breed
SRT	L-8BB50	Mampati cattle breed
SRT	L-8BB51	Manapari cattle breed
SRT	L-8BB52	Maure cattle breed
SRT	L-8BB53	Mazandarani cattle breed
SRT	L-8BB54	Merauke cattle breed
SRT	L-8BB55	Mere cattle breed
SRT	L-8BB56	Mhaswad cattle breed
SRT	L-8BB57	Miniature Zebu cattle breed
SRT	L-8BB58	Mongalla cattle breed
SRT	L-8BB59	Morang cattle breed
SRT	L-8BB5A	Gelbray X zebu cattle breed
SRT	L-8BB5B	Jamaica Black X zebu cattle breed
SRT	L-8BB5C	Jamaica Hope X zebu cattle breed
SRT	L-8BB5D	Jamaica Red X zebu cattle breed
SRT	L-8BB5E	Karan Fries X zebu cattle breed
SRT	L-8BB5F	Karan Swiss X zebu cattle breed
SRT	L-8BB60	Mozambique Angoni cattle breed
SRT	L-8BB61	Mpwapwa cattle breed
SRT	L-8BB62	Murle cattle breed
SRT	L-8BB63	Nakali cattle breed
SRT	L-8BB64	Nepalese Hill Zebu cattle breed
SRT	L-8BB65	N'Gaoundere cattle breed
SRT	L-8BB66	Nkedi cattle breed
SRT	L-8BB67	North Bangladesh Gray cattle breed
SRT	L-8BB68	North Somali Zebu cattle breed
SRT	L-8BB69	Polled Guzerat cattle breed
SRT	L-8BB6A	Mandalong X zebu cattle breed
SRT	L-8BB6B	Australian Milking Zebu X zebu cattle breed
SRT	L-8BB6C	Red Brangus X zebu cattle breed
SRT	L-8BB6D	Santa Cruz X zebu cattle breed
SRT	L-8BB6E	Siboney X zebu cattle breed
SRT	L-8BB6F	Bambara X zebu cattle breed
SRT	L-8BB70	Polled Nelore cattle breed
SRT	L-8BB71	Prewakwa cattle breed
SRT	L-8BB72	Pul-M'bor cattle breed
SRT	L-8BB73	Punganur cattle breed
SRT	L-8BB74	Ramgarhi cattle breed
SRT	L-8BB75	Red Bororo cattle breed

SRT	L-8BB76	Red Desert cattle breed
SRT	L-8BB77	Red Kandhari cattle breed
SRT	L-8BB78	Shakhansurri cattle breed
SRT	L-8BB79	Sheko cattle breed
SRT	L-8BB7A	Bambey X zebu cattle breed
SRT	L-8BB7B	Batanes Black X zebu cattle breed
SRT	L-8BB7C	Borgou X zebu cattle breed
SRT	L-8BB7D	Brahorn X zebu cattle breed
SRT	L-8BB7E	Bralers X zebu cattle breed
SRT	L-8BB7F	Bra-Maine X zebu cattle breed
SRT	L-8BB80	Shendi cattle breed
SRT	L-8BB81	Shuwa cattle breed
SRT	L-8BB82	Sinhala cattle breed
SRT	L-8BB83	Sistani cattle breed
SRT	L-8BB84	Small East African Zebu cattle breed
SRT	L-8BB85	Sokoto Gudali cattle breed
SRT	L-8BB86	Somali cattle breed
SRT	L-8BB87	Sonkheri cattle breed
SRT	L-8BB88	Son Valley cattle breed
SRT	L-8BB89	South China Zebu cattle breed
SRT	L-8BB8A	Bra-Swiss X zebu cattle breed
SRT	L-8BB8B	Bravon X zebu cattle breed
SRT	L-8BB8C	Brazilian Dairy Hybrid X zebu cattle breed
SRT	L-8BB8D	Burmese X zebu cattle breed
SRT	L-8BB8E	Bushuev X zebu cattle breed
SRT	L-8BB8F	Caiua X zebu cattle breed
SRT	L-8BB90	South Malawi Zebu cattle breed
SRT	L-8BB91	Sudanese Fulani cattle breed
SRT	L-8BB92	Tabapua cattle breed
SRT	L-8BB93	Tamankaduwa cattle breed
SRT	L-8BB94	Tanzanian Zebu cattle breed
SRT	L-8BB95	Tarai cattle breed
SRT	L-8BB96	Thillari cattle breed
SRT	L-8BB97	Toposa cattle breed
SRT	L-8BB98	Toronke cattle breed
SRT	L-8BB99	Toupouri cattle breed
SRT	L-8BB9A	Carazebu X zebu cattle breed
SRT	L-8BB9B	Central Asian Zebu X zebu cattle breed
SRT	L-8BB9C	Charford X zebu cattle breed
SRT	L-8BB9D	Cuban Criollo X zebu cattle breed
SRT	L-8BB9E	Cuban Zebu X zebu cattle breed

SRT	L-8BB9F	Dishty X zebu cattle breed
SRT	L-8BC00	Djakore X zebu cattle breed
SRT	L-8BC01	Gambian N'Dama X zebu cattle breed
SRT	L-8BC03	Ghana Sanga X zebu cattle breed
SRT	L-8BC04	Girolando X zebu cattle breed
SRT	L-8BC05	Guzerando X zebu cattle breed
SRT	L-8BC06	Hatton X zebu cattle breed
SRT	L-8BC07	Ibage X zebu cattle breed
SRT	L-8BC08	Iraqi X zebu cattle breed
SRT	L-8BC09	Jerdi X zebu cattle breed
SRT	L-8BC10	Jersind X zebu cattle breed
SRT	L-8BC11	Jotko X zebu cattle breed
SRT	L-8BC12	Kanem X zebu cattle breed
SRT	L-8BC13	Keteku X zebu cattle breed
SRT	L-8BC14	Lavinia X zebu cattle breed
SRT	L-8BC15	Local Indian Dairy X zebu cattle breed
SRT	L-8BC16	Mantiqueira X zebu cattle breed
SRT	L-8BC17	Ndagu X zebu cattle breed
SRT	L-8BC18	Normanzu X zebu cattle breed
SRT	L-8BC19	Nuba Mountain X zebu cattle breed
SRT	L-8BC20	Pabna X zebu cattle breed
SRT	L-8BC21	Mixed Perijanero X zebu cattle breed
SRT	L-8BC22	Pitangueiras X zebu cattle breed
SRT	L-8BC23	Quasah X zebu cattle breed
SRT	L-8BC24	Rana X zebu cattle breed
SRT	L-8BC25	Ranger X zebu cattle breed
SRT	L-8BC26	Renitelo X zebu cattle breed
SRT	L-8BC27	Riopardenze X zebu cattle breed
SRT	L-8BC28	Rustaqi X zebu cattle breed
SRT	L-8BC29	Sabre X zebu cattle breed
SRT	L-8BC30	Sahford X zebu cattle breed
SRT	L-8BC31	Schwyz-Zeboid X zebu cattle breed
SRT	L-8BC32	Suia X zebu cattle breed
SRT	L-8BC33	Suisbu X zebu cattle breed
SRT	L-8BC34	Sunandini X zebu cattle breed
SRT	L-8BC35	Taino X zebu cattle breed
SRT	L-8BC36	Thibar X zebu cattle breed
SRT	L-8BC37	Toubou X zebu cattle breed
SRT	L-8BC38	Tropical X zebu cattle breed
SRT	L-8BC39	TSSH-1 X zebu cattle breed
SRT	L-8BC40	Victoria X zebu cattle breed

SRT	L-8BC41	Wokalup X zebu cattle breed
SRT	L-8BC42	Madura wild javan X zebu cattle breed
SRT	L-8BC43	Beefalo bison X cattle breed
SRT	L-8BC44	Beefalo bison X cattle breed
SRT	L-80A40	Rex cat breed
SRT	L-80770	Dachshund superbreed of dog
SRT	L-80320	Dorset sheep superbreed
SRT	L-80A42	Devon rex cat breed
SRT	L-80A41	Cornish rex cat breed
SRT	L-80A45	Oregon rex cat breed

**CID 7481 Breed Registry**

**Context ID 7481  
Breed Registry**

**Type: Extensible Version: 20060822**

<b>Coding Scheme Designator (0008,0102)</b>	<b>Code Value (0008,0100)</b>	<b>Code Meaning (0008,0104)</b>
DCM	109200	America Kennel Club
DCM	109201	America's Pet Registry Inc.
DCM	109202	American Canine Association
DCM	109203	American Purebred Registry
DCM	109204	American Rare Breed Association
DCM	109205	Animal Registry Unlimited
DCM	109206	Animal Research Foundation
DCM	109207	Canadian Border Collie Association
DCM	109208	Canadian Kennel Club
DCM	109209	Canadian Livestock Records Association
DCM	109210	Canine Federation of Canada
DCM	109211	Continental Kennel Club
DCM	109212	Dog Registry of America
DCM	109213	Federation of International Canines
DCM	109214	International Progressive Dog Breeders' Alliance
DCM	109215	National Kennel Club
DCM	109216	North American Purebred Dog Registry
DCM	109217	United All Breed Registry
DCM	109218	United Kennel Club
DCM	109219	Universal Kennel Club International
DCM	109220	Working Canine Association of Canada
DCM	109221	World Kennel Club
DCM	109222	World Wide Kennel Club

Note: The contents of this table were derived from the information available at <http://www.canadaguidetodogs.com/breedregistries.htm>.

**CID 9231 General Purpose Workitem Definition**

**Context ID 9231  
General Purpose Workitem Definition  
Type: Extensible Version: 20020904**

<b>Coding Scheme Designator (0008,0102)</b>	<b>Code Value (0008,0100)</b>	<b>Code Meaning (0008,0104)</b>
DCM	110001	Image Processing
DCM	110002	Quality Control
DCM	110003	Computer Aided Diagnosis
DCM	110004	Computer Aided Detection
DCM	110005	Interpretation
DCM	110006	Transcription
DCM	110007	Report Verification
DCM	110008	Print
DCM	110009	No subsequent Workitems
DCM	110013	Media Import

**CID 9232 Non-DICOM Output Types**

**Context ID 9232  
Non-DICOM Output Types  
Type: Extensible Version: 20020904**

<b>Coding Scheme Designator (0008,0102)</b>	<b>Code Value (0008,0100)</b>	<b>Code Meaning (0008,0104)</b>
DCM	110010	Film
DCM	110011	Dictation
DCM	110012	Transcription

**CID 9300 Procedure Discontinuation Reasons**

**Context ID 9300  
Procedure Discontinuation Reasons  
Type: Extensible Version: 20061024**

<b>Coding Scheme Designator (0008,0102)</b>	<b>Code Value (0008,0100)</b>	<b>Code Meaning (0008,0104)</b>
DCM	110500	Doctor cancelled procedure
DCM	110501	Equipment failure
DCM	110502	Incorrect procedure ordered
DCM	110503	Patient allergic to media/contrast

DCM	110504	Patient died
DCM	110505	Patient refused to continue procedure
DCM	110506	Patient taken for treatment or surgery
DCM	110507	Patient did not arrive
DCM	110508	Patient pregnant
DCM	110509	Change of procedure for correct charging
DCM	110510	Duplicate order
DCM	110511	Nursing unit cancel
DCM	110512	Incorrect side ordered
DCM	110513	Discontinued for unspecified reason
DCM	110514	Incorrect worklist entry selected
DCM	110515	Patient condition prevented continuing
DCM	110516	Equipment change
DCM	110521	Objects incorrectly formatted
DCM	110522	Object Types not supported
DCM	110523	Object Set incomplete
DCM	110524	Media Failure

**CID 10000 Scope of Accumulation**

**Context ID 10000  
Scope of Accumulation**

**Type: Extensible Version: 20051101**

<b>Coding Scheme Designator (0008,0102)</b>	<b>Code Value (0008,0100)</b>	<b>Code Meaning (0008,0104)</b>
DCM	113014	Study
DCM	113015	Series
DCM	113016	Performed Procedure Step

**CID 10001 UID Types**

**Context ID 10001  
UID Types**

**Type: Extensible Version: 20051101**

<b>Coding Scheme Designator (0008,0102)</b>	<b>Code Value (0008,0100)</b>	<b>Code Meaning (0008,0104)</b>
DCM	110180	Study Instance UID
DCM	112002	Series Instance UID
DCM	121126	Performed Procedure Step SOP Instance UID

**CID 10002 Irradiation Event Types**

**Context ID 10002  
Irradiation Event Types**

**Type: Extensible Version: 20051101**

<b>Coding Scheme Designator (0008,0102)</b>	<b>Code Value (0008,0100)</b>	<b>Code Meaning (0008,0104)</b>
SRT	P5-06000	Fluoroscopy
DCM	113611	Stationary Acquisition
DCM	113612	Stepping Acquisition
DCM	113613	Rotational Acquisition

**CID 10003 Equipment Plane Identification**

**Context ID 10003  
Equipment Plane Identification**

**Type: Extensible Version: 20051101**

<b>Coding Scheme Designator (0008,0102)</b>	<b>Code Value (0008,0100)</b>	<b>Code Meaning (0008,0104)</b>
DCM	113620	Plane A
DCM	113621	Plane B
DCM	113622	Single Plane

**CID 10004 Fluoro Modes**

**Context ID 10004  
Fluoro Modes**

**Type: Extensible Version: 20051101**

<b>Coding Scheme Designator (0008,0102)</b>	<b>Code Value (0008,0100)</b>	<b>Code Meaning (0008,0104)</b>
DCM	113630	Continuous
DCM	113631	Pulsed



**CID 10006 X-Ray Filter Materials**

**Context ID 10006  
X-Ray Filter Materials**

**Type: Extensible Version: 20051101**

<b>Coding Scheme Designator (0008,0102)</b>	<b>Code Value (0008,0100)</b>	<b>Code Meaning (0008,0104)</b>
SRT	C-150F9	Molybdenum or Molybdenum compound
SRT	C-120F9	Aluminum or Aluminum compound
SRT	C-127F9	Copper or Copper compound
SRT	C-167F9	Rhodium or Rhodium compound
DCM	113710	Niobium or Niobium compound
DCM	113711	Europium or Europium compound
SRT	C-132F9	Lead or Lead compound
SRT	C-156F9	Tantalum or Tantalum compound

**CID 10007 X-Ray Filter Types**

**Context ID 10007  
X-Ray Filter Types**

**Type: Extensible Version: 20051101**

<b>Coding Scheme Designator (0008,0102)</b>	<b>Code Value (0008,0100)</b>	<b>Code Meaning (0008,0104)</b>
DCM	113650	Strip filter
DCM	113651	Wedge filter
DCM	113652	Butterfly filter
DCM	111609	No Filter

**CID 10008 Dose Related Distance Measurements**

**Context ID 10008  
Dose Related Distance Measurements**

**Type: Extensible Version: 20051101**

<b>Coding Scheme Designator (0008,0102)</b>	<b>Code Value (0008,0100)</b>	<b>Code Meaning (0008,0104)</b>
DCM	113748	Distance Source to Isocenter
DCM	113737	Distance Source to Reference Point
DCM	113750	Distance Source to Detector
DCM	113751	Table Longitudinal Position
DCM	113752	Table Lateral Position

DCM	113753	Table Height Position
DCM	113792	Distance Source to Table Plane

**CID 10009 Measured/Calculated**

**Context ID 10009  
Measured/Calculated**

**Type: Extensible Version: 20051101**

<b>Coding Scheme Designator (0008,0102)</b>	<b>Code Value (0008,0100)</b>	<b>Code Meaning (0008,0104)</b>
SRT	R-41D41	Measured
SRT	R-41D2D	Calculated
SRT	R-10260	Estimated

**CID 10010 Dose Measurement Devices**

**Context ID 10010  
Dose Measurement Devices**

**Type: Extensible Version: 20051101**

<b>Coding Scheme Designator (0008,0102)</b>	<b>Code Value (0008,0100)</b>	<b>Code Meaning (0008,0104)</b>
SRT	A-2C090	Dosimeter

**CID 12001 Ultrasound Protocol Types**

**Context ID 12001  
Ultrasound Protocol Types**

**Type: Extensible Version: 20020904**

<b>Coding Scheme Designator (0008,0102)</b>	<b>Code Value (0008,0100)</b>	<b>Code Meaning (0008,0104)</b>
SNM3	P5-B3002	Transesophageal echocardiography
SNM3	P5-B3003	Transthoracic echocardiography
SNM3	P5-B3004	Epicardial echocardiography
SNM3	P5-B3005	Intravascular echocardiography
SNM3	P5-B3006	Intracardiac echocardiography
SNM3	P5-B301F	Limited M-mode only echocardiography
SNM3	P5-B303F	Limited Doppler only echocardiography
SNM3	P5-B3050	Exercise stress echocardiography
SNM3	P5-B3051	Maximal stress echocardiography
SNM3	P5-B3052	Submaximal stress echocardiography
SNM3	P5-B3053	Treadmill exercise stress echocardiography

SNM3	P5-B3054	Bruce treadmill stress echocardiography
SNM3	P5-B3055	Modified Bruce treadmill stress echocardiography
SNM3	P5-B3056	Naughton treadmill stress echocardiography
SNM3	P5-B3058	Bicycle exercise stress echocardiography
SNM3	P5-B3060	Echocardiography with administered drug stress
SNM3	P5-B3061	Dobutamine stress echocardiography
SNM3	P5-B3062	High dose dobutamine stress echocardiography
SNM3	P5-B3063	Low dose dobutamine stress echocardiography
SNM3	P5-B3065	Arbutamine stress echocardiography
SNM3	P5-B3066	Dipyridamole stress echocardiography
SNM3	P5-B3070	Cardiac pacing echocardiography
SNM3	P5-B3081	Adult echocardiography
SNM3	P5-B3082	Pediatric echocardiography
SNM3	P5-B3083	Intraoperative echocardiography
SNM3	P5-B3084	Upright echocardiography
SNM3	P5-B3085	Supine echocardiography
SNM3	P5-B3090	Contrast echocardiography
SNM3	P5-B3091	Contrast left ventricular opacification echocardiography
SNM3	P5-B3092	Contrast perfusion echocardiography
SNM3	P5-B3093	Contrast Doppler enhancement echocardiography
SNM3	P5-B3191	2D complete echocardiography
SNM3	P5-B3192	Limited 2D only echocardiography
SNM3	P5-B8215	Fetal echocardiography

**CID 12002      Ultrasound Protocol Stage Types**

**Context ID 12002  
Ultrasound Protocol Stage Types  
Type: Extensible Version: 20020904**

<b>Coding Scheme Designator (0008,0102)</b>	<b>Code Value (0008,0100)</b>	<b>Code Meaning (0008,0104)</b>
SNM3	P5-01000	Image acquisition procedure
SNM3	P5-01101	Image acquisition after administration of contrast agent
SNM3	P5-01103	Image acquisition during cardiac pacing
SNM3	P5-01104	Image acquisition at user-defined cardiac pacing rate
SNM3	P5-01111	Image acquisition during hand grip maneuver
SNM3	P5-01112	Image acquisition during Valsalva
SNM3	P5-01113	Image acquisition during postural maneuver
SNM3	P5-01120	Pre-procedure image acquisition
SNM3	P5-01121	Preoperative image acquisition

SNM3	P5-01130	Intra-procedure image acquisition
SNM3	P5-01131	Intra-operative image acquisition
SNM3	P5-01140	Post-procedure image acquisition
SNM3	P5-01141	Post-operative image acquisition
SNM3	P5-01142	Image acquisition following first cardiopulmonary bypass
SNM3	P5-01143	Image acquisition following second cardiopulmonary bypass
SNM3	P5-01144	Image acquisition following third cardiopulmonary bypass
SNM3	P5-01200	Image acquisition during stress procedure
SNM3	P5-01201	Image acquisition at baseline
SNM3	P5-01202	Pre-stress image acquisition
SNM3	P5-01203	Mid-stress image acquisition
SNM3	P5-01204	Peak-stress image acquisition
SNM3	P5-01205	Image acquisition during recovery
SNM3	P5-01300	Image acquisition after drug administration
SNM3	P5-01310	Image acquisition at user-defined dobutamine dose
SNM3	P5-01311	Image acquisition at low-dose dobutamine
SNM3	P5-01312	Image acquisition at mid-dose dobutamine
SNM3	P5-01313	Image acquisition at peak dose dobutamine
SNM3	P5-01314	Image acquisition at dobutamine 5 mcg/kg/min
SNM3	P5-01315	Image acquisition at dobutamine 10 mcg/kg/min
SNM3	P5-01316	Image acquisition at dobutamine 20 mcg/kg/min
SNM3	P5-01317	Image acquisition at dobutamine 30 mcg/kg/min
SNM3	P5-01318	Image acquisition at dobutamine 40 mcg/kg/min
SNM3	P5-01319	Image acquisition at dobutamine 50 mcg/kg/min
SNM3	P5-0131A	Image at dobutamine 40 mcg/kg/min plus atropine
SNM3	P5-0131B	Image acquisition at dobutamine 50 mcg/kg/min plus atropine
SNM3	P5-01323	Image acquisition at peak Arbutamine dose
SNM3	P5-01333	Image acquisition at peak dipyridamole
SNM3	P5-01341	Image acquisition after nitroglycerin
SNM3	P5-01342	Image acquisition after amyl nitrite
SNM3	P5-01343	Image acquisition after adenosine

**CID 12003 OB-GYN Dates**

**Context ID 12003**

**OB-GYN DATES**

**Type: Extensible**

**Version: 20030130**

<b>Coding Scheme Designator (0008,0102)</b>	<b>Code Value (0008,0100)</b>	<b>Code Meaning (0008,0104)</b>
LN	11778-8	EDD
LN	11779-6	EDD from LMP
LN	11781-2	EDD from average ultrasound age
LN	11780-4	EDD from ovulation date
LN	11955-2	LMP
LN	33066-2	Estimated LMP by EDD
LN	11976-8	Ovulation date
LN	33067-0	Conception Date

**CID 12004 Fetal Biometry Ratios**

**Context ID 12004**

**Fetal Biometry Ratios**

**Type: Extensible**

**Version: 20030130**

<b>Coding Scheme Designator (0008,0102)</b>	<b>Code Value (0008,0100)</b>	<b>Code Meaning (0008,0104)</b>
LN	11947-9	HC/AC
LN	11871-1	FL/AC
LN	11872-9	FL/BPD
LN	11823-2	Cephalic Index
LN	11873-7	FL/HC

**CID 12005 Fetal Biometry Measurements**

**Context ID 12005**

**Fetal Biometry Measurements**

**Type: Extensible**

**Version: 20030130**

<b>Coding Scheme Designator (0008,0102)</b>	<b>Code Value (0008,0100)</b>	<b>Code Meaning (0008,0104)</b>
LN	11979-2	Abdominal Circumference
LN	11818-2	Anterior-Posterior Abdominal Diameter
LN	11819-0	Anterior-Posterior Trunk Diameter
LN	11820-8	Biparietal Diameter
LN	11824-0	BPD area corrected

LN	11860-4	Cisterna Magna
LN	11963-6	Femur Length
LN	11965-1	Foot length
LN	11984-2	Head Circumference
LN	11851-3	Occipital-Frontal Diameter
LN	11988-3	Thoracic Circumference
LN	33068-8	Thoracic Area
LN	11862-0	Transverse Abdominal Diameter
LN	11863-8	Trans Cerebellar Diameter
LN	11864-6	Transverse Thoracic Diameter
LN	11853-9	Left Kidney thickness
LN	11834-9	Left Kidney length
LN	11825-7	Left Kidney width
LN	11855-4	Right Kidney thickness
LN	11836-4	Right Kidney length
LN	11827-3	Right Kidney width
LN	33191-8	APAD * TAD

**CID 12006 Fetal Long Bones Biometry Measurements**

**Context ID 12006**

**Fetal Long Bones Measurements**

**Type: Extensible**

**Version: 20030130**

<b>Coding Scheme Designator (0008,0102)</b>	<b>Code Value (0008,0100)</b>	<b>Code Meaning (0008,0104)</b>
LN	11966-9	Humerus length
LN	11967-7	Radius length
LN	11969-3	Ulna length
LN	11968-5	Tibia length
LN	11964-4	Fibula length
LN	11962-8	Clavicle length
LN	11963-6	Femur Length

**CID 12007 Fetal Cranium**

**Context ID 12007**

**Fetal Cranium**

**Type: Extensible**

**Version: 20030130**

<b>Coding Scheme Designator (0008,0102)</b>	<b>Code Value (0008,0100)</b>	<b>Code Meaning (0008,0104)</b>
LN	12171-5	Lateral Ventricular width
LN	11860-4	Cisterna Magna length

LN	12146-7	Nuchal Fold thickness
LN	33070-4	Inner Orbital Diameter
LN	11629-3	Outer Orbital Diameter
LN	11863-8	Trans Cerebellar Diameter
LN	33069-6	Nuchal Translucency
LN	33197-5	Anterior Horn Lateral ventricular width
LN	33196-7	Posterior Horn Lateral ventricular width
LN	12170-7	Width of Hemisphere

**CID 12008 OB-GYN Amniotic Sac**

**Context ID 12008**

**OB-GYN Amniotic Sac**

**Type: Extensible**

**Version: 20030130**

<b>Coding Scheme Designator (0008,0102)</b>	<b>Code Value (0008,0100)</b>	<b>Code Meaning (0008,0104)</b>
LN	11624-4	First Quadrant Diameter
LN	11626-9	Second Quadrant Diameter
LN	11625-1	Third Quadrant Diameter
LN	11623-6	Fourth Quadrant Diameter
SRT	M-02550	Diameter

**CID 12009 Early Gestation Biometry Measurements**

**Context ID 12009**

**Early Gestation Biometry Measurements**

**Type: Extensible**

**Version: 20030130**

<b>Coding Scheme Designator (0008,0102)</b>	<b>Code Value (0008,0100)</b>	<b>Code Meaning (0008,0104)</b>
LN	11957-8	Crown Rump Length
LN	11850-5	Gestational Sac Diameter
LN	33071-2	Spine Length
LN	11816-6	Yolk Sac length
LN	33069-6	Nuchal Translucency

**CID 12011 Ultrasound Pelvis and Uterus**

**Context ID 12011**

**Ultrasound Pelvis and Uterus**

**Type: Extensible**

**Version: 20030130**

<b>Coding Scheme Designator</b>	<b>Code Value (0008,0100)</b>	<b>Code Meaning (0008,0104)</b>
---------------------------------	-------------------------------	---------------------------------

<b>(0008,0102)</b>		
LN	11961-0	Cervix Length
LN	12145-9	Endometrium Thickness

**CID 12012 OB Equations and Tables**

**Context ID 12012**

**OB Equations and Tables**

**Type: Extensible**

**Version: 20030130**

<b>Coding Scheme Designator (0008,0102)</b>	<b>Code Value (0008,0100)</b>	<b>Code Meaning (0008,0104)</b>
		INCLUDE CID 12013 Gestational Age Equations and Tables
		INCLUDE CID 12014 OB Fetal Body Weight Equations and Tables
		INCLUDE CID 12015 Fetal Growth Equations and Tables
		INCLUDE CID 12016 Estimated Fetal Weight Percentile Equations and Tables

**CID 12013 Gestational Age Equations and Tables**

These terms define a functional relationship of the gestational age from a biometric measurement.

**Context Group 12013**

**Gestational Age Equations and Tables**

**Type: Extensible**

**Version: 20061024**

<b>Coding Scheme Designator (0008,0102)</b>	<b>Code Value (0008,0100)</b>	<b>Code Meaning (0008,0104)</b>
LN	11885-1	Gestational Age by LMP
LN	11884-4	Average Ultrasound Age
LN	33072-0	AC, ASUM 2000
LN	11889-3	AC, Campbell 1975
LN	11892-7	AC, Hadlock 1984
LN	33073-8	AC, Hansmann1985
LN	33537-2	AC, Jeanty 1982
LN	11893-5	AC, Jeanty 1984
LN	33074-6	AC, Lessoway 1998
LN	33075-3	AC, Mertz 1988
LN	33076-1	AC, Shinozuka 1996
LN	33077-9	A-P Abdominal Diameter, Lessoway 1998
LN	33078-7	AxT, Shinozuka 1996
LN	33079-5	BPD, ASUM 1989
LN	11900-8	BPD, Doubilet 1993
LN	11902-4	BPD, Hadlock 1984
LN	11903-2	BPD, Hansmann 1985
LN	33538-0	BPD, Hansmann 1986
LN	33539-8	BPD, Jeanty 1982

- Standard -



LN	11905-7	BPD, Jeanty 1984
LN	11906-5	BPD, Kurtz 1980
LN	33080-3	BPD, Lessoway 1998
LN	33081-1	BPD, Mertz 1988
LN	33082-9	BPD, Osaka 1989
LN	33083-7	BPD, Rempen 1991
LN	11907-3	BPD, Sabbagha 1978
LN	33084-5	BPD, Shinozuka 1996
LN	33085-2	BPD, Tokyo 1986
LN	11901-6	BPDa, Hadlock 1982
LN	33086-0	BPD-oi, Chitty 1997
LN	33087-8	BPD-oo, Chitty 1997
LN	33088-6	Clavical length, Yarkoni 1985
LN	33089-4	CRL, ASUM 1991
LN	33090-2	CRL, ASUM 2000
LN	33091-0	CRL, Daya 1993
LN	11910-7	CRL, Hadlock 1992
LN	11911-5	CRL, Hansmann 1985
LN	33540-6	CRL, Hansmann 1986
LN	33092-8	CRL, Jeanty 1982
LN	11917-2	CRL, Jeanty 1984
LN	11913-1	CRL, Nelson 1981
LN	33093-6	CRL, Osaka 1989
LN	33094-4	CRL, Rempen 1991
LN	11914-9	CRL, Robinson 1975
LN	33095-1	CRL, Shinozuka 1996
LN	33096-9	CRL, Tokyo 1986
LN	33097-7	Fibula, Jeanty 1983
LN	11918-0	Fibula, Merz 1987
LN	33098-5	FL, Chitty 1997
LN	11920-6	FL, Hadlock 1984
LN	11921-4	FL, Hansmann 1985
LN	33541-4	FL, Hansmann 1986
LN	11922-2	FL, Hohler 1982
LN	33099-3	FL, Jeanty 1982
LN	11923-0	FL, Jeanty 1984
LN	33100-9	FL, Lessoway 1998
LN	11924-8	FL, Merz 1987
LN	33542-2	FL, Merz 1988
LN	33101-7	FL, Osaka 1989
LN	33102-5	FL, Shinozuka 1996
LN	33103-3	FL, Tokyo 1986
LN	11926-3	Foot Length, Mercer 1987
LN	33104-1	GS, Daya 1991

LN	33105-8	GS, Hansmann 1979
LN	33106-6	GS, Hansmann 1982
LN	11928-9	GS, Hellman 1969
LN	33107-4	GS, Nyberg 1992
LN	11929-7	GS, Rempen 1991
LN	33108-2	GS, Tokyo 1986
LN	33109-0	HC, ASUM 2000
LN	33110-8	HC measured, Chitty 1997
LN	33111-6	HC derived, Chitty 1997
LN	11932-1	HC, Hadlock 1984
LN	33112-4	HC, Hansmann 1985
LN	33543-0	HC, Hansmann 1986
LN	33113-2	HC, Jeanty 1982
LN	11934-7	HC, Jeanty 1984
LN	33114-0	HC, Lessoway 1998
LN	33115-7	HC Merz, 1988
LN	33116-5	Humerus Length, ASUM 2000
LN	11936-2	Humerus, Jeanty 1984
LN	11937-0	Humerus, Merz 1987
LN	33117-3	Humerus Length, Osaka 1989
LN	33118-1	Length of Vertebra, Tokyo 1986
LN	33119-9	OFD, ASUM 2000
LN	33544-8	OFD, Hansmann 1985
LN	33120-7	OFD, Hansmann 1986
LN	33121-5	OFD, Lessoway 1998
LN	33122-3	IOD, Mayden 1982
LN	33123-1	IOD, Trout 1994
LN	33545-5	BD, Jeanty 1982
LN	33124-9	OOD, Mayden, 1982
LN	33125-6	OOD, Trout 1994
LN	33126-4	Radius, Jeanty 1983
LN	11939-6	Radius, Merz 1987
LN	33127-2	Spine Length, Tokyo, 1989
LN	11941-2	Tibia, Jeanty 1984
LN	33128-0	TAD, Eriksen 1985
LN	33129-8	TAD Hansmann, 1979
LN	33130-6	TAD, Tokyo 1986
LN	33131-4	ThC, Chitkara 1987
LN	33132-2	TCD, Chitty 1994
LN	33133-0	TCD, Goldstein 1987
LN	33134-8	TCD, Hill 1990
LN	33135-5	TCD, Nimrod 1986
LN	33136-3	Transverse Thoracic Diameter, Hansmann 1985

LN	33137-1	Transverse Thoracic Diameter, Lessoway 1998
LN	33138-9	Fetal Trunk Cross-Sectional Area, Osaka 1989
LN	11944-6	Ulna, Jeanty 1984
LN	11945-3	Ulna, Merz 1987

**CID 12014 OB Fetal Body Weight Equations and Tables**

These terms define a functional relationship to estimated fetal body mass from a biometric measurement.

**Context ID 12014**

**OB Fetal Body Weight Equations and Tables**

Type: Extensible

Version: 20030130

Coding Scheme Designator (0008,0102)	Code Value (0008,0100)	Code Meaning (0008,0104)
LN	11756-4	EFW by AC, Campbell 1975
LN	11738-2	EFW by AC, BPD, Hadlock 1984
LN	11734-1	EFW by AC, BPD, FL, Hadlock 1984
LN	11735-8	EFW by AC, BPD, FL, Hadlock 1985
LN	11732-5	EFW by AC, BPD, FL, HC, Hadlock 1985
LN	11750-7	EFW by AC, FL, Hadlock 1984
LN	11751-5	EFW by AC, FL, Hadlock 1985
LN	11746-5	EFW by AC, FL, HC, Hadlock 1985
LN	11754-9	EFW by AC, HC Hadlock 1984
LN	33139-7	EFW by BPD, TTD, Hansmann 1986
LN	11739-0	EFW by AC and BPD, Shepard 1982
LN	33140-5	EFW by BPD, FTA, FL, Osaka 1990
LN	33141-3	EFW1 by Shinozuka 1996
LN	33142-1	EFW2 by Shinozuka 1996
LN	33143-9	EFW3 by Shinozuka 1996
LN	33144-7	EFW by BPD, APAD, TAD, FL, Tokyo 1987

**CID 12015 Fetal Growth Equations and Tables**

These terms specify biometric growth parameter of a population distribution as a function of gestational age. The term may also specify the population's distribution, and so enable calculating a percentile rank or Z-score relative to the distribution.

**Context ID 12015**

**Fetal Growth Equations and Tables**

Type: Extensible

Version: 20030130

Coding Scheme Designator (0008,0102)	Code Value (0008,0100)	Code Meaning (0008,0104)
LN	33145-4	AC by GA, ASUM 2000
LN	33146-2	AC by GA, Hadlock 1984

<b>Coding Scheme Designator (0008,0102)</b>	<b>Code Value (0008,0100)</b>	<b>Code Meaning (0008,0104)</b>
LN	33147-0	AC (measured) by GA, Chitty 1994
LN	33546-3	AC (derived) by GA, Chitty 1994
LN	33148-8	AC by GA, Merz 1988
LN	33149-6	AC by GA, Shinozuka 1996
LN	33150-4	AxT by GA, Shinozuka 1996
LN	33151-2	BPD by GA, ASUM 2000
LN	33198-3	BPD by GA, Hadlock 1984
LN	33556-2	BPD outer-inner by GA, Chitty 1994
LN	33152-0	BPD outer-outer by GA, Chitty 1994
LN	33153-8	BPD by GA, Jeanty 1982
LN	33154-6	BPD by GA, Merz 1988
LN	33155-3	BPD by GA, Rempen 1991
LN	33156-1	BPD by GA, Shinozuka 1996
LN	33157-9	Cephalic Index by GA, Chitty 1994
LN	33158-7	Cephalic Index by GA, Hadlock 1981
LN	33159-5	CRL by GA ASUM 2000
LN	33160-3	CRL by GA, Rempen1991
LN	33161-1	CRL by GA, Shinozuka 1996
LN	33162-9	EFW by GA, Hadlock 1991
LN	33163-7	EFW by GA, Hansmann 1986
LN	33164-5	Fibula by GA, Jeanty 1983
LN	33165-2	FL by GA, ASUM 2000
LN	33166-0	FL by GA, Hadlock 1984
LN	33167-8	FL by GA, Chitty 1994
LN	33168-6	FL by GA, Jeanty 1982
LN	33169-4	FL by GA, Merz 1988
LN	33170-2	FL by GA, Shinozuka 1996
LN	33171-0	GS by GA, Rempen 1991
LN	33172-8	HC by GA, ASUM 2000
LN	33173-6	HC by GA, Hadlock 1984
LN	33174-4	HC derived by GA, Chitty 1994
LN	33175-1	HC by GA, Jeanty 1982
LN	33176-9	HC by GA, Merz 1988
LN	33177-7	Humerus Length by GA, ASUM 2000
LN	33178-5	OFD by GA, ASUM 2000
LN	33179-3	OFD by GA, Chitty 1994
LN	33180-1	Radius by GA, Jeanty 1983
LN	33181-9	TCD by GA Goldstein 1987
LN	33182-7	HC/AC by GA, Campbell 1977

**CID 12016 Estimated Fetal Weight Percentile Equations and Tables**

These terms specify the population distribution for use in Z-score and percentile rank.

**Context ID 12016**

**Estimated Fetal Weight Percentile Equations and Tables**

**Type: Extensible**

**Version: 20030130**

<b>Coding Scheme Designator (0008,0102)</b>	<b>Code Value (0008,0100)</b>	<b>Code Meaning (0008,0104)</b>
LN	33183-5	FWP by GA, Hadlock 1991
LN	33184-3	FWP by GA, Williams, 1982
LN	33185-0	FWP by GA, Alexander, 1996
LN	33186-8	Male Singleton BWP by GA, Arbuckle 1993
LN	33187-6	Female Singleton BWP by GA, Arbuckle 1993
LN	33199-1	Male Twins BWP by GA, Arbuckle 1993
LN	33188-4	Female Twins BWP by GA, Arbuckle 1993
LN	33189-2	FWP by GA, Brenner 1976
LN	33190-0	FWP by MA, Hadlock 1985

**CID 12017 Growth Distribution Rank**

**Context ID 12017**

**Growth Distribution Rank**

**Type: Extensible**

**Version: 20030130**

<b>Code Scheme</b>	<b>Code Value</b>	<b>Code Meaning</b>
DCM	125012	Growth Percentile Rank
DCM	125013	Growth Z-score

**CID 12018 OB-GYN Summary**

**Context ID 12018**

**OB-GYN SUMMARY**

**Type: Extensible**

**Version: 20030130**

<b>Coding Scheme Designator (0008,0102)</b>	<b>Code Value (0008,0100)</b>	<b>Code Meaning (0008,0104)</b>
LN	11878-6	Number of Fetuses
LN	11886-9	Gestational Age by ovulation date

**CID 12019 OB-GYN Fetus Summary**

**Context ID 12019  
OB-GYN FETUS SUMMARY**

**Type: Extensible Version: 20030130**

<b>Coding Scheme Designator (0008,0102)</b>	<b>Code Value (0008,0100)</b>	<b>Code Meaning (0008,0104)</b>
LN	18185-9	Gestational Age
LN	11888-5	Composite Ultrasound Age
LN	11885-1	Gestational Age by LMP
LN	11727-5	Estimated Weight
LN	11767-1	EFW percentile rank
LN	11948-7	Fetal Heart Rate

**CID 12101 Vascular Summary**

**Context ID 12101  
Vascular Summary**

**Type: Extensible Version: 20030327**

<b>Coding Scheme Designator (0008,0102)</b>	<b>Code Value (0008,0100)</b>	<b>Code Meaning (0008,0104)</b>
DCM	121106	Comment

**CID 12102 Temporal Periods Relating to Procedure or Therapy**

**Context ID 12102  
Temporal Periods Relating to Procedure or Therapy**

**Type: Extensible Version: 20050110**

<b>Coding Scheme Designator (0008,0102)</b>	<b>Code Value (0008,0100)</b>	<b>Code Meaning (0008,0104)</b>
SRT	R-422A4	After Procedure
SRT	R-40FBA	During Procedure
SRT	R-40FB9	Before Procedure

**CID 12103 Vascular Ultrasound Anatomic Location**

**Context ID 12103**

**Vascular Ultrasound Anatomic Location**

**Type: Extensible**

**Version: 20030327**

<b>Coding Scheme Designator (0008,0102)</b>	<b>Code Value (0008,0100)</b>	<b>Code Meaning (0008,0104)</b>
		INCLUDE CID 12104 Extracranial Arteries
		INCLUDE CID 12105 Intracranial Cerebral Vessels
		INCLUDE CID 12106 Intracranial Cerebral Vessels (unilateral)
		INCLUDE CID 12107 Upper Extremity Arteries
		INCLUDE CID 12108 Upper Extremity Veins
		INCLUDE CID 12109 Lower Extremity Arteries
		INCLUDE CID 12110 Lower Extremity Veins
		INCLUDE CID 12111 Abdominal Arteries (lateral)
		INCLUDE CID 12112 Abdominal Arteries (unilateral)
		INCLUDE CID 12113 Abdominal Veins (lateral)
		INCLUDE CID 12114 Abdominal Veins (unilateral)
		INCLUDE CID 12115 Renal Vessels

**CID 12104 Extracranial Arteries**

This context group specifies the anatomic location for vascular observations

**Context ID 12104**

**Extracranial Arteries**

**Type: Extensible**

**Version: 20030327**

<b>Coding Scheme Designator (0008,0102)</b>	<b>Code Value (0008,0100)</b>	<b>Code Meaning (0008,0104)</b>
SRT	T-45160	Carotid Bifurcation
SRT	T-45170	Carotid Bulb
SRT	T-45100	Common Carotid Artery
SRT	T-45200	External Carotid Artery
SRT	T-45300	Internal Carotid Artery
SRT	T-46100	Subclavian Artery
SRT	T-45700	Vertebral Artery

**CID 12105 Intracranial Cerebral Vessels**

**Context ID 12105**

**Intracranial Cerebral Vessels**

**Type: Extensible**

**Version: 20050110**

<b>Coding Scheme Designator (0008,0102)</b>	<b>Code Value (0008,0100)</b>	<b>Code Meaning (0008,0104)</b>
SRT	T-45540	Anterior Cerebral Artery
SRT	T-45530	Anterior Communicating Artery
SRT	G-0368	Anterior-Middle Cerebral Artery Bifurcation
SRT	G-0369	Anterior-Posterior Cerebral Artery Bifurcation
SRT	T-45308	Carotid Siphon
SRT	T-45430	Central Retinal Artery
SRT	T-48286	Central Retinal Vein
SRT	T-45300	Internal Carotid Artery
SRT	R-102BB	Internal Carotid Artery C5 segment
SRT	R-102BC	Internal Carotid Artery C6 segment
SRT	R-102BD	Terminal internal carotid artery
SRT	T-45600	Middle Cerebral Artery
SRT	R-1024F	Middle Cerebral Artery M1 Segment
SRT	R-10251	Middle Cerebral Artery M2 Segment
SRT	T-45400	Ophthalmic Artery
SRT	T-45900	Posterior Cerebral Artery
SRT	R-10253	Posterior Cerebral Artery P1 Segment
SRT	R-10255	Posterior Cerebral Artery P2 Segment
SRT	T-45320	Posterior Communicating Artery

**CID 12106 Intracranial Cerebral Vessels (unilateral)**

**Context ID 12106**

**Intracranial Cerebral Vessels (unilateral)**

**Type: Extensible**

**Version: 20030327**

<b>Coding Scheme Designator (0008,0102)</b>	<b>Code Value (0008,0100)</b>	<b>Code Meaning (0008,0104)</b>
SRT	T-45800	Basilar Artery



**CID 12107 Upper Extremity Arteries**

**Context ID 12107**

**Upper Extremity Arteries**

**Type: Extensible**

**Version: 20050110**

<b>Coding Scheme Designator (0008,0102)</b>	<b>Code Value (0008,0100)</b>	<b>Code Meaning (0008,0104)</b>
SRT	T-47100	Axillary Artery
SRT	T-47160	Brachial Artery
SRT	T-47340	Deep Palmar Arch of Radial Artery
SRT	T-46010	Innominate Artery
SRT	T-47300	Radial Artery
SRT	T-46100	Subclavian Artery
SRT	T-47240	Superficial Palmar Arch
SRT	T-47200	Ulnar Artery
SRT	T-47260	Digital artery of hand

**CID 12108 Upper Extremity Veins**

**Context ID 12108  
Upper Extremity Veins**

**Type: Extensible Version: 20030327**

<b>Coding Scheme Designator (0008,0102)</b>	<b>Code Value (0008,0100)</b>	<b>Code Meaning (0008,0104)</b>
SRT	T-49110	Axillary vein
SRT	T-48052	Basilic vein
SRT	T-49350	Brachial vein
SRT	T-49240	Cephalic vein
SRT	T-48620	Innominate vein
SRT	T-48170	Internal Jugular vein
SRT	T-49250	Median Cubital vein
SRT	T-49340	Radial vein
SRT	T-48330	Subclavian vein
SRT	T-49330	Ulnar vein
SRT	T-48610	Superior Vena Cava
SRT	T-49218	Deep Palmar Venous Arch
SRT	T-49217	Superficial Palmar Venous Arch

**CID 12109 Lower Extremity Arteries**

**Context ID 12109  
Lower Extremity Arteries**

**Type: Extensible Version: 20050110**

<b>Coding Scheme Designator (0008,0102)</b>	<b>Code Value (0008,0100)</b>	<b>Code Meaning (0008,0104)</b>
SRT	T-46710	Common Iliac Artery
SRT	R-10258	Common Iliac Artery Bifurcation
SRT	T-47700	Anterior Tibial Artery
SRT	T-47400	Common Femoral Artery
SRT	T-47741	Dorsalis Pedis Artery
SRT	T-46910	External Iliac Artery
SRT	T-46740	Internal Iliac Artery
SRT	T-47630	Peroneal Artery
SRT	T-47690	Plantar Arterial Arch
SRT	T-47500	Popliteal Artery
SRT	T-47600	Posterior Tibial Artery
SRT	T-47440	Profunda Femoris Artery
SRT	T-47403	Superficial Femoral Artery

**CID 12110 Lower Extremity Veins**

**Context ID 12110**

**Lower Extremity Veins**

**Type: Extensible**

**Version: 20050110**

<b>Coding Scheme Designator (0008,0102)</b>	<b>Code Value (0008,0100)</b>	<b>Code Meaning (0008,0104)</b>
SRT	T-49630	Anterior Tibial Vein
SRT	T-49423	Lateral calf perforator
SRT	G-035B	Common Femoral Vein
SRT	T-48920	Common Iliac Vein
SRT	T-48930	External Iliac Vein
SRT	T-4942D	Gastrocnemius vein
SRT	G-036F	Giacomini vein
SRT	T-49530	Great Saphenous Vein
SRT	R-10259	Great Saphenous Vein of Thigh
SRT	R-1025A	Great Saphenous Vein of Calf
SRT	T-49550	Lesser Saphenous Vein
SRT	T-49650	Peroneal Vein
SRT	T-49640	Popliteal Vein
SRT	G-036E	Posterior arch vein
SRT	T-49620	Posterior Tibial Vein
SRT	T-49660	Profunda Femoris Vein
SRT	T-D930A	Saphenofemoral Junction
SRT	G-036B	Soleal vein
SRT	G-035A	Superficial Femoral Vein
SRT	T-4942C	Thigh perforator
SRT	T-48940	Internal iliac vein
SRT	T-4941A	Saphenopopliteal junction
SRT	T-4942A	Hunterian perforating vein
SRT	T-49426	Cockett's perforating vein
SRT	T-49424	Boyd's perforating vein

**CID 12111 Abdominal Arteries (lateral)**

**Context ID 12111**

**Abdominal Arteries (lateral)**

**Type: Extensible**

**Version: 20050110**

<b>Coding Scheme Designator (0008,0102)</b>	<b>Code Value (0008,0100)</b>	<b>Code Meaning (0008,0104)</b>
---	-------------------------------	---------------------------------

SRT	T-46640	Accessory Renal Artery
SRT	T-46410	Gastric Artery
SRT	T-46980	Ovarian Artery
SRT	T-46970	Testicular Artery
SRT	T-F1810	Umbilical Artery
SRT	T-46820	Uterine Artery

**CID 12112 Abdominal Arteries (unilateral)**

**Context ID 12112**

**Abdominal Arteries (unilateral)**

**Type: Extensible Version: 20050110**

<b>Coding Scheme Designator (0008,0102)</b>	<b>Code Value (0008,0100)</b>	<b>Code Meaning (0008,0104)</b>
SRT	T-42000	Aorta
SRT	T-42520	Infra-renal Aorta
SRT	T-42510	Supra-renal Aorta
SRT	T-46400	Celiac Axis
SRT	T-46421	Common Hepatic Artery
SRT	T-46710	Common Iliac Artery
SRT	T-46440	Gastroduodenal Artery
SRT	T-46520	Inferior Mesenteric Artery
SRT	T-46960	Lumbar Artery
SRT	T-46422	Proper Hepatic Artery
SRT	T-46423	Right Branch of Hepatic Artery
SRT	T-46427	Left Branch of Hepatic Artery
SRT	T-46460	Splenic Artery
SRT	T-46510	Superior Mesenteric Artery

**CID 12113 Abdominal Veins (lateral)**

**Context ID 12113**

**Abdominal Veins (lateral)**

**Type: Extensible Version: 20030327**

<b>Coding Scheme Designator (0008,0102)</b>	<b>Code Value (0008,0100)</b>	<b>Code Meaning (0008,0104)</b>
SRT	T-48920	Common iliac vein
SRT	T-48820	Gastric vein
SRT	G-0370	Ileal vein

SRT	T-48780	Ovarian vein
SRT	T-48770	Testicular Vein
SRT	G-035E	First Lumbar Artery
SRT	G-035F	Second Lumbar Artery
SRT	G-0360	Third Lumbar Artery
SRT	G-0361	Fourth Lumbar Artery
SRT	G-0362	Fifth Lumbar Artery
SRT	G-0363	Sixth Lumbar Artery

**CID 12114 Abdominal Veins (unilateral)**

**Context ID 12114**

**Abdominal Veins (unilateral)**

**Type: Extensible**

**Version: 20030327**

<b>Coding Scheme Designator (0008,0102)</b>	<b>Code Value (0008,0100)</b>	<b>Code Meaning (0008,0104)</b>
SRT	T-48720	Hepatic Vein
SRT	G-036D	Inferior Right Hepatic Vein
SRT	T-48727	Left Hepatic Vein
SRT	T-48726	Middle Hepatic Vein
SRT	T-48725	Right Hepatic Vein
SRT	T-48810	Portal Vein
SRT	T-4881F	Left Main Branch of Portal Vein
SRT	T-4882A	Right Main Branch of Portal Vein
SRT	T-48910	Inferior Mesenteric Vein
SRT	T-48710	Inferior Vena Cava
SRT	T-48890	Splenic Vein
SRT	T-48840	Superior Mesenteric Vein
SRT	G-036C	Transjugular Intrahepatic Portosystemic Shunt
SRT	T-48817	Umbilical Vein

**CID 12115 Renal Vessels**

**Context ID 12115**

**Renal Vessels**

**Type: Extensible**

**Version: 20030327**

<b>Coding Scheme Designator (0008,0102)</b>	<b>Code Value (0008,0100)</b>	<b>Code Meaning (0008,0104)</b>

SRT	T-46600	Renal Artery
SRT	G-035C	Hilar Artery
SRT	T-46659	Segmental Artery
SRT	T-4667C	Lobar Artery
SRT	T-4668A	Arcuate Artery of the Kidney
SRT	T-4667D	Interlobar Artery of Kidney
SRT	T-46640	Accessory Renal Artery
SRT	T-46668	Perforating Artery of Kidney
SRT	T-48740	Renal Vein

**CID 12116 Vessel Segment Modifiers**

This context group is the set of modifiers that specify the position along a vessel segment.

**Context ID 12116**

**Vessel Segment Modifiers**

Type: Extensible Version: 20050110

Coding Scheme Designator (0008,0102)	Code Value (0008,0100)	Code Meaning (0008,0104)
SRT	G-A119	Distal
SRT	G-A188	Mid-longitudinal
SRT	G-036A	Origin of vessel
SRT	G-A118	Proximal
SRT	R-1025B	Dilated portion of segment

**CID 12117 Vessel Branch Modifiers**

This context group is the set of modifiers to specify a particular vessel segment or branch.

**Context ID 12117**

**Vessel Branch Modifiers**

Type: Extensible Version: 20030327

Coding Scheme Designator (0008,0102)	Code Value (0008,0100)	Code Meaning (0008,0104)
SRT	G-035D	Collateral branch of vessel
SRT	G-A115	Inferior
SRT	G-A104	Lateral
SRT	G-A101	Left
SRT	G-A332	Main
SRT	G-A109	Medial
SRT	G-A100	Right

<b>Coding Scheme Designator (0008,0102)</b>	<b>Code Value (0008,0100)</b>	<b>Code Meaning (0008,0104)</b>
SRT	G-A116	Superior

**CID 12119 Vascular Ultrasound Property**

**Context ID 12119**

**Vascular Ultrasound Property**

**Type: Extensible**

**Version: 20030327**

<b>Coding Scheme Designator (0008,0102)</b>	<b>Code Value (0008,0100)</b>	<b>Code Meaning (0008,0104)</b>
INCLUDE CID 12120 Blood Velocity Measurements		
INCLUDE CID 12121 Vascular Indices and Ratios		
INCLUDE CID 12122 Other Vascular Properties		

**CID 12120 Blood Velocity Measurements**

**Context ID 12120**

**Blood Velocity Measurements**

**Type: Extensible**

**Version: 20030327**

<b>Coding Scheme Designator (0008,0102)</b>	<b>Code Value (0008,0100)</b>	<b>Code Meaning (0008,0104)</b>
LN	11653-3	End Diastolic Velocity
LN	11665-7	Minimum Diastolic Velocity
LN	11726-7	Peak Systolic Velocity
LN	20352-1	Time averaged mean velocity
LN	11692-1	Time averaged peak velocity

**CID 12121 Vascular Indices and Ratios**

**Context ID 12121**

**Vascular Indices and Ratios**

**Type: Extensible**

**Version: 20050110**

<b>Coding Scheme Designator (0008,0102)</b>	<b>Code Value (0008,0100)</b>	<b>Code Meaning (0008,0104)</b>
LN	20167-3	Acceleration Index
SRT	R-101BA	Lumen Area Stenosis
SRT	R-101BB	Lumen Diameter Stenosis
LN	12008-9	Pulsatility Index

<b>Coding Scheme Designator (0008,0102)</b>	<b>Code Value (0008,0100)</b>	<b>Code Meaning (0008,0104)</b>
LN	12023-8	Resistivity Index
LN	12144-2	Systolic to Diastolic Velocity Ratio
LN	33867-3	Velocity ratio

Note: This Context Group formerly included SNOMED codes G-0371 and G-0372, which have been replaced by R-101BA and R-101BB, respectively. See Annex J.

**CID 12122 Other Vascular Properties**

**Context ID 12122**

**Other Vascular Properties**

**Type: Extensible**

**Version: 20050110**

<b>Coding Scheme Designator (0008,0102)</b>	<b>Code Value (0008,0100)</b>	<b>Code Meaning (0008,0104)</b>
LN	20168-1	Acceleration Time
LN	20217-6	Deceleration Time
SRT	G-0364	Vessel lumen diameter
SRT	R-1025C	Vessel Intimal Diameter
SRT	R-1025D	Vessel Intimal Cross-Sectional Area
SRT	G-0365	Vessel outside diameter
SRT	G-0366	Vessel lumen cross-sectional area
LN	33878-0	Volume flow
SRT	R-1025E	Vessel depth from surface
LN	20247-3	Peak Gradient
LN	20256-4	Mean Gradient
SRT	R-1025F	Length of Segment

**CID 12123 Carotid Ratios**

**Context ID 12123**

**Carotid Ratios**

**Type: Extensible**

**Version: 20030327**

<b>Coding Scheme Designator (0008,0102)</b>	<b>Code Value (0008,0100)</b>	<b>Code Meaning (0008,0104)</b>
LN	33868-1	ICA/CCA velocity ratio



**CID 12124 Renal Ratios**

**Context ID 12124**

**Renal Ratios**

**Type: Extensible**

**Version: 20030327**

<b>Coding Scheme Designator (0008,0102)</b>	<b>Code Value (0008,0100)</b>	<b>Code Meaning (0008,0104)</b>
LN	33869-9	Renal Artery/Aorta velocity ratio

**CID 12140 Pelvic Vasculature Anatomical Location**

**Context ID 12140**

**Pelvic Vasculature Anatomical Location**

**Type: Extensible**

**Version: 20040322**

<b>Coding Scheme Designator (0008,0102)</b>	<b>Code Value (0008,0100)</b>	<b>Code Meaning (0008,0104)</b>
SRT	T-F1810	Umbilical Artery
SRT	T-F1820	Umbilical Vein
SRT	T-46980	Ovarian Artery
SRT	T-48780	Ovarian Vein
SRT	T-46820	Uterine Artery
SRT	T-49010	Uterine Vein
SRT	T-F1412	Vitelline Artery of Placenta
SRT	T-F1413	Vitelline Vein of Placenta
SRT	T-46710	Common Iliac Artery

**CID 12141 Fetal Vasculature Anatomical Location**

**Context ID 12141**

**Fetal Vasculature Anatomical Location**

**Type: Extensible**

**Version: 20040322**

<b>Coding Scheme Designator (0008,0102)</b>	<b>Code Value (0008,0100)</b>	<b>Code Meaning (0008,0104)</b>
SRT	T-42000	Aorta
SRT	T-D0765	Descending Aorta
SRT	T-45600	Middle Cerebral Artery
SRT	T-48581	Pulmonary Vein
SRT	T-44000	Pulmonary Artery

**CID 12200 Echocardiography Left Ventricle**

**Context ID 12200**  
**Echocardiography Left Ventricle**  
**Type: Extensible Version: 20030918**

Coding Scheme Designator (0008,0102)	Code Value (0008,0100)	Code Meaning (0008,0104)
INCLUDE CID 12220 Echocardiography Common Measurements		
INCLUDE CID 12201 Left Ventricle Linear		
INCLUDE CID 12240 Left Ventricle Area		
INCLUDE CID 12202 Left Ventricle Volume		
INCLUDE CID 12222 Orifice Flow Properties		
INCLUDE CID 12203 Left Ventricle Other		
INCLUDE CID 12239 Cardiac Output Properties		

**CID 12201 Left Ventricle Linear**

**Context ID 12201**  
**Left Ventricle Linear**  
**Type: Extensible Version: 20030918**

Coding Scheme Designator (0008,0102)	Code Value (0008,0100)	Code Meaning (0008,0104)
LN	29436-3	Left Ventricle Internal End Diastolic Dimension
LN	29438-9	Left Ventricle Internal Systolic Dimension
LN	18051-3	Left Ventricular Fractional Shortening
LN	18154-5	Interventricular Septum Diastolic Thickness
LN	18155-2	Interventricular Septum to Posterior Wall Thickness Ratio
LN	18054-7	Interventricular Septum % Thickening
LN	18158-6	Interventricular Septum Systolic Thickness
LN	18053-9	Left Ventricle Posterior Wall % Thickening
LN	18077-8	Left Ventricle diastolic major axis
LN	18076-0	Left Ventricle systolic major axis
LN	18156-0	Left Ventricle Posterior Wall Systolic Thickness
LN	18152-9	Left Ventricle Posterior Wall Diastolic Thickness
SRT	G-0377	Left Ventricle Semi-major Axis Diastolic Dimension
SRT	G-0378	Left Ventricle Truncated Semi-major Axis Diastolic Dimension

**CID 12202 Left Ventricle Volume**

**Context ID 12202  
Left Ventricle Volume**

**Type: Extensible Version: 20030918**

<b>Coding Scheme Designator (0008,0102)</b>	<b>Code Value (0008,0100)</b>	<b>Code Meaning (0008,0104)</b>
LN	18026-5	Left Ventricular End Diastolic Volume
LN	18148-7	Left Ventricular End Systolic Volume
LN	18043-0	Left Ventricular Ejection Fraction

**CID 12203 Left Ventricle Other**

**Context ID 12203  
Left Ventricle Other**

**Type: Extensible Version: 20030918**

<b>Coding Scheme Designator (0008,0102)</b>	<b>Code Value (0008,0100)</b>	<b>Code Meaning (0008,0104)</b>
LN	18087-7	Left Ventricle Mass
LN	18071-1	Left Ventricular Isovolumic Relaxation Time
SRT	G-037E	Left Ventricular Isovolumic Contraction Time
SRT	G-037A	Left Ventricular Peak Early Diastolic Tissue Velocity
SRT	G-037B	Ratio of MV Peak Velocity to LV Peak Tissue Velocity E-Wave
SRT	G-037C	LV Peak Diastolic Tissue Velocity During Atrial Systole
SRT	G-037D	Left Ventricular Peak Systolic Tissue Velocity
SRT	G-037F	Left Ventricular Index of Myocardial Performance

**CID 12204 Echocardiography Right Ventricle**

**Context ID 12204  
Echocardiography Right Ventricle**

**Type: Extensible Version: 20030918**

<b>Coding Scheme Designator (0008,0102)</b>	<b>Code Value (0008,0100)</b>	<b>Code Meaning (0008,0104)</b>
INCLUDE CID 12220 Echocardiography Common Measurements		
INCLUDE CID 12222 Orifice Flow Properties		
INCLUDE CID 12239 Cardiac Output Properties		
LN	20304-2	Right Ventricular Internal Diastolic Dimension
LN	20305-9	Right Ventricular Internal Systolic Dimension
SRT	G-0381	Right Ventricular Index of Myocardial Performance
SRT	G-0380	Right Ventricular Peak Systolic Pressure

<b>Coding Scheme Designator (0008,0102)</b>	<b>Code Value (0008,0100)</b>	<b>Code Meaning (0008,0104)</b>
LN	18153-7	Right Ventricular Anterior Wall Diastolic Thickness
LN	18157-8	Right Ventricular Anterior Wall Systolic Thickness

**CID 12205 Echocardiography Left Atrium**

**Context ID 12205  
Echocardiography Left Atrium**

**Type: Extensible Version: 20030918**

<b>Coding Scheme Designator (0008,0102)</b>	<b>Code Value (0008,0100)</b>	<b>Code Meaning (0008,0104)</b>
INCLUDE CID 12220 Echocardiography Common Measurements		
LN	29469-4	Left Atrium Antero-posterior Systolic Dimension
LN	17985-3	Left Atrium to Aortic Root Ratio
LN	29486-8	Left Atrial Appendage Peak Velocity
LN	17977-0	Left Atrium Systolic Area
SRT	G-0383	Left Atrium Systolic Volume

**CID 12206 Echocardiography Right Atrium**

**Context ID 12206  
Echocardiography Right Atrium**

**Type: Extensible Version: 20030918**

<b>Coding Scheme Designator (0008,0102)</b>	<b>Code Value (0008,0100)</b>	<b>Code Meaning (0008,0104)</b>
INCLUDE CID 12220 Echocardiography Common Measurements		
LN	18070-3	Right Atrium Systolic Pressure
LN	17988-7	Right Atrium Systolic Area

**CID 12207 Echocardiography Mitral Valve**

**Context ID 12207  
Echocardiography Mitral Valve**

**Type: Extensible Version: 20030918**

<b>Coding Scheme Designator (0008,0102)</b>	<b>Code Value (0008,0100)</b>	<b>Code Meaning (0008,0104)</b>
INCLUDE CID 12220 Echocardiography Common Measurements		
INCLUDE CID 12222 Orifice Flow Properties		
INCLUDE CID 12239 Cardiac Output Properties		
LN	17978-8	Mitral Valve A-Wave Peak Velocity
LN	18037-2	Mitral Valve E-Wave Peak Velocity
LN	18038-0	Mitral Valve E to A Ratio
SRT	G-0386	Mitral Valve AT/DT Ratio
SRT	G-0384	Mitral Valve E-Wave Deceleration Time

<b>Coding Scheme Designator (0008,0102)</b>	<b>Code Value (0008,0100)</b>	<b>Code Meaning (0008,0104)</b>
LN	18040-6	Mitral Valve E-F Slope by M-Mode
LN	18036-4	Mitral Valve EPSS, E wave
SRT	G-0385	Mitral Valve A-Wave Duration
LN	18057-0	Mitral Valve Diastolic Peak Instantaneous Gradient
SRT	G-0387	Mitral Valve Closure to Opening Time
LN	18035-6	Mitral Regurgitation dP/dt derived from Mitral Reg. velocity

**CID 12208 Echocardiography Tricuspid Valve**

**Context ID 12208**  
**Echocardiography Tricuspid Valve**  
**Type: Extensible Version: 20030918**

<b>Coding Scheme Designator (0008,0102)</b>	<b>Code Value (0008,0100)</b>	<b>Code Meaning (0008,0104)</b>
INCLUDE CID 12220 Echocardiography Common Measurements		
INCLUDE CID 12222 Orifice Flow Properties		
LN	18031-5	Tricuspid Valve E Wave Peak Velocity
LN	18030-7	Tricuspid Valve A Wave Peak Velocity
LN	18039-8	Tricuspid Valve E to A Ratio
LN	20296-0	Time from Q wave to Tricuspid Valve Opens
SRT	G-0389	Tricuspid Valve Closure to Opening Time
LN	18034-9	Tricuspid Regurgitation dP/dt

**CID 12209 Echocardiography Pulmonic Valve**

**Context ID 12209**  
**Echocardiography Pulmonic Valve**  
**Type: Extensible Version: 20030918**

<b>Coding Scheme Designator (0008,0102)</b>	<b>Code Value (0008,0100)</b>	<b>Code Meaning (0008,0104)</b>
INCLUDE CID 12220 Echocardiography Common Measurements		
INCLUDE CID 12222 Orifice Flow Properties		
LN	18096-8	Pulmonic Valve Area by continuity
LN	18042-2	Pulmonic Valve Ejection Time
SRT	G-0388	Ratio of Pulmonic Valve Acceleration Time to Ejection Time
LN	20295-2	Time from Q wave to Pulmonic Valve Closes

**CID 12210 Echocardiography Pulmonary Artery**

**Context ID 12210  
Echocardiography Pulmonary Artery  
Type: Extensible Version: 20030918**

<b>Coding Scheme Designator (0008,0102)</b>	<b>Code Value (0008,0100)</b>	<b>Code Meaning (0008,0104)</b>
INCLUDE CID 12220 Echocardiography Common Measurements		
LN	18020-8	Main Pulmonary Artery Diameter
LN	18021-6	Right Pulmonary Artery Diameter
LN	18019-0	Left Pulmonary Artery Diameter
SRT	G-038A	Main Pulmonary Artery Peak Velocity

**CID 12211 Echocardiography Aortic Valve**

**Context ID 12211  
Echocardiography Aortic Valve  
Type: Extensible Version: 20030918**

<b>Coding Scheme Designator (0008,0102)</b>	<b>Code Value (0008,0100)</b>	<b>Code Meaning (0008,0104)</b>
INCLUDE CID 12220 Echocardiography Common Measurements		
INCLUDE CID 12222 Orifice Flow Properties		
LN	17996-0	Aortic Valve Cusp Separation
LN	18041-4	Aortic Valve Ejection Time
SRT	G-0382	Ratio of Aortic Valve Acceleration Time to Ejection Time

**CID 12212 Echocardiography Aorta**

**Context ID 12212  
Echocardiography Aorta  
Type: Extensible Version: 20030918**

<b>Coding Scheme Designator (0008,0102)</b>	<b>Code Value (0008,0100)</b>	<b>Code Meaning (0008,0104)</b>
INCLUDE CID 12220 Echocardiography Common Measurements		
LN	18015-8	Aortic Root Diameter
LN	18011-7	Aortic Arch Diameter
LN	18012-5	Ascending Aortic Diameter
LN	18014-1	Aortic Isthmus Diameter
LN	18013-3	Descending Aortic Diameter
LN	17995-2	Thoracic Aorta Coarctation Systolic Peak Instantaneous Gradient
LN	29460-3	Thoracic Aorta Coarctation Systolic Peak Velocity

**CID 12214 Echocardiography Pulmonary Veins**

**Context ID 12214**  
**Echocardiography Pulmonary Veins**  
**Type: Extensible Version: 20030918**

<b>Coding Scheme Designator (0008,0102)</b>	<b>Code Value (0008,0100)</b>	<b>Code Meaning (0008,0104)</b>
INCLUDE CID 12220 Echocardiography Common Measurements		
LN	29450-4	Pulmonary Vein Systolic Peak Velocity
LN	29451-2	Pulmonary Vein Diastolic Peak Velocity
LN	29452-0	Pulmonary Vein Systolic to Diastolic Ratio
LN	29453-8	Pulmonary Vein Atrial Contraction Reversal Peak Velocity
SRT	G-038B	Pulmonary Vein A-Wave Duration
SRT	G-038D	Pulmonary Vein D-Wave Velocity Time Integral
SRT	G-038C	Pulmonary Vein S-Wave Velocity Time Integral

**CID 12215 Echocardiography Vena Cavae**

**Context ID 12215**  
**Echocardiography Vena Cavae**  
**Type: Extensible Version: 20030918**

<b>Coding Scheme Designator (0008,0102)</b>	<b>Code Value (0008,0100)</b>	<b>Code Meaning (0008,0104)</b>
INCLUDE CID 12220 Echocardiography Common Measurements		
LN	18006-7	Inferior Vena Cava Diameter
LN	18050-5	Inferior Vena Cava % Collapse

**CID 12216 Echocardiography Hepatic Veins**

**Context ID 12216**  
**Echocardiography Hepatic Veins**  
**Type: Extensible Version: 20030918**

<b>Coding Scheme Designator (0008,0102)</b>	<b>Code Value (0008,0100)</b>	<b>Code Meaning (0008,0104)</b>
INCLUDE CID 12220 Echocardiography Common Measurements		
LN	29471-0	Hepatic Vein Systolic Peak Velocity
LN	29472-8	Hepatic Vein Diastolic Peak Velocity
LN	29473-6	Hepatic Vein Systolic to Diastolic Ratio
LN	29474-4	Hepatic Vein Atrial Contraction Reversal Peak Velocity

**CID 12217 Echocardiography Cardiac Shunt**

**Context ID 12217**  
**Echocardiography Cardiac Shunt**  
**Type: Extensible Version: 20030918**

<b>Coding Scheme Designator (0008,0102)</b>	<b>Code Value (0008,0100)</b>	<b>Code Meaning (0008,0104)</b>
INCLUDE CID 12220 Echocardiography Common Measurements		
LN	29462-9	Pulmonary-to-Systemic Shunt Flow Ratio

**CID 12218 Echocardiography Congenital**

**Context ID 12218**  
**Echocardiography Congenital**  
**Type: Extensible Version: 20030918**

<b>Coding Scheme Designator (0008,0102)</b>	<b>Code Value (0008,0100)</b>	<b>Code Meaning (0008,0104)</b>
INCLUDE CID 12220 Echocardiography Common Measurements		
INCLUDE CID 12222 Orifice Flow Properties		

**CID 12219 Pulmonary Vein Modifiers**

**Context ID 12219**  
**Pulmonary Vein Modifiers**  
**Type: Extensible Version: 20030918**

<b>Coding Scheme Designator (0008,0102)</b>	<b>Code Value (0008,0100)</b>	<b>Code Meaning (0008,0104)</b>
SRT	R-404A0	Right Upper Segment
SRT	R-4049E	Right Lower Segment
SRT	R-40491	Left Upper Segment
SRT	R-4214B	Left Lower Segment

**CID 12220 Echocardiography Common Measurements**

**Context ID 12220**  
**Echocardiography Common Measurements**  
**Type: Extensible Version: 20030918**

<b>Coding Scheme Designator (0008,0102)</b>	<b>Code Value (0008,0100)</b>	<b>Code Meaning (0008,0104)</b>
LN	8867-4	Heart rate



**CID 12221 Flow Direction**

**Context ID 12221  
Flow Direction**

**Type: Extensible Version: 20030918**

<b>Coding Scheme Designator (0008,0102)</b>	<b>Code Value (0008,0100)</b>	<b>Code Meaning (0008,0104)</b>
SRT	R-42047	Antegrade Flow
SRT	R-42E61	Regurgitant Flow

**CID 12222 Orifice Flow Properties**

**Context ID 12222  
Orifice Flow Properties**

**Type: Extensible Version: 20030918**

<b>Coding Scheme Designator (0008,0102)</b>	<b>Code Value (0008,0100)</b>	<b>Code Meaning (0008,0104)</b>
LN	33878-0	Volume Flow
LN	34141-2	Peak Instantaneous Flow Rate
SRT	G-038E	Cardiovascular Orifice Area
SRT	G-038F	Cardiovascular Orifice Diameter
SRT	G-0390	Regurgitant Fraction
LN	11653-3	End Diastolic Velocity
LN	11726-7	Peak Velocity
LN	20352-1	Mean Velocity
LN	20247-3	Peak Gradient
LN	20256-4	Mean Gradient
LN	20354-7	Velocity Time Integral
LN	20280-4	Pressure Half-Time
LN	20168-1	Acceleration Time
LN	20217-6	Deceleration Time
LN	20216-8	Deceleration Slope

**CID 12223 Echocardiography Stroke Volume Origin**

**Context ID 12223  
Echocardiography Stroke Volume Origin**

**Type: Extensible Version: 20030918**

<b>Coding Scheme Designator (0008,0102)</b>	<b>Code Value (0008,0100)</b>	<b>Code Meaning (0008,0104)</b>
SNM3	T-32600	Left Ventricle
SNM3	T-32650	Left Ventricle Outflow Tract
SNM3	T-32550	Right Ventricle Outflow Tract

<b>Coding Scheme Designator (0008,0102)</b>	<b>Code Value (0008,0100)</b>	<b>Code Meaning (0008,0104)</b>
SNM3	T-35300	Mitral Valve
SNM3	T-42000	Aorta

**CID 12224      Ultrasound Image Modes**

**Context ID 12224  
Ultrasound Image Modes**

**Type: Extensible Version: 20060622**

<b>Coding Scheme Designator (0008,0102)</b>	<b>Code Value (0008,0100)</b>	<b>Code Meaning (0008,0104)</b>
SRT	G-03A2	2D mode
SRT	R-409E2	Doppler Color Flow
SRT	G-0394	M mode
SRT	R-409E4	Doppler Pulsed
SRT	R-409E3	Doppler Continuous Wave
DCM	125230	Power Doppler
DCM	125231	3D mode

**CID 12226      Echocardiography Image View**

**Context ID 12226  
Echocardiography Image View**

**Type: Extensible Version: 20030918**

<b>Coding Scheme Designator (0008,0102)</b>	<b>Code Value (0008,0100)</b>	<b>Code Meaning (0008,0104)</b>
SRT	G-A19B	Apical two chamber
SRT	G-A19C	Apical four chamber
SRT	G-0395	Apical long axis
SRT	G-0396	Parasternal long axis
SRT	G-0397	Parasternal short axis
SRT	G-0398	Parasternal short axis at the aortic valve level
SRT	G-0399	Parasternal short axis at the level of the mitral chords
SRT	G-039A	Parasternal short axis at the Mitral Valve level
SRT	G-039B	Parasternal short axis at the Papillary Muscle level
SRT	G-039C	Right Ventricular Inflow Tract View
SRT	G-039D	Right Ventricular Outflow Tract View

<b>Coding Scheme Designator (0008,0102)</b>	<b>Code Value (0008,0100)</b>	<b>Code Meaning (0008,0104)</b>
SRT	G-039E	Subcostal long axis
SRT	G-039F	Subcostal short axis
SRT	G-03A0	Suprasternal long axis
SRT	G-03A1	Suprasternal short axis

**CID 12227 Echocardiography Measurement Method**

**Context ID\_12227  
Echocardiography Measurement Method**

**Type: Extensible Version: 20030918**

<b>Code Scheme</b>	<b>Code Value</b>	<b>Concept Name</b>
INCLUDE CID 12228 Volume Methods		
INCLUDE CID 12229 Area Methods		
INCLUDE CID 12230 Gradient Methods		
INCLUDE CID 12231 Volume Flow Methods		
INCLUDE CID 12232 Myocardium Mass Methods		

**CID 12228 Volume Methods**

**Context ID\_12228  
Volume Methods**

**Type: Extensible Version: 20030918**

<b>Coding Scheme Designator (0008,0102)</b>	<b>Code Value (0008,0100)</b>	<b>Code Meaning (0008,0104)</b>
DCM	125204	Area-Length Biplane
DCM	125205	Area-Length Single Plane
DCM	125211	Biplane Ellipse
DCM	125226	Single Plane Ellipse
DCM	125206	Cube Method
DCM	125207	Method of Disks, Biplane
DCM	125208	Method of Disks, Single Plane
DCM	125209	Teichholz

**CID 12229 Area Methods**

**Context ID 12229  
Area Methods**

**Type: Extensible Version: 20030918**

<b>Coding Scheme Designator (0008,0102)</b>	<b>Code Value (0008,0100)</b>	<b>Code Meaning (0008,0104)</b>
DCM	125210	Area by Pressure Half-Time

<b>Coding Scheme Designator (0008,0102)</b>	<b>Code Value (0008,0100)</b>	<b>Code Meaning (0008,0104)</b>
DCM	125212	Continuity Equation
DCM	125213	Continuity Equation by Mean Velocity
DCM	125214	Continuity Equation by Peak Velocity
DCM	125215	Continuity Equation by Velocity Time Integral
DCM	125216	Proximal Isovelocity Surface Area
DCM	125220	Planimetry

**CID 12230 Gradient Methods**

**Context ID 12230  
Gradient Methods**

**Type: Extensible Version: 20030918**

<b>Coding Scheme Designator (0008,0102)</b>	<b>Code Value (0008,0100)</b>	<b>Code Meaning (0008,0104)</b>
DCM	125217	Full Bernoulli
DCM	125218	Simplified Bernoulli

**CID 12231 Volume Flow Methods**

**Context ID 12231  
Volume Flow Methods**

**Type: Extensible Version: 20030918**

<b>Coding Scheme Designator (0008,0102)</b>	<b>Code Value (0008,0100)</b>	<b>Code Meaning (0008,0104)</b>
DCM	125219	Doppler Volume Flow
DCM	125216	Proximal Isovelocity Surface Area

**CID 12232 Myocardium Mass Methods**

**Context ID 12232  
Myocardium Mass Methods**

**Type: Extensible Version: 20050321**

<b>Coding Scheme Designator (0008,0102)</b>	<b>Code Value (0008,0100)</b>	<b>Code Meaning (0008,0104)</b>
DCM	125221	Left Ventricle Mass by M-mode
DCM	125222	Left Ventricle Mass by Truncated Ellipse

**CID 12233 Cardiac Phase**

**Context ID 12233  
Cardiac Phase**

**Type: Extensible Version: 20030918**

<b>Coding Scheme Designator (0008,0102)</b>	<b>Code Value (0008,0100)</b>	<b>Code Meaning (0008,0104)</b>
SRT	F-32020	Systole
SRT	F-32010	Diastole
SRT	F-32011	End Diastole
DCM	109070	End Systole

**CID 12234 Respiration State**

**Context ID 12234  
Respiration Phase**

**Type: Extensible Version: 20030918**

<b>Coding Scheme Designator (0008,0102)</b>	<b>Code Value (0008,0100)</b>	<b>Code Meaning (0008,0104)</b>
SRT	F-20010	During Inspiration
SRT	F-20020	During Expiration

**CID 12235 Mitral Valve Anatomic Sites**

**Context ID 12235  
Mitral Valve Anatomic Sites**

**Type: Extensible Version: 20040614**

<b>Coding Scheme Designator (0008,0102)</b>	<b>Code Value (0008,0100)</b>	<b>Code Meaning (0008,0104)</b>
SRT	G-0391	Medial Mitral Annulus
SRT	G-0392	Lateral Mitral Annulus
SRT	T-35313	Mitral Annulus

**CID 12236 Echo Anatomic Sites**

**Context ID 12236  
Echo Anatomic Sites**

**Type: Extensible Version: 20050321**

<b>Coding Scheme Designator (0008,0102)</b>	<b>Code Value (0008,0100)</b>	<b>Code Meaning (0008,0104)</b>
INCLUDE CID 12235 Mitral Valve Anatomic Sites		
INCLUDE CID 12223 Stroke Volume Origin		
INCLUDE CID 12241 Tricuspid Valve Finding Sites		
INCLUDE CID 12242 Aortic Valve Finding Sites		

<b>Coding Scheme Designator (0008,0102)</b>	<b>Code Value (0008,0100)</b>	<b>Code Meaning (0008,0104)</b>
INCLUDE CID 12243 Left Ventricle Finding Sites		
INCLUDE CID 12244 Congenital Finding Sites		
SRT	D4-32030	Thoracic Aortic Coarctation

**CID 12237 Echocardiography Anatomic Site Modifiers**  
Type: Extensible Version: 20030918

**Context ID 12237**  
**Echocardiography Anatomic Site Modifiers**  
Type: Extensible Version: 20030918

<b>Coding Scheme Designator (0008,0102)</b>	<b>Code Value (0008,0100)</b>	<b>Code Meaning (0008,0104)</b>
INCLUDE CID 12219 Pulmonary Vein Modifiers		

**CID 12238 Wall Motion Scoring Schemes**

**Context ID 12238**  
**Wall Motion Scoring Schemes**  
Type: Extensible Version: 20050321

<b>Coding Scheme Designator (0008,0102)</b>	<b>Code Value (0008,0100)</b>	<b>Code Meaning (0008,0104)</b>
DCM	125223	4 Point Segment Finding Scale
DCM	125224	5 Point Segment Finding Scale
DCM	125225	5 Point Segment Finding Scale With Graded Hypokinesis

**CID 12239 Cardiac Output Properties**

**Context ID 12239**  
**Cardiac Output Properties**  
Type: Extensible Version: 20030918

<b>Coding Scheme Designator (0008,0102)</b>	<b>Code Value (0008,0100)</b>	<b>Code Meaning (0008,0104)</b>
SRT	F-32120	Stroke Volume
SRT	F-32100	Cardiac Output
SRT	F-32110	Cardiac Index
SRT	F-00078	Stroke Index

**CID 12240 Left Ventricle Area**

**Context ID 12240  
Left Ventricle Area**

**Type: Extensible Version: 20030918**

<b>Coding Scheme Designator (0008,0102)</b>	<b>Code Value (0008,0100)</b>	<b>Code Meaning (0008,0104)</b>
SRT	G-0374	Left Ventricular Systolic Area
SRT	G-0375	Left Ventricular Diastolic Area
SRT	G-0376	Left Ventricular Fractional Area Change
SRT	G-0379	Left Ventricle Epicardial Diastolic Area, psax pap view

**CID 12241 Tricuspid Valve Finding Sites**

**CID 12241  
Tricuspid Valve Finding Sites**

**Type: Extensible Version: 20040614**

<b>Coding Scheme Designator (0008,0102)</b>	<b>Code Value (0008,0100)</b>	<b>Code Meaning (0008,0104)</b>
SRT	T-35111	Tricuspid Annulus

**CID 12242 Aortic Valve Finding Sites**

**CID 12242  
Aortic Valve Finding Sites**

**Type: Extensible Version: 20040614**

<b>Coding Scheme Designator (0008,0102)</b>	<b>Code Value (0008,0100)</b>	<b>Code Meaning (0008,0104)</b>
SRT	T-35410	Aortic Valve Ring

**CID 12243 Left Ventricle Finding Sites**

**CID 12243  
Left Ventricle Finding Sites**

**Type: Extensible Version: 20040614**

<b>Coding Scheme Designator (0008,0102)</b>	<b>Code Value (0008,0100)</b>	<b>Code Meaning (0008,0104)</b>
SRT	T-32650	Left Ventricle Outflow Tract

**CID 12244 Congenital Finding Sites**

**CID 12244  
Congenital Finding Sites**

**Type: Extensible Version: 20040614**

<b>Coding Scheme Designator (0008,0102)</b>	<b>Code Value (0008,0100)</b>	<b>Code Meaning (0008,0104)</b>
SRT	D4-31150	Ventricular Septal Defect
SRT	D4-31220	Atrial Septal Defect



**Annex C Acquisition and Protocol Context Templates (Normative)**

This Annex specifies the content of Templates for Acquisition and Protocol Context required by DICOM IODs.

**TEMPLATES**

**TID 3401 ECG Acquisition Context**

**TID 3401  
ECG Acquisition Context**

	<b>VT</b>	<b>Concept Name</b>	<b>VM</b>	<b>Req Type</b>	<b>Condition</b>	<b>Value Set Constraint</b>
1	CODE	(5.4.5-33-1, SCPECG, 1.3, "Electrode Placement")	1	U		BCID(3263)
2	CODE	(109054, DCM, "Patient State")	1	U		BCID(3262)
3	NUM	(109055, DCM, "Protocol Stage")	1	U		UNITS=EV("{stage}", UCUM, "stage")
4	CODE	(109056, DCM, "Stress Protocol")	1	U		BCID(3261)
5	CODE	(5.4.5-33-2, SCPECG, 1.3, "XYZ Electrode Configuration")	1	U		BCID(3264)

**TID 3403 Catheterization Acquisition Context**

**TID 3403  
Catheterization Acquisition Context**

	<b>VT</b>	<b>Concept Name</b>	<b>VM</b>	<b>Req Type</b>	<b>Condition</b>	<b>Value Set Constraint</b>
1	CODE	(G-72BB, SRT, "Catheterization Procedure Phase")	1	U		BCID(3250) Catheterization Procedure Phase
2	CODE	(109058, DCM, "Contrast Phase")	1	U		BCID(3600) <u>Relative time</u>
3	CODE	(109059, DCM, "Physiological challenges")	1	U		BCID(3271) Hemodynamic Physiological Challenges
4	NUM	(109060, DCM, "Procedure Step Number")	1	U		UNITS=EV("{step}", UCUM, "step")
5	TEXT	EV (121124, DCM, "Procedure Action ID")	1	U		

Note: See TID 3100 in Annex A for description of Procedure Action ID used in Row 5.

**TID 3450 Cardiac Electrophysiology Acquisition Context**

**TID 3450  
Cardiac Electrophysiology Acquisition Context**

	<b>VT</b>	<b>Concept Name</b>	<b>VM</b>	<b>Req Type</b>	<b>Condition</b>	<b>Value Set Constraint</b>
1	CODE	(109061, DCM, "EP Procedure Phase")	1	U		BCID(3254)
2	NUM	(109060, DCM, "Procedure Step Number")	1	U		UNITS=EV("{step}", UCUM, "step")

	VT	Concept Name	VM	Req Type	Condition	Value Set Constraint
3	TEXT	(109063,DCM,"Pulse train definition")	1	U		

**TID 3470 NM Acquisition Context**

**TID 3470  
NM Acquisition Context**

	VT	Concept Name	V M	Req Type	Condition	Value Set Constraint
1	CODE	(109054, DCM, "Patient State")	1	M		DCID (3101) NM Procedural State Values

**TID 15100 Contrast Agent/Pre-Medication Protocol Context**

This Template specifies medications to be administered prior to a diagnostic imaging protocol, imaging contrast agents to be used in the protocol, and/or bolus agents to be used in the protocol. Each medication or agent may be modified by a specified route of administration.

**Type: Extensible**

**TID 15100  
Contrast Agent/Pre-Medication Protocol Context**

	NL	VT	Concept Name	VM	Req Type	Condition	Value Set Constraint
1		CODE	EV (123011, DCM, "Contrast/Bolus Agent")	1-n	U		BCID 12
2	>	CODE	EV (G-C340, SRT, "Route of Administration")	1	U		BCID 11
3		CODE	EV (123012, DCM, "Pre-Medication")	1-n	U		
4	>	CODE	EV (G-C340, SRT, "Route of Administration")	1	U		BCID 11

**TID 15101 NM/PET Protocol Context**

**Type: Extensible**

**TID 15101  
NM/PET Protocol Context**

	NL	VT	Concept Name	VM	Req Type	Condition	Value Set Constraint
1		CODE	EV (123001, DCM, "Radiopharmaceutical")	1	M		BCID 25 (NM) or 4021 (PET)
2	>	CODE	EV (C-B1000, SRT, "Diagnostic Radioisotope")	1	U		BCID 18 (NM) or 4020 (PET)
3	>	DATETIME	EV (123003, DCM, "Radiopharmaceutical Start Time")	1	U		
4	>	DATETIME	EV (123004, DCM, "Radiopharmaceutical Stop Time")	1	U		

	NL	VT	Concept Name	VM	Req Type	Condition	Value Set Constraint
5	>	NUMERIC	EV (123005, DCM, "Radiopharmaceutical Volume")	1	U		Units = DT(cm3, UCUM, "cm3")
6	>	NUMERIC	EV (123006, DCM, "Radionuclide Total Dose")	1	U		Units = DT(Bq, UCUM, "Bq")
7	>	NUMERIC	EV (123007, DCM, "Radiopharmaceutical Specific Activity")	1	U		Units = DT(Bq/mol, UCUM, "Bq/mol")
8	>	CODE	EV (G-C340, SRT, "Route of Administration")	1	U		BCID 11
9	>	NUMERIC	EV (123009, DCM, "Radionuclide Syringe Counts")	1	U		Units = DT({counts}/s, UCUM "counts/s")
10	>	NUMERIC	EV (123010, DCM, "Radionuclide Residual Syringe Counts")	1	U		Units = DT({counts}/s, UCUM "counts/s")

**TID 15200 JJ1017 Protocol Context**

This Template defines protocol context concepts to support the requirements of Japanese Guideline JJ1017. This is expected to be used with Scheduled or Performed Protocol Codes from Coding Scheme JJ1017-16M defined in Guideline JJ1017.

**Type: Extensible**

**TID 15200  
JJ1017 Protocol Context**

	NL	VT	Concept Name	VM	Req Type	Condition	Value Set Constraint
1		CODE	EV (123016, DCM, "Imaging Conditions")	1	M		Baseline terms from Coding Scheme JJ1017-16S of JJ1017 version 3.0

**Annex D DICOM Controlled Terminology Definitions (Normative)**

This Annex specifies the meanings of codes defined in DICOM, either explicitly or by reference to another part of DICOM or an external reference document or standard.

**DICOM Code Definitions (Coding Scheme Designator “DCM” Coding Scheme Version “01”)**

<b>Code Value</b>	<b>Code Meaning</b>	<b>Definition</b>	<b>Notes</b>
109001	Digital timecode (NOS)	A signal transmitted for the purpose of interchange of the current time, not specific to any source or methodology.	
109002	ECG-based gating signal, processed	A signal which is generated for each detection of a heart beat	
109003	IRIG-B timecode	A signal transmitted by the Inter-Range Instrumentation Group for the purpose of synchronizing time clocks.	
109004	X-ray Fluoroscopy On Signal	A signal which indicates that X-ray source has been activated for fluoroscopy use.	
109005	X-ray On Trigger	A signal that indicated that the X-ray source has been activated for image recording.	
109006	Differential signal	An electrical signal derived from two electrodes	
109007	His bundle electrogram	An electrophysiological recording from the HIS nerve bundle	
109008	Monopole signal	An electrical signal from one electrode relative to an indifferent potential.	
109009	Pacing (electrical) stimulus, voltage	The voltage stimulus during cardiac pacing	
109010	Radio frequency ablation, power	The power injected during RF ablation procedure	
109011	Voltage measurement by basket catheter	Electrophysiological signals acquired using a multi-splined catheter each equipped with multiple electrodes.	
109012	Voltage measurement by mapping catheter	Electrophysiological signals acquired using a steerable catheter	
109013	Voltage measurement, NOS	A voltage measurement not otherwise specified	
109014	35% of thermal CO	A signal point which is 35% of the peak thermal cardiac output	

		signal	
109015	70% of thermal CO	A signal point which is 70% of the peak thermal cardiac output signal	
109016	A wave peak pressure	The peak pressure of each heart beat in the atrium caused by the atrial contraction	
109017	A wave pressure, average	The average of several A wave pressure measurements	
109018	Beat detected (accepted)	An identified cardiac beat used in the determination of a measurement	
109019	Beat detected (rejected)	An identified cardiac beat not used in the determination of a measurement	
109020	<i>Diastolic pressure, average</i>	<i>The average of several diastolic pressure measurements</i>	<i>Retired. Replaced with (F-00E22, SRT, "Average diastolic blood pressure")</i>
109021	<i>Diastolic pressure nadir</i>	<i>The lowest pressure value excluding any undershoot artifact.</i>	<i>Retired. Replaced with (F-00E1F, SRT, "Minimum diastolic blood pressure")</i>
109022	<i>End diastole</i>	<i>The moment at the end of the diastolic phase of the cardiac cycle.</i>	<i>Retired. Replaced with (F-32011, SRT, "End diastole")</i>
109023	End of expiration	The moment at the end of respiratory expiration	
109024	End of inspiration	The moment at the end of respiratory inspiration	
109025	Max dp/dt	The maximum positive rate of change of pressure.	
109026	Max neg dp/dt	The maximum negative rate of change of pressure.	
109027	<i>Mean blood pressure</i>	<i>The average blood pressure value, generally over 2 or more seconds</i>	<i>Retired. Replaced with (F-31150, SRT, "Mean blood pressure")</i>
109028	Peak of thermal cardiac output bolus	The peak change in blood temperature during a thermal cardiac output measurement.	
109029	Start of expiration	The moment respiratory expiration begins	
109030	Start of inspiration	The moment of respiratory inspiration begins	
109031	Start of thermal cardiac output bolus	The first discernable blood temperature change following the injectate during a thermal cardiac output measurement	
109032	<i>Systolic pressure, average</i>	<i>The average of several systolic blood pressure measurements.</i>	<i>Retired. Replaced with (F-00E14, SRT, "Average systolic blood pressure")</i>

109033	Systolic peak pressure	The highest systolic blood pressure value excluding any overshoot artifact	Retired. Replaced with (F-00E11, SRT, "Maximum systolic blood pressure")
109034	V wave peak pressure	The peak pressure of each heart beat in the atrium caused by the filling of the atrium.	
109035	V wave pressure, average	The average of several V wave pressure measurements	
109036	Valve close	The moment at which a heart valve closes	
109037	Valve open	The moment at which a heart valve opens	
109038	Ablation off	The moment when RF ablation current is turned off.	
109039	Ablation on	The moment when RF ablation current is turned on	
109040	HIS bundle wave	The moment in the cardiac cycle when the HIS bundle nerves depolarize.	
109041	P wave	The surface electrocardiogram of the atrial contraction	
109042	Q wave	The first negative deflection of the electrocardiogram cause by ventricular depolarization	
109043	R wave	The first positive deflection the electrocardiogram cause by ventricular depolarization	
109044	S wave	The first negative deflection after the R wave.	
109045	Start of atrial contraction	The beginning of the atrial contraction	
109046	Start of atrial contraction (subsequent)	The beginning of the second atrial contraction of two consecutive beats.	
109047	Stimulation at rate 1 interval	The stimulation interval during cardiac stimulation first used in a pacing train	
109048	Stimulation at rate 2 interval	The stimulation interval different from the first stimulation interval used in a pacing train	
109049	Stimulation at rate 3 interval	A stimulation interval different from and subsequent to the second interval in a pacing train.	
109050	Stimulation at rate 4 interval	Describes a stimulation interval different from and subsequent to the third interval in a pacing train	
109051	T wave	The electrocardiogram deflection caused by ventricular repolarization.	

109052	V wave	The peak pressure of each heart beat monitored in the atrium caused by the filling of the atrium	
109053	V wave of next beat	The second V wave measurement of two consecutive beats.	
109054	Patient State	A description of the physiological condition of the patient	
109055	Protocol Stage	The exercise level during a progressive cardiac stress test.	
109056	Stress Protocol	A series of physiological challenges designed to progressively increase the work of the heart.	
109057	<i>Catheterization Procedure Phase</i>	<i>A subpart of a cardiac catheterization procedure</i>	<i>Retired. Replaced with (G 72BB, SRT, "Catheterization Procedure Phase")</i>
109058	Contrast Phase	The subpart of a cardiac catheterization procedure in which a radio-opaque contrast medium is injected into the patient.	
109059	Physiological challenges	Physical changes administered to a patient in order to elicit an physiological response	
109060	Procedure Step Number	Enumeration of a subpart of a catheterization procedure	
109061	EP Procedure Phase	A subpart of an electrophysiological procedure	
109063	Pulse train definition	A means of defining a series of cardiac stimulation pulses	
109070	End of systole		
109071	Indicator mean transit time	Time for a median particle to travel from point of injection to point of detection	
109072	Tau	The time constant of isovolumic pressure fall	
109073	V max myocardial	Maximum velocity of myocardial contractility	
109091	Cardiac Stress State	Imaging after injection of tracer during increased cardiac workload or increased myocardial blood flow, achieved by either exercise or pharmacologic means.	
109092	Reinjection State	Imaging after injection of additional tracer under resting conditions.	
109093	Redistribution State	Imaging after allowing a	

		<p>moderate amount of time for tracer to move from its initial sites of uptake.</p> <p>Example: For Thallium imaging this would correspond to imaging 2-6 hours after injection.</p>	
109094	Delayed Redistribution State	<p>Imaging after allowing an extended amount of time for tracer to move from its initial sites of uptake.</p> <p>Example: For Thallium imaging this would correspond to imaging more than 6 hours after injection.</p>	
109101	Acquisition Equipment	Equipment that originally acquired the data stored within composite instances. For example, a CT, MR or Ultrasound modality.	
109102	Processing Equipment	Equipment that has processed composite instances to create new composite instances. For example, a 3D Workstation.	
109103	Modifying Equipment	Equipment that has modified existing composite instances (without creating new composite instances). For example, a QA Station or Archive.	
109110	Voice	The sound of a human's speech, recorded during a procedure.	May include the patient's voice, or the voice of staff present in the room, or an operator's voice (whether for the purpose of recording a narrative accompanying a procedure or not).
109111	Operator's narrative	The voice of a device operator, recorded during a procedure.	
109112	Ambient room environment	The ambient sound recorded during a procedure, which may or may not include voice and other types of sound.	
109113	Doppler audio	The Doppler waveform recorded as an audible signal.	
109114	Phonocardiogram	The sound of the human heart beating.	Such as might be recorded from an electronic stethoscope.
109115	Physiological audio signal	Any sound made by the human body.	May include the sound of the heart, but also sound from other organs, such as bowel sounds or bruits from vessels, or sounds of respiration. Not intended



			to include voice.
109120	On admission to unit	The occasion on which a procedure was performed on admission to a specialist unit (e.g., intensive care).	
109121	On discharge	The occasion on which a procedure was performed on discharge from hospital as an in-patient.	
109122	On discharge from unit	The occasion on which a procedure was performed on discharge from a specialist unit (e.g., intensive care).	
109123	Pre-intervention	The occasion on which a procedure was performed immediately prior to non-surgical intervention (e.g, percutaneous angioplasty, biopsy).	
109124	Post-intervention	The occasion on which a procedure was performed immediately after to non-surgical intervention (e.g, percutaneous angioplasty, biopsy).	
109125	At last appointment	The occasion on which a procedure was performed at the most recent outpatient visit.	
109200	America Kennel Club	America Kennel Club	
109201	America's Pet Registry Inc.	America's Pet Registry Inc.	
109202	American Canine Association	American Canine Association	
109203	American Purebred Registry	American Purebred Registry	
109204	American Rare Breed Association	American Rare Breed Association	
109205	Animal Registry Unlimited	Animal Registry Unlimited	
109206	Animal Research Foundation	Animal Research Foundation	
109207	Canadian Border Collie Association	Canadian Border Collie Association	
109208	Canadian Kennel Club	Canadian Kennel Club	
109209	Canadian Livestock Records Association	Canadian Livestock Records Association	
109210	Canine Federation of Canada	Canine Federation of Canada	
109211	Continental Kennel Club	Continental Kennel Club	

109212	Dog Registry of America	Dog Registry of America	
109213	Federation of International Canines	Federation of International Canines	
109214	International Progressive Dog Breeders' Alliance	International Progressive Dog Breeders' Alliance	
109215	National Kennel Club	National Kennel Club	
109216	North American Purebred Dog Registry	North American Purebred Dog Registry	
109217	United All Breed Registry	United All Breed Registry	
109218	United Kennel Club	United Kennel Club	
109219	Universal Kennel Club International	Universal Kennel Club International	
109220	Working Canine Association of Canada	Working Canine Association of Canada	
109221	World Kennel Club	World Kennel Club	
109222	World Wide Kennel Club	World Wide Kennel Club	
110020	Sheet Film Digitized	Digitization of Sheet Film	
110021	Cine Film Digitized	Digitization of Cine Film	
110022	Video Tape Digitized	Digitization of Video Tape	
110023	Paper Digitized	Digitization of pages of a paper document (Units may be specified as Pages, Documents)	
110024	CD Imported	Importation of CD	
110025	DVD Imported	Importation of DVD	
110026	MOD Imported	Importation of MOD	
110027	Studies Imported	Importation of DICOM Studies	
110028	Instances Imported	Importation of DICOM Composite Instances	
110500	Doctor cancelled procedure	Procedure order cancelled by requesting physician or other authorized physician	
110501	Equipment failure	Equipment failure prevented completion of procedure	
110502	Incorrect procedure ordered	Procedure discontinued due to incorrect procedure being ordered	
110503	Patient allergic to media/contrast	Procedure discontinued due to patient allergy to media/contrast (reported or reaction)	
110504	Patient died	Procedure discontinued due to death of Patient	

110505	Patient refused to continue procedure	Procedure discontinued due to patient refusal to continue procedure	
110506	Patient taken for treatment or surgery	Procedure discontinued due to patient being taken for treatment or surgery	
110507	Patient did not arrive	Patient did not arrive for procedure	
110508	Patient pregnant	Procedure discontinued due to patient pregnancy (reported or determined)	
110509	Change of procedure for correct charging	Procedure discontinued to restart with new procedure code for correct charging	
110510	Duplicate order	Procedure discontinued due to duplicate orders received for same procedure	
110511	Nursing unit cancel	Procedure order cancelled by nursing unit	
110512	Incorrect side ordered	Procedure discontinued due to incorrect side (laterality) being ordered	
110513	Discontinued for unspecified reason	Procedure discontinued for unspecified reason	
110514	Incorrect worklist entry selected	Procedure discontinued due to incorrect patient or procedure step selected from modality worklist	
110515	Patient condition prevented continuing	Patient condition prevented continuation of procedure	
110516	Equipment change	Procedure step is discontinued to change to other equipment or modality	
110521	Objects incorrectly formatted	One or more of the objects is malformed.	
110522	Object Types not supported	Receiving System is unable to accept the object type.	
110523	Object Set incomplete	One or more objects associated with the object set is missing.	
110524	Media Failure	The contents of the Media could not be accessed properly.	
110001	Image Processing	Image processing work item	
110002	Quality Control	Quality control work item	
110003	Computer Aided Diagnosis	Computer aided diagnosis work item	
110004	Computer Aided Detection	Computer aided detection work item	
110005	Interpretation	Interpretation work item	

110006	Transcription	Transcription work item	
110007	Report Verification	Report verification work item	
110008	Print	Print work item	
110009	No subsequent Workitems		
110010	Film	Film type of output	
110011	Dictation	Dictation type of output	
110012	Transcription	Transcription type of output	
110013	Media Import	The procedure to read DICOM instances from DICOM interchange media, coerce identifying attributes into the local namespace if necessary, and make the instances available.	
111001	Algorithm Name	The name assigned by a manufacturer to a specific software algorithm	
111002	Algorithm Parameters	The input parameters used by a manufacturer to configure the behavior of a specific software algorithm	
111003	Algorithm Version	The software version identifier assigned by a manufacturer to a specific software algorithm	
111004	Analysis Performed	The type of correlation applied to detection results (e.g., temporal, spatial)	
111005	Assessment Category	Assignment of intermediate or overall interpretation results to a general category	
111006	<i>Breast composition</i>	<i>Assessment of annotating tissues in breast; generally including fatty, mixed or dense</i>	<i>Retired. Replaced with (F-01710, SRT 1.1, "Breast composition").</i>
111007	Breast Outline including Pectoral Muscle Tissue	Purpose of reference for an SCOORD content item that is an outline of the breast that includes the pectoral muscle tissue	Purpose of Reference for content item of value type COMPOSITE or SCOORD
111008	Calcification Distribution	The type of distribution associated with detected calcifications	
111009	Calcification Type	Identification of the morphology of detected calcifications	
111010	Center	Purpose of reference for an SCOORD content item that identifies the central point of a finding or feature	Purpose of Reference for content item of value type COMPOSITE or SCOORD
111011	Certainty of Feature	The likelihood that the feature	

		analyzed is in fact the type of feature identified.	
111012	Certainty of Finding	The likelihood that the finding detected is in fact the type of finding identified.	
111013	Certainty of Impression	The certainty that a device places on an impression, where 0 equals no certainty and 100 equals certainty.	
111014	Clockface or region	A location identifier based on clockface numbering or anatomic subregion	
111015	Composite Feature	An item that is an inferred correlation relating two or more individual findings or features	
111016	Composite type	The inferred relationship between the findings or features making up a composite feature	
111017	CAD Processing and Findings Summary	General assessment of whether or not CAD processing was successful, and whether any findings resulted	
111018	Content Date	The date the data creation started	
111019	Content Time	The time the data creation started	
111020	Depth	A location identifier based on a feature's inferred distance from the surface of the associated anatomy	
111021	Description of Change	A textual description of the change that occurred over time in a qualitative characteristic of a feature	
111022	Detection Performed	The type of finding sought after by a specific algorithm applied to one image	
111023	Differential Diagnosis/Impression	A general change that occurred within an imaged area between a prior imaging procedure and the current imaging procedure	
111024	Failed Analyses	A group of analysis algorithms that were attempted, but failed	
111025	Failed Detections	A group of detection algorithms that were attempted, but failed	
111026	Horizontal Pixel Spacing	For projection radiography, the horizontal physical distance measured at the front plane of an Image Receptor housing between the center of each pixel. For tomographic images,	

		the horizontal physical distance in the patient between the center of each pixel.	
111027	Image Laterality	Laterality of (possibly paired) body part contained in an image	
111028	Image Library	A container that references all image data used as evidence to produce a report	
111029	Image Quality Rating	A numeric value in the range 0 to 100, inclusive, where 0 is worst quality and 100 is best quality.	
111030	Image Region	Purpose of reference for an SCOORD content item that identifies a specific region of interest within an image	Purpose of Reference for content item of value type COMPOSITE or SCOORD
111031	Image View	The projection of the anatomic region of interest on an image receptor.	
111032	Image View Modifier	Modifier for Image View	
111033	Impression Description	Free-form text describing the overall or an individual impression	
111034	Individual Impression/Recommendation	A container for a group of related results from interpretation of one or more images and associated clinical information	
111035	Lesion Density	The x-ray attenuation of a lesion relative to the expected attenuation of an equal volume of fibroglandular breast tissue	
111036	Mammography CAD Report	A structured report containing the results of computer-aided detection or diagnosis applied to breast imaging and associated clinical information	
111037	Margins	The characteristic of the boundary, edges or border of a detected lesion	
111038	Number of calcifications	The quantity of calcifications detected within an identified group or cluster	
111039	Object type	A non-lesion object identified within one or more images	
111040	Original Source	Purpose of reference for a COMPOSITE content item that identifies it as the original source of evidence for another content item in the report	Purpose of Reference for content item of value type COMPOSITE or SCOORD
111041	Outline	Purpose of reference for an SCOORD content item that	Purpose of Reference for content item of value type

		identifies the outline or bounding region of a finding or feature	COMPOSITE or SCOORD
111042	Pathology	The inferred type of disease associated with an identified feature	
111043	Patient Orientation Column	The patient orientation relative to the image plane, specified by a value that designates the anatomical direction of the positive column axis (top to bottom)	
111044	Patient Orientation Row	The patient orientation relative to the image plane, specified by a value that designates the anatomical direction of the positive row axis (left to right)	
111045	Pectoral Muscle Outline	Purpose of reference for an SCOORD content item that is an outline of the pectoral muscle tissue only	Purpose of Reference for content item of value type COMPOSITE or SCOORD
111046	Percent Glandular Tissue	Percent of breast area that is mammographically dense.	
111047	Probability of cancer	The likelihood that an identified finding or feature is cancerous	
111048	Quadrant location	A location identifier based on the division of an area into four regions	
111049	Qualitative Difference	A qualitative characteristic of a feature that has changed over time	
111050	Quality Assessment	The effect of the quality of an image on its usability	
111051	Quality Control Standard	The quality control standard used to make a quality assessment	
111052	Quality Finding	A specific quality related deficiency detected within an image	
111053	Recommended Follow-up	Recommended type of follow-up to an imaging procedure, based on interpreted results	
111054	Recommended Follow-up Date	Recommended follow-up date to an imaging procedure, based on interpreted results	
111055	Recommended Follow-up Interval	Recommended follow-up interval to an imaging procedure, based on interpreted results	
111056	Rendering Intent	The recommendation of the producer of a content item regarding presentation of the content item by recipients of the	

		report	
111057	Scope of Feature	An indication of how widespread the detection of a feature is within the analyzed image data set	
111058	Selected Region Description	A textual description of the contents of a selected region identified within an image	
111059	Single Image Finding	An item that was detected on one image	
111060	Study Date	Date on which the acquisition of the study information was started	
111061	Study Time	Time at which the acquisition of the study information was started	
111062	Successful Analyses	A group of analysis algorithms that were attempted and completed successfully	
111063	Successful Detections	A group of detection algorithms that were attempted and completed successfully	
111064	Summary of Detections	An overall indication of whether the CAD detection algorithms applied were completed successfully	
111065	Summary of Analyses	An overall indication of whether the CAD analysis algorithms applied were completed successfully	
111066	Vertical Pixel Spacing	For projection radiography, the vertical physical distance measured at the front plane of an Image Receptor housing between the center of each pixel. For tomographic images, the vertical physical distance in the patient between the center of each pixel.	
111071	CAD Operating Point	One of a number of discrete points on the Receiver-Operator Characteristics (ROC) curve that reflects the expected sensitivity and specificity of a CAD algorithm, where zero indicates the highest specificity, lowest sensitivity operating point. The value should not exceed the Maximum CAD Operating Point.	
111072	Maximum CAD Operating Point	The maximum value of CAD Operating Point for the specific CAD algorithm used.	



111081	CAD Operating Point Description	The intended interpretation of a CAD Operating Point.	
111086	False Markers per Image	The number of false CAD markers per image.	
111087	False Markers per Case	The number of false markers per collection of images that are CAD processed as a group.	
111088	Case Sensitivity	The percentage of cancers that should be detected by a CAD algorithm where CAD marks the cancers in at least one view.	
111089	Lesion Sensitivity	The percentage of cancers that should be detected by a CAD algorithm where CAD marks the cancers in each view.	
111090	Case Specificity	The percentage of cases (collections of images CAD processed as a group) without cancer that have no CAD findings whatsoever.	
111091	Image Specificity	The percentage of images without cancer that have no CAD findings whatsoever.	
111092	Recommended CAD Operating Point	The CAD operating point that is recommended for initial display by the creator of the structured report.	
111093	CAD Operating Point Table	A list of CAD operating points including their corresponding characteristics.	
111099	Selected region	A specific area of interest noted within an image	
111100	Breast geometry	The surface shape of all or a portion of breast related anatomy	
111101	Image Quality	Image quality incorporates the following clinical image evaluation parameters: assessment of positioning, compression, artifacts, exposure, contrast, sharpness, and labeling	
111102	Non-lesion	A finding or feature that is identified as a non-anatomic foreign object	
111103	<i>Density</i>	<i>A space-occupying lesion identified in a single image or projection</i>	<i>Retired. Replaced with (F-01796, SRT 1.1, "Mammography breast density").</i>
111104	<i>Individual Calcification</i>	<i>A single identified calcification</i>	<i>Retired. Replaced with (F-01776, SRT 1.1,</i>

			<i>"Individual Calcification"</i> ).
111105	<i>Calcification Cluster</i>	<i>Multiple calcifications identified as occupying a small area of tissue (less than 2 cc)</i>	<i>Retired. Replaced with (F-01775, SRT 1.1, "Calcification Cluster").</i>
111111	Cooper's ligament changes	Straightening or thickening of Cooper's ligaments	
111112	Mass in the skin	An abnormality noted at imaging within the dermis of the breast	
111113	Mass on the skin	An abnormality noted at imaging on the epidermis of the breast	
111120	Post Procedure Mammograms for Marker Placement	An assessment category to indicate that images have been acquired to assess marker placement following a breast interventional procedure	
111121	Follow-up post biopsy as directed by clinician	An indication that the patient should seek post procedural follow-up directives from a clinical health care provider.	
111122	Known biopsy proven malignancy – take appropriate action	A recommendation on a patient with known cancer to take steps appropriate to the diagnosis.	
111123	Clip placement	Positioning of a radiopaque marker.	
111124	Personal history of breast cancer with mastectomy	Patient has previous diagnosis of breast cancer resulting in mastectomy.	
111125	Known biopsy proven malignancy	Patient has had biopsy containing proven malignancy.	
111126	Image detected mass	Patient has a finding of mass reported on a prior imaging exam.	
111127	Targeted	A breast imaging procedure performed on a specific area of the breast.	
111128	Survey	A breast imaging procedure performed on the entire breast.	
111129	Clustered microcysts	A cluster of tiny anechoic foci each smaller than 2-3 mm in diameter with thin (less than 0.5 mm) intervening septations and no discrete solid components	
111130	Complicated cyst	A fluid filled mass most commonly characterized by homogeneous low-level internal echoes on ultrasound	
111135	Additional projections	Views not inclusive of MLO and CC (BI-RADS® )	
111136	Spot magnification view(s)	A spot or coned down compression of the breast	

		providing a reduction in the thickness and a magnification of the localized area of interest and improved separation of breast tissue	
111137	<i>Ultrasound</i>		<i>Retired. Replaced with (P5-B0099, SRT 1.1, "Ultrasound procedure").</i>
111138	Old films for comparison	Obtain previous mammography studies to compare to present study	
111139	<i>Ductography</i>	<i>A medical procedure used for the sampling of mammary duct tissue</i>	<i>Retired. Replaced with (P5-40060, SRT 1.1, "Mammary ductogram").</i>
111140	Normal interval follow-up	Follow up study at 12 months for women $\geq$ 40 years of age having a prior negative study and no mitigating risk factors for breast cancer	
111141	Any decision to biopsy should be based on clinical assessment	Any decision to perform tissue acquisition should be based on clinical assessment	
111142	Follow-up at short interval (1-11 months)	Follow-up at short interval (1-11 months)	
111143	Biopsy should be considered	Tissue acquisition should be considered	
111144	Needle localization and biopsy	Breast tissue acquisition following the identification of an area of concern with the placement of a needle or needle-wire assembly	
111145	Histology using core biopsy	Pathologic analysis of breast tissue and lesions using core tissue samples	
111146	Suggestive of malignancy – take appropriate action	Lesions that do not have the characteristic morphologies of breast cancer but have a definite probability of being malignant. There is a sufficient concern to urge a biopsy.	
111147	Cytologic analysis	Cellular analysis of specimen	
111148	Biopsy should be strongly considered	Tissue acquisition should be strongly considered	
111149	Highly suggestive of malignancy – take appropriate action	Lesions have a high probability of being cancer, which require additional action.	
111150	Presentation Required: Rendering device is expected to	The producer of a report intends for a recipient of the report to present or display the associated	

	present	content item	
111151	Presentation Optional: Rendering device may present	The producer of a report considers the presentation or display of the associated content item by a recipient to be optional	
111152	Not for Presentation: Rendering device expected not to present	The producer of a report intends for a recipient of the report NOT to present or display the associated content item	
111153	Target content items are related temporally	The associated content items are identified as being the same finding or feature at different points in time	
111154	Target content items are related spatially	The associated content items are identified as being the same finding or feature on different projections taken at the same point in time	
111155	Target content items are related contra-laterally	The associated content items are identified as being related side-to-side	
111156	Feature detected on the only image	There is one image in the interpreted data set	
111157	Feature detected on only one of the images	There is more than one image of the same modality in the interpreted data set	
111158	Feature detected on multiple images	There is more than one image of the same modality in the interpreted data set	
111159	Feature detected on images from multiple modalities	The interpreted data set contains images from multiple modalities	
111168	<i>Scar tissue</i>	<i>The fibrous tissue replacing normal tissues destroyed by disease or injury</i>	<i>Retired. Replaced with (M-78060, SNM3, "Scar tissue").</i>
111170	<i>J Wire</i>	<i>A medical appliance used for localization of non palpable breast lesions to insure that the proper area is removed in a surgical biopsy</i>	<i>Retired. Replaced with (A-1016B, SNM3, "J Wire").</i>
111171	<i>Pacemaker</i>	<i>A medical appliance used for regulating cardiac rhythms</i>	<i>Retired. Replaced with (A-11101, SNM3, "Pacemaker").</i>
111172	<i>Paddle</i>	<i>A compression device used for obtaining mammographic images</i>	<i>Retired. Replaced with (A-10042, SNM3, "Compression paddle").</i>
111173	<i>Collimator</i>	<i>A device used for restricting an X-Ray beam</i>	<i>Retired. Replaced with (A-10044, SNM3, "Collimator").</i>
111174	<i>ID Plate</i>	<i>An area designated on a radiographic film for facility and</i>	<i>Retired. Replaced with (A-16016, SNM3, "ID Plate").</i>

		<i>patient ID information</i>	
111175	Other Marker	Site specific markers	
111176	Unspecified	The value of the concept is not specified	
111177	View and Laterality Marker is missing	Image quality deficiency according to MQSA	
111178	View and Laterality Marker does not have both view and laterality	Image quality deficiency according to MQCM	
111179	View and Laterality Marker does not have approved codes	Image quality deficiency according to MQCM	
111180	View and Laterality Marker is not near the axilla	Image quality deficiency according to MQCM	
111181	View and Laterality Marker overlaps breast tissue	Image quality deficiency according to MQCM	
111182	View and Laterality Marker is partially obscured	Image quality deficiency according to MQCM	
111183	View and Laterality Marker is incorrect	Image quality deficiency	
111184	View and Laterality Marker is off image	Image quality deficiency	
111185	Flash is not near edge of film	Image quality deficiency according to MQCM	
111186	Flash is illegible, does not fit, or is lopsided	Image quality deficiency according to MQSA	
111187	Flash doesn't include patient name and additional patient id	Image quality deficiency according to MQCM	
111188	Flash doesn't include date of examination	Image quality deficiency according to MQCM	
111189	Flash doesn't include facility name and location	Image quality deficiency according to MQSA	
111190	Flash doesn't include technologist identification	Image quality deficiency according to MQCM	
111191	Flash doesn't include cassette/screen/detector identification	Image quality deficiency according to MQCM	
111192	Flash doesn't include mammography unit identification	Image quality deficiency according to MQCM	
111193	Date sticker is	Image quality deficiency	

	missing	according to MQCM	
111194	Technical factors missing	Image quality deficiency according to MQCM	
111195	Collimation too close to breast	Image quality deficiency according to MQCM	
111196	Inadequate compression	Image quality deficiency according to MQCM	
111197	MLO Insufficient pectoral muscle	Image quality deficiency according to MQCM	
111198	MLO No fat is visualized posterior to fibroglandular tissues	Image quality deficiency according to MQCM	
111199	MLO Poor separation of deep and superficial breast tissues	Image quality deficiency according to MQCM	
111200	MLO Evidence of motion blur	Image quality deficiency according to MQCM	
111201	MLO Inframammary fold is not open	Image quality deficiency according to MQCM	
111202	CC Not all medial tissue visualized	Image quality deficiency according to MQCM	
111203	CC Nipple not centered on image	Image quality deficiency according to MQCM	
111204	CC Posterior nipple line does not measure within 1 cm of MLO	Image quality deficiency according to MQCM	
111205	Nipple not in profile	Image quality deficiency	
111206	Insufficient implant displacement incorrect	Image quality deficiency according to MQCM	
111208	Grid artifact(s)	Feature(s) arising from the acquisition unit's anti-scatter grid mechanism. For two-dimensional systems, such features include those of mechanically damaged or incorrectly positioned grids. For moving or Bucky grids, artifacts may result from intentional grid motion that is inadequate in duration or velocity uniformity.	
111209	Positioning	Inadequate arrangement of the anatomy of interest with respect to the X-ray field and image detector sensitive area. Examples: 1) positioning is	

		"cutoff" when the projection of anatomy of interest falls outside the sensitive area of the detector; 2) "cone cut", in which the X-ray field does not adequately cover the anatomy of interest; 3) detector's sensitive surface is too small to cover the projection of the anatomy of interest; 4) improper angular orientation or "rotation" of anatomy of interest with respect to the X-ray source, or detector; 5) projection of other anatomy or clothing over the anatomy of interest in the image.	
111210	Motion blur	Unacceptable image blur resulting from motion of the anatomy of interest during exposure or the inadequately compensated motion of X-ray source with respect to the image detector during exposure.	
111211	Under exposed	Inadequate number of quanta reached the detector during exposure. Reasons for under exposed images include low kVp, low mAs product, excess Source Image Distance. Under exposed images have inadequate signal and higher noise in the areas of interest.	
111212	Over exposed	An excess number of quanta reached the detector during exposure. Reasons for over exposed images include high kVp, high mAs product, short Source Image Distance. Over exposed images have high signal and lower noise in the areas of interest. Over exposed area may demonstrate lack of contrast from over saturation of the detector.	
111213	No image	No evidence of a patient exposure.	
111214	Detector artifact(s)	Superposed features or flaws of the detector.	
111215	Artifact(s) other than grid or detector artifact	Features or discontinuities arising from causes other than the anti-scatter grid and image detector.	
111216	Mechanical failure	Failure of the device to operate according to mechanical design	

		specifications.	
111217	Electrical failure	Failure of a device to operate according to electrical design specifications	
111218	Software failure	Attributable to software used in generation or handling of image	
111219	Inappropriate image processing	Images processed inappropriately, not following appropriate protocol	
111220	Other failure	Failure that is not mechanical or electrical or otherwise described	
111221	Unknown failure	Unidentified or unknown cause of failure	
111222	Succeeded	The attempted process was completely successful	
111223	Partially Succeeded	The attempted process succeeded in some ways, but failed in others	
111224	Failed	The attempted process completely failed	
111225	Not Attempted	No process was performed	
111233	Individual Impression / Recommendation Analysis	Analysis of a related group of findings or features detected during image data inspection, to produce a summary impression and/or recommendation	
111234	Overall Impression / Recommendation Analysis	Analysis of all groups of findings or features, to produce a single impression and/or recommendation	
111235	Unusable — Quality renders image unusable	The usability of an image for diagnostic interpretation or CAD, based on a quality control standard	
111236	Usable — Does not meet the quality control standard	The usability of an image for diagnostic interpretation or CAD, based on a quality control standard	
111237	Usable — Meets the quality control standard	The usability of an image for diagnostic interpretation or CAD, based on a quality control standard	
111238	Mammography Quality Control Manual 1999, ACR	An image quality control standard specified by the American College of Radiology	
111239	Title 21 CFR Section 900, Subpart B	An image quality control standard in the US Code of Federal Regulations	
111240	Institutionally defined quality control	An image quality control standard specified or adopted by	



	standard	the institution responsible for the document	
111241	All algorithms succeeded; without findings	No findings resulted upon successful completion of all attempted computer-aided detection and/or analysis	
111242	All algorithms succeeded; with findings	One or more findings resulted upon successful completion of all attempted computer-aided detection and/or analysis	
111243	Not all algorithms succeeded; without findings	No findings resulted from the attempted computer-aided detection and/or analysis, but one or more failures occurred in the process	
111244	Not all algorithms succeeded; with findings	One or more findings resulted from the attempted computer-aided detection and/or analysis, but one or more failures occurred in the process	
111245	No algorithms succeeded; without findings	All of the attempted computer-aided detection and/or analysis failed, so there could be no findings	
111248	<i>Adenolipoma</i>	<i>A benign tumor having glandular characteristics but composed of fat, with the presence of normal mammary ducts</i>	<i>Retired. Replaced with (M-83240, SNM3, "Adenolipoma").</i>
111249	<i>Ductal hyperplasia</i>		<i>Retired. Replaced with (M-72170, SNM3, "Ductal hyperplasia, Usual").</i>
111250	<i>Adenomyoepithelioma</i>	<i>Neoplasms composed of myoepithelial cells</i>	<i>Retired. Replaced with (M-89830, SNM3, "Adenomyoepithelioma").</i>
111251	Normal axillary node	Axillary node that is normal in appearance with no associated pathology	
111252	Axillary node with calcifications	Axillary node containing calcifications	
111253	Axillary node hyperplasia	Excessive proliferation of normal tissue arrangement of the axillary node	
111254	<i>Asynchronous involution</i>		<i>Retired. Replaced with (F-8A063, SNM3, "Asynchronous involution of breast").</i>
111255	Benign cyst with blood	Cyst with benign morphology containing blood	
111256	Benign Calcifications	Calcifications having typically benign morphology. They are not of intermediate or high	

		probability of concern for malignancy.	
111257	<i>Intracystic papilloma</i>	<i>Growing within a cystic adenoma, filling the cavity with a mass of branching epithelial processes</i>	<i>Retired. Replaced with (M-85040, SNM3, "Intracystic papilloma").</i>
111258	Ductal adenoma	Adenoma located in mammary duct, present as discrete sclerotic nodules, solitary or multiple	
111259	Diabetic fibrous mastopathy	The occurrence of fibrous tumor-forming stromal proliferation in patients with diabetes mellitus	
111260	<i>Extra abdominal desmoid</i>	<i>A deep seated firm tumor frequently occurring on the chest consisting of collagenous tissue that infiltrates surround muscle; frequently recurs but does not metastasize</i>	<i>Retired. Replaced with (M-88211, SNM3, "Extra abdominal desmoid").</i>
111262	<i>Epidermal inclusion cyst</i>	<i>A cyst formed of a mass of epithelial cells, as a result of trauma has been pushed beneath the epidermis. The cyst is lined with squamous epithelium and contains concentric layers or keratin</i>	<i>Retired. Replaced with (M-33410, SNM3, "Epidermal inclusion cyst").</i>
111263	Fibroadenomatoid hyperplasia	Excessive proliferation of fibroadenoma tissue	
111264	Fibroadenolipoma	A lipoma with an abundant stroma of fibrous tissue	
111265	<i>Foreign body (reaction)</i>		<i>Retired. Replaced with (M-44140, SNM3, "Foreign body (reaction)").</i>
111269	<i>Galactocele</i>	<i>Retention cyst caused by occlusion of a lactiferous duct</i>	<i>Retired. Replaced with (D7-90364, SNM3, "Galactocele").</i>
111271	<i>Hemangioma – nonparenchymal, subcutaneous</i>	<i>A congenital anomaly that leads to a proliferation of blood vessels leading to a mass that resembles a neoplasm, not located in parenchymal areas but subcutaneous</i>	<i>Retired. Replaced with (D3-F0620, SNM3, "Hemangioma of subcutaneous tissue").</i>
111273	<i>Hyperplasia, usual</i>		<i>Retired. Replaced with (M-72000, SNM3, "Hyperplasia, usual").</i>
111277	Juvenile papillomatosis	A form of fibrocystic disease in young woman with florid and sclerosing adenosis that microscopically may suggest carcinoma	
111278	<i>Lactating adenoma</i>	<i>Enlarging masses during lactation. A circumscribed</i>	<i>Retired. Replaced with (M-82040, SNM3,</i>

		<i>benign tumor composed primarily of glandular structures with scanty stroma, with prominent secretory changes in the duct</i>	<i>"Lactating adenoma").</i>
111279	Lactational change	Changes related to the process of lactation	
111281	Large duct papilloma	A papilloma pertaining to large mammary duct	
111283	<i>Myofibroblastoma</i>	<i>Solitary or multiple tumors of muscles and fibrous tissues, or tumors composed of myofibroblasts</i>	<i>Retired. Replaced with (M-88250, SNM3, "Myofibroblastoma").</i>
111284	Microglandular adenosis	Irregular clusters of small tubules are present in adipose or fibrous tissue, resembling tubular carcinoma but lacking stromal fibroblastic proliferation	
111285	Multiple Intraductal Papillomas	Papilloma typically involving an aggregate of adjacent ducts in the periphery of the breast, likely representing involvement of several foci of one or two duct systems	
111286	No abnormality	No abnormality	
111287	Normal breast tissue	Normal breast tissue	
111288	<i>Neurofibromatosis</i>	<i>Condition in which there are tumors of various sizes on peripheral nerves. They may be neuromas or fibromas</i>	<i>Retired. Replaced with (M-95401, SNM3, "Neurofibromatosis").</i>
111290	Oil cyst (fat necrosis cyst)	A cyst resulting from the loss of the epithelial lining of a sebaceous dermoid or lacteal cyst	
111291	Post reduction mammoplasty	Breast tissue with characteristics of a benign nature, following breast reduction surgery	
111292	Pseudoangiomatous stromal hyperplasia	A benign stromal lesion composed of intermixed stromal and epithelial elements. The lobular and duct structures of the breast parenchyma are separated by an increased amount of stroma, non specific proliferative epithelial changes include hyperplasia of duct and lobular epithelium often with accentuation of myoepithelial cells and apocrine metaplasia with or without cyst formation	
111293	<i>Radial scar</i>	<i>An nonencapsulated stellate lesion consisting of a fibroelastic</i>	<i>Retired. Replaced with (M-78731, SNM3, "Radial</i>

		<i>core and radiating bands of fibrous connective tissue containing lobules manifesting adenosis and ducts with papillary or diffuse intraductal hyperplasia</i>	scar").
111294	<i>Sclerosing adenosis</i>	<i>Prominent interductal fibrosis of the terminal ductules</i>	<i>Retired. Replaced with (M-74220, SNM3, "Sclerosing adenosis").</i>
111296	Silicone granuloma	Nodular inflammatory lesions due to the presence of silicone in the breast tissue	
111297	Nipple Characteristic	The morphologic status of the nipple	
111298	Virginal hyperplasia	Spontaneous excessive proliferation of breast tissue, usually found in younger women	
111299	Peripheral duct papillomas	Papilloma(s) pertaining the peripheral ducts	
111300	Axillary node with lymphoma	Axillary node with lymphoid tissue neoplasm	
111301	Axillary nodal metastases	Metastatic disease to the axillary node	
111302	<i>Angiosarcoma</i>	<i>A malignant neoplasm occurring most often in breast and skin, believed to originate from endothelial cells of blood vessels, microscopically composed of closely packed round or spindle shaped cells, some of which line small spaces resembling vascular clefts</i>	<i>Retired. Replaced with (M-91203, SNM3, "Angiosarcoma").</i>
111303	Blood vessel (vascular) invasion	Histological changes to the vascular system related to an invasive process	
111304	Carcinoma in children	Carcinoma of the breast found in patients less than 20 years of age	
111305	Carcinoma in ectopic breast	A carcinoma found in supernumerary breasts and aberrant breast tissue	
111306	Carcinoma with endocrine differentiation	A carcinoma that synthesizes substances, including hormones, not considered to be normal products of the breast	
111307	Basal cell carcinoma of nipple	A basal cell carcinoma that arises in the nipple of the breast	
111308	<i>Carcinoma with metaplasia</i>		<i>Retired. Replaced with (M-85733, SNM3, "Carcinoma with metaplasia").</i>

111309	Cartilaginous and osseous change	Tissue changes to bones and cartilage	
111310	Carcinoma in pregnancy and lactation	Carcinoma of the breast presenting during pregnancy or lactation	
111311	<i>Carcinosarcoma</i>	<i>A malignant neoplasm that contains elements of carcinoma and sarcoma, so extensively intermixed as to indicate neoplasia of epithelial and mesenchymal tissue</i>	<i>Retired. Replaced with (M-89803, SNM3, "Carcinosarcoma").</i>
111312	Intraductal comedocarcinoma with necrosis	Comedocarcinoma of a duct with areas of necrotic tissue	
111313	Intraductal carcinoma, low grade	A non-invasive carcinoma restricted to the glandular lumen characterized by less aggressive malignant cytologic features and behavior	
111314	<i>Intraductal carcinoma micro-papillary</i>		<i>Retired. Replaced with (M-85072, SNM3, "Intraductal carcinoma micro-papillary").</i>
111315	Intracystic papillary carcinoma	A malignant neoplasm characterized by the formation of numerous, irregular, finger-like projections of fibrous stroma that is covered with a surface layer of neoplastic epithelial cells found in a cyst	
111316	Invasive and in-situ carcinoma	Carcinoma with both characteristics of localized and spreading disease	
111317	<i>Invasive lobular carcinoma</i>		<i>Retired. Replaced with (M-85203, SNM3, "Invasive lobular carcinoma").</i>
111318	Leukemic infiltration	Mammary infiltrates as a secondary manifestation in patients with established leukemia	
111320	Lymphatic vessel invasion	Histological changes to the lymphatic system related to an invasive process	
111321	<i>Lymphoma</i>	<i>A heterogenous group of neoplasms arising in the reticuloendothelial and lymphatic systems</i>	<i>Retired. Replaced with (M-95903, SNM3, "Lymphoma").</i>
111322	Occult carcinoma presenting with axillary lymph node metastases	A small carcinoma, either asymptomatic or giving rise to metastases without symptoms due to the primary carcinoma	

		presenting with metastatic disease in the axillary lymph nodes	
111323	Metastatic cancer to the breast	A malignant lesion in the breast with morphologic patterns not typical of breast carcinoma arising from a non-mammary malignant neoplasm	
111324	Metastatic cancer to the breast from the colon	A malignant lesion in the breast with morphologic patterns not typical of breast carcinoma arising from a neoplasm in the colon	
111325	Metastatic cancer to the breast from the lung	A malignant lesion in the breast with morphologic patterns not typical of breast carcinoma arising from a neoplasm in the lung	
111326	Metastatic melanoma to the breast	A malignant lesion in the breast with morphologic patterns not typical of breast carcinoma arising from a melanoma	
111327	Metastatic cancer to the breast from the ovary	A malignant lesion in the breast with morphologic patterns not typical of breast carcinoma arising from a neoplasm in the ovary	
111328	Metastatic sarcoma to the breast	A malignant lesion in the breast with morphologic patterns not typical of breast carcinoma arising from a sarcoma	
111329	Multifocal intraductal carcinoma	Multiple foci of non-invasive carcinoma restricted to the glandular lumen	
111330	Metastatic disease to axillary node	A malignant lesion in an axillary node arising from a non-axillary neoplasm	
111331	<i>Malignant fibrous histiocyoma</i>		<i>Retired. Replaced with (M-88303, SNM3, "Malignant fibrous histiocyoma").</i>
111332	Multifocal invasive ductal carcinoma	Multiple sites of ductal carcinoma	
111333	Metastasis to an intramammary lymph node	A malignant lesion in a intramammary lymph node arising from a non-intramammary lymph node neoplasm	
111334	Malignant melanoma of nipple	A malignant melanoma of the skin that arises in the nipple of the breast	

111335	<i>Neoplasm of the mammary skin</i>		<i>Retired. Replaced with (D0-F035F, SNM3, "Neoplasm of the mammary skin").</i>
111336	<i>Papillary carcinoma in-situ</i>		<i>Retired. Replaced with (M-80502, SNM3, "Papillary carcinoma in-situ").</i>
111338	Recurrent malignancy	Recurrent malignancy	
111340	Squamous cell carcinoma of the nipple	Squamous cell carcinoma to the terminal portion of the alveolar	
111341	Intraductal carcinoma, high grade	A non-invasive carcinoma restricted to the glandular lumen characterized by more aggressive malignant cytologic features and behavior	
111342	<i>Invasive cribriform carcinoma</i>		<i>Retired. Replaced with (M-82013, SNM3, "Invasive cribriform carcinoma").</i>
111343	Angular margins	An indication that some or all of the margin of a lesion has sharp corners, often forming acute angles.	
111344	Fine pleomorphic calcification	Calcifications that vary in sizes and shapes and are usually smaller than 0.5 mm in diameter.	
111345	Macrocalcifications	Coarse calcifications that are 0.5 mm or greater in size.	
111346	Calcifications within a mass	An indicator that calcifications are imbedded within a mass	
111347	Calcifications outside of a mass	An indicator that calcifications are imaged outside of a mass finding	
111350	Breast background echotexture	Tissue composition of the breast noted on sonography.	
111351	Homogeneous fat echotexture	Fat lobules and uniformly echogenic bands of supporting structures comprise the bulk of breast tissue.	
111352	Homogeneous fibroglandular echotexture	A uniformly echogenic layer of fibroglandular tissue is seen beneath a thin layer of subcutaneous fat.	
111353	Heterogeneous echotexture	The breast texture is characterized by multiple small	

		areas of increased and decreased echogenicity.	
111354	Orientation	Referential relationship of the finding to the imaging device as noted on sonography.	
111355	Parallel	The long axis of a lesion parallels the skin line ("wider-than-tall" or in a horizontal orientation).	
111356	Not parallel	The anterior-posterior or vertical dimension is greater than the transverse or horizontal dimension.	
111357	Lesion boundary	The lesion boundary describes the transition zone between the mass and the surrounding tissue.	
111358	Abrupt interface	The sharp demarcation between the lesion and surrounding tissue can be imperceptible or a distinct well-defined echogenic rim of any thickness.	
111359	Echogenic halo	There is no sharp demarcation between the mass and the surrounding tissue which is bridged by an echogenic transition zone.	
111360	Echo pattern	An imaging characteristic of resonance noted during sonography	
111361	Anechoic	Without internal echoes	
111362	Hyperechoic	Having increased echogenicity relative to fat or equal to fibroglandular tissue	
111363	Complex	Mass contains both anechoic and echogenic components	
111364	Hypoechoic	Defined relative to fat; masses are characterized by low-level echoes throughout (e.g. appearance of a complicated cyst or fibroadenoma)	
111365	Isoechoic	Having the same echogenicity as fat (a complicated cyst or fibroadenoma may be isoechoic or hypoechoic)	



111366	Posterior acoustic features	The attenuation characteristics of a mass with respect to its acoustic transmission.	
111367	No posterior acoustic features	No posterior shadowing or enhancement	
111368	Posterior enhancement	Increased posterior echoes	
111369	Posterior shadowing	Decreased posterior echoes; edge shadows are excluded	
111370	Combined posterior enhancement and shadowing	More than one pattern of posterior attenuation, both shadowing and enhancement	
111371	Identifiable effect on surrounding tissues	Sonographic appearance of adjacent structures relative to a mass finding	
111372	Vascularity	Characterization of vascularization in region of interest.	
111373	Vascularity not present	Vascularity not evident, such as on ultrasound	
111374	Vascularity not assessed	Vascularity not evaluated	
111375	Vascularity present in lesion	Vascularity on imaging is seen within a lesion	
111376	Vascularity present immediately adjacent to lesion	Vascularity on imaging is seen immediately adjacent to a lesion	
111377	Diffusely increased vascularity in surrounding tissue	Vascularity on imaging is considered diffusely elevated within the surrounding breast tissue	
111380	Correlation to other Findings	Relationship of the new anomaly to other clinical or imaging anomalies	
111381	Correlates to physical exam findings	An indication that the current imaging finding relates to a finding from a clinical breast exam	
111382	Correlates to mammography findings	An indication that the current imaging finding relates to a finding from a mammography exam	
111383	Correlates to MRI findings	An indication that the current imaging finding relates to a	

	findings	finding from a breast MRI exam	
111384	Correlates to ultrasound findings	An indication that the current imaging finding relates to a finding from a breast ultrasound exam	
111385	Correlates to other imaging findings	An indication that the current imaging finding relates to a finding from an imaging exam	
111386	No correlation to other imaging findings	An indication that the current imaging finding has no relation to findings from any other imaging exam	
111387	No correlation to clinical findings	An indication that the current imaging finding has no relation to any other clinical findings	
111388	Malignancy Type	Classification of the cancer as invasive, DCIS, or other	
111389	Invasive breast carcinoma	A malignancy that has spread beyond an area of focus.	
111390	Other malignancy type	A breast cancer with malignant pathology findings that are not classified as invasive or in situ.	
111391	Menstrual Cycle Phase	A specific timeframe during menses	
111392	1st week	In the first week of the menstrual cycle phase, that is, one week following menses.	
111393	2nd week	In the second week of the menstrual cycle phase, that is, two weeks following menses.	
111394	3rd week	In the third week of the menstrual cycle phase, that is, three weeks following menses.	
111395	Estimated Timeframe	An estimated period of time	
111396	< 3 months ago	An event occurred less than 3 months ago.	
111397	4 months to 1 year ago	An event occurred between 4 months and 1 year ago.	
111398	> 1 year ago	An event occurred longer than 1 year ago.	
111399	Timeframe uncertain	The timing of an event is not	

		recalled.	
111400	Breast Imaging Report	Report title for the diagnostic report for one or more breast imaging or intervention procedures.	
111401	Reason for procedure	Concept name for the description of why a procedure has been performed.	
111402	Clinical Finding	A finding during clinical examination (i.e., history and physical examination) such as pain, palpable mass or discharge.	
111403	Baseline screening mammogram	First screening mammogram taken for patient that is used as a comparison baseline for further examinations.	
111404	First mammogram ever	First mammogram taken for a patient without regard to whether it was for screening or a diagnostic procedure.	
111405	Implant type	Concept name for the material of which a breast prosthetic device is constructed.	
111406	Number of similar findings	A numeric count of findings classified as similar in nature.	
111407	Implant finding	Concept name for the status of a breast prosthetic device as noted by imaging.	
111408	Film Screen Mammography	Mammogram using traditional x-ray film.	
111409	Digital Mammography	Mammogram using a digital image acquisition system.	
111410	Surgical consult	Referred for evaluation by a surgeon.	
111411	Mammography CAD	Computer aided detection and/or computer aided diagnosis for mammography.	
111412	Narrative Summary	Concept name for a text-based section of a report.	
111413	Overall Assessment	A title for a report section that summarizes all interpretation results for a report with one overriding assessment (e.g., benign or negative).	
111414	Supplementary Data	Concept name for a collection of supporting evidence for a report.	
111415	Additional evaluation requested from prior study	Prior study indicates that additional imaging be performed to further evaluate a suspicious	

		or questionable anatomic region.	
111416	Follow-up at short interval from prior study	The prior study recommended a follow-up breast imaging exam in 1 to 11 months (generally in 6 months).	
111417	History of breast augmentation, asymptomatic	Prior breast augmentation (breast enlargement) and is not presenting with any symptoms.	
111418	Review of an outside study	Review or second opinion made on an image performed outside of the facility.	
111419	Additional evaluation requested from abnormal screening exam	Additional breast imaging performed at the time of the patient's screening mammogram.	
111420	History of benign breast biopsy	Patient has had previous benign breast biopsies.	
111421	Personal history of breast cancer with breast conservation therapy	Patient has had a prior surgery such as a lumpectomy or quadrantectomy to remove malignant breast tissue, but breast tissue remains.	
111423	Physical Examination Results	The results of a physical examination performed on the patient, possibly including the results of inspection, palpation, auscultation, or percussion.	
111424	Comparison to previous findings	The result of assessing the current imaging exam in comparison to previous imaging exams.	
111425	Intraluminal filling defect	An abnormality observed during ductography where the ductal system within the breast fills in an abnormal pattern. Ductography is an imaging exam in which a radio opaque contrast media is introduced into the ductal system of the breast through the nipple and images of the ductal system are obtained.	
111426	Multiple filling defect	During ductography an observation of more than one filling abnormality within the breast ductal system.	
111427	Abrupt duct termination	An abnormality observed during ductography where the ductal system within the breast terminates in an unusual fashion.	
111428	Extravasation	Abnormal flowage of contrast media within the breast noted on	

		ductography.	
111429	Duct narrowing	An abnormality observed during ductography where the ductal system within the breast appears narrow.	
111430	Cyst fill	During ductography an observation of the contrast media filling a cyst within the breast.	
111431	Instrument Approach	The area and line within the anatomy through which a needle or instrument passes during an interventional procedure.	
111432	Inferolateral to superomedial	The line within the anatomy from the lower outer to the upper inner aspect, for example, through which a needle or instrument passes in an interventional procedure.	
111433	Inferomedial to superolateral	The line within the anatomy from the lower inner to the upper outer aspect, for example, through which a needle or instrument passes in an interventional procedure.	
111434	Superolateral to inferomedial	The line within the anatomy from the upper outer to the lower inner aspect, for example, through which a needle or instrument passes in an interventional procedure.	
111435	Superomedial to inferolateral	The line within the anatomy from the upper inner to the lower outer aspect, for example, through which a needle or instrument passes in an interventional procedure.	
111436	Number of passes	The number of times a biopsy instrument is passed through an area of interest.	
111437	Number of specimens	The number of biopsy specimens obtained from an interventional procedure.	
111438	Needle in target	An indicator of whether or not a biopsy or localizing needle in an interventional procedure is seen to be in the area of interest.	
111439	Number of needles around target	The number of localizing needles placed around the area of interest in an interventional procedure.	
111440	Incision made	An indicator of whether or not an	

		incision was made in the anatomy during an interventional procedure.	
111441	Microclip placed	An indicator of whether or not a radio opaque microclip was placed in the anatomy during an interventional procedure.	
111442	Confirmation of target	An indicator of the degree of success of an interventional procedure.	
111443	Target completely contained in the specimen	An indicator that during an interventional procedure the area of interest was fully excised and is noted in the resultant biopsy specimen.	
111444	Target partially obtained in the specimen	An indicator that during an interventional procedure the area of interest was partially excised and is noted in the resultant biopsy specimen.	
111445	Target not in the specimen	An indicator that following an interventional procedure the area of interest is not seen in the resultant biopsy specimen.	
111446	Calcifications seen in the core	An indicator that following an interventional procedure the targeted calcifications are noted in the resultant biopsy specimen.	
111447	Lesion completely removed	An indicator that during an interventional procedure the area of interest was fully excised and is noted in the resultant biopsy specimen.	
111448	Lesion partially removed	An indicator that during an interventional procedure the area of interest was partially excised and is noted in the resultant biopsy specimen.	
111449	Fluid obtained	An indicator that during an interventional procedure fluid was successfully aspirated.	
111450	Light brown color	Color that is a light shade of brown.	
111451	Dark red color	Color that is a dark shade of red.	
111452	Dark brown color	Color that is a dark shade of brown.	
111453	Bright red color	Color that is a bright shade of red.	
111454	Blood tinged color	Color that is tinged with the color of blood.	
111455	Occult blood test	An indicator of whether or not	

	result	the fluid obtained during an interventional procedure contains red blood cells.	
111456	Action on fluid	An indicator of whether or not fluid during an interventional procedure was sent for cytological analysis or simply discarded.	
111457	Sent for analysis	An indicator that fluid obtained during an interventional procedure was sent to a laboratory for analysis.	
111458	Discarded	An indicator that fluid obtained during an interventional procedure was discarded.	
111459	Mass with calcifications	A radiopaque density noted during diagnostic imaging which has associated calcific densities.	
111460	Complex cyst	A fluid-filled sac with greater than normal characteristics.	
111461	Intracystic lesion	A tumor within a cyst.	
111462	Solid mass	A tumor or lesion.	
111463	Supplementary Data for Intervention	Supporting evidence for interpretation results of an interventional procedure.	
111464	Procedure Modifier	A descriptor that further qualifies or characterizes a type of procedure.	
111465	Needle Gauge	Needle size (diameter) characterization, for example, of a biopsy needle.	
111466	Severity of Complication	An indicator of the gravity of a problem experienced by a patient, related to a procedure that was performed.	
111467	Needle Length	Distance from the hub or bushing to the tip of the needle.	
111468	Pathology Results	The collection of observations and findings from pathologic analysis.	
111469	Sampling Datetime	The date and time that the sample was collected from the patient.	
111470	Uninvolved	Indicates that the margin of the biopsy specimen was not involved with the tumor.	
111471	Involved	Indicates that the margin of the biopsy specimen was involved with the tumor.	
111472	Nipple involved	Indicates whether the nipple was	

		involved in an interventional procedure or pathologic analysis.	
111473	Number of nodes removed	Indicates the number of lymph nodes removed.	
111474	Number of nodes positive	Indicates the number of lymph nodes removed that contain cancer cells.	
111475	Estrogen receptor	The result of a test for the presence of a protein that binds with estrogen.	
111476	Progesterone receptor	The result of a test for the presence of a protein that binds with progesterone.	
111477	S Phase	Indicates the percentage of cells in S phase. Cell division is defined by phases; the S phase is the stage during which DNA replicates.	
111478	Non-bloody discharge (from nipple)	The visible emission of non-bloody fluid from the nipple.	
111479	Difficult physical/clinical examination	The inability to discern normal versus abnormal breast tissue during palpation.	
111480	Cancer elsewhere	An indication that a patient has or had a malignant occurrence in an area of the body other than the breast.	
111481	Saline implant	A salt water filled prosthetic device implanted in the breast.	
111482	Polyurethane implant	A polymer based (plastic) prosthetic device implanted in the breast.	
111483	Percutaneous silicone injection	The introduction of polymeric organic silicon based material through the skin, as for breast augmentation or reconstruction.	
111484	Combination implant	A prosthetic device that contains more than one material implanted in the breast.	
111485	Pre-pectoral implant	A breast implant placed in front of the pectoralis major muscle.	
111486	Retro-pectoral implant	A breast implant placed behind the pectoralis major muscle.	
111487	Mammographic (crosshair)	Using x-ray technique and a superimposed set of crossed lines for detection or placement.	
111488	Mammographic (grid)	Using x-ray technique and a superimposed aperture for	



		detection or placement.	
111489	Palpation guided	Using physical touch for detection or placement.	
111490	Vacuum assisted	The performance of a biopsy procedure using a vacuum device attached to the biopsy needle.	
111491	Abnormal discharge	Unusual or unexpected emission of fluid.	
111492	No complications	Having experienced no adverse medical conditions related to or resulting from an interventional procedure.	
111494	Stage 0	TNM grouping of tumor stage, from AJCC, where primary tumor is Tis, regional lymph node is N0, and distant metastasis is M0.	
111495	Stage I	TNM grouping of tumor stage, from AJCC, where primary tumor is T1, regional lymph node is N0, and distant metastasis is M0.	
111496	Stage IIA	TNM grouping of tumor stage, from AJCC, where primary tumor is T0 or T1, with regional lymph node N1 and distant metastasis is M0, or T2 with N0 and M0.	
111497	Stage IIB	TNM grouping of tumor stage, from AJCC, where primary tumor is T2, with regional lymph node N1 and distant metastasis is M0, or T3 with N0 and M0.	
111498	Stage IIIA	TNM grouping of tumor stage, from AJCC, where primary tumor is T0, T1 or T2, with regional lymph node N2 and distant metastasis is M0, or T3 with N1 or N2 and M0.	
111499	Stage IIIB	TNM grouping of tumor stage, from AJCC, where primary tumor is T4, regional lymph node is N0, N1 or N2, and distant metastasis is M0.	
111500	Stage IIIC	TNM grouping of tumor stage, from AJCC, where primary tumor is any T value, regional lymph node is N3, and distant metastasis is M0.	
111501	Stage IV	TNM grouping of tumor stage, from AJCC, where primary tumor is any T value, regional lymph node is any N value, and distant	

		metastasis is M1.	
111502	Bloom-Richardson Grade	Histologic tumor grade (sometimes called Scarff-Bloom-Richardson grade) is based on the arrangement of the cells in relation to each other -- whether they form tubules, how closely they resemble normal breast cells (nuclear grade) and how many of the cancer cells are in the process of dividing (mitotic count).	
111503	Normal implants	Breast prosthetic devices are intact, not leaking, and are in a normal shape and form.	
111504	Asymmetric implants	Breast prosthetic devices are not symmetric, equal, corresponding in form, or are in one breast (unilateral).	
111505	Calcified implant	Fibrous or calcific contracture of the tissue capsule that forms around a breast prosthetic device.	
111506	Distorted implant	Breast prosthetic device is twisted out of normal shape or form.	
111507	Silicone-laden lymph nodes	Silicone from breast prosthetic device found in lymphatic tissue.	
111508	Free silicone	Silicone found in breast tissue outside of the prosthetic capsule or implant membrane.	
111509	Herniated implant	Protrusion of part of the structure normally encapsulating the content of the breast prosthetic device.	
111510	Explantation	Evidence of removal of a breast prosthetic device.	
111511	Relevant Patient Information for Breast Imaging	Historical patient health information of interest to the breast health clinician.	
111512	<i>Medication History</i>	<i>Information regarding usage by the patient of certain medications, such as hormones.</i>	<i>Retired, Replaced with (10160-2, LN, "History Of Medication Use")</i>
111513	Relevant Previous Procedures	Interventional or non-interventional procedures previously performed on the patient, such as breast biopsies.	
111514	<i>Relevant Indicated Problems</i>	<i>Abnormal conditions experienced by the patient which serve as the reason for performing a procedure, such as</i>	<i>Retired, Replaced with (11450-4, LN, "Problem List")</i>

		<i>a breast exam.</i>	
111515	Relevant Risk Factors	Personal, familial, and other health factors that may indicate an increase in the patient's chances of developing a health condition or disease, such as breast cancer.	
111516	Medication Type	A classification of a medicinal substance, such as hormonal contraceptive or antibiotic.	
111517	Relevant Patient Information	Historical patient health information for general purpose use.	
111518	Age when first menstrual period occurred	The age of the patient at the first occurrence of menses.	
111519	Age at First Full Term Pregnancy	The age of the patient at the time of her first full term pregnancy.	
111520	Age at Menopause	The age of the patient at the cessation of menses.	
111521	Age when hysterectomy performed	The age of the patient at the time her uterus was removed.	
111522	Age when left ovary removed	The age of the patient at the time she had her left ovary removed.	
111523	Age when right ovary removed	The age of the patient at the time she had her right ovary removed.	
111524	Age Started	The age of a patient on the first occurrence of an event, such as the first use of a medication.	
111525	Age Ended	The age of a patient on the last occurrence of an event, such as the last use of a medication.	
111526	Datetime Started	The date and time of the first occurrence of an event, such as the first use of a medication.	
111527	Datetime Ended	The date and time of the last occurrence of an event, such as the last use of a medication.	
111528	Ongoing	An indicator of whether an event is still in progress, such as the use of a medication or substance, or environmental exposure.	
111529	Brand Name	Product name of a device or substance, such as medication, to identify it as the product of a single firm or manufacturer.	

111530	Risk Factor modifier	A descriptor that further qualifies or characterizes a risk factor.	
111531	Previous Procedure	A prior non-interventional exam or interventional procedure performed on a patient.	
111532	Pregnancy Status	Describes the pregnancy state of a referenced subject.	
111533	Indicated Problem	A symptom experienced by a patient that is used as the reason for performing an exam or procedure.	
111534	Role of person reporting	The function of the individual who is reporting information on a patient, which could be a specific health care related profession, the patient him/herself, or a relative or friend.	
111535	Datetime problem observed	The date and time that a symptom was noted.	
111536	Datetime of last evaluation	The date and time of the most recent evaluation of an indicated problem.	
111537	Family Member with Risk Factor	A patient's biological relative who exhibits a health factor that may indicate an increase in the patient's chances of developing a particular disease or medical problem.	
111538	Age at Occurrence	The age at which an individual experienced a specific event, such as breast cancer.	
111539	Menopausal phase	The current stage of an individual in her gynecological development.	
111540	Side of Family	An indicator of paternal or maternal relationship.	
111541	Maternal	Relating to biological female parentage.	
111542	Unspecified gynecological hormone	A gynecological hormone (e.g., contraceptive, estrogen, Tamoxifen) for which the specific type is not specified.	
111543	Breast feeding history	An indicator of whether or not a patient ever provided breast milk to her offspring.	
111544	Average breast feeding period	The average length of time that a patient provided breast milk to her offspring.	
111545	Substance Use History	Information regarding usage by the patient of certain legal or	

		illicit substances.	
111546	Used Substance Type	A classification of a substance, such as alcohol or a legal or illicit drug.	
111547	Environmental Exposure History	Information regarding exposure of the patient to potentially harmful environmental factors.	
111548	Environmental Factor	A classification of a potentially harmful substance or gas in a subject's environment, such as asbestos, lead, or carcinogens.	
111549	Previous Reports	Previous Structured Reports that could have relevant information for a current imaging service request.	
111550	Personal breast cancer history	An indication that a patient has had a previous malignancy of the breast.	
111551	History of endometrial cancer	Indicates a previous occurrence of cancer of the lining of the uterus.	
111552	History of ovarian cancer	Indicates a previous occurrence of cancer of the lining of the ovary.	
111553	History of high risk lesion on previous biopsy	Indicates a prior diagnosis of pre-cancerous cells or tissue removed for pathologic evaluation.	
111554	Post menopausal patient	A female patient whose menstrual periods have ceased.	
111555	Late child bearing (after 30)	A female patient whose first child was born after the patient was 30 years old.	
111556	BRCA1 breast cancer gene	The first level genetic marker indicating risk for breast cancer.	
111557	BRCA2 breast cancer gene	The second level genetic marker indicating risk for breast cancer.	
111558	BRCA3 breast cancer gene	The third level genetic marker indicating risk for breast cancer.	
111559	Weak family history of breast cancer	A patient's biological aunt, grandmother, or female cousin was diagnosed with breast cancer. Definition from BI-RADS®.	
111560	Intermediate family history of breast cancer	A patient's biological mother or sister was diagnosed with breast cancer after they had gone through menopause. Definition from BI-RADS®.	
111561	Very strong family	A patient's biological mother or	

	history of breast cancer	sister was diagnosed with breast cancer before they had gone through menopause, or more than one of the patient's first-degree relatives (biological mother or sister) were diagnosed with breast cancer after they had gone through menopause. Definition from BI-RADS®.	
111562	Family history of prostate cancer	Previous diagnosis of a malignancy of the prostate gland in a biological relative.	
111563	Family history unknown	The health record of a patient's biological relatives is not known.	
111564	Nipple discharge cytology	The study of cells obtained from fluid emitted from the breast.	
111565	Uterine malformations	A developmental abnormality resulting in an abnormal shape of the uterus.	
111566	Spontaneous Abortion	A naturally occurring premature expulsion from the uterus of the products of conception – the embryo or a nonviable fetus.	
111567	Gynecologic condition	An ailment/abnormality or state of the female reproductive tract.	
111568	Gynecologic surgery	A surgical operation performed on any portion of the female reproductive tract.	
111569	Previous LBW or IUGR birth	Prior pregnancy with a low birth weight baby or a fetus with Intrauterine Growth Restriction or Retardation.	
111570	Previous fetal malformation/syndrome	History of at least one prior pregnancy with fetal anatomic abnormality(s).	
111571	Previous RH negative or blood dyscrasia at birth	History of delivering a Rhesis Isoimmunization affected child(ren) or a child(ren) with another blood disorder.	
111572	History of multiple fetuses	History of at least one pregnancy that contained more than one fetus (e.g., twins, triplets, etc.)	
111573	Current pregnancy, known or suspected malformations/syndromes	At least one fetus of this pregnancy has an anatomic abnormality(s) that is known to exist, or a "marker" is present that suggests the abnormality(s) may be present.	
111574	Family history, fetal malformation/syndrome	Biological relatives have previously conceived a fetus with an anatomic abnormality(s).	

111575	High	A subjective descriptor for an elevated amount of exposure, use, or dosage, incurring high risk of adverse effects.	
111576	Medium	A subjective descriptor for a moderate amount of exposure, use, or dosage, incurring medium risk of adverse effects.	
111577	Low	A subjective descriptor for a limited amount of exposure, use, or dosage, incurring low risk of adverse effects.	
111578	Dose frequency	A measurement of the rate of occurrence of which a patient takes a certain medication.	
111579	Rate of exposure	The quantity per unit of time that a patient was or is being exposed to an environmental irritant.	
111580	Volume of use	The quantity per unit of time that a medication or substance was or is being used.	
111581	Relative dose amount	A qualitative descriptor for the amount of a medication that was or is being taken.	
111582	Relative amount of exposure	A qualitative descriptor for the amount of present or past exposure to an environmental irritant.	
111583	Relative amount of use	A qualitative descriptor for the amount of a medication or substance that was or is being used.	
111584	Relative dose frequency	A qualitative descriptor for the frequency with which a medication was or is being taken.	
111585	Relative frequency of exposure	A qualitative descriptor for the frequency of present or past exposure to an environmental irritant.	
111586	Relative frequency of use	A qualitative descriptor for the frequency with which a medication or substance was or is being used.	
111601	Green filter	Filter that transmits one third of white light (green) while blocking the other two thirds	
111602	Red filter	Filter that transmits one third of white light (red) while blocking the other two thirds	

111603	Blue filter	Filter that transmits one third of white light (blue) while blocking the other two thirds	
111604	Yellow-green filter	A filter of 560nm that is used for retinal imaging and can provide good contrast and good visibility of the retinal vasculature	
111605	Blue-green filter	A filter of 490nm that is used for retinal imaging because of excessive scattering of some retinal structures at very short wavelengths	
111606	Infrared filter	Filter that transmits the infrared spectrum, which is light that lies outside of the visible spectrum, with wavelengths longer than those of red light, while blocking visible light	
111607	Polarizing filter	A filter that reduces reflections from non-metallic surfaces such as glass or water by blocking light waves that are vibrating at selected angles to the filter.	
111609	No filter	No filter used	
111621	Field 1 for Joslin 3 field	Joslin NM-1 is a 45 degree field focused centrally between the temporal margin of optic disc and the center of the macula: Center the camera on the papillomacular bundle midway between the temporal margin of the optic disc and the center of the macula. The horizontal centerline of the image should pass directly through the center of the disc	
111622	Field 2 for Joslin 3 field	Joslin NM-2 is a 45 degree field focused superior temporal to the optic disc: Center the camera laterally approximately one-half disc diameter temporal to the center of the macula. The lower edge of the field is tangent to a horizontal line passing through the upper edge of the optic disc. The image is taken temporal to the macula but includes more retinal nasal and superior to the macula than standard field 2.	
111623	Field 3 for Joslin 3 field	Joslin NM-3 is a 45 degree field focused nasal to the optic disc: This field is nasal to the optic disc and may include part of the optic disc. The horizontal	



		centerline of the image should pass tangent to the lower edge of the optic disc.	
112000	Chest CAD Report	A structured report containing the results of computer-aided detection or diagnosis applied to chest imaging and associated clinical information.	
112001	Opacity	The shadow of an absorber that attenuates the X-ray beam more effectively than do surrounding absorbers. In a radiograph, any circumscribed area that appears more nearly white (of lesser photometric density) than its surround [Fraser and Pare].	
112002	Series Instance UID	A unique identifier for a series of DICOM SOP instances.	
112003	Associated Chest Component	A named anatomic region within the chest cavity.	
112004	Abnormal interstitial pattern	A collection of opacities detected within the continuum of loose connective tissue throughout the lung, that is not expected in a diagnostically normal radiograph.	
112005	Radiographic anatomy	A type of anatomy that is expected to be detectable on a radiographic (X-ray based) image.	
112006	Distribution Descriptor	Characteristic of the extent of spreading of a finding or feature.	
112007	Border definition	Characteristic of the clarity of the boundary or edges of a finding or feature.	
112008	Site involvement	The part(s) of the anatomy affected or encompassed by a finding or feature.	
112009	Type of Content	Characteristic of the matter or substance within a finding or feature.	
112010	Texture Descriptor	Characteristic of the surface or consistency of a finding or feature.	
112011	Positioner Primary Angle	Position of the X-ray beam about the patient from the RAO to LAO direction where movement from RAO to vertical is positive.	
112012	Positioner Secondary Angle	Position of the X-ray beam about the patient from the caudal to cranial direction where movement from caudal to	

		vertical is positive.	
112013	Location in Chest	The zone, lobe or segment within the chest cavity in which a finding or feature is situated.	
112014	Orientation Descriptor	Vertical refers to orientation parallel to the superior-inferior (cephalad-caudad) axis of the body, with horizontal being perpendicular to this, and an oblique orientation having projections in both the horizontal and vertical.	
112015	Border shape	Characteristic of the shape formed by the boundary or edges of a finding or feature.	
112015	Border shape	Characteristic of the shape formed by the boundary or edges of a finding or feature.	
112016	Baseline Category	Indicates whether a finding was considered a target lesion, non-target lesion, or non-lesion during evaluation of a baseline series, according to a method such as RECIST.	
112016	Baseline Category	Indicates whether a finding was considered a target lesion, non-target lesion, or non-lesion during evaluation of a baseline series, according to a method such as RECIST.	
112017	Cavity extent as percent of volume	The extent of a detected cavity, represented as the percent of the surrounding volume that it occupies.	
112017	Cavity extent as percent of volume	The extent of a detected cavity, represented as the percent of the surrounding volume that it occupies.	
112018	Calcification extent as percent of surface	The extent of a detected calcification, represented as the percent of the surrounding surface that it occupies.	
112018	Calcification extent as percent of surface	The extent of a detected calcification, represented as the percent of the surrounding surface that it occupies.	
112019	Calcification extent as percent of volume	The extent of a detected calcification, represented as the percent of the surrounding volume that it occupies.	
112019	Calcification extent as percent of volume	The extent of a detected calcification, represented as the	

		percent of the surrounding volume that it occupies.	
112020	Response Evaluation	A heading for the reporting of response evaluation for treatment of solid tumors.	
112021	Response Evaluation Method	The system applied in the reporting of response evaluation for treatment of solid tumors.	
112022	RECIST	Response Evaluation Criteria In Solid Tumors. See Normative References.	
112023	Composite Feature Modifier	A term which further specifies the name of an item that is an inferred correlation relating two or more individual findings or features.	
112024	Single Image Finding Modifier	A term which further specifies the name of an item that was detected on one image.	
112025	Size Descriptor	A qualitative descriptor for the extent of a finding or feature.	
112026	Width Descriptor	A qualitative descriptor for the thickness of tubular structures, such as blood vessels.	
112027	Opacity Descriptor	A characteristic that further describes the nature of an opacity.	
112028	Abnormal Distribution of Anatomic Structure	The type of adverse affect that a finding or feature is having on the surrounding anatomy.	
112029	WHO	Response evaluation method as defined in chapter 5, "Reporting of Response" of the WHO Handbook for Reporting Results for Cancer Treatment. See Normative References.	
112030	Calcification Descriptor	Identification of the morphology of detected calcifications.	
112031	Attenuation Coefficient	A quantitative numerical statement of the relative attenuation of the X-ray beam at a specified point; for example, expressed in Hounsfield units [referred to as CT Number in Fraser and Pare].	
112032	Threshold Attenuation Coefficient	An X-ray attenuation coefficient that is used as a threshold, for example, in calcium scoring.	
112033	Abnormal opacity	An opacity that is not expected in a diagnostically normal radiograph.	

112034	Calculation Description	A textual description of the mathematical method of calculation which resulted in a calculated value.	
112035	Performance of Pediatric and Adult Chest Radiography, ACR	American College of Radiology. ACR Standard for the Performance of Pediatric and Adult Chest Radiography. In: Standards. Reston, Va: 2001:95-98.	
112036	ACR Position Statement	American College of Radiology. ACR Position Statement. In: Standards. Reston, Va: 2001:iv.	
112037	Non-lesion Modifier	A descriptor for a non-lesion object finding or feature, used to indicate whether the object was detected as being internal or external to the patient's body.	
112038	Osseous Modifier	A concept modifier for an Osseous Anatomy, or bone related, finding.	
112039	Tracking Identifier	A text label used for tracking a finding or feature, potentially across multiple reporting objects, over time. This label shall be unique within the domain in which it is used.	
112040	Tracking Unique Identifier	A unique identifier used for tracking a finding or feature, potentially across multiple reporting objects, over time.	
112041	Target Lesion Complete Response	Disappearance of all target lesions.	
112042	Target Lesion Partial Response	At least a 30% decrease in the sum of the Longest Diameter of target lesions, taking as reference the baseline sum Longest Diameter.	
112043	Target Lesion Progressive Disease	At least a 20% increase in the sum of the Longest Diameter of target lesions, taking as reference the smallest sum Longest Diameter recorded since the treatment started, or the appearance of one or more new lesions.	
112044	Target Lesion Stable Disease	Neither sufficient shrinkage to qualify for Partial Response nor sufficient increase to qualify for Progressive Disease, taking as reference the smallest sum Longest Diameter since the treatment started.	

112045	Non-Target Lesion Complete Response	Disappearance of all non-target lesions and normalization of tumor marker level.	
112046	Non-Target Lesion Incomplete Response or Stable Disease	Persistence of one or more non-target lesions and/or maintenance of tumor marker level above the normal limits.	
112047	Non-Target Lesion Progressive Disease	Appearance of one or more new lesions and/or unequivocal progression of existing non-target lesions.	
112048	Current Response	The current response evaluation for treatment of solid tumors, according to a method such as RECIST.	
112049	Best Overall Response	Best response recorded from the start of the treatment until disease progression/recurrence, taking as reference for Progressive Disease the smallest measurements recorded since the treatment started, according to a method such as RECIST.	
112050	Anatomic Identifier	A text identifier of an anatomic feature when a multiplicity of features of that type may be present, such as "Rib 1", "Rib 2" or thoracic vertebrae "T1" or "T2".	
112051	Measurement of Response	A measured or calculated evaluation of response. For example, according to a method such as RECIST, the value would be the calculated sum of the lengths of the longest axes of a set of target lesions.	
112052	Bronchovascular	Of or relating to a bronchial (lung) specific channel for the conveyance of a body fluid.	
112053	Osseous	Of, relating to, or composed of bone.	
112054	Secondary pulmonary lobule	The smallest unit of lung surrounded by connective tissue septa; the unit of lung subtended by any bronchiole that gives off three to five terminal bronchioles [Fraser and Pare].	
112055	Agatston scoring method	A method of calculating an overall calcium score, reflecting the calcification of coronary arteries, based on the maximum X-ray attenuation coefficient and the area of calcium deposits.	

112056	Volume scoring method	A method of calculating an overall calcium score, reflecting the calcification of coronary arteries, based on the volume of each calcification, typically expressed in mm <sup>3</sup> .	
112057	Mass scoring method	A method of calculating an overall calcium score, reflecting the calcification of coronary arteries, based on the total mass of calcification, typically expressed in mg.	
112058	Calcium score	A measure often arrived at through calculation of findings from CT examination, which is a common predictor of significant stenosis of the coronary arteries.	
112059	Primary complex	The combination of a focus of pneumonia due to a primary infection with granulomas in the draining hilar or mediastinal lymph nodes [Fraser and Pare].	
112060	Oligemia	General or local decrease in the apparent width of visible pulmonary vessels, suggesting less than normal blood flow (reduced blood flow) [Fraser and Pare].	
112061	Abnormal lines (1D)	Linear opacity of very fine width, i.e. a nearly one dimensional opacity.	
112062	Abnormal lucency	Area of abnormal very low X-ray attenuation, typically lower than aerated lung when occurring in or projecting over lung, or lower than soft tissue when occurring in or projecting over soft tissue.	
112063	Abnormal calcifications	A calcific opacity within the lung that may be organized, but does not display the trabecular organization of true bone [Fraser and Pare].	
112064	Abnormal texture	Relatively homogeneous, extended, pattern of abnormal opacity in the lung, typically low in contrast.	
112065	Reticulonodular pattern	A collection of innumerable small, linear, and nodular opacities that together produce a composite appearance resembling a net with small superimposed nodules. The reticular and nodular elements	

		are dimensionally of similar magnitude [Fraser and Pare].	
112066	Beaded septum sign	Irregular septal thickening that suggests the appearance of a row of beads; usually a sign of lymphangitic carcinomatosis, but may also occur rarely in sarcoidosis [Fraser and Pare].	
112067	Nodular pattern	A collection of innumerable, small discrete opacities ranging in diameter from 2-10 mm, generally uniform in size and widespread in distribution, and without marginal spiculation [Fraser and Pare].	
112068	Pseudoplaque	An irregular band of peripheral pulmonary opacity adjacent to visceral pleura that simulates the appearance of a pleural plaque and is formed by coalescence of small nodules [Fraser and Pare].	
112069	Signet-ring sign	A ring of opacities (usually representing a dilated, thick-walled bronchus) in association with a smaller, round, soft tissue opacity (the adjacent pulmonary artery) suggesting a "signet ring" [Fraser and Pare].	
112070	Air bronchiogram	Equivalent of air bronchogram, but in airways assumed to be bronchioles because of peripheral location and diameter [Fraser and Pare].	
112071	Air bronchogram	Radiographic shadow of an air-containing bronchus; presumed to represent an air-containing segment of the bronchial tree (identity often inferred) [Fraser and Pare].	
112072	Air crescent	Air in a crescentic shape in a nodule or mass, in which the air separates the outer wall of the lesion from an inner sequestrum, which most commonly is a fungus ball of <i>Aspergillus</i> species [Fraser and Pare].	
112073	Halo sign	Ground-glass opacity surrounding the circumference of a nodule or mass. May be a sign of invasive aspergillosis or hemorrhage of various causes [Fraser and Pare].	
112074	Target Lesion at	Flag denoting that this lesion	

	Baseline	was identified, at baseline, as a target lesion intended for tracking over time [RECIST].	
112075	Non-Target Lesion at Baseline	Flag denoting that this lesion was not identified, at baseline, as a target lesion, and was not intended for tracking over time [RECIST].	
112076	Non-Lesion at Baseline	Flag denoting that this finding was identified, at baseline, as a category other than a lesion, and was not intended for tracking over time [RECIST].	
112077	Vasoconstriction	Local or general reduction in the caliber of visible pulmonary vessels, presumed to result from decreased flow occasioned by contraction of muscular pulmonary arteries [Fraser and Pare].	
112078	Vasodilation	Local or general increase in the width of visible pulmonary vessels resulting from increased pulmonary blood flow [Fraser and Pare].	
112079	Architectural distortion	A manifestation of lung disease in which bronchi, pulmonary vessels, a fissure or fissures, or septa of secondary pulmonary lobules are abnormally displaced [Fraser and Pare].	
112080	Mosaic perfusion	A patchwork of regions of varied attenuation, interpreted as secondary to regional differences in perfusion [Fraser and Pare].	
112081	Pleonemia	Increased blood flow to the lungs or a portion thereof, manifested by a general or local increase in the width of visible pulmonary vessels [Fraser and Pare].	
112082	Interface	The common boundary between the shadows of two juxtaposed structures or tissues of different texture or opacity (edge, border) [Fraser and Pare].	
112083	Line	A longitudinal opacity no greater than 2 mm in width [Fraser and Pare].	
112084	Lucency	The shadow of an absorber that attenuates the primary X-ray beam less effectively than do surrounding absorbers. In a	



		radiograph, any circumscribed area that appears more nearly black (of greater photometric density) than its surround [Fraser and Pare].	
112085	Midlung window	A midlung region, characterized by the absence of large blood vessels and by a paucity of small blood vessels, that corresponds to the minor fissure and adjacent peripheral lung [Fraser and Pare].	
112086	Carina angle	The angle formed by the right and left main bronchi at the tracheal bifurcation [Fraser and Pare].	
112087	Centrilobular structures	The pulmonary artery and its immediate branches in a secondary lobule; HRCT depicts these vessels in certain cases; a.k.a. core structures or lobular core structures [Fraser and Pare].	
112088	Anterior junction line	A vertically oriented linear or curvilinear opacity approximately 1-2 mm wide, commonly projected on the tracheal air shadow [Fraser and Pare].	
112089	Posterior junction line	A vertically oriented, linear or curvilinear opacity approximately 2 mm wide, commonly projected on the tracheal air shadow, and usually slightly concave to the right [Fraser and Pare].	
112090	Azygoesophageal recess interface	A space in the right side of the mediastinum into which the medial edge of the right lower lobe extends [Fraser and Pare].	
112091	Paraspinal line	A vertically oriented interface usually seen in a frontal chest radiograph to the left of the thoracic vertebral column [Fraser and Pare].	
112092	Posterior tracheal stripe	A vertically oriented linear opacity ranging in width from 2-5 mm, extending from the thoracic inlet to the bifurcation of the trachea, and visible only on lateral radiographs of the chest [Fraser and Pare].	
112093	Right tracheal stripe	A vertically oriented linear opacity approximately 2-3 mm wide extending from the thoracic	

		inlet to the right tracheobronchial angle [Fraser and Pare].	
112094	Stripe	A longitudinal composite opacity measuring 2-5 mm in width; acceptable when limited to anatomic structures within the mediastinum [Fraser and Pare].	
112095	Hiatus	A gap or passage through an anatomical part or organ; <i>especially</i> : a gap through which another part or organ passes.	
112096	Rib Scalene Tubercle	A small rounded elevation or eminence on the first rib for the attachment of the scalenus anterior.	
112097	Vertebral Intervertebral Notch	A groove that serves for the transmission of the vertebral artery.	
112098	Subscapular Fossa	The concave depression of the anterior surface of the scapula.	
112099	Scapular Spine	A sloping ridge dividing the dorsal surface of the scapula into the supraspinatus fossa (above), and the infraspinatus fossa (below).	
112100	Scapular Supraspinatus Fossa	The portion of the dorsal surface of the scapula above the scapular spine.	
112101	Scapular Infraspinatus Fossa	The portion of the dorsal surface of the scapula below the scapular spine.	
112102	Aortic knob	The portion of the aortic arch that defines the transition between its ascending and descending limbs.	
112103	Arch of the Azygos vein	Section of Azygos vein near the fourth thoracic vertebra, where it arches forward over the root of the right lung, and ends in the superior vena cava, just before that vessel pierces the pericardium.	
112104	Air-fluid level	A local collection of gas and liquid that, when traversed by a horizontal X-ray beam, creates a shadow characterized by a sharp horizontal interface between gas density above and liquid density below [Fraser and Pare].	
112105	Corona radiata	A circumferential pattern of fine linear spicules, approximately 5	

		mm long, extending outward from the margin of a solitary pulmonary nodule through a zone of relative lucency [Fraser and Pare].	
112106	Honeycomb pattern	A number of closely approximated ring shadows representing air spaces 5-10 mm in diameter with walls 2-3 mm thick that resemble a true honeycomb; implies "end-stage" lung [Fraser and Pare]	
112107	Fleischner's line(s)	A straight, curved, or irregular linear opacity that is visible in multiple projections; usually situated in the lower half of the lung; vary markedly in length and width [Fraser and Pare].	
112108	Intralobular lines	Fine linear opacities present in a lobule when the intralobular interstitium is thickened. When numerous, they may appear as a fine reticular pattern [Fraser and Pare].	
112109	Kerley A line	Essentially straight linear opacity 2-6 cm in length and 1-3 mm in width, usually in an upper lung zone [Fraser and Pare].	
112110	Kerley B line	A straight linear opacity 1.5-2 cm in length and 1-2 mm in width, usually at the lung base [Fraser and Pare].	
112111	Kerley C lines	A group of branching, linear opacities producing the appearing of a fine net, at the lung base [Fraser and Pare].	
112112	Parenchymal band	Elongated opacity, usually several millimeters wide and up to about 5 cm long, often extending to the pleura, which may be thickened and retracted at the site of contact [Fraser and Pare].	
112113	Reticular pattern	A collection of innumerable small linear opacities that together produce an appearance resembling a net [Fraser and Pare].	
112114	Septal line(s)	Usually used in the plural, a generic term for linear opacities of varied distribution produced when the interstitium between pulmonary lobules is thickened	

		[Fraser and Pare].	
112115	Subpleural line	A thin curvilinear opacity, a few millimeters or less in thickness, usually less than 1 cm from the pleural surface and paralleling the pleura [Fraser and Pare].	
112116	Tramline shadow	Parallel or slightly convergent linear opacities that suggest the planar projection of tubular structures and that correspond in location and orientation to elements of the bronchial tree [Fraser and Pare].	
112117	Tubular shadow	Paired, parallel, or slightly convergent linear opacities presumed to represent the walls of a tubular structure seen en face; used if the anatomic nature of a shadow is obscure [Fraser and Pare].	
112118	Density	The opacity of a radiographic shadow to visible light; film blackening; the term should never be used to mean an "opacity" or "radiopacity" [Fraser and Pare].	
112119	Dependent opacity	Subpleural increased attenuation in dependent lung. The increased attenuation disappears when the region of lung is nondependent; a.k.a. dependent increased attenuation [Fraser and Pare].	
112120	Ground glass opacity	Hazy increased attenuation of lung, but with preservation of bronchial and vascular margins; caused by partial filling of air spaces, interstitial thickening, partial collapse of alveoli, normal expiration, or increased capillary blood volume [Fraser and Pare].	
112121	Infiltrate	Any ill-defined opacity in the lung [Fraser and Pare].	
112122	Micronodule	Discrete, small, round, focal opacity of at least soft tissue attenuation and with a diameter no greater than 7 mm [Fraser and Pare].	
112123	Phantom tumor (pseudotumor)	A shadow produced by a local collection of fluid in one of the interlobar fissures, usually elliptic in one radiographic projection and rounded in the other,	

		resembling a tumor [Fraser and Pare].	
112124	Shadow	Any perceptible discontinuity in film blackening attributed to the attenuation of the X-ray beam by a specific anatomic absorber or lesion on or within the body of the patient; to be employed only when more specific identification is not possible [Fraser and Pare].	
112125	Small irregular opacities	Term used to define a reticular pattern specific to pneumoconioses [Fraser and Pare].	
112126	Small rounded opacities	Term used to define a nodular pattern specific to pneumoconioses [Fraser and Pare].	
112127	Tree-in-bud sign	Nodular dilation of centrilobular branching structures that resembles a budding tree and represents exudative bronchiolar dilation [Fraser and Pare].	
112128	Granular pattern	Any extended, finely granular pattern of pulmonary opacity within which normal anatomic details are partly obscured [Fraser and Pare].	
112129	Miliary pattern	A collection of tiny discrete opacities in the lungs, each measuring 2 mm or less in diameter, generally uniform in size and widespread in distribution [Fraser and Pare].	
112130	Mosaic pattern	Generalized pattern of relatively well defined areas in the lung having different X-ray attenuations due to a longstanding underlying pulmonary disease.	
112131	Extremely small	A qualitative descriptor of a size that is dramatically less than typical.	
112132	Very small	A qualitative descriptor of a size that is considerably less than typical.	
112133	Too small	A qualitative descriptor of a size that is so small as to be abnormal versus expected size.	
112134	Elliptic	Shaped like an ellipse (oval).	
112135	Lobulated	A border shape that is made up	

		of, provided with, or divided into lobules (small lobes, curved or rounded projections or divisions).	
112136	Spiculated	Radially orientated border shape.	
112137	Sharply defined	The border of a shadow (opacity) is sharply defined [Fraser and Pare].	
112138	Distinctly defined	The border of a shadow (opacity) is distinctly defined [Fraser and Pare].	
112139	Well demarcated	The border of a shadow (opacity) is well distinct from adjacent structures [Fraser and Pare].	
112140	Sharply demarcated	The border of a shadow (opacity) is sharply distinct from adjacent structures [Fraser and Pare].	
112141	Poorly demarcated	The border of a shadow (opacity) is poorly distinct from adjacent structures [Fraser and Pare].	
112142	Circumscribed	A shadow (opacity) possessing a complete or nearly complete visible border [Fraser and Pare].	
112143	Air	Inspired atmospheric gas. The word is sometimes used to describe gas within the body regardless of its composition or site [Fraser and Pare].	
112144	Soft tissue	Material having X-ray attenuation properties similar to muscle.	
112145	Calcium	Material having X-ray attenuation properties similar to calcium, a silver-white bivalent metallic element occurring in plants and animals.	
112146	Acinar	A pulmonary opacity 4-8 mm in diameter, presumed to represent anatomic acinus, or a collection of opacities in the lung, each measuring 4-8 mm in diameter, and together producing an extended, homogeneous shadow [Fraser and Pare].	
112147	Air space	The gas-containing portion of the lung parenchyma, including the acini and excluding the interstitium [Fraser and Pare].	

112148	Fibronodular	Sharply defined, approximately circular opacities occurring singly or in clusters, usually in the upper lobes [Fraser and Pare].	
112149	Fluffy	A shadow (opacity) that is ill-defined, lacking clear-cut margins [Fraser and Pare].	
112150	Linear	A shadow resembling a line; any elongated opacity of approximately uniform width [Fraser and Pare].	
112151	Profusion	The number of small opacities per unit area or zone of lung. In the International Labor Organization (ILO) classification of radiographs of the pneumoconioses, the qualifiers 0 through 3 subdivide the profusion into 4 categories. The profusion categories may be further subdivided by employing a 12-point scale [Fraser and Pare].	
112152	Silhouette sign	The effacement of an anatomic soft tissue border by either a normal anatomic structure or a pathologic state such as airlessness of adjacent lung or accumulation of fluid in the contiguous pleural space; useful in detecting and localizing an opacity along the axis of the X-ray beam [Fraser and Pare].	
112153	Subpleural	Situated or occurring between the pleura and the body wall.	
112154	Bat's wing distribution	Spatial arrangement of opacities that bears vague resemblance to the shape of a bat in flight; bilaterally symmetric [Fraser and Pare].	
112155	Butterfly distribution	Spatial arrangement of opacities that bears vague resemblance to the shape of a butterfly in flight; bilaterally symmetric [Fraser and Pare].	
112156	Centrilobular	Referring to the region of the bronchioarteriolar core of a secondary pulmonary lobule [Fraser and Pare].	
112157	Coalescent	The joining together of a number of opacities into a single opacity [Fraser and Pare].	

112158	Lobar	Of or relating to a lobe (a curved or rounded projection or division). For example, involving an entire lobe of the lung.	
112159	Hyper-acute	Extremely or excessively acute, as a qualitative measure of severity.	
112160	Homogeneous (uniform opacity)	Of uniform opacity or texture throughout [Fraser and Pare].	
112161	Inhomogeneous	Lack of homogeneity in opacity or texture.	
112162	Target	Discrete opacity centrally within a larger opacity, as a calcification descriptor.	
112163	Fibrocalcific	Pertaining to sharply defined, linear, and/or nodular opacities containing calcification(s) [Fraser and Pare].	
112164	Flocculent	Calcifications made up of loosely aggregated particles, resembling wool.	
112165	Difference in border shape	A change in the shape formed by the boundary or edges of a finding or feature.	
112166	Difference in border definition	A change in the clarity of the boundary or edges of a finding or feature.	
112167	Difference in distribution	A change in the extent of spreading of a finding or feature.	
112168	Difference in site involvement	A change in the part(s) of the anatomy affected or encompassed by a finding or feature.	
112169	Difference in Type of Content	A change in the matter or substance within a finding or feature.	
112170	Difference in Texture	A change in the surface or consistency of a finding or feature.	
112171	Fiducial mark	A location in image space, which may or may not correspond to an anatomical reference, which is often used for registering data sets.	
112172	Portacath	Connected to an injection chamber placed under the skin in the upper part of the chest. When it is necessary to inject some drug, a specific needle is put in the chamber through the skin and a silicon membrane.	



		The advantage of a portacath is that it may be left in place several months contrarily of "classical" cathethers.	
112173	Chest tube	A tube inserted into the chest wall from outside the body, for drainage. Sometimes used for collapsed lung. Usually connected to a receptor placed lower than the insertion site.	
112174	Central line	A tube placed into the subclavian vein to deliver medication directly into the venous system.	
112175	Kidney stent	A stent is a tube inserted into another tube. Kidney stent is a tube that is inserted into the kidney, ureter, and bladder, to help drain urine. Usually inserted through a scoping device presented through the urethra.	
112176	Pancreatic stent	A stent is a tube inserted into another tube. Pancreatic stent is inserted through the common bile duct to the pancreatic duct, to drain bile.	
112177	Nipple ring	A non-lesion object which appears to be a circular band, attached to the body via pierced nipple.	
112178	Coin	A non-lesion object which appears to be a flat round piece of metal.	
112179	Minimum Attenuation Coefficient	The least quantity assignable, admissible, or possible; the least of a set of X-ray attenuation coefficients.	
112180	Maximum Attenuation Coefficient	The greatest quantity or value attainable or attained; the largest of a set of X-ray attenuation coefficients.	
112181	Mean Attenuation Coefficient	The value that is computed by dividing the sum of a set of X-ray attenuation coefficients by the number of values.	
112182	Median Attenuation Coefficient	The value in an ordered set of X-ray attenuation coefficients, below and above which there is an equal number of values.	
112183	Standard Deviation of Attenuation	For a set of X-ray attenuation coefficients: 1) a measure of the	

	Coefficient	dispersion of a frequency distribution that is the square root of the arithmetic mean of the squares of the deviation of each of the class frequencies from the arithmetic mean of the frequency distribution; 2) a parameter that indicates the way in which a probability function or a probability density function is centered around its mean and that is equal to the square root of the moment in which the deviation from the mean is squared.	
112184	Performance of Pediatric and Adult Thoracic CT	American College of Radiology. ACR Standard for the Performance of Pediatric and Adult Thoracic Computed Tomography (CT). In: Standards. Reston, Va: 2001:103-107.	
112185	Performance of CT for Detection of Pulmonary Embolism in Adults	American College of Radiology. ACR Standard for the Performance of Computed Tomography for the Detection of Pulmonary Embolism in Adults. In: Standards. Reston, Va: 2001:109-113.	
112186	Performance of High-Resolution CT of the Lungs in Adults	American College of Radiology. ACR Standard for the Performance of High-Resolution Computed Tomography (HRCT) of the Lungs in Adults. In: Standards. Reston, Va: 2001:115-118.	
112187	Unspecified method of calculation	The method of calculation of a measurement or other type of numeric value is not specified.	
112191	Breast tissue density	The relative density of parenchymal tissue as a proportion of breast volume	
112192	Volume of parenchymal tissue	The volume of parenchymal tissue	
112193	Volume of breast	The volume of the breast	
112194	Mass of parenchymal tissue	The mass of parenchymal tissue	
112195	Mass of breast	The mass of the breast	
112196	Area of Vascular Calcification	A measured or calculated area of vascular calcification	
112197	Volume of Vascular Calcification	A measured or calculated volume of vascular calcification	

112198	Percentage of Vascular Calcification	A measured or calculated percentage of vascular calcification	
112199	Mass of Vascular Calcification	A measured or calculated mass of vascular calcification	
113000	Of Interest	Of Interest	
113001	Rejected for Quality Reasons	Rejected for Quality Reasons	
113002	For Referring Provider	For Referring Provider	
113003	For Surgery	For Surgery	
113004	For Teaching	For Teaching	
113005	For Conference	For Conference	
113006	For Therapy	For Therapy	
113007	For Patient	For Patient	
113008	For Peer Review	For Peer Review	
113009	For Research	For Research	
113010	Quality Issue	Quality Issue	
113011	Document Title Modifier	Document Title Modifier	
113012	Key Object Description	Key Object Description	
113013	Best In Set		
113014	Study		
113015	Series		
113016	Performed Procedure Step		
113017	Stage-View		
113018	For Printing	For Printing	
113020	For Report Attachment	Selection of information objects for attachment to the clinical report of the Current Requested Procedure	
113026	Double exposure	Double exposure	
113030	Manifest	A list of objects that have been exported out of one organizational domain into another domain. Typically, the first domain has no direct control over what the second domain will do with the objects.	
113031	Signed Manifest	A signed list of objects that have been exported out of one organizational domain into another domain, referenced securely with either Digital Signatures or MACs. Typically,	

		the first domain has no direct control over what the second domain will do with the objects.	
113032	Complete Study Content	The list of objects that constitute a study at the time that the list was created.	
113033	Signed Complete Study Content	The signed list of objects that constitute a study at the time that the list was created, referenced securely with either Digital Signatures or MACs.	
113034	Complete Acquisition Content	The list of objects that were generated in a single procedure step.	
113035	Signed Complete Acquisition Content	The signed list of objects that were generated in a single procedure step, referenced securely with either Digital Signatures or MACs.	
113036	Group of Frames for Display	A list of frames or single-frame or entire multi-frame instances that together constitute a set for some purpose, such as might be displayed together in the same viewport, as distinct from another set that might be displayed in a separate viewport.	
113040	Lossy Compression	Lossy compression has been applied to an image.	
113041	Apparent Diffusion Coefficient	The image is derived by calculation of the apparent diffusion coefficient.	
113042	Pixel by pixel addition	The image is derived by the pixel by pixel addition of two images.	
113043	Diffusion weighted	The image is derived by calculation of the diffusion weighting.	
113044	Diffusion Anisotropy	The image is derived by calculation of the diffusion anisotropy.	
113045	Diffusion Attenuated	The image is derived by calculation of the diffusion attenuation.	
113046	Pixel by pixel division	The image is derived by the pixel by pixel division of two images.	
113047	Pixel by pixel mask	The image is derived by the pixel by pixel masking of one image by another.	
113048	Pixel by pixel Maximum	The image is derived by calculating the pixel by pixel maximum of two or more	

		images.	
113049	Pixel by pixel mean	The image is derived by calculating the pixel by pixel mean of two or more images.	
113050	Metabolite Maps from spectroscopy data	The image is derived by calculating from spectroscopy data pixel values localized in two dimensional space based on the concentration of specific metabolites (i.e, at specific frequencies).	
113051	Pixel by pixel Minimum	The image is derived by calculating the pixel by pixel minimum of two or more images.	
113052	Mean Transit Time	The image is derived by calculating mean transit time values.	
113053	Pixel by pixel multiplication	The image is derived by the pixel by pixel multiplication of two images.	
113054	Negative Enhancement Integral	The image is derived by calculating negative enhancement integral values.	
113055	Regional Cerebral Blood Flow	The image is derived by calculating regional cerebral blood flow values.	
113056	Regional Cerebral Blood Volume	The image is derived by calculating regional cerebral blood volume values.	
113057	R-Coefficient Map	The image is derived by calculating R-Coefficient map values	
113058	Proton Density map	The image is derived by calculating proton density values.	
113059	Signal Change Map	The image is derived by calculating signal change values.	
113060	Signal to Noise Map	The image is derived by calculating the signal to noise ratio.	
113061	Standard Deviation	The image is derived by calculating the standard deviation of two or more images.	
113062	Pixel by pixel subtraction	The image is derived by the pixel by pixel subtraction of two images.	
113063	T1 Map	The image is derived by calculating T1 values.	
113064	T2* Map	The image is derived by calculating T2* values.	

113065	T2 Map	The image is derived by calculating T2 values.	
113066	Time Course of Signal	The image is derived by calculating values based on the time course of signal.	
113067	Temperature encoded	The image is derived by calculating values based on temperature encoding.	
113068	Student's T-Test	The image is derived by calculating the value of the Student's T-Test statistic from multiple image samples.	
113069	Time To Peak map	The image is derived by calculating values based on the time to peak.	
113070	Velocity encoded	The image is derived by calculating values based on velocity encoded (e.g., phase contrast).	
113071	Z-Score Map	The image is derived by calculating the value of the Z-Score statistic from multiple image samples.	
113072	Multiplanar reformatting	The image is derived by reformatting in a flat plane other than that originally acquired.	
113073	Curved multiplanar reformatting	The image is derived by reformatting in a curve plane other than that originally acquired.	
113074	Volume rendering	The image is derived by volume rendering of acquired data.	
113075	Surface rendering	The image is derived by surface rendering of acquired data.	
113076	Segmentation	The image is derived by segmentation (classification into tissue types) of acquired data.	
113077	Volume editing	The image is derived by selectively editing acquired data (removing values from the volume), such as in order to remove obscuring structures or noise.	
113078	Maximum intensity projection	The image is derived by maximum intensity projection of acquired data.	
113079	Minimum intensity projection	The image is derived by minimum intensity projection of acquired data.	
113080	Glutamate and glutamine	For single-proton MR spectroscopy, the resonance	

	glutamine	peak corresponding to glutamate and glutamine.	
113081	Choline/Creatine Ratio	For single-proton MR spectroscopy, the ratio between the Choline and Creatine resonance peaks.	
113082	N-acetylaspartate /Creatine Ratio	For single-proton MR spectroscopy, the ratio between the N-acetylaspartate and Creatine resonance peaks.	
113083	N-acetylaspartate /Choline Ratio	For single-proton MR spectroscopy, the ratio between the N-acetylaspartate and Choline resonance peaks.	
113085	Spatial resampling	The image is derived by spatial resampling of acquired data.	
113086	Edge enhancement	The image is derived by edge enhancement.	
113087	Smoothing	The image is derived by smoothing.	
113088	Gaussian blur	The image is derived by Gaussian blurring.	
113089	Unsharp mask	The image is derived by unsharp masking.	
113090	Image stitching	The image is derived by stitching two or more images together.	
113611	Stationary Acquisition	Acquisition where the x-ray source does not move in relation to the patient	
113612	Stepping Acquisition	Acquisition where the x-ray source moves laterally in relation to the patient	
113613	Rotational Acquisition	Acquisition where the x-ray source moves angularly in relation to the patient	
113620	Plane A	Primary plane of a Biplane acquisition equipment	
113621	Plane B	Secondary plane of a Biplane acquisition equipment	
113622	Single Plane	Single plane acquisition equipment	
113630	Continuous	Continuous x-ray radiation is applied during an irradiation event	
113631	Pulsed	Pulsed x-ray radiation is applied during an irradiation event	
113650	Strip filter	Filter with uniform thickness	
113651	Wedge filter	Filter with variation in thickness from one edge to the opposite	

		edge	
113652	Butterfly filter	Filter with two triangular sections	
113661	Outline of lobulations	A polyline defining the outline of a lobulated finding	
113662	Inner limits of fuzzy margin	A polyline defining the inner limits of a finding with fuzzy margin	
113663	Outer limits of fuzzy margin	A polyline defining the outer limits of a finding with fuzzy margin	
113664	Outline of spiculations	A polyline defining the outline of the spiculations of a finding	
113665	Linear spiculation	A polyline segment graphically indicating the location and direction of a spiculation of a finding	
113666	Pixelated spiculations	A collection of points indicating the pixel locations of the spiculations of a finding	
113669	Orthogonal location arc	Connected line segments indicating the center of location of a finding on an orthogonal view	
113670	Orthogonal location arc inner margin	Connected line segments indicating the inner margin of the location of a finding on an orthogonal view	
113671	Orthogonal location arc outer margin	Connected line segments indicating the outer location of a finding on an orthogonal view	
113681	Phantom	An artificial subject of an imaging study.	
113682	ACR Accreditation Phantom - CT	A phantom acceptable for the ACR Computed Tomography Accreditation program	
113683	ACR Accreditation Phantom - MR	A phantom acceptable for the ACR Magnetic Resonance Imaging Accreditation program	
113684	ACR Accreditation Phantom - Mammography	A phantom acceptable for the ACR Mammography Accreditation program	
113685	ACR Accreditation Phantom – Stereotactic Breast Biopsy	A phantom acceptable for the ACR Stereotactic Breast Biopsy Accreditation program	
113686	ACR Accreditation Phantom - ECT	A phantom acceptable for the ACR SPECT Accreditation program (but not for PET)	
113687	ACR Accreditation Phantom - PET	A phantom acceptable for the ACR PET Accreditation program	



		(but not for SPECT)	
113688	ACR Accreditation Phantom – ECT/PET	A SPECT phantom with a PET faceplate acceptable for both the ACR SPECT and PET Accreditation programs	
113689	ACR Accreditation Phantom – PET Faceplate	A PET faceplate (made to fit an existing flangeless or flanged ECT phantom) acceptable for the ACR PET Accreditation program	
113690	IEC Head Dosimetry Phantom	A phantom acceptable for head dosimetry measurements according to IEC 60601-2-44, Ed.2.1	
113691	IEC Body Dosimetry Phantom	A phantom acceptable for body dosimetry measurements according to IEC 60601-2-44, Ed.2.1	
113692	NEMA XR21-2000 Phantom	A phantom in accordance with NEMA standard XR-21-2000	
113701	X-Ray Radiation Dose Report	X-Ray Radiation Dose Report	
113702	Accumulated X-Ray Dose Data	X-Ray dose data accumulated over multiple irradiation events, e.g., for a study or a performed procedure step	
113704	Projection X-Ray	Imaging using a point X-ray source with a diverging beam projected onto a 2 dimensional detector	
113705	Scope of Accumulation	Entity over which dose accumulation values are integrated	
113706	Irradiation Event X-Ray Data	X-Ray dose data for a single Irradiation Event	
113710	Niobium or Niobium compound	Material containing Niobium or a Niobium compound	
113711	Europium or Europium compound	Material containing Europium or a Europium compound	
113721	Irradiation Event Type	Denotes the type of irradiation event recorded	
113722	Dose Area Product Total	Total calculated Dose Area Product (in the scope of the including report)	
113723	Calibration Date	Last calibration Date for the integrated dose meter or dose calculation	
113724	Calibration Responsible Party	Individual or organization responsible for calibration	
113725	Dose (RP) Total	Total Dose related to Reference	

		Point (RP). (in the scope of the including report)	
113726	Fluoro Dose Area Product Total	Total calculated Dose Area Product applied in Fluoroscopy Modes (in the scope of the including report).	
113727	Acquisition Dose Area Product Total	Total calculated Dose Area Product applied in Acquisition Modes (in the scope of the including report).	
113728	Fluoro Dose (RP) Total	Dose applied in Fluoroscopy Modes, related to Reference Point (RP). (in the scope of the including report)	
113729	Acquisition Dose (RP) Total	Dose applied in Acquisition Modes, related to Reference Point (RP). (in the scope of the including report)	
113730	Total Fluoro Time	Total accumulated time of Fluoroscopy (in the scope of the including report)	
113731	Total Number of Radiographic Frames	Accumulated Count of Frames (single or multi-frame) created from irradiation events performed with high dose (acquisition).	
113732	Fluoro Mode	Mode of application of X-Rays during Fluoroscopy	
113733	KVP	Applied X-Ray Tube voltage at peak of X-ray generation, in kilovolts; Mean value if measured over multiple peaks (pulses)	
113734	X-Ray Tube Current	Mean value of applied Tube Current	
113735	Exposure Time	Cumulative time the patient has received X-Ray exposure during the irradiation event	
113736	Exposure	Mean value of X-Ray Current Time product	
113737	Distance Source to Reference Point	Distance to the Reference Point (RP) defined according to IEC 60601-2-43 or equipment defined.	
113738	Dose (RP)	Dose applied at the Reference Point (RP).	
113739	Positioner Primary End Angle	Positioner Primary Angle at the end of an irradiation event. For further definition see (112011,DCM,"Positioner Primary Angle")	

113740	Positioner Secondary End Angle	Positioner Secondary Angle at the end of an irradiation event. For further definition see (112012,DCM,"Positioner Secondary Angle")	
113742	Irradiation Duration	Clock time from the start of the first irradiation in the irradiation event until the end of the last irradiation in the same irradiation event. For continuous modes this the time the irradiation intensity is above a 50% threshold with respect to the maximum intensity achieved during an irradiation event.	
113743	Patient Orientation	Orientation of the Patient with respect to Gravity	
113744	Patient Orientation Modifier	Enhances or modifies the Patient orientation specified in Patient Orientation	
113745	Patient Table Relationship	Orientation of the Patient with respect to the Head of the Table	
113748	Distance Source to Isocenter	Distance from the X-Ray Source to the Equipment C-Arm Isocenter.(Center of Rotation).	
113750	Distance Source to Detector	Measured or calculated distance from the X-Ray source to the detector plane in the center of the beam.	
113751	Table Longitudinal Position	Table Longitudinal Position with respect to an arbitrary chosen reference by the equipment. Table motion towards LAO is positive assuming that the patient is positioned supine and its head is in normal position.	
113752	Table Lateral Position	Table Lateral Position with respect to an arbitrary chosen reference by the equipment. Table motion towards CRA is positive assuming that the patient is positioned supine and its head is in normal position.	
113753	Table Height Position	Table Height Position with respect to an arbitrary chosen reference by the equipment in (mm). Table motion downwards is positive	
113754	Table Head Tilt Angle	Angle of the head-feet axis of the table in degrees relative to the horizontal plane. Positive values indicate that the head of the table is upwards.	

113755	Table Horizontal Rotation Angle	Rotation of the table in the horizontal plane (clockwise when looking from above the table).	
113756	Table Cradle Tilt Angle	Angle of the left-right axis of the table in degrees relative to the horizontal plane. Positive values indicate that the left of the table is upwards.	
113757	X-Ray Filter Material	X-Ray absorbing material used in the filter.	
113758	X-Ray Filter Thickness Minimum	The minimum thickness of the X-Ray absorbing material used in the filters.	
113763	Calibration Uncertainty	Uncertainty of the 'actual' value.	
113764	Acquisition Plane	Identification of Acquisition Plane with Biplane systems.	
113766	Focal Spot Size	Nominal Size of Focal Spot of X-Ray Tube	
113767	Average X-Ray Tube Current	Average X-Ray Tube Current averaged over time for pulse or for continuous Fluoroscopy	
113768	Number of Pulses	Number of pulses applied by X-Ray systems during an irradiation event (acquisition run or pulsed fluoro)	
113769	Irradiation Event UID	Unique identification of a single irradiation event	
113770	Column Angulation	Angle of the X-Ray beam in degree relative to an orthogonal axis to the detector plane.	
113771	X-Ray Filters	Devices used to modify the energy or energy distribution of X-rays	
113772	X-Ray Filter Type	Type of filter(s) inserted into the X-Ray beam (e.g. wedges).	
113773	X-Ray Filter Thickness Maximum	The maximum thickness of the X-Ray absorbing material used in the filters.	
113780	Reference Point Definition	System provided definition of the Reference Point used for Dose calculations.	
113790	Collimated Field Area	Collimated field area at image receptor. Area for compatibility with IEC 60601-2-43.	
113791	Pulse Rate	Pulse rate applied by equipment during Fluoroscopy	
113792	Distance Source to Table Plane	Measured or calculated distance from the X-Ray source to the table plane in the center of the	

		beam.	
113793	Pulse Width	(Average) X-ray pulse width	
113794	Dose Measurement Device	Calibrated device to perform dose measurements.	
113795	Acquired Image	Image acquired during a specified event.	
114000	Not a number	Measurement not available: Not a number (per IEEE 754)	
114001	Negative Infinity	Measurement not available: Negative Infinity (per IEEE 754)	
114002	Positive Infinity	Measurement not available: Positive Infinity (per IEEE 754)	
114003	Divide by zero	Measurement not available: Divide by zero (per IEEE 754)	
114004	Underflow	Measurement not available: Underflow (per IEEE 754)	
114005	Overflow	Measurement not available: Overflow (per IEEE 754)	
114006	Measurement failure	Measurement not available: Measurement failure	
114007	Measurement not attempted	Measurement not available: Measurement not attempted	
114008	Calculation failure	Measurement not available: Calculation failure	
114009	Value out of range	Measurement not available: Value out of range	
114010	Value unknown	Measurement not available: Value unknown	
114011	Value indeterminate	Measurement not available: Value indeterminate	
121001	Quotation Mode	Type of source for observations quoted from an external source	
121002	Quoted Source	Reference to external source of quoted observations	
121003	Document	Documentary source of quoted observations	
121004	Verbal	Verbal source of quoted observations	
121005	Observer Type	Type of observer that created the observations	
121006	Person	Human observer created the observations	
121007	Device	Automated device created the observations	
121008	Person Observer Name	Name of human observer that created the observations	
121009	Person Observer's	Organization or institution with	

	Organization Name	which the human observer is affiliated for the context of the current observation	
121010	Person Observer's Role in the Organization	Organizational role of human observer for the context of the current observation	
121011	Person Observer's Role in this Procedure	Procedural role of human observer for the context of the current observation	
121012	Device Observer UID	Unique identifier of automated device that created the observations	
121013	Device Observer Name	Institution-provided identifier of automated device that created the observations	
121014	Device Observer Manufacturer	Manufacturer of automated device that created the observations	
121015	Device Observer Model Name	Manufacturer-provided model name of automated device that created the observations	
121016	Device Observer Serial Number	Manufacturer-provided serial number of automated device that created the observations	
121017	Device Observer Physical Location During Observation	Location of automated device that created the observations whilst the observations were being made.	
121018	Procedure Study Instance UID		
121019	Procedure Study Component UID		
121020	Procedure HL7 Placer Number of Evidence		
121021	Procedure HL7 Filler Number of Evidence		
121022	Procedure Accession Number		
121023	Procedure Code		
121024	Subject Class	Type of observation subject	
121025	Patient	A patient is the subject of observations	
121026	Fetus	Fetus of patient is the subject of observations	
121027	Specimen	Specimen is the subject of observations	
121028	Subject UID	Unique Identifier of patient or fetus who is the subject of observations	

121029	Subject Name	Name of patient who is the subject of observations	
121030	Subject ID	Identifier of patient or fetus who is the subject of observations	
121031	Subject Birth Date	Birth Date of patient who is the subject of observations	
121032	Subject Sex	Sex of patient who is the subject of observations	
121033	Subject Age	Age of patient who is the subject of observations	
121034	Subject Species	Species of patient who is the subject of observations	
121035	Subject Breed	The breed of the subject	
121036	Mother of fetus	Name of mother of fetus which is the subject of observations	
121037	<i>Fetus number</i>		<i>Retired. Replaced with (11951-1, LN, "Fetus ID").</i>
121038	<i>Number of Fetuses</i>		<i>Retired. Replaced with (11878-6, LN, "Number of Fetuses").</i>
121039	Specimen UID	Unique Identifier of specimen which is the subject of observations	
121040	Specimen Accession Number	Accession Number of specimen which is the subject of observations	
121041	Specimen Identifier	Identifier of specimen which is the subject of observations	
121042	Specimen Type	Coded category of specimen which is the subject of observations	
121043	Slide Identifier	Identifier of specimen microscope slide which is the subject of observations	
121044	Slide UID	Unique Identifier of specimen microscope slide which is the subject of observations	
121045	Language		
121046	Country of Language		
121047	Language of Value		
121048	Language of Name and Value		
121049	Language of Content Item and Descendants		
121050	Equivalent Meaning of Concept Name		
121051	Equivalent Meaning of Value		

121052	Presence of property		
121053	<i>Present</i>		<i>Retired. Replaced with (G A203, SRT, "Present")</i>
121054	<i>Absent</i>		<i>Retired. Replaced with (R 4089B, SRT, "Absent")</i>
121055	Path	A set of points on an image, that when connected by line segments, provide a polyline from which a linear measurement was inferred	
121056	Area outline	A set of points on an image, that when connected by line segments, provide a closed polyline that is the border of a defined region from which an area, or two-dimensional measurement, was inferred	
121057	Perimeter outline	A set of points on an image, that when connected by line segments, provide a closed polyline that is a two-dimensional border of a three-dimensional region's intersection with, or projection into the image	
121058	Procedure reported		
121059	<i>Presence Undetermined</i>	<i>Presence or absence of a property is undetermined</i>	<i>Retired. Replaced with (R 4089B, SRT, "Undetermined")</i>
121060	History		
121062	Request		
121064	Current Procedure Descriptions		
121065	Procedure Description		
121066	Prior Procedure Descriptions		
121068	Previous Findings		
121069	Previous Finding		
121070	Findings		
121071	Finding		
121072	Impressions		
121073	Impression		
121074	Recommendations		
121075	Recommendation		
121076	Conclusions		
121077	Conclusion		
121078	Addendum		
121079	Baseline		



121080	Best illustration of finding		
121081	Physician		
121082	Nurse		
121083	Technologist		
121084	Radiographer		
121085	Intern		
121086	Resident		
121087	Registrar		
121088	Fellow		
121089	Attending [Consultant]		
121090	Scrub nurse		
121091	Surgeon		
121092	Sonologist		
121093	Sonographer		
121094	Performing		
121095	Referring		
121096	Requesting		
121097	Recording		
121098	Verifying		
121099	Assisting		
121100	Circulating		
121101	Standby		
121102	Other sex	Other sex	
121103	Undetermined sex	Sex of subject undetermined at time of encoding	
121104	Ambiguous sex	Ambiguous sex	
121105	Radiation Physicist	Radiation Physicist	
121106	Comment	Comment	
121109	Indications for Procedure	Indications for Procedure	
121110	Patient Presentation	Patient condition at the beginning of a healthcare encounter	
121111	Summary	Summary of a procedure, including most significant findings	
121112	Source of measurement	Image or waveform used as source for measurement	
121113	Complications	Complications from a procedure	
121114	Performing Physician	Physician who performed a procedure	
121115	Discharge Summary	Summary of patient condition	

		upon Discharge from a healthcare facility	
121116	Proximal Finding Site	Proximal Anatomic Location for a differential measurement (e.g., distance or pressure gradient); may be considered subtype of term (G-C0E3, SRT, "Finding Site")	
121117	Distal Finding Site	Distal Anatomic Location for a differential measurement (e.g., distance or pressure gradient); may be considered subtype of term (G-C0E3, SRT, "Finding Site")	
121118	Patient Characteristics	Patient Characteristics (findings)	
121120	Cath Lab Procedure Log	Time-stamped record of events that occur during a catheterization procedure	
121121	Room identification	Room identification	
121122	Equipment identification	Equipment identification	
121123	Patient Status or Event	A recorded Patient Status or an event involving a patient	
121124	Procedure Action Item ID	Identification of a step, action, or phase of a procedure	
121125	DateTime of Recording of Log Entry	DateTime of Recording of an Entry in an Event Log	
121126	Performed Procedure Step SOP Instance UID	SOP Instance UID of a DICOM Modality Performed Procedure Step (MPPS) or General Purpose Performed Procedure Step (GPPPS)	
121127	Performed Procedure Step SOP Class UID	SOP Class UID for a DICOM Modality Performed Procedure Step (MPPS) or General Purpose Performed Procedure Step (GPPPS) Service	
121128	Procedure Action Duration	Duration of a step, action, or phase of a procedure	
121130	Start Procedure Action Item	Beginning of a step, action, or phase of a procedure	
121131	End Procedure Action Item	End of a step, action, or phase of a procedure	
121132	Suspend Procedure Action Item	Suspension of a step, action, or phase of a procedure	
121133	Resume Procedure Action Item	Resumption of a step, action, or phase of a procedure	
121135	Observation Datetime Qualifier	Concept modifier for the DateTime of Recording of an	

	Qualifier	Entry in an Event Log	
121136	DateTime Unsynchronized	Recorded DateTime had its source in a system clock not synchronized to other recorded DateTimes	
121137	DateTime Estimated	Recorded DateTime is estimated	
121138	Image Acquired	Event of the acquisition of an image	
121139	Modality	Type of data acquisition device	
121140	Number of Frames	Number of Frames in a multi-frame image	
121141	Image Type	Descriptor of an Image	
121142	Acquisition Duration	Duration of the acquisition of an image or a waveform	
121143	Waveform Acquired	Event of the acquisition of an image	
121144	Document Title	Document Title	
121145	Description of Material	Description of Material used in a procedure	
121146	Quantity of Material	Quantity of Material used in a procedure	
121147	Billing Code	Billing Code for materials used in a procedure	
121148	Unit Serial Identifier	Unit or Device Serial Identifier	
121149	Lot Identifier	Lot Identifier	
121150	Device Code	Vendor or local coded value identifying a device	
121151	Lesion Identifier	Identification of a Lesion observed during an imaging procedure	
121152	Person administering drug/contrast	Person administering drug/contrast	
121153	Lesion Risk	Assessment of the risk a coronary lesion presents to the health of a patient	
121154	Intervention attempt identifier	Identifier for an attempted Intervention	
121155	Deployment	Use of a device to deploy another device	
121156	Percutaneous Entry Action	Action of a clinical professional at the site of percutaneous access to a patient's cardiovascular system	
121157	Begin Circulatory Support	The action or event of beginning circulatory support for a patient	
121158	End Circulatory Support	The action or event of ending circulatory support for a patient	

121160	Oxygen Administration Rate	Rate of Oxygen Administration	
121161	Begin Oxygen Administration	The action or event of beginning administration of oxygen to a patient	
121162	End oxygen administration	The action or event of ending administration of oxygen to a patient	
121163	By ventilator	Method of administration of oxygen to a patient by ventilator	
121165	Patient Assessment Performed	The action or event of assessing the clinical status of a patient	
121166	Begin Pacing	The action or event of beginning pacing support for a patient	
121167	End Pacing	The action or event of ending pacing support for a patient	
121168	Begin Ventilation	The action or event of beginning ventilation support for a patient	
121169	End Ventilation	The action or event of ending ventilation support for a patient	
121171	Tech Note	Procedural note originated by a technologist	
121172	Nursing Note	Procedural note originated by a nurse	
121173	Physician Note	Procedural note originated by a Physician	
121174	Procedure Note	General procedural note	
121180	Key Images	List of references to images considered significant	
121181	DICOM Object Catalog	List of references to DICOM SOP Instances	
121201	<i>Area Outline</i>		<i>Retired. Duplicate of (121056, DCM, "Area Outline") and not used.</i>
121202	<i>Area of Defined Region</i>		<i>Retired. Replaced with (G-A16A, SRT, "Area of defined region").</i>
121206	Distance	A one dimensional, or linear, numeric measurement	
121207	Height	Vertical measurement value	
121210	<i>Path</i>		<i>Retired. Duplicate of (121055, DCM, "Path") and not used.</i>
121211	Path length	A one dimensional, or linear, numeric measurement along a polyline	
121213	<i>Perimeter Outline</i>		<i>Retired. Duplicate of (121057, DCM, "Perimeter</i>

			<i>Outline”) and not used.</i>
121216	Volume estimated from single 2D region	A three-dimensional numeric measurement that is approximate, based on a two-dimensional region in a single image	
121217	Volume estimated from three or more non-coplanar 2D regions	A three-dimensional numeric measurement that is approximate, based on three or more non-coplanar two-dimensional image regions	
121218	Volume estimated from two non-coplanar 2D regions	A three-dimensional numeric measurement that is approximate, based on two non-coplanar two-dimensional image regions	
121219	Volume of bounding three dimensional region	A three-dimensional numeric measurement of the bounding region of a three-dimensional region of interest in an image set	
121220	Volume of circumscribed sphere	A three-dimensional numeric measurement of the bounding sphere of a three-dimensional region of interest in an image set	
121221	Volume of ellipsoid	A three-dimensional numeric measurement of an ellipsoid shaped three-dimensional region of interest in an image set	
121222	Volume of sphere	A three-dimensional numeric measurement of a sphere shaped three-dimensional region of interest in an image set	
121230	Path Vertex	Coordinates of a point on a defined path	
121242	Distance from nipple	Indicates the location of the area of interest as measured from the nipple of the breast.	
121243	Distance from skin	Indicates the location of the area of interest as measured from the most direct skin point of the breast.	
121244	Distance from chest wall	Indicates the location of the area of interest as measured from the chest wall.	
121301	Simultaneous Doppler		
121302	Simultaneous Hemodynamic		
121303	Simultaneous ECG		
121304	Simultaneous Voice Narrative		

121311	Localizer	Image providing an anatomical reference on the patient under examination, for the purpose of defining the location of the ensuing imaging.	
121312	Biopsy localizer	Image providing an anatomical reference on the patient under examination, for the purpose of planning or documenting a biopsy.	
121313	Other partial views	Image providing a partial view of the target anatomy, when the target anatomy is too large for a single image.	
121314	Other image of biplane pair	Image providing a view of the target anatomy in a different imaging plane, typically from a near perpendicular angle	
121315	Other image of stereoscopic pair	Image providing a view of the target anatomy in a different imaging plane, typically with a small angular difference	
121316	Images related to standalone object	Image related to a non-image information object	
121317	Spectroscopy	Image where signals are identified and separated according to their frequencies, e.g., to identify individual chemicals, or individual nuclei in a chemical compound.	
121320	Uncompressed predecessor	An image that has not already been lossy compressed that is used as the source for creation of a lossy compressed image	
121321	Mask image for image processing operation	Image used as the mask for an image processing operation, such as subtraction	
121322	Source image for image processing operation	Image used as the source for an image processing operation	
121324	Source Image	Image used as the source for a derived or compressed image	
121325	Lossy compressed image	Image encoded with a lossy compression transfer syntax	
121326	Alternate SOP Class instance	SOP Instance encoded with a different SOP Class but otherwise equivalent data	
121327	Full fidelity image	Full fidelity image, uncompressed or lossless compressed	
121328	Alternate	Image encoded with a different	

	Photometric Interpretation image	photometric interpretation	
121329	Source image for montage	Image used as a source for a montage (stitched) image	
121330	Lossy compressed predecessor	An image that has previously been lossy compressed that is used as the source for creation of another lossy compressed image	
121331	Equivalent CDA Document	HL7 Document Architecture (CDA) Document that contains clinical content equivalent to the referencing Instance	
121332	Complete Rendering for Presentation	Instance that contains a displayable complete rendering of the referencing Instance	
121333	Partial Rendering for Presentation	Instance that contains a displayable partial rendering of the referencing Instance	
121334	Extended Rendering for Presentation	Instance that contains a displayable complete rendering of the referencing Instance, plus additional content such as inline rendering of referenced images	
121335	Source Document	Document whose content has been wholly or partially transformed to create the referencing document	
121338	Anatomic image	Image showing structural anatomic features	
121339	Functional image	Image showing physical or chemical activity	
121340	Spectral filtered image	Image providing the same view of the target anatomy acquired using only a specific imaging wavelength, frequency or energy	
121341	Device localizer	Image providing an anatomical reference on the patient under examination, for the purpose of documenting the location of device such as a diagnostic or therapeutic catheter.	
121401	Derivation	Method of deriving or calculating a measured value (e.g., mean, or maximum of set)	
121402	Normality	Assessment of a measurement relative to a normal range of values; may be considered subtype of term (G-C0F2, SRT, "has interpretation")	
121403	Level of Significance	Significance of a measurement	

121404	Selection Status	Status of selection of a measurement for further processing or use	
121405	Population description	Description of a population of measurements	
121406	Reference Authority	Bibliographic or clinical reference for a Description of a population of measurements	
121407	Normal Range description	Description of a normal range of values for a measurement concept	
121408	Normal Range Authority	Bibliographic or clinical reference for a Description of a normal range of values	
121410	User chosen value	Observation value selected by user for further processing or use, or as most representative	
121411	Most recent value chosen	Observation value is the recently obtained, and has been selected for further processing or use	
121412	Mean value chosen	Observation value is the mean of several measurements, and has been selected for further processing or use	
121414	Standard deviation of population	Standard deviation of a measurement in a reference population	
121415	Percentile Ranking of measurement	Percentile Ranking of an observation value with respect a reference population	
121416	Z-Score of measurement	Z-score of an observation value with respect a reference population, expressed as the dimensionless quantity $(x-m)/s$ , where $(x-m)$ is the deviation of the observation value ( $x$ ) from the population mean ( $m$ ), and $s$ is the standard deviation of the population.	
121417	2 Sigma deviation of population	2 Sigma deviation of a measurement in a reference population	
121420	Equation	Formula used to compute a derived measurement	
121421	Equation Citation	Bibliographic reference to a formula used to compute a derived measurement; reference may be to a specific equation in a journal article	
121422	Table of Values Citation	Bibliographic reference to a Table of Values used to look up	



		a derived measurement	
121423	Method Citation	Bibliographic reference to a method used to compute a derived measurement	
121424	Table of Values	A Table of Values used to look up a derived measurement	
121425	Index	Factor (divisor or multiplicand) for normalizing a measurement; e.g., body surface area used for normalizing hemodynamic measurements	
121427	<i>Estimated</i>	<i>Measurement obtained by observer estimation, rather than with a measurement tool or by calculation</i>	<i>Retired. Replaced with (R 10260, SRT, "Estimated")</i>
121428	<i>Calculated</i>	<i>Measurement obtained by calculation</i>	<i>Retired. Replaced with (R 41D2D, SRT, "Calculated")</i>
122001	Patient called to procedure room	Patient called to procedure room	
122002	Patient admitted to procedure room	Patient admitted to procedure room	
122003	Patient given pre-procedure instruction	Patient given pre-procedure instruction	
122004	Patient informed consent given	Patient informed consent given	
122005	Patient advance directive given	Patient advance directive given	
122006	Nil Per Os (NPO) status confirmed	Nil Per Os (NPO) status confirmed	
122007	Patient assisted to table	Patient assisted to table	
122008	Patient prepped and draped	Patient prepped and draped	
122009	Patient connected to continuous monitoring	Patient connected to continuous monitoring	
122010	Patient transferred to holding area	Patient transferred to holding area	
122011	Patient transferred to surgery	Patient transferred to surgery	
122012	Patient transferred to CCU	Patient transferred to CCU	
122020	Patient disoriented	Patient disoriented	
122021	Patient reports nausea	Patient reports nausea	
122022	Patient reports discomfort	Patient reports discomfort	

122023	Patient reports chest pain	Patient reports chest pain	
122024	Patient reports no pain	Patient reports no pain	
122025	Patient alert	Patient alert	
122026	Patient restless	Patient restless	
122027	Patient sedated	Patient sedated	
122028	Patient asleep	Patient asleep	
122029	Patient unresponsive	Patient unresponsive	
122030	Patient has respiratory difficulty	Patient has respiratory difficulty	
122031	Patient coughed	Patient coughed	
122032	Patient disconnected from continuous monitoring	Patient disconnected from continuous monitoring	
122033	Hemostasis achieved	Hemostasis achieved	
122034	Hemostasis not achieved – oozing	Hemostasis not achieved – oozing	
122035	Hemostasis not achieved – actively bleeding	Hemostasis not achieved – actively bleeding	
122036	Patient given post-procedure instruction	Patient given post-procedure instruction	
122037	Patient discharged	Patient discharged	
122038	Patient pronounced dead	Patient pronounced dead	
122039	Patient transferred to morgue	Patient transferred to morgue	
122041	Personnel Arrived	Identified personnel or staff arrived in procedure room	
122042	Personnel Departed	Identified personnel or staff departed procedure room	
122043	Page Sent To	Page sent to identified personnel or staff	
122044	Consultation With	Consultation with identified personnel or staff	
122045	Office called	Office of identified personnel or staff was called	
122046	Equipment failure	Equipment failure	
122047	Equipment brought to procedure room	Equipment brought to procedure room	
122048	Equipment ready	Equipment ready for procedure	
122049	Equipment removed	Equipment removed from procedure room	
122052	Bioptome	Device for obtaining biopsy sample	

122053	Valvular Intervention	Valvular Intervention	
122054	Aortic Intervention	Aortic Intervention	
122055	Septal Defect Intervention	Septal Defect Intervention	
122056	Vascular Intervention	Vascular Intervention	
122057	Myocardial biopsy	Myocardial biopsy	
122058	Arterial conduit angiography	Arterial conduit angiography	
122059	Single plane Angiography	Single plane Angiography	
122060	Bi-plane Angiography	Bi-plane Angiography	
122061	Percutaneous Coronary Intervention	Percutaneous Coronary Intervention	
122062	15-Lead ECG	15-Lead electrocardiography	
122072	Pre-procedure log	Log of events occurring prior to the current procedure	
122073	Current procedure evidence	Analysis or measurements for current procedure (purpose of reference to evidence document)	
122075	Prior report for current patient	Prior report for current patient	
122076	Consumable taken from inventory	Identifier of Consumable taken from inventory	
122077	Consumable returned to inventory	Identifier of Consumable returned to inventory	
122078	Remaining consumable disposed	Identifier of consumable whose remaining content has been disposed	
122079	Consumable unusable	Identifier of Consumable determined to be unusable	
122081	Drug start	Identifier of Drug whose administration has started	
122082	Drug end	Identifier of Drug whose administration has ended	
122083	Drug administered	Identifier of Drug administered as part of procedure	
122084	Contrast start	Identifier of Contrast agent whose administration has started	
122085	Contrast end	Identifier of Contrast agent whose administration has ended	
122086	Contrast administered	Identifier of Contrast agent administered	
122087	Infusate start	Identifier of Infusate whose administration has started	
122088	Infusate end	Identifier of Infusate whose administration has ended	

122089	Device crossed lesion	Action of a device traversing a vascular lesion	
122090	Intervention Action	Action of a clinical professional performed on a patient for therapeutic purpose	
122091	Volume administered	Volume of Drug, Contrast agent, or Infusate administered	
122092	Undiluted dose administered	Undiluted dose of Drug, Contrast agent, or Infusate administered	
122093	Concentration	Concentration of Drug, Contrast agent, or Infusate administered	
122094	Rate of administration	Rate of Drug, Contrast agent, or Infusate administration	
122095	Duration of administration	Duration of Drug, Contrast agent, or Infusate administration	
122096	Volume unadministered or discarded	Volume of Drug, Contrast agent, or Infusate unadministered or discarded	
122097	Catheter Curve	Numeric parameter of Curvature of Catheter	
122098	Transmit Frequency	Transmit Frequency	
122099	ST change from baseline	Measured change of patient electrocardiographic ST level relative to baseline measurement	
122101	Aneurysm on cited vessel	Anatomic term modifier indicating aneurysm on cited vessel is the subject of the finding	
122102	Graft to cited segment, proximal section	Anatomic term modifier indicating proximal section of graft to cited vessel is the subject of the finding	
122103	Graft to cited segment, mid section	Anatomic term modifier indicating mid section of graft to cited vessel is the subject of the finding	
122104	Graft to cited segment, distal section	Anatomic term modifier indicating distal section of graft to cited vessel is the subject of the finding	
122105	DateTime of Intervention	DateTime of Intervention	
122106	Duration of Intervention	Duration of Intervention	
122107	<i>Baseline Stenosis Measurement</i>	<i>Lesion stenosis measured prior to any interventional procedure</i>	<i>Retired. Replaced with (R 101BB, SRT, "Lumen Diameter Stenosis"), post-coordinated with (G-7293, SRT, "Baseline Phase")</i>

122108	<i>Post-Intervention Stenosis Measurement</i>	<i>Lesion stenosis measured after an interventional procedure</i>	<i>Retired. Replaced with (R 101BB, SRT, "Lumen Diameter Stenosis"), post-coordinated with (G-7298, SRT, "Post-intervention Phase")</i>
122109	Baseline TIMI Flow	Assessment of perfusion across a coronary lesion measured prior to any interventional procedure	
122110	Post-Intervention TIMI Flow	Assessment of perfusion across a coronary lesion measured after an interventional procedure	
122111	Primary Intervention Device	Indication that device is the primary (first and/or most significant) device used for interventional therapy of a particular pathology (e.g., lesion)	
122112	Normal Myocardium	Normal Myocardium	
122113	Scarred Myocardium	Scarred Myocardium	
122114	Thinning Myocardium	Thinning Myocardium	
122120	Hemodynamics Report	Hemodynamics Report	
122121	Atrial pressure measurements	Atrial pressure measurements, report section	
122122	Ventricular pressure measurements	Ventricular pressure measurements, report section	
122123	Gradient assessment	Gradient assessment, report section	
122124	Blood velocity measurements	Blood velocity measurements, report section	
122125	Blood lab measurements	Blood lab measurements, report section	
122126	Derived Hemodynamic Measurements	Derived Hemodynamic Measurements, report section	
122127	Clinical Context	Clinical Context, report section	
122128	Patient Transferred From	Location from which the patient was transferred	
122129	PCI during this procedure	Indication that the procedure includes a percutaneous coronary intervention	
122130	Dose Area Product	Radiation dose times area of exposure	
122131	Degree of Thrombus	Finding of probability and/or severity of thrombus	
122132	Severity of Calcification	Severity of Calcification, property of lesion	
122133	Lesion Morphology	Lesion Morphology; form and/or	

		structural properties of lesion	
122134	Vessel Morphology	Vessel Morphology; form and/or structural properties of vessel	
122138	Circulatory Support	Technique (device or procedure) of support for patient circulatory system; hemodynamic support	
122139	Reason for Exam	Reason for Exam	
122140	Comparison with Prior Exam Done	Indication that the current exam data has been compared with prior exam data	
122141	Electrode Placement	Electrocardiographic electrode placement technique	
122142	Acquisition Device Type	Acquisition Device Type	
122143	Acquisition Device ID	Acquisition Device ID	
122144	Quantitative Analysis	Quantitative Analysis, report section	
122145	Qualitative Analysis	Qualitative Analysis, report section	
122146	Procedure Datetime	The date and time on which a procedure was performed on a patient.	
122147	Clinical Interpretation	Clinical Interpretation, report section	
122148	Lead ID	ECG Lead Identifier	
122149	Beat Number	Beat Number; ordinal of cardiac cycle within an acquisition	
122150	Compound Statement	Complex coded semantic unit, consisting of several coded components	
122151	Trend	Trend (temporal progression) of a clinical condition, finding, or disease	
122152	Statement	Coded semantic unit	
122153	Statement Modifier	Coded modifier for a semantic unit	
122154	Conjunctive Term	Conjunctive term between semantic units	
122157	Probability	Probability	
122158	ECG Global Measurements	ECG Global Measurements, report section	
122159	ECG Lead Measurements	ECG Lead Measurements, report section	
122160	Derived Area, Non-Valve	Derived cross-sectional area of a vessel or anatomic feature, other than a cardiac valve	
122161	Pulmonary Flow	Rate of blood flow through	

		Pulmonary artery	
122162	Systemic Flow	Rate of blood flow through the aorta	
122163	Discharge DateTime	DateTime of patient discharge from hospital admission	
122164	Coronary Artery Bypass During This Admission	Indication that a Coronary Artery Bypass operation was performed during the current hospital admission	
122165	Date of Death	Date of Death	
122166	Death During This Admission	Indication that the patient died during the current hospital admission	
122167	Death During Catheterization	Indication that the patient died during the current Catheterization procedure	
122170	Type of Myocardial Infarction	Finding of type of Myocardial Infarction	
122171	Coronary lesion >= 50% stenosis	Finding of Coronary lesion with greater than 50% stenosis	
122172	Acute MI Present	Finding of Acute Myocardial Infarction Presence as indication for interventional procedure	
122173	ST Elevation Onset Datetime	Datetime of first determination of elevated ECG ST segment, as indication of Myocardial Infarction	
122175	Number of lesion interventions attempted	Number of lesion interventions attempted during current procedure	
122176	Number of lesion interventions successful	Number of lesion interventions successful during current procedure, where the residual post intervention stenosis is less than or equal to 50% of the arterial luminal diameter, TIMI Flow is 3 and the minimal decrease in stenosis was 20%.	
122177	Procedure Result	Overall success of interventional procedure	
122178	Lesion Intervention Information	Lesion Intervention Information, report section	
122179	Peri-procedural MI occurred	Indication that Myocardial Infarction occurred during current procedure	
122180	CK-MB baseline	Creatine Kinase-MB value at baseline (start of procedure)	
122181	CK-MB peak	Creatine Kinase-MB highest value measured during procedure	

122182	R-R interval	Time interval between ECG R-wave peaks in subsequent cardiac cycles	
122183	Blood temperature	Blood temperature	
122185	Blood Oxygen content	Blood Oxygen content	
122187	Blood Carbon dioxide saturation	Blood Carbon dioxide saturation	
122188	Pulmonary Arterial Content (FCpa)	Pulmonary Arterial Content (FCpa)	
122189	Pulmonary Venous Content (FCpv)	Pulmonary Venous Content (FCpv)	
122190	Max dp/dt/P	Max dp/dt/P	
122191	Ventricular End Diastolic pressure	Ventricular End Diastolic pressure	
122192	Indicator appearance time	Elapsed time from injection of an indicator bolus until it is observed at another location	
122193	Maximum pressure acceleration	Maximum pressure acceleration	
122194	Ventricular Systolic blood pressure	Ventricular Systolic blood pressure	
122195	Pulse Strength	Pulse Strength; palpable strength of systolic flow	
122196	C wave pressure	The secondary peak pressure in the atrium during atrial contraction	
122197	Gradient pressure, average	Gradient pressure, average	
122198	Gradient pressure, peak	Gradient pressure, peak	
122199	Pressure at dp/dt max	Pressure at dp/dt max	
122220	Hemodynamic Resistance Index	Hemodynamic Resistance Index	
122221	Thorax diameter, sagittal	Thorax diameter, sagittal	
122222	Procedure Environmental Characteristics	Environmental characteristics in the procedure room	
122223	Room oxygen concentration	Oxygen concentration in the procedure room	
122224	Room temperature	Temperature in the procedure room	
122225	Room Barometric pressure	Barometric pressure in the procedure room	
122227	Left to Right Flow	Left to Right Flow	



122228	Right to Left Flow	Right to Left Flow	
122229	Arteriovenous difference	Arteriovenous oxygen content difference	
122230	10 Year CHD Risk	Framingham Study 10 Year CHD Risk	
122231	Comparative Average 10 Year CHD Risk	Framingham Study Comparative Average 10 Year CHD Risk	
122232	Comparative Low 10 Year CHD Risk	Framingham Study Comparative Low 10 Year CHD Risk	
122233	LDL Cholesterol Score Sheet for Men	Framingham Study LDL Cholesterol Score Sheet for Men	
122234	LDL Cholesterol Score Sheet for Women	Framingham Study LDL Cholesterol Score Sheet for Women	
122235	Total Cholesterol Score Sheet for Men	Framingham Study Total Cholesterol Score Sheet for Men	
122236	Total Cholesterol Score Sheet for Women	Framingham Study Total Cholesterol Score Sheet for Women	
122237	Corrected Sinus Node Recovery Time	Corrected Sinus Node Recovery Time	
122238	Max volume normalized to 50mmHg pulse pressure	Max volume normalized to 50mmHg pulse pressure	
122239	Oxygen Consumption	Oxygen Consumption	
122240	BSA = $0.003207 \cdot WT^{(0.7285 - 0.0188 \log(WT))} \cdot HT^{0.3}$	Body Surface Area computed from patient height and weight: BSA = $0.003207 \cdot WT[kg]^{(0.7285 - 0.0188 \log(WT[kg]))} \cdot HT[cm]^{0.3}$	
122241	BSA = $0.007184 \cdot WT^{0.425} \cdot HT^{0.725}$	Body Surface Area computed from patient height and weight: BSA = $0.007184 \cdot WT[kg]^{0.425} \cdot HT[cm]^{0.725}$ [Dubois and Dubois, Proc Soc Exp Bio NY, 1916]	
122242	BSA = $0.0235 \cdot WT^{0.51456} \cdot HT^{0.42246}$	Body Surface Area computed from patient height and weight: BSA = $0.0235 \cdot WT[kg]^{0.51456} \cdot HT[cm]^{0.42246}$	
122243	BSA = $0.024265 \cdot WT^{0.5378} \cdot HT^{0.3964}$	Body Surface Area computed from patient height and weight: BSA = $0.024265 \cdot WT[kg]^{0.5378} \cdot HT[cm]^{0.3964}$	
122244	BSA = (HT *	Body Surface Area computed	

	$WT/36)^{0.5}$	from patient height and weight: $BSA = (HT[m] * WT[kg]/36)^{0.5}$	
122247	$VO2_{male} = BSA (138.1 - 11.49 * \log_e(\text{age}) + 0.378 * HR_f)$	Equation for estimated oxygen consumption: $VO2_{male} = BSA (138.1 - 11.49 * \log_e(\text{age}) + 0.378 * HR_f)$	
122248	$VO2_{female} = BSA (138.1 - 17.04 * \log_e(\text{age}) + 0.378 * HR_f)$	Equation for estimated oxygen consumption: $VO2_{female} = BSA (138.1 - 17.04 * \log_e(\text{age}) + 0.378 * HR_f)$	
122249	$VO2 = VeSTPD * 10 * (FIO_2 - FE_2)$	Equation for estimated oxygen consumption: $VO2 = VeSTPD * 10 * (FIO_2 - FE_2)$	
122250	$VO2 = 152 * BSA$	Equation for estimated oxygen consumption: $VO2 = 152 * BSA$	
122251	$VO2 = 175 * BSA$	Equation for estimated oxygen consumption: $VO2 = 175 * BSA$	
122252	$VO2 = 176 * BSA$	Equation for estimated oxygen consumption: $VO2 = 176 * BSA$	
122253	Robertson & Reid table	Robertson & Reid Table for estimated oxygen consumption	
122254	Fleisch table	Fleisch table for estimated oxygen consumption	
122255	Boothby table	Boothby table for estimated oxygen consumption	
122256	if (prem age < 3days) P50= 19.9	Estimate of Oxygen partial pressure at 50% saturation for premature infants less than 3 days old: P50= 19.9	
122257	if (age < 1day) P50= 21.6	Estimate of Oxygen partial pressure at 50% saturation for infants less than 1 day old: P50= 21.6	
122258	if (age < 30day) P50= 24.6	Estimate of Oxygen partial pressure at 50% saturation for infants less than 30 days old: P50= 24.6	
122259	if (age < 18y) P50= 27.2	Estimate of Oxygen partial pressure at 50% saturation for patients less than 18 years old: P50= 27.2	
122260	if (age < 40y) P50= 27.4	Estimate of Oxygen partial pressure at 50% saturation for patients less than 40 years old: P50= 27.4	
122261	if (age > 60y) P50= 29.3	Estimate of Oxygen partial pressure at 50% saturation for patients more than 60 years old: P50= 29.3	
122262	$\text{Area} = \text{Flow} / 44.5 *$	Cardiac valve area computed	

	$\sqrt{\text{Gradient}[\text{mmHg}]}$ )	from flow and pressure gradient: Area = Flow / 44.5 * $\sqrt{\text{Gradient}[\text{mmHg}]}$ [Gorlin and Gorlin, Am Heart J, 1951]	
122263	MVA = Flow / 38.0 * $\sqrt{\text{Gradient}[\text{mmHg}]}$ )	Mitral valve area computed from flow and pressure gradient: Mitral valve Area = Flow / 38.0 * $\sqrt{\text{Gradient}[\text{mmHg}]}$ [Gorlin and Gorlin, Am Heart J, 1951]	
122265	BMI = Wt/Ht <sup>2</sup>	Body Mass Index computed from weight and height: BMI = Wt/Ht <sup>2</sup>	
122271	Skin Condition Warm	Skin Condition Warm	
122272	Skin Condition Cool	Skin Condition Cool	
122273	Skin Condition Cold	Skin Condition Cold	
122274	Skin Condition Dry	Skin Condition Dry	
122275	Skin Condition Clammy	Skin Condition Clammy	
122276	Skin Condition Diaphoretic	Skin Condition Diaphoretic	
122277	Skin Condition Flush	Skin Condition Flush	
122278	Skin Condition Mottled	Skin Condition Mottled	
122279	Skin Condition Pale	Skin Condition Pale	
122281	Airway unobstructed	Airway unobstructed	
122282	Airway partially obstructed	Airway partially obstructed	
122283	Airway severely obstructed	Airway severely obstructed	
122288	Not Visualized	Anatomy could not be visualized for the purpose of evaluation	
122291	Quantitative Arteriography Report	Quantitative Arteriography Report	
122292	Quantitative Ventriculography Report	Quantitative Ventriculography Report	
122301	Guidewire crossing lesion unsuccessful	Guidewire crossing lesion unsuccessful	
122302	Guidewire crossing lesion successful	Guidewire crossing lesion successful	
122303	Angioplasty balloon inflated	Angioplasty balloon inflated	
122304	Angioplasty balloon deflated	Angioplasty balloon deflated	
122305	Device deployed	Device deployed	
122306	Stent re-expanded	Stent re-expanded	
122307	Object removed	Object removed	

122308	Radiation applied	Radiation applied	
122309	Radiation removed	Radiation removed	
122310	Interventional device placement unsuccessful	Interventional device placement unsuccessful	
122311	Interventional device placed	Interventional device placed	
122312	Intervention performed	Intervention performed	
122313	Interventional device withdrawn	Interventional device withdrawn	
122319	Catheter Size	Catheter Size	
122320	Injectate Temperature	Injectate Temperature	
122321	Injectate Volume	Injectate Volume	
122322	Calibration Factor	Factor by which a measured or calculated value is multiplied to obtain the estimated real-world value.	
122325	IVUS Report	Intravascular Ultrasound Report	
122330	EEM Diameter	External Elastic Membrane (EEM) diameter measured through the center point of the vessel. Center point of the vessel is defined as the center of gravity of the EEM area. The EEM is a discrete interface at the border between the media and the adventitia.	
122331	Plaque Plus Media Thickness	The distance from intimal leading edge to the external elastic membrane along any line passing through the luminal center, which is defined as the center of gravity of the lumen area.	
122332	Lumen Perimeter	Planimetered perimeter of the lumen.	
122333	EEM Cross-Sectional Area	Vessel area measured at the External Elastic Membrane (EEM), a discrete interface at the border between the media and the adventitia.	
122334	Plaque plus Media Cross-Sectional Area	Area within the EEM occupied by atheroma, regardless of lumen compromise. Plaque plus Media Area = EEM cross-sectional area - vessel lumen cross-sectional area	
122335	In-Stent Neointimal	Measurement of in-stent	

	Cross-Sectional Area	restenosis. In-Stent Intimal Area = Stent cross-sectional area – vessel lumen cross-sectional area	
122336	Vascular Volume measurement length	Longitudinal extent of the Vascular Volume Measurement. This is the distance from the distal edge to the proximal edge of the Volume measurement.	
122337	Relative position	Longitudinal distance from the closest edge of a fiducial feature or reference location to the start of the vascular measurement. This value will be a positive if the measurement is distal to the fiducial feature or reference location, or negative if the measurement is proximal to the fiducial feature or reference location.	
122339	Stent Volume Obstruction	In-Stent Neointimal Volume / Stent Volume	
122340	Fiducial feature	Reference, normally anatomical, which is used for locating the position of a measurement.	
122341	Calcium Length	Longitudinal calcium length measurement	
122343	Lumen Eccentricity Index	Measurement of vessel lumen eccentricity. Lumen Eccentricity Index = (maximum vessel lumen diameter - minimum vessel lumen diameter) / maximum vessel lumen diameter. Lumen diameters are measured through the center point of the lumen, which is defined as the center of gravity of the lumen area.	
122344	Plaque plus Media Eccentricity Index	Plaque plus Media Eccentricity Index = (maximum Plaque plus media thickness - minimum Plaque plus media thickness) / maximum Plaque plus media thickness	
122345	Remodeling Index	Measurement of increase or decrease in EEM area that occurs during the development of atherosclerosis. Remodeling Index = Lesion EEM area / reference EEM area	
122346	Stent Symmetry Index	Measurement of stent circularity. Stent Symmetry Index = (maximum stent diameter - minimum stent diameter) /	

		maximum stent diameter	
122347	Stent Expansion Index	Measurement of stent area relative to the reference lumen area. Stent Expansion Index = Minimum stent area / reference vessel lumen cross-sectional area	
122348	Lumen Shape Index	Measurement of vessel lumen eccentricity. Lumen Shape Index = $(2\pi * \sqrt{\text{Vessel lumen cross-sectional area} / \pi}) / \text{Lumen Perimeter}$ 2 Reference: Tobis & Yock, "Intravascular Ultrasound Imaging", Chapter 7	
122350	Lumen Diameter Ratio	Lumen diameter ratio = minimum vessel lumen diameter / maximum vessel lumen diameter, measured at the same cross section in the vessel. Lumen diameters are measured through the center point of the lumen, which is defined as the center of gravity of the lumen area.	
122351	Stent Diameter Ratio	Stent diameter ratio = Minimum stent diameter / Maximum stent diameter, measured at the same cross section in the vessel. Stent diameters are measured through the center point of the stent, which is defined as the center of gravity of the stent area.	
122352	EEM Diameter Ratio	EEM diameter ratio = minimum EEM diameter / maximum EEM diameter. Measured at the same cross section in the vessel.	
122354	Plaque Burden	Fractional area within the External Elastic Membrane (EEM) occupied by atheroma. Plaque Burden = $(\text{EEM area} - \text{vessel lumen cross-sectional area}) / \text{EEM area}$	
122355	Arc of Calcium	Angular measurement of a Calcium deposit with the apex located at the center of the lumen, which is defined as the center of gravity of the lumen area.	
122356	Soft plaque	Plaque characterized by low density or echogenicity.	
122357	In-Stent Neointima	Abnormal thickening of the intima within the stented	

		segment.	
122360	True Lumen	Lumen surrounded by all three layers of the vessel-intima, media, and adventitia.	
122361	False Lumen	A channel, usually parallel to the true lumen, which does not communicate with the true lumen over a portion of its length.	
122363	Plaque Rupture	Plaque ulceration with a tear detected in a fibrous cap.	
122364	Stent Gap	Length of gap between two consecutive stents.	
122367	T-1 Worst	Worst stenosis - the stenosis with the smallest lumen size within a vessel segment.	
122368	T-2 Secondary	2nd most severe stenosis within a vessel segment.	
122369	T-3 Secondary	3rd most severe stenosis within a vessel segment.	
122370	T-4 Secondary	4th most severe stenosis within a vessel segment.	
122371	EEM Volume	External Elastic Membrane (EEM) volume measured within a specified region. The EEM is a discrete interface at the border between the media and the Adventitia.	
122372	Lumen Volume	Lumen volume measured within a specified region.	
122374	In-Stent Neointimal Volume	The amount of plaque between the lumen and stent, within the stent region; In-stent restenosis. In-Stent Neointimal Volume = Stent Volume - Lumen Volume	
122375	Native Plaque Volume	The amount of plaque between the stent and the EEM, within the stent region. Native Plaque Volume = EEM Volume - Stent Volume	
122376	Total Plaque Volume	Total amount of plaque between the EEM and the Lumen, over the entire region that is measured. Total Plaque Volume = EEM Volume - Lumen Volume.	
122380	Proximal Reference	Proximal reference segment measurement site. Typically the site with the largest lumen proximal to a stenosis but within the same segment (usually	

		within 10 mm of the stenosis with no major intervening branches).	
122381	Distal Reference	Distal reference segment measurement site. Typically the site with the largest lumen distal to a stenosis but within the same segment (usually within 10 mm of the stenosis with no major intervening branches).	
122382	Site of Lumen Minimum	Site of the smallest lumen in a vessel, e.g., due to a stenotic lesion.	
122383	Entire Pullback	Measurement region that encompasses the entire vessel imaged in a single pullback acquisition	
122384	Stented Region	Measurement region occupied by the stent	
122385	Proximal Stent Margin	Region starting at the proximal edge of the Stent and extending several millimeters (usually 5 mm) proximal to the Stent edge.	
122386	Distal Stent Margin	Region starting at the distal edge of the Stent and extending several millimeters (usually 5 mm) distal to the Stent edge.	
122387	Dissection Classification	Classification of dissections in a vessel	
122388	Intra-stent Dissection	Separation of neointimal hyperplasia from stent struts, usually seen only after treatment of in-stent restenosis.	
122389	Vulnerable Plaque	Plaque with a thin cap fibrous atheroma that is at increased risk of rupture and thrombosis (or re-thrombosis) and rapid stenosis progression.	
122390	Eroded Plaque	Plaque erosions with no structural defect (beyond endothelial injury) or gap in the plaque.	
122391	Relative Stenosis Severity	Stenosis severity classifications of multiple lesions in a vessel.	
122393	Restenotic Lesion	A finding of a previously treated lesion in which stenosis has reoccurred.	
122394	Fibro-Lipidic Plaque	Loosely packed bundles of collagen fibers with regions of lipid deposition present. Region is cellular and no cholesterol clefts or necrosis are present.	



		Some macrophage infiltration. Increase in extra cellular matrix.	
122395	Necrotic-Lipidic Plaque	Area within the plaque with very low echogenicity separated from the lumen and surrounded by more echogenic structures (fibrous cap). Highly lipidic necrotic region with remnants of foam cells and dead lymphocytes present. No collagen fibers are visible and mechanical integrity is poor. Cholesterol clefts and micro calcifications are visible.	
122398	Intimal Dissection	Dissection limited to the intima or atheroma, and not extending to the media.	
122399	Medial Dissection	Dissection in the arterial Media, extending into the media.	
122400	Simultaneously Acquired	The referenced information was acquired simultaneously with the information in the object in which the reference occurs.	
122401	Same Anatomy	Information acquired for the same anatomic region.	
122402	Same Indication	Information acquired for the same indication (e.g. to elucidate the same diagnostic question).	
122403	For Attenuation Correction	The referenced information was used to correct the data for differential attenuation through different anatomic tissue.	
122404	Reconstructed	Value estimated for a vessel in the absence of a stenosis	
122405	Algorithm Manufacturer	Manufacturer of application used	
122406	Left Atrial Ejection Fraction by Angiography	Left Atrial Ejection Fraction by Angiography	
122407	Left Atrial ED Volume	Left Atrial End Diastolic Volume	
122408	Left Atrial ES Volume	Left Atrial End Systolic Volume	
122410	Contour Realignment	Contour repositioning of End Diastolic relative to End Systolic contour	
122411	Threshold Value	The minimum standard deviation to define the hypokinesis and hyperkinesis	
122417	Regional Abnormal Wall Motion	Report of differentiation of wall motion compared to normal	

122421	Calibration Object	Object used for Calibration	
122422	Calibration Method	Method used for Calibration	
122423	Calibration Object Size	Size of calibration object	
122428	Area Length Method	Method how long axis is positioned	
122429	Volume Method	Model for ventricular volume calculation	
122430	Reference Method	Method to define original diameter of the artery	
122431	Regression Slope ED	Relation between calculated End Diastolic volume and ventricular End Diastolic volume. The specific meaning is dependent on volume method used.	
122432	Regression Offset ED	Correction factor for the calculated End Diastolic volume and ventricular End Diastolic volume. The specific meaning is dependent on volume method used.	
122433	Regression Slope ES	Relation between calculated End Systolic volume and ventricular End Systolic volume. The specific meaning is dependent on volume method used.	
122434	Regression Offset ES	Correction factor for the calculated End Systolic volume and ventricular End Systolic volume. The specific meaning is dependent on volume method used.	
122435	Regression Volume Exponent	Exponent of volume in regression formula	
122438	Reference Points	Container for spatial locations or coordinates used for calculation	
122445	Wall Thickness	Average thickness of the chamber wall in the current view	
122446	Wall Volume	Volume of the chamber wall estimated from the current view	
122447	Wall Mass	Mass of the chamber wall (myocardium)	
122448	Wall Stress	Peak systolic stress of chamber wall	
122449	Centerline Wall Motion Analysis	Method to calculate wall motion [example: Sheehan, 1986]	
122450	Normalized Chord Length	The length between End Diastolic and End Systolic contour perpendicular on the centerline normalized by a	

		method dependent ventricular perimeter length. The centerline is the line equidistant between the End Diastolic and End Systolic contour [example: Sheehan, 1986]	
122451	Abnormal Region	The report of the boundaries of the abnormal (hyperkinetic, hypokinetic, a-kinetic) regions associated with the territory of the artery [example: Sheehan, 1986]	
122452	First Chord of Abnormal Region	The chord number specifying the begin of abnormal region [example: Sheehan, 1986]	
122453	Last Chord of Abnormal Region	The chord number specifying the end of abnormal region [example: Sheehan, 1986]	
122459	Territory Region Severity	Severity at the regional abnormality extent [example: Sheehan, 1986]	
122461	Opposite Region Severity	Severity at the opposite regional abnormality extent [example: Sheehan, 1986]	
122464	LAD Region in RAO Projection	Based on a total number of chords of 100 and RAO project the range of chords belonging to this circumferential extent lies between 5 – 85. [Sheehan, 1986]	
122465	RCA Region in ROA Projection	Based on a total number of chords of 100 and RAO project the range of chords belonging to this circumferential extent lies between 25 – 85. [Sheehan, 1986]	
122466	Single LAD Region in RAO Projection	Based on a total number of chords of 100 and RAO projection the range of chords belonging to this regional extent lies between 10 – 66 (hypokinetic) and 67 – 80 (hyperkinetic). [Sheehan, 1986]	
122467	Single RCA Region in RAO Projection	Based on a total number of chords of 100 and RAO projection the range of chords belonging to this regional extent lies between 51 – 80 (hypokinetic) and 10 – 50 (hyperkinetic). [Sheehan, 1986]	
122468	Multiple LAD Region in RAO Projection	Based on a total number of chords of 100 and RAO projection the range of chords	

		belonging to this regional extent lies between 10 – 58 (hypokinetic) and 59 –80 (hyperkinetic). [Sheehan, 1986]	
122469	Multiple RCA Region in RAO Projection	Based on a total number of chords of 100 and RAO projection the range of chords belonging to this regional extent lies between 59 – 80 (hypokinetic) and 10 – 58 (hyperkinetic). [Sheehan, 1986]	
122470	LAD Region in LAO Projection	Based on a total number of chords of 100 and LAO projection the range of chords belonging to this regional extent lies between 50 –100 (hypokinetic) and 20 – 49 (hyperkinetic). [Sheehan, 1986]	
122471	RCA Region in LAO Projection	Based on a total number of chords of 100 and LAO projection the range of chords belonging to this regional extent lies between 19 – 67 (hypokinetic) and 68 – 100 (hyperkinetic). [Sheehan, 1986]	
122472	CFX Region in LAO Projection	Based on a total number of chords of 100 and LAO projection the range of chords belonging to this regional extent lies between 38 –74 (hypokinetic) and 75 – 100 (hyperkinetic). [Sheehan, 1986]	
122473	Circular Method	Method based on assumption that the image object is circular.	
122474	Densitometric Method	Method based on the gray value distribution of the image.	
122475	Center of Gravity	End Systolic contour realigned to End Diastolic contour based on the center of gravity	
122476	Long Axis Based	End Systolic contour realigned to End Diastolic contour based on the mid point of the long axis. The long axis end points are defined as the posterior and apex.	
122477	No Realignment	No Contour Realignment applied	
122480	Vessel Lumen Cross-Sectional Area	Calculated Vessel Lumen Cross-Sectional Area based on the referenced method	
122481	Contour Start	Location of the beginning of a contour	
122482	Contour End	Location of the end of a contour	

122485	Sphere	Sphere is used as calibration object	
122486	Geometric Isocenter	Object of interest in isocenter of image and pixel separation is calculated from geometric data	
122487	Geometric Non-Isocenter	Object of interest not in isocenter of image and pixel separation is calculated from geometric data and out of isocenter distances	
122488	Calibration Object Used	Object used for calibration (e.g. sphere)	
122489	Curve Fitted Reference	Application dependent method to calculate the reference diameter based on the multiple diameter values.	
122490	Interpolated Local Reference	Application dependent method to calculate reference by interpolation, based on the diameter of two or more user defined reference positions.	
122491	Mean Local Reference	Application dependent method to calculate by averaging the reference, based on the diameter of one or more user defined reference positions.	
122493	Radial Based Wall Motion Analysis	Method to calculate wall motion based on the lengths of the radials in the predefined regions [Ingels]	
122495	Regional Contribution to Ejection Fraction	Contribution of Region to global Ejection factor based on radial or landmark based wall motion method	
122496	Radial Shortening	The reduction of area between End Systolic and End Diastolic based on radial wall motion analysis	
122497	Landmark Based Wall Motion Analysis	Method to calculate wall motion based on the move of landmarks on the wall [Slager]	
122498	Slice Contribution to Ejection Fraction	Contribution to the ejection fraction of a specific slice region [Slager]	
122499	Frame to Frame Analysis	Method to calculate volumes of heart chambers for every image in a range	
122505	Calibration	Procedure used to calibrate measurements or measurement devices	
122507	Left Contour	Left contour of lumen (direction proximal to distal)	

122508	Right Contour	Right contour of lumen (direction proximal to distal)	
122509	Diameter Graph	Ordered set of diameters values derived from contours (direction proximal to distal)	
122510	Length Luminal Segment	Length Luminal Segment	
122511	Graph Increment	Increment value along X-axis in Diameter Graph	
122516	Site of Maximum Luminal	Location of the maximum lumen area in a lesion or vessel.	
122517	Densitometric Luminal Cross-sectional Area Graph	Ordered set of cross-sectional Vessel Lumen Cross-Sectional Area values derived from contours (direction proximal to distal) based on densitometric method	
122528	Position of Proximal Border	Position of proximal border of segment relative to the contour start (proximal end of analysis area)	
122529	Position of Distal Border	Position of distal border of segment relative to the contour start (proximal end of analysis area)	
122542	Plaque Area	Longitudinal cross sectional area of plaque	
122544	Diameter Symmetry	Symmetry of stenosis (0 = complete asymmetry, 1 = complete symmetry) [reference PS 3.17 X.2]	
122545	Area Symmetry	Symmetry of plaque (0 = complete asymmetry, 1 = complete symmetry) [reference PS 3.17 X.2]	
122546	Inflow Angle	The average slope of the diameter function between the position of the minimum luminal diameter and the position of the proximal border of the segment	
122547	Outflow Angle	The average slope of the diameter function between the position of the minimum luminal diameter and the position of the distal border of the segment	
122548	Stenotic Flow Reserve	The relation between coronary pressure and coronary flow	
122549	Poiseuille Resistance	Poiseuille Resistance at the location of the stenosis	
122550	Turbulence	Turbulence Resistance at the	

	Resistance	location of the stenosis	
122551	Pressure Drop at SFR	Pressure drop over the stenosis at maximum heart output	
122554	Segmentation Method	Method for selection of vessel sub-segments	
122555	Estimated Normal Flow	Estimate of the volume of blood flow in the absence of stenosis	
122558	Area Length Kennedy	Area Length method defined by Kennedy [Kennedy, 1970]	
122559	Area Length Dodge	Area Length method defined by Dodge [Dodge, 1960]	
122560	Area Length Wynne	Area Length method defined by Wynne [Wynne]	
122562	Multiple Slices	Volume method based on multiple slice	
122563	Boak	Volume method defined by Boak [Boak]	
122564	TS Pyramid	Volume method defined by Ferlinz [Ferlinz]	
122565	Two Chamber	Volume method defined by Graham [Graham]	
122566	Parallelepiped	Volume method defined by Arcilla [Arcilla]	
122572	BSA <sup>1.219</sup>	Corrected Body Surface area for indexing the hemodynamic measurements for a pediatric patient	
122574	Equidistant method	Method for selecting sub-segments that are all of the same length	
122575	User selected method	Manually selected start and end of sub-segment	
122582	Left ventricular posterobasal segment	Left ventricular posterobasal segment	
122600	Cardiovascular Analysis Report	Report of a Cardiovascular Analysis, typically from a CT or MR study	
122601	Ventricular Analysis	Ventricular Analysis	
122602	Myocardial Perfusion Analysis	Myocardial Perfusion Analysis	
122603	Calcium Scoring Analysis	Calcium Scoring Analysis	
122604	Flow Quantification	Flow Quantification Analysis	
122605	Vascular Morphological Analysis	Vascular Morphological Analysis	
122606	Vascular Functional	Vascular Functional Analysis	

	Analysis		
122607	Thickening Analysis	Analysis of myocardial wall thickening	
122608	Absolute Values Of Ventricular Measurements	Section Heading for absolute values of ventricular measurements	
122609	Normalized Values Of Ventricular Measurements	Results of normalizing ventricular measurements	
122611	Reference Point	Reference Point of a measurement	
122612	Central breathing position	Central breathing position between inspiration and expiration	
122616	Peak Ejection Rate	Peak of the ventricular ejection rate	
122617	Peak Ejection Time	Time of the peak of ventricular ejection	
122618	Peak Filling Rate	Peak of the fluid filling rate	
122619	Peak Filling Time	Time interval from a given reference point (e.g. end systole) until time of peak filling	
122620	Papillary Muscle Excluded	Papillary muscle was excluded from the measurement	
122621	Papillary Muscle Included	Papillary muscle was included in the measurement	
122624	Wall Thickness Ratio end-systolic to end-diastolic	The ratio of the end-systolic wall thickness compared to the end-diastolic wall thickness	
122627	Curve Fit Method	The method to smooth a ventricular volume as a function of time	
122628	Baseline Result Correction	Baseline correction used in the calculation of the results	
122631	Signal Earliest Peak Time	The time in a dynamic set of images at which the first peak of the signal is observed for the analysed myocardial wall segments.	
122633	Signal Increase Start Time	This is the time at which the signal begins to increase.	
122634	Signal Time to Peak	Time interval between the beginning of the signal increase to the time at which the signal intensity reaches its first maximum in a dynamic set of images.	
122635	MR Perfusion Peak	Peak of the MR perfusion signal	
122636	MR Perfusion Slope	Signal intensity as a function of	



		time. It is the change in the signal intensity divided by the change in the time.	
122637	MR Perfusion Time Integral	MR perfusion time integral from baseline (foot time) to earliest peak	
122638	Signal Baseline Start	First time point in a dynamic set of images used in the calculation of the baseline signal intensity for each myocardial wall segment.	
122639	Signal Baseline End	Last time point in a dynamic set of images used in the calculation of the baseline signal intensity for each myocardial wall segment.	
122640	Image Interval	The time delta between images in a dynamic set of images.	
122642	Velocity Encoding Minimum Value	The minimum velocity encoded by the phase encoding gradient	
122643	Velocity Encoding Maximum Value	The maximum velocity encoded by the phase encoding gradient	
122645	Net Forward Volume	Forward volume-reverse volume	
122650	Area Based Method	Area Based Method for estimating volume or area	
122651	Diameter Based Method	Diameter Based Method for estimating volume, area or diameter	
122652	Volume Based Method	Volume Based Method for estimating volume	
122655	NASCET	A method of diameter measurements according to NASCET (North American Symptomatic Carotid Endarterectomy Trial)	
122656	ECST	A method of diameter measurements according to ECST (European Carotid Surgery Trial)	
122657	Agatston Score Threshold	Agatston Score Threshold	
122658	Calcium Mass Threshold	Calcium Mass Threshold	
122659	Calcium Scoring Calibration	Calcium Scoring Calibration	
122660	Calcium Volume	Calcium Volume	
122661	Calcium Mass	Calcium Mass	
122664	Late Contrast Enhancement	Delayed hyperenhancement of a tissue observed in an image acquired after injection of	

		contrast media.	
122665	Time interval since injection of contrast media	Time interval since injection of contrast media	
122666	Time relative to R-wave peak	Time relative to R-wave peak	
122667	Blood velocity vs. time of cardiac cycle	Relationship between blood velocity and time relative to R-wave peak	
122668	Time interval since detection of contrast bolus	Time interval since detection of contrast bolus	
122670	Papillary Muscle Included/Excluded	Indicates if the papillary muscle was included or excluded in the measurement	
122675	Anterior-Posterior	Anterior to Posterior direction	
122680	endoleak	Persistent flow of blood into the stent-grafting	
122683	Stent Fracture	Fracture of a stent	
122684	Stent Disintegration	Disintegration of a stent	
122685	Stent Composition	Material that a stent consists of	
122686	Parent Vessel Finding	Finding about the characteristics of the parent vessel of a vessel	
122687	Site of Lumen Maximum	Site of Maximal lumen diameter of a vessel	
122698	X-Concept	The physical domain (time, space, etc.) to the horizontal axis of the graphical presentation.	
122699	Y-Concept	The physical domain (time, space, etc.) to the vertical axis of the graphical presentation.	
123001	Radiopharmaceutical	Active ingredient (molecular) used for radioactive tracing	
123003	Radiopharmaceutical Start Time	Time of radiopharmaceutical administration to the patient for imaging purposes	
123004	Radiopharmaceutical Stop Time	Ending time of radiopharmaceutical administration to the patient for imaging purposes	
123005	Radiopharmaceutical Volume	Volume of radiopharmaceutical administered to the patient	
123006	Radionuclide Total Dose	Total amount of radionuclide administered to the patient at Radiopharmaceutical Start Time	
123007	Radiopharmaceutical Specific Activity	Activity per unit mass of the radiopharmaceutical at Radiopharmaceutical Start Time	

123009	Radionuclide Syringe Counts	Pre-injection syringe acquisition count rate	
123010	Radionuclide Residual Syringe Counts	Syringe acquisition count rate following patient injection	
123011	Contrast/Bolus Agent	Contrast or bolus agent	
123012	Pre-Medication	Medication to be administered at the beginning of the Scheduled Procedure Step	
123014	Target Region	Anatomic Region to be imaged	
123015	Imaging Direction	Direction of imaging (includes view, transducer orientation, patient orientation, and/or projection)	
123016	Imaging Conditions	Imaging condition for refinement of protocol (includes secondary posture, instruction, X-ray / electron beam energy or nuclide, and ultrasound modes), as used in JJ1017 v3.0	
125000	OB-GYN Ultrasound Procedure Report	Document Title of OB-GYN procedure report	
125001	Fetal Biometry Ratios	Report section for assessment of fetal growth using ratios and indexes	
125002	Fetal Biometry	Report section for assessment of fetal growth	
125003	Fetal Long Bones	Report section for assessment of fetal growth by long bone measurements	
125004	Fetal Cranium	Report section for assessment of fetal cranium growth	
125005	Biometry Group	Biometric assessment of	
125006	Biophysical Profile	Report section for assessment of biophysical observations that evaluate fetal well-being according to Manning, Antepartum Fetal Evaluation: Development of a Fetal Bbiophysical Profile Score, Am. J Obsetet Gynecol, 1980;136:787.	
125007	Measurement Group	A grouping of related measurements and calculations that share a common context	
125008	Fetus Summary	Report section for fetus specific prodedure summary observations	
125009	Early Gestation	Report section for assessment of early gestation fetus	

125010	Identifier	A name to differentiate between multiple instances of some item	
125011	Pelvis and Uterus	Report section for assessment of pelvis and uterus	
125012	Growth Percentile rank	The rank of a measured growth indicator relative to a normal distribution expressed as a percentage.	
125013	Growth Z-score	The rank of a measured growth indicator relative to a normal distribution expressed as the dimensionless quantity $z = (x - m)/s$ where $(x - m)$ is the deviation of the value $x$ , from the distribution mean, $m$ , and $s$ is the standard deviation of the distribution.	
125021	Frame of Reference Identity	There is a defined equivalence between the Frame of Reference of the Registration SOP instance and the Frame of Reference of the referenced images.	
125022	Fiducial Alignment	The registration is based on fiducials that represent patient or specimen features identified in each data set.	
125023	Acquisition Equipment Alignment	Registration based on a-priori knowledge of the acquisition geometry. This is not an object registration as in fiducial registration. Rather, it specifies a known spatial relationship.	
125024	Image Content-based Alignment	Computed registration based on global image information	
125025	Visual Alignment	Registration by visually guided manipulation.	
125030	Inter-Hemispheric Plane	A plane fiducial that specifies the location of the plane separating the two hemispheres of the brain.	
125031	Right Hemisphere Most Anterior	A point fiducial that specifies the location in the plane perpendicular to the Anterior-Posterior-Commissure axis and tangential to the anterior limit of the right brain hemisphere	
125032	Right Hemisphere Most Posterior	A point fiducial that specifies the location in the plane perpendicular to the Anterior-Posterior-Commissure axis and tangential to the posterior limit of	

		the right brain hemisphere	
125033	Right Hemisphere Most Superior	A point fiducial that specifies the location in the plane perpendicular to the Anterior-Posterior-Commissure axis and tangential to the superior limit of the right brain hemisphere	
125034	Right Hemisphere Most Inferior	A point fiducial that specifies the location in the plane perpendicular to the Anterior-Posterior-Commissure axis and tangential to the inferior limit of the Right brain hemisphere	
125035	Left Hemisphere Most Anterior	A point fiducial that specifies the location in the plane perpendicular to the Anterior-Posterior-Commissure axis and tangential to the anterior limit of the left brain hemisphere	
125036	Left Hemisphere Most Posterior	A point fiducial that specifies the location in the plane perpendicular to the Anterior-Posterior-Commissure axis and tangential to the posterior limit of the left brain hemisphere	
125037	Left Hemisphere Most Superior	A point fiducial that specifies the location in the plane perpendicular to the Anterior-Posterior-Commissure axis and tangential to the superior limit of the left brain hemisphere	
125038	Left Hemisphere Most Inferior	A point fiducial that specifies the location in the plane perpendicular to the Anterior-Posterior-Commissure axis and tangential to the inferior limit of the left brain hemisphere	
125100	Vascular Ultrasound Procedure Report	Root Document Title for ultrasound vascular evidence reports (worksheets).	
125101	Vessel Branch	The particular vessel branch, such as the inferior, medial or lateral	
125102	Graft Type	A descriptor or elaboration of the type of graft	
125200	Adult Echocardiography Procedure Report	Document title of adult echocardiography procedure (evidence) report.	
125201	Illustration of Finding	An image that is a pictorial representation of findings. The concept is typically used as a purpose of reference to an	

		image, such as a depiction of myocardium segments depicting wall motion function.	
125202	LV Wall Motion Score Index	The average of all scored (non-zero) Left Ventricle segment wall motion scores.	
125203	Acquisition Protocol	A type of clinical acquisition protocol for creating images or image-derived measurements. Acquisition protocols may be specific to a manufacturer's product.	
125204	Area-length biplane	Method for calculating left ventricular volume from two orthogonal views containing the true long axis (usually the apical 4 and 2 chamber views). Volume = $[\pi L_1/6] * [(4A_1) \div (\pi L_1)] * [(4A_2) \div (\pi L_2)]$	
125205	Area-Length Single Plane	Method for calculating left ventricular volume from a view containing the true long axis (usually the apical 4-chamber view). Volume = $[8(A)^2] \div [3\pi L]$	
125206	Cube	Method (formula) for calculating left ventricle volumes and function derivatives (EF, SV, SI, etc.) that estimates the volume as the cube of diameter.	
125207	Method of Disks, Biplane	Method of calculating volume based on the summation of disk volumes. The disk axis is parallel to the left ventricular long axis and using a disk diameter averaged from the two chamber and four chamber views.	
125208	Method of Disks, Single Plane	Method of calculating volume based on the summation of disk volumes. The disk axis is parallel to the left ventricular long axis with disk diameter taken from the four-chamber view.	
125209	Teichholz	Method (formula) for calculating left ventricle volumes and function derivatives (EF, SV, SI, etc.) Volume = $[7.0/(2.4+D)] * D^3$	
125210	Area by Pressure Half-Time	Mitral valve area (cm <sup>2</sup> ) by Pressure Half-time = 220 (cm <sup>2</sup> .ms) / PHT (ms)	
125211	Biplane Ellipse	Area = $\pi/4 \times d1 \times d2$ d1 = anterior/posterior axis d2 = medial/lateral axis	

		<i>Hagen-Ansert, Sandra L., Textbook of Diagnostic Ultrasound, ed. 3, The C.V.Mosby Co., 1989, p. 73.</i>	
125212	Continuity Equation	For conduits in series (“in continuity”), volume flow is equal: $A_1 \cdot V_1 = A_2 \cdot V_2$ . where V is the velocity	
125213	Continuity Equation by Mean Velocity	For conduits in series (“in continuity”), volume flow is equal: $A_1 \cdot V_1 = A_2 \cdot V_2$ . where V is the mean velocity	
125214	Continuity Equation by Peak Velocity	For conduits in series (“in continuity”), volume flow is equal: $A_1 \cdot V_1 = A_2 \cdot V_2$ . where V is the peak velocity	
125215	Continuity Equation by Velocity Time Integral	For conduits in series (“in continuity”), volume flow is equal: $A_1 \cdot V_1 = A_2 \cdot V_2$ . where V is the velocity time integral	
125216	Proximal Isovelocity Surface Area	Utilizes aliasing velocity (by color Doppler) of flow into an orifice (often regurgitant or stenotic) to measure instantaneous flow rate, orifice area, and flow volume.  The instantaneous flow rate = $(2 \pi r^2 v_{av}) \cdot (\alpha / \pi)$ where $v_{av}$ is the constant velocity known as aliasing velocity at radius $r$ , $v_p$ is the peak velocity at the orifice, and $\alpha$ is the angle in radians of the constant velocity surface.  Estimated Orifice area = Flow rate / $v_p$ , where $v_p$ is the peak velocity at the orifice and the flow rate is the PISA peak flow rate.  The volume flow is then the product of the orifice area and Velocity Time Integral	
125217	Full Bernoulli	$\Delta P = 4 \cdot (V_1^2 - V_2^2)$	
125218	Simplified Bernoulli	$\Delta P = 4 \cdot V_2^2$	
125219	Doppler Volume Flow	Volume flow = Conduit CSA * ( Velocity Time Integral )	
125220	Planimetry	Direct measurement of an area by tracing an irregular perimeter	
125221	Left Ventricle Mass by M-mode	Mass = $1.04 \cdot [(ST+LVID+PWT)^3 - LVID^3] \cdot 0.8 + 0.6$ . Mass unit is grams and length in cm.	

125222	Left Ventricle Mass by Truncated Ellipse	<p>Mass = <math>1.05 \Pi ( (b + t)^2 \times (2/3 (a + t) + d - d^3/3(a + t)^2 ) - b^2 (2/3a + d - d^3/3a^2) )</math></p> <p>a = Semi-major axis from widest minor axis radius to apex.  b = Short axis radius calculated from short axis cavity area  t = Myocardial thickness calculated from short axis epicardial and cavity areas  d = Truncated semi-major axis from widest short axis diameter to plane of mitral annulus.</p> <p>Mass unit is grams and length in cm.</p> <p><i>Schiller NB et al: Recommendations for quantification of the left ventricle by two-dimensional echocardiography, American Society of Echocardiography 2:364, 1989.</i></p>	
125223	4 Point Segment Finding Scale	<p>A four point, echocardiographic numeric scoring scheme of myocardium segments based on evaluation of wall motion and ventricle morphology.</p> <p><i>Recommendations for Quantitation of the Left Ventricle by Two-Dimensional Echocardiography, Journal of the American Society of Echocardiography, 2:358-367, 1989.</i></p>	
125224	5 Point Segment Finding Scale	<p>A five point, echocardiographic numeric scoring scheme of myocardium segments based on evaluation of wall motion and ventricle morphology.</p> <p><i>Recommendations for Quantitation of the Left Ventricle by Two-Dimensional Echocardiography, Journal of the American Society of Echocardiography, 2:358-367, 1989.</i></p>	
125225	5 Point Segment Finding Scale With Graded Hypokinesis	<p>A five point, echocardiographic numeric scoring scheme of myocardium segments based on evaluation of wall motion and ventricle morphology, with severity of hypokinesis graded.</p> <p><i>Recommendations for</i></p>	



		<i>Quantitation of the Left Ventricle by Two-Dimensional Echocardiography</i> , Journal of the American Society of Echocardiography, 2:358-367, 1989.	
125226	Single Plane Ellipse	Method of estimating volume from a planar ellipse. Equivalent to Biplane Ellipse with an assumption that the ellipse in the orthogonal plane has identical major and minor diameters.	
125230	Power Doppler	Color coded ultrasound images of blood flow which depict the amplitude, or power, of Doppler signals.	
125231	3D mode	Volumetric ultrasound imaging	
ARCHIVE	Archive	Archive device	
AS	<i>Angioscopy</i>	<i>Angioscopy device</i>	<i>Retired</i>
AU	Audio	Audio object	
BI	Biomagnetic imaging	Biomagnetic imaging device	
CAD	Computer Assisted Detection/Diagnosis	Computer Assisted Detection/Diagnosis device	
CAPTURE	Image Capture	Image Capture Device, includes video capture	
<i>CD</i>	<i>Color flow Doppler</i>	<i>Color flow Doppler</i>	<i>Retired</i> <i>Replaced by (US, DCM, "Ultrasound")</i>
<i>CF</i>	<i>Cinefluorography</i>	<i>Cinefluorography</i>	<i>Retired</i> <i>Replaced by (RF, DCM, "Radiofluorography")</i>
COMP	Computation Server	Computation Server; includes radiotherapy planning	
<i>CP</i>	<i>Culposcopy</i>	<i>Culposcopy</i>	<i>Retired</i>
CR	Computed Radiography	Computed Radiography device	
CS	<i>Cystoscopy</i>	<i>Cystoscopy</i>	<i>Retired</i>
CT	Computed Tomography	Computed Tomography device	
<i>DD</i>	<i>Duplex Doppler</i>	<i>Duplex Doppler</i>	<i>Retired</i>
<i>DF</i>	<i>Digital fluoroscopy</i>	<i>Digital fluoroscopy</i>	<i>Retired</i> <i>Replaced by (RF, DCM, "Radiofluorography")</i>
DG	Diaphanography	Diaphanography device	
<i>DM</i>	<i>Digital microscopy</i>	<i>Digital microscopy</i>	<i>Retired</i>
DOCD	Document Digitizer Equipment	Equipment that digitized hardcopy documents and	

		imported them.	
<i>DS</i>	<i>Digital Subtraction Angiography</i>	<i>Digital Subtraction Angiography</i>	<i>Retired Replaced by (XA, DCM, "X-Ray Angiography")</i>
DSS	Department System Scheduler	Department System Scheduler, workflow manager; includes RIS	
DX	Digital Radiography	Digital Radiography device	
<i>EC</i>	<i>Echocardiography</i>	<i>Echocardiography</i>	<i>Retired Replaced by (US, DCM, "Ultrasound")</i>
ECG	Electrocardiography	Electrocardiography device	
EPS	Cardiac Electrophysiology	Cardiac Electrophysiology device	
ES	Endoscopy	Endoscopy device	
F	Female	Female sex	
<i>FA</i>	<i>Fluorescein angiography</i>	<i>Fluorescein angiography</i>	<i>Retired Replaced by (OP, DCM, "Ophthalmic photography")</i>
FC	Female changed to Male	Female sex changed to Male sex	
FILMD	Film Digitizer	Film Digitizer	
FP	Female Pseudohermaphrodite	Female Pseudohermaphrodite	
<i>FS</i>	<i>Fundoscopy</i>	<i>Fundoscopy</i>	<i>Retired</i>
GM	General Microscopy	General Microscopy device	
H	Hermaphrodite	Hermaphrodite	
HC	Hard Copy	Hard Copy	
HD	Hemodynamic Waveform	Hemodynamic Waveform acquisition device	
IO	Intra-oral Radiography	Intra-oral Radiography device	
IVUS	Intravascular Ultrasound	Intravascular Ultrasound device	
KO	Key Object Selection	Key Object Selection object	
LOG	Procedure Logging	Procedure Logging device; includes cath lab logging	
<i>LP</i>	<i>Laparoscopy</i>	<i>Laparoscopy</i>	<i>Retired</i>
LS	Laser surface scan	Laser surface scan device	
M	Male	Male sex	
<i>MA</i>	<i>Magnetic resonance angiography</i>	<i>Magnetic resonance angiography</i>	<i>Retired Replaced by (MR, DCM, "Magnetic resonance")</i>
MC	Male changed to	Male sex changed to Female	

	Female	sex	
MCD	Media Creation Device	A device that creates DICOM PS 3.10 interchange media. For example, a CD creator that is managed by the Media Creation Management Service Class.	
MEDIM	Portable Media Importer Equipment	Equipment that retrieved and imported objects from interchange Media.	
MG	Mammography	Mammography device	
MP	Male Pseudohermaphrodite	Male Pseudohermaphrodite	
MR	Magnetic Resonance	Magnetic Resonance device	
MS	<i>Magnetic resonance spectroscopy</i>	<i>Magnetic resonance spectroscopy</i>	<i>Retired Replaced by (MR, DCM, "Magnetic resonance")</i>
NM	Nuclear Medicine	Nuclear Medicine device	
OCT	Optical Coherence Tomography	Modality device that uses an interferometric, non-invasive optical tomographic technique to image 2D slices and 3D volumes of tissue using visible and near visible frequencies.	
OP	Ophthalmic photography	Ophthalmic photography modality	
OPV	Ophthalmic Visual Field	Modality device that measures visual fields and perform visual perimetry.	
OPR	Ophthalmic Refraction	Modality device that measures the refractive characteristics of the eye.	
OPM	Ophthalmic Mapping	Modality device that measures corneal topography, corneal or retinal thickness, and other similar parameters that are typically displayed as maps.	
OT	Other Modality	Other Modality device	
PR	Presentation State	Presentation State object	
PRINT	Hard Copy Print Server	Hard Copy Print Server; includes printers with embedded DICOM print server	
PT	Positron emission tomography	Positron emission tomography (PET) device	
PX	Panoramic X-Ray	Panoramic X-Ray device	
REG	Registration	Registration	
RF	Radiofluoroscopy	Radiofluoroscopy device	
RG	Radiographic	Radiographic imaging	

	imaging	(conventional film/screen)	
RT	Radiation Therapy Device	Radiation Therapy Device; includes linear accelerator, proton therapy	
RTDOSE	Radiotherapy Dose	Radiotherapy Dose	
RTIMAGE	Radiotherapy Image	Radiotherapy Imaging device; includes portal imaging	
RTPLAN	Radiotherapy Plan	Radiotherapy Plan	
RTRECORD	Radiotherapy Treatment Record	Radiotherapy Treatment Record	
RTSTRUCT	Radiotherapy Structure Set	Radiotherapy Structure Set	
SEG	Segmentation	Segmentation	
SM	Slide Microscopy	Slide Microscopy	
SMR	Stereometric Relationship	Stereometric image pairing modality	
SR	Structured Report Document	Structured Report Document	
ST	Single-photon emission computed tomography	Single-photon emission computed tomography (SPECT) device	
TG	Thermography	Thermography device	
U	Unknown Sex	Unknown Sex	
US	Ultrasound	Ultrasound device	
VF	<i>Videofluorography</i>	<i>Videofluorography</i>	<i>Retired Replaced by (RF, DCM, "Radiofluoroscapy")</i>
VIDD	Video Tape Digitizer Equipment	Equipment that digitizes video tape and imports it.	
WSD	Workstation	Workstation	
XA	X-Ray Angiography	X-Ray Angiography device	
XC	External-camera Photography	External-camera Photography device	

### Annex E French Translations of Selected Codes used in the DCMR (Normative)

This Annex defines the French language code meanings for selected codes used in the DCMR.

Coding Scheme Designator	Coding Scheme Version	Code Value	Code Meaning English Language	Code Meaning French Language
BI	3.0	II.AC.a	0 - Need additional imaging evaluation	0. L'évaluation nécessite des compléments d'imagerie
BI	3.0	II.AC.b.1	1 – Negative	1. Négatif
SRT		F-01781	1 o'clock position	Situé à 1 heure
SRT		F-0178A	10 o'clock position	Situé à 10 heures
SRT		F-0178B	11 o'clock position	Situé à 11 heures
SRT		F-0178C	12 o'clock position	Situé à 12 heures
BI	3.0	II.AC.b.2	2 – Benign Finding	2. Constatations bénignes
SRT		F-01782	2 o'clock position	Situé à 2 heures
BI	3.0	II.AC.b.3	3 - Probably Benign Finding – short interval follow-up	3. Anomalie probablement bénigne - proposition d'une surveillance à court terme
SRT		F-01783	3 o'clock position	Situé à 3 heures
BI	3.0	II.AC.b.4	4 - Suspicious abnormality, biopsy should be considered	4. Anomalie suspecte, une biopsie doit être envisagée
SRT		F-01784	4 o'clock position	Situé à 4 heures
BI	3.0	II.AC.b.5	5 - Highly suggestive of malignancy, take appropriate action	5. Haute probabilité de malignité, une action appropriée doit être entreprise
SRT		F-01785	5 o'clock position	Situé à 5 heures
SRT		F-01786	6 o'clock position	Situé à 6 heures
SRT		F-01787	7 o'clock position	Situé à 7 heures
SRT		F-01788	8 o'clock position	Situé à 8 heures
SRT		F-01789	9 o'clock position	Situé à 9 heures
DCM		112063	Abnormal calcifications	Calcifications anormales
DCM		112028	Abnormal Distribution of Anatomic Structure	Distribution anormale des structures anatomiques
DCM		112004	Abnormal interstitial pattern	Opacité interstitielle
DCM		112061	Abnormal lines (1D)	Lignes anormales (1D)
DCM		112062	Abnormal lucency	Clarté anormale
DCM		112033	Abnormal opacity	Opacité anormale
DCM		112064	Abnormal texture	Texture anormale Note : If the term refers to a localized lesion the translation is

				"Texture anormale " but if the term refers to the entire lung it is more appropriate to use "Trame anormale".
SNM3		M-41610	Abscess	Abcès
DCM		112146	Acinar	Acinaire
DCM		112036	ACR Position Statement	Position de l'ACR
SRT		T-15420	Acromioclavicular Joint	Articulation acromioclaviculaire
SRT		T-12281	Acromion process of scapula	Acromion
SRT		G-A231	Acute	Aigu
DCM		121078	Addendum	Addendum
DCM		111135	Additional projections	Incidence complémentaire
SNM3		M-82003	Adenoid cystic carcinoma	Carcinome adénoïde kystique (cylindrome)
SNM3		M-83240	Adenolipoma	Adénolipome
SNM3		M-81400	Adenoma	Adénome
SNM3		M-89830	Adenomyoepithelioma	Adénomyoépithéliome
SNM3		M-74200	Adenosis	Adénose
SNM3		G-A127	Afferent	Afférent
DCM		112055	Agatston scoring method	Score de calcification coronaire par la méthode d'Agatston
DCM		112143	Air	Air
DCM		112070	Air bronchiogram	Bronchiogramme aérique
DCM		112071	Air bronchogram	Bronchogramme aérique
DCM		112072	Air crescent	Croissant aérique
DCM		112147	Air space	Espace aérique
DCM		112104	Air-fluid level	Niveau hydro-aérique
SRT		F-20240	Air-trapping	Piégeage
SRT		T-20001	Airway structure	Structure des voies aériennes
DCM		111001	Algorithm Name	Nom de l'algorithme
DCM		111002	Algorithm Parameters	Paramètres de l'algorithme
DCM		111003	Algorithm Version	Version de l'algorithme
DCM		111242	All algorithms succeeded; with findings	Tous les algorithmes ont réussi ; avec élément découvert
DCM		111241	All algorithms succeeded; without findings	Tous les algorithmes ont réussi ; sans élément découvert
SRT		F-01711	Almost entirely fat	Presque entièrement gras
SNM3		G-A174	Along edge	Au bord
SRT		F-0176C	Amorphous calcification	Calcification amorphe
SNM3		M-55160	Amyloid (tumor)	(Tumeur) amyloïde
DCM		111004	Analysis Performed	Analyse effectuée

DCM		112050	Anatomic Identifier	Identificateur anatomique
SNM3		F-10326	anatomical	Anatomique
SNM3		M-88610	Angiolipoma	Angiolipome
SNM3		M-76100	Angiomatosis	Angiomatose
SNM3		M-91203	Angiosarcoma	Angiosarcome (hémangiosarcome)
SRT		T-11307	Angle of rib	Angle de la côte
SNM3		G-A105	Anterior	Antérieur
DCM		112088	Anterior junction line	Ligne médiastinale antérieure
SRT		T-28630	Anterior segment of left upper lobe	Segment antérieur du lobe supérieur gauche
SRT		T-28230	Anterior segment of right upper lobe	Segment antérieur du lobe supérieur droit
SNM3		G-A180	Anterolateral	Antéro-latéral
DCM		111141	Any decision to biopsy should be based on clinical assessment	Une éventuelle décision de biopsie doit être basée sur l'évaluation clinique
SRT		T-42000	Aorta	Aorte
SRT		T-42300	Aortic arch	Crosse de l'aorte
SRT		T-42310	Aortic isthmus	Isthme aortique
DCM		112102	Aortic knob	Bouton aortique
SRT		T-35400	Aortic Valve	Valve aortique
SNM3		G-A122	Apical	Apical
SRT		G-A122	Apical	Apical
SNM3		M-84013	Apocrine adenocarcinoma	Carcinome apocrine
SNM3		M-73310	Apocrine Metaplasia	Métaplasie apocrine
DCM		112103	Arch of the Azygos vein	Crosse de la veine Azygos
SRT		T-11511	Arch of vertebra	Arc vertébral
DCM		112079	Architectural distortion	Modification des rapports anatomiques
SRT		F-01795	Architectural distortion of breast	Distorsion architecturale du sein
SNM3		G-A166	Area	Surface
SRT		G-A16A	Area of defined region	Surface de la région définie
DCM		121056	Area Outline	Tracé de la surface
DCM		111215	Artifact(s) other than grid or detector artifact	Artéfacts autres qu'artéfacts de grille ou du détecteur
SRT		T-42100	Ascending aorta	Aorte thoracique ascendante
DCM		111005	Assessment Category	Catégorie d'évaluation
DCM		112003	Associated Chest Component	Structure anatomique du thorax
SRT		F-01793	Asymmetric breast tissue	Tissu mammaire asymétrique
SRT		P5-B3412	Asymmetric breast tissue	Analyse de l'asymétrie du tissu

			analysis	mammaire
SRT		F-8A063	Asynchronous involution of breast	Involution asynchrone du sein
SRT		D4-31220	Atrial Septal Defect	Communication inter atriale
SRT		T-32100	Atrium	Atrium ou Oreillette
DCM		121089	Attending (syn. Consultant)	Consultant
DCM		112031	Attenuation Coefficient	Coefficient d'atténuation
SNM3		M-72175	Atypical intraductal hyperplasia	Hyperplasie intracanalairé atypique
SNM3		M-72105	Atypical lobular hyperplasia	Hyperplasie lobulaire atypique
SNM3		G-A147	Axial	Axial
SRT		F-01794	Axilla position	Situation axillaire
BI	3.0	I.E.6	Axillary adenopathy	Adénopathie axillaire
SRT		T-47100	Axillary Artery	Artère axillaire
SRT		T-18774	Axillary Fascia	Fascia axillaire
DCM		111301	Axillary nodal metastases	Métastases ganglionnaires axillaire
DCM		111253	Axillary node hyperplasia	Hyperplasie dans ganglion axillaire
DCM		111252	Axillary node with calcifications	Ganglion axillaire avec calcifications
DCM		111300	Axillary node with lymphoma	Lymphome dans ganglion axillaire
SNM3		R-102D1	Axillary Tail	Prolongement axillaire
SRT		F-0178E	Axillary tail position	Situé dans le prolongement axillaire du sein
SRT		T-49110	Axillary vein	Veine axillaire
DCM		112090	Azygoesophageal recess interface	Ligne para-azygo-oesophagienne
SRT		T-48340	Azygos vein	Grande veine Azygos
SNM3		G-A123	Basal	Basal
DCM		111307	Basal cell carcinoma of the nipple	Carcinome basocellulaire du mamelon
DCM		121079	Baseline	Référence
DCM		112016	Baseline Category	Catégorie à T0
DCM		112154	Bat's wing distribution	No translation is provided Note: In France, the two concepts as described in Annex D 112154 and 112155 are not distinguished. For this reason both "Bat's wing" and "Butterfly distribution" are translated as "Aspect en aile de papillon".
SNM3		A-32475	BB shot (Lead Pellet)	Marque de plomb (Grain de plomb)



DCM		112066	Beaded septum sign	Septa perlés
DCM		111256	Benign Calcifications	Calcifications bénignes
DCM		111255	Benign cyst with blood	Kyste bénin hémorragique
SNM3		D7-F0810	Benign neoplasm of nipple of female breast (Nipple adenoma)	Adénomatosose ( papillomatose) érosive du mamelon
DCM		121080	Best illustration of finding	Meilleure illustration des résultats
DCM		112049	Best Overall Response	La meilleure réponse
SNM3		G-A102	Bilateral	Bilatéral
DCM		111143	Biopsy should be considered	Une biopsie doit être envisagée
DCM		111148	Biopsy should be strongly considered	Une biopsie doit être absolument envisagée
DCM		111303	Blood vessel (vascular) invasion	Embole vasculaire
SRT		T-11220	Body of sternum	Corps du sternum
DCM		112007	Border definition	Définition des bords
DCM		112015	Border shape	Forme des bords
SNM3		T-04080	Both breasts	Les deux seins
SRT		T-47160	Brachial artery	Artère brachiale
SRT		T-A9090	Brachial plexus	Plexus brachial
SRT		T-46010	Brachiocephalic trunk	Tronc artériel brachio-céphalique
SRT		T-48620	Brachiocephalic vein	Tronc veineux brachio-céphalique
SNM3		T-04000	Breast	Sein
SRT		F-01710	Breast composition	Composition du sein (des seins)
SRT		P5-B3414	Breast composition analysis	Analyse de la composition du sein (des seins)
DCM		111100	Breast geometry	Morphologie du sein (des seins)
SNM3		D7-90428	Breast lobular hyperplasia	Hyperplasie lobulaire mammaire
DCM		111007	Breast Outline including Pectoral Muscle Tissue	Limites du sein incluant le muscle pectoral
SNM3		T-04000	Breast, NOS	Sein, SAI
SRT		R-40939	Bronchial	Bronchique
SRT		T-46310	Bronchial artery	Artère bronchique
DCM		112052	Bronchovascular	Broncho-vasculaire
SRT		T-26000	Bronchus	Bronche
SNM3		A-32110	Bullet	Balle
DCM		112155	Butterfly distribution	Aspect en ailes de papillon
DCM		111017	CAD Processing and	Résumé du traitement et des

			Findings Summary	résultats du système de DAO <sup>1</sup>
SRT		F-01775	Calcification Cluster	Foyer de microcalcifications
DCM		112030	Calcification Descriptor	Descripteur des calcifications
DCM		111008	Calcification Distribution	Distribution des calcifications
DCM		112018	Calcification extent as percent of surface	% de surface calcifiée
DCM		112019	Calcification extent as percent of volume	% de volume calcifié
DCM		111009	Calcification Type	Type de calcification
SRT		F-01769	Calcified skin of breast	Calcification cutanée
SRT		F-0176A	Calcified suture material	Fils de suture calcifiés
DCM		112145	Calcium	Calcium
DCM		112058	Calcium score	Score de calcification
DCM		112034	Calculation Description	Description du calcul
SNM3		G-A171	Capsular	Capsulaire
DCM		111304	Carcinoma in children	Carcinome de l'enfant
DCM		111305	Carcinoma in ectopic breast	Carcinome sur glande mammaire ectopique
DCM		111310	Carcinoma in pregnancy and lactation	Carcinome au cours de la grossesse et de la lactation
SNM3		D7-F0902	Carcinoma in situ of male breast	Carcinome de l'homme
DCM		111306	Carcinoma with endocrine differentiation	Carcinome avec différenciation endocrine
SNM3		M-85733	Carcinoma with metaplasia	Carcinome métaplasique
SNM3		M-89803	Carcinosarcoma	Carcinosarcome
SRT		A-040CB	Cardiac pacemaker lead	Electrode de pace-maker cardiaque
SRT		T-25201	Carina	Carène
DCM		112086	Carina angle	Angle carinaire
SRT		T-B4000	Carotid Body	Corpuscule carotidien
DCM		111309	Cartilaginous and osseous change	Métaplasie cartilagineuse ou osseuse
SNM3		A-26800	Catheter	Cathéter
SNM3		G-A108	Caudal	Caudal
SNM3		G-A108	Caudal	Caudal
SNM3		G-A107	Caudal-cranial	Pieds-tête
SNM3		R-10244	caudo-cranial (from below)	Face caudo-craniale
DCM		112017	Cavity extent as percent of volume	Taille de la cavité en % du volume

<sup>1</sup> DAO = Détection Assistée par Ordinateur

DCM		111203	CC Nipple not centered on image	Cranio-caudal: mamelon non centré sur l'image
DCM		111202	CC Not all medial tissue visualized	Cranio-caudal: le tissu interne n'est pas totalement visible
DCM		111204	CC Posterior nipple line does not measure within 1 cm of MLO	Cranio-caudal: longueur de la ligne rétroaréolaire sur la face plus courte de plus d'un centimètre que sur l'oblique
DCM		111010	Center	Centre
UCUM		cm	centimeter	Centimètre
SNM3		G-A110	Central	Central
SRT		G-A110	Central	Central
DCM		112174	Central line	Cathéter central
SRT		F-0178F	Central portion of breast position	Situé dans la partie centrale du sein
DCM		112156	Centrilobular	Centro-lobulaire
DCM		112087	Centrilobular structures	Structures centro-lobulaires
SNM3		G-A107	Cephalic	Céphalique
SNM3		G-A107	Cephalic	Céphalique
DCM		111011	Certainty of Feature	Certitude concernant la caractéristique
DCM		111012	Certainty of Finding	Certitude concernant le résultat
DCM		111013	Certainty of Impression	Certitude concernant l'impression
SRT		A-12210	Cervical collar	Minerve
DCM		112000	Chest CAD Report	Compte-rendu de la DAO du thorax
DCM		112173	Chest tube	Drain thoracique
SRT		T-D3050	Chest wall	Paroi thoracique
SNM3		M-92200	Chondroma	Chondrome
SNM3		M-92203	Chondrosarcoma	Chondrosarcome
SRT		T-35020	Chordae tendineae cordis	Cordage
SRT		G-A270	Chronic	Chronique
SNM3		M-02560	Circumference	Circonférence
DCM		112142	Circumscribed	Circonscrit
SRT		F-01741	Circumscribed lesion	Lésion_circonscrite (bien définie_ou à_contour net)
SRT		T-12310	Clavicle	Clavicule
SRT		T-11219	Clavicular notch of sternum	Incisure claviculaire du sternum
SNM3		R-102D2	Cleavage	Sillon inter-mammaire
SNM3		A-12062	Clip	Clip
DCM		111014	Clockface or region	Quadrant ou région

DCM		112157	Coalescent	Confluent
SRT		F-01761	Coarse (popcorn-like) calcification	Grossière (en popcorn ou coralliforme)
DCM		112178	Coin	Pièce de monnaie
SRT		F-20172	Coin lesion	Lésion nodulaire
DCM		111195	Collimation too close to breast	Collimation trop proche du sein
SNM3		A-10044	Collimator	Collimateur
SNM3		M-85012	Comedocarcinoma (intraductal)	Carcinome intracanalair de type comédo
SRT		T-45100	Common carotid artery	Artère carotide commune
DCM		111015	Composite Feature	Caractéristique composite
DCM		112023	Composite Feature Modifier	Modificateur lié à une anomalie à caractéristiques composites
DCM		111016	Composite type	Type composite
DCM		110004	Computer Aided Detection	Système de Détection Assistée par Ordinateur
DCM		110003	Computer Aided Diagnosis	Système de Diagnostic Assisté par Ordinateur
DCM		121077	Conclusion	Conclusion
DCM		121076	Conclusions	Conclusions
DCM		111018	Content Date	Date du contenu
DCM		111019	Content Time	Heure du contenu
SNM3		C-B0300	Contrast agent NOS	Produit de contraste, SAI
SRT		T-12282	Coracoid process of scapula	Apophyse coracoïde
DCM		112105	Corona radiata	Couronne radiaire
SNM3		G-A138	Coronal	Coronal
SRT		T-11240	Costal Cartilage	Cartilage costal
SRT		T-11308	Costal groove	Sillon de la côte
SRT		T-46180	Costocervical trunk	Tronc cervico-thoracique
SNM3		G-A108	Cranial-caudal	Tête-pieds
SNM3		G-A108	Cranio-caudal	Cranio-caudal
SNM3		R-10242	cranio-caudal	Face
SNM3		Y-X1770	cranio-caudal exaggerated laterally	Face exagérée externe
SNM3		Y-X1771	cranio-caudal exaggerated medially	Face exagérée interne
LN		18747-6	CT Report	Compte rendu TDM
UCUM		cm3	Cubic centimeter	Centimètre cube
UCUM	1.4	dm3	Cubic decimeter	Décimètre cube
UCUM		um3	Cubic micrometer	Micromètre cube
UCUM		mm3	Cubic millimeter	Millimètre cube

SNM3		F-10410	curled-up	En chien de fusil
DCM		121064	Current Procedure Descriptions	Description de la procédure en cours
DCM		112048	Current Response	Réponse actuelle
SNM3		D7-90360	Cyst of breast	Kyste du sein
DCM		111147	Cytologic analysis	Analyse cytologique
DCM		111193	Date sticker is missing	L'étiquette de date est absente
UCUM	1.4	d	Day	Jour
SRT		F-01727	Decrease in number of calcifications	Diminution du nombre de calcifications
SRT		M-02530	Decrease in size	Diminution de taille
SNM3		G-A140	Deep	Profond
SRT		T-13660	Deltoid muscle	Muscle deltoïde
DCM		112118	Density	Densité Note: Typically used with chest CT
SRT		F-01796	Mammography breast density	Opacité mammaire à la mammographie
DCM		112119	Dependent opacity	Opacité déclive
SRT		G-D785	Depth	Profondeur
DCM		111020	Depth	Profondeur
DCM		121401	Derivation	Méthode de calcul
SRT		T-D0765	Descending aorta	Aorte thoracique descendante
DCM		111021	Description of Change	Description des modifications
DCM		111022	Detection Performed	Détection effectuée
DCM		111214	Detector artifact(s)	Artéfacts du détecteur
DCM		111259	Diabetic fibrous mastopathy	Mastopathie diabétique
SNM3		M-02550	Diameter	Diamètre
SRT		G-A198	Diameter of circumscribed circle	Diamètre du cercle circonscrit
SRT		T-D3400	Diaphragm	Diaphragme
DCM		110011	Dictation	
DCM		112166	Difference in border definition	Modification de la netteté des bords
DCM		112165	Difference in border shape	Modification de la forme des bords
DCM		112167	Difference in distribution	Modification de la distribution
SRT		F-017B3	Difference in location	Différence de localisation
SRT		F-017B7	Difference in margin	Différence de contours
SRT		F-017B5	Difference in number of calcifications	Différence du nombre de calcifications
SRT		F-017B2	Difference in opacity	Différence d'opacité
SRT		F-017B6	Difference in shape	Différence de forme

DCM		112168	Difference in site involvement	Modification du siège des lésions
SRT		F-017B1	Difference in size	Différence de taille
SRT		F-017B4	Difference in spatial proximity	Différence de proximité dans l'espace
SRT		F-017B8	Difference in symmetry	Différence de symétrie
DCM		112170	Difference in Texture	Modification de texture
DCM		112169	Difference in Type of Content	Modification du contenu
DCM		111023	Differential Diagnosis/Impression	Diagnostic différentiel/Impression
SRT		G-A321	Diffuse	Diffus
SRT		F-01770	Diffuse calcification distribution	Calcifications diffuses(disséminées)
SRT		M-020FA	Discoïd	Discoïde
SRT		G-A324	Disseminated	Disséminé
SNM3		G-A119	Distal	Distal
DCM		121206	Distance	
DCM		112138	Distinctly defined	Distincts les uns des autres
DCM		112006	Distribution Descriptor	Descripteur de la distribution
DCM		113011	Document Title Modifier	Modificateur du titre du document
SNM3		G-A106	Dorsal	Dorsal
SRT		T-12287	Dorsal aspect of scapula	Corps de l'omoplate
SRT		T-461A0	Dorsal scapular artery	Artère scapulaire postérieure
DCM		111258	Ductal adenoma	Adénome ductal
SNM3		M-72170	Ductal hyperplasia, Usual	Hyperplasie canalaire
SRT		P5-40060	mammary ductogram	Galactographie
SRT		F-01762	Dystrophic calcification	Dystrophique
SNM3		D4-48014	Ectopic (accessory) breast tissue	Tissu mammaire ectopique (glande mammaire accessoire)
SNM3		M-36300	Edema	Oedème
SNM3		G-A174	Edge	Bord
SNM3		G-A128	Efferent	Efférent
SRT		F-01763	Eggshell calcification	En coquille d'oeuf
DCM		111217	Electrical failure	Défaillance électrique
DCM		112134	Elliptic	Elliptique
SRT		A-25350	Endotracheal tube	Tube endotrachéal
SRT		R-40750	Enlarged	Augmenté de taille
SNM3		M-33410	Epidermal inclusion cyst	Kyste épidermique
SRT		F-01752	Equal density (isodense) lesion	Lésion de densité identique (isodense)

SNM3		F-10440	erect	Debout
SRT		T-14020	Erector spinae muscle	Muscles érecteurs du rachis
SRT		T-4630D	Esophageal artery	Artère oesophagienne
SRT		T-D3412	Esophageal Hiatus	Hiatus oesophagien
SRT		T-56000	Esophagus	Oesophage
SRT		R-10260	Estimated	Estimé
SNM3		R-102CF	exaggerated cranio-caudal	Face exagérée
SNM3		G-A112	External	Externe
SRT		R-40941	External	Externe
SRT		T-1416B	External intercostal muscle	Muscle intercostal externe
SNM3		M-88211	Extra abdominal desmoid	Tumeur desmoïde extraabdominale
SNM3		G-A151	Extra-articular	Extra-articulaire
SRT		F-01714	Extremely dense	Très dense
DCM		112131	Extremely small	Extrêmement petit
DCM		111224	Failed	Echec
DCM		111024	Failed Analyses	Échec des analyses
DCM		111025	Failed Detections	Échec des détections
SRT		T-D0634	Fascial layer	Fascia
SRT		T-D008A	Fat	Graisse
SRT		F-01754	Fat containing (radiolucent) lesion	Lésion contenant de la graisse (radiotransparent)
SNM3		D7-90434	Fat necrosis of breast	Cytostéatonécrose mammaire
DCM		111159	Feature detected on images from multiple modalities	Caractéristique détectée sur les images provenant de plusieurs modalités
DCM		111158	Feature detected on multiple images	Caractéristique détectée sur plusieurs images
DCM		111157	Feature detected on only one of the images	Caractéristique détectée sur une seule des images
DCM		111156	Feature detected on the only image	Caractéristique détectée sur la seule image
SRT		A-26430	Feeding tube	Sonde d'alimentation
DCM		F	female	Femme
DCM		111264	Fibroadenolipoma	Adénofibrolipome
SNM3		M-90100	Fibroadenoma	Fibroadénome
DCM		111263	Fibroadenomatoid hyperplasia	Hyperplasie fibroadénomatoïde
DCM		112163	Fibrocalcific	Fibrocalcique
SNM3		D7-90310	Fibrocystic disease of breast	Dysplasie fibrokystique du sein
SNM3		M-78800	Fibromatosis	Fibromatose

DCM		112148	Fibronodular	Fibro-nodulaire
SNM3		M-88103	Fibrosarcoma	Fibrosarcome
DCM		112171	Fiducial mark	Point de repère
DCM		110010	Film	
DCM		121071	Finding	Résultat
SRT		F-01722	Finding partially removed	Exérèse partielle de l'élément
DCM		121070	Findings	Résultats
SRT		F-0176D	Fine, linear (casting) calcification	Calcification fine linéaire (vermiculaire)
SRT		F-0176E	Fine, linear, branching (casting) calcification	Calcification fine linéaire, arborisée_(ramifiée)
SRT		T-D051D	Fissure of lung	Scissure
DCM		111191	Flash doesn't include cassette/screen/detector identification	Le marquage n'indique pas l'identifiant de cassette/écran/détecteur
DCM		111188	Flash doesn't include date of examination	Le marquage n'indique pas la date de l'examen
DCM		111189	Flash doesn't include facility name and location	Le marquage n'indique ni le nom de l'établissement ni son adresse
DCM		111192	Flash doesn't include mammography unit identification	Le marquage n'indique pas l'identifiant du mammographe
DCM		111187	Flash doesn't include patient name and additional patient id	Le marquage n'indique ni le nom du patient ni son identifiant.
DCM		111186	Flash is illegible, does not fit, or is lopsided	Le marquage est illisible, mal positionné ou de travers
DCM		111185	Flash is not near edge of film	Le marquage n'est pas au bord du film
DCM		112107	Fleischner's line(s)	Ligne(s) de Fleischner
DCM		112164	Flocculent	Floconneux
DCM		112149	Fluffy	Flou Note: the word-to-word translation of "Fluffy" is "Duveteux", but this term is never used. For tissues, the translation must be "Floconneux" but this term is only used for calcifications (Flocculent = Floconneux) in CID 6132. We retained "Flou" (in English, "Fuzzy") as the most appropriate.
SRT		G-A351	Focal	Localisé
SRT		F-01792	Focal asymmetric breast tissue	Asymétrie focale du tissu mammaire
SRT		P5-B3410	Focal asymmetric density analysis	Analyse de l'asymétrie de densité focale
SNM3		M-78266	Focal fibrosis	Fibrose focale



DCM		111142	Follow-up at short interval (1-11 months)	Surveillance à court terme (1-11 mois)
DCM		113005	For Conference	Pour une conférence
DCM		113007	For Patient	Pour le patient
DCM		113008	For Peer Review	Pour relecture par un pair
DCM		113002	For Referring Provider	Pour le référent
DCM		113009	For Research	Pour la recherche
DCM		113003	For Surgery	Pour la chirurgie
DCM		113004	For Teaching	Pour l'enseignement
DCM		113006	For Therapy	Pour la thérapeutique
SNM3		M-44140	Foreign body (reaction)	Réaction à corps étranger
SRT		M-30400	Foreign material (iodized oil, mercury, talc)	Corps étranger (lipiodol, mercure, talc)
SNM3		F-10380	frog	Position de la grenouille
SNM3		G-A138	Frontal	Frontal
SNM3		D7-90364	Galactoceles	Galactocèle
SRT		G-A366	Generalized	Généralisé
SNM3		M-90160	Giant fibroadenoma	Adénofibrome géant
SRT		T-1228A	Glenoid cavity of scapula	Cavité glénoïde
SNM3		M-83153	Glycogen-rich carcinoma	Carcinome riche en glycogène
SNM3		M-95800	Granular cell tumor	Tumeur à cellules granuleuses
DCM		112128	Granular pattern	Aspect micronodulaire
DCM		111208	Grid artifact(s)	Artéfact(s) de grille
DCM		112120	Ground glass opacity	Opacité en verre dépoli
SRT		F-01772	Grouped calcification distribution	Calcification groupées (ou en foyer)
SNM3		G-A169	Gutter	Gouttière
SNM3		D7-90420	Gynecomastia	Gynécomastie
DCM		112073	Halo sign	Signe du halo
SNM3		M-75500	Hamartoma	Hamartome
SRT		T-11301	Head of rib	Tête de la côte
SRT		T-32000	Heart	Coeur
SRT		A-04110	Heart valve prosthesis	Prothèse valvulaire
SNM3		M-91200	Hemangioma	Hémangiome
SNM3		D3-F0620	Hemangioma of subcutaneous tissue	Hémangiome des tissus sous-cutané
SNM3		M-91220	Hemangioma – venous	Hémangiome veineux
SNM3		M-91501	Hemangiopericytoma	Hémangiopéricytome
SNM3		M-35060	Hematoma	Hématome
SRT		F-0176F	Heterogeneous calcification	Calcification punctiforme irrégulière (polymorphe, hétérogène)
SRT		F-01713	Heterogeneously dense	Dense et hétérogène

DCM		112095	Hiatus	Hiatus
SRT		F-01751	High density lesion	Lésion de forte densité
DCM		111149	Highly suggestive of malignancy – take appropriate action	Haute probabilité de malignité - une action appropriée doit être entreprise
SNM3		G-A170	Hilar	Hilaire
SRT		T-28080	Hilum of lung	Hile pulmonaire
SNM3		G-A170	Hilus	Hile
DCM		111145	Histology using core biopsy	Histologie par biopsie à l'aiguille
DCM		121060	History	Antécédents
SNM3		M-96503	Hodgkin's disease (lymphoma)	Maladie de Hodgkin
DCM		112160	Homogeneous (uniform opacity)	Homogène (opacité uniforme)
DCM		112106	Honeycomb pattern	Aspect en rayon de miel
SNM3		G-A142	Horizontal	Horizontal
SRT		G-A142	Horizontal	Horizontal
DCM		111026	Horizontal Pixel Spacing	Espacement horizontal des pixels
UCUM		h	hour	Heure
SRT		T-12410	Humerus	Humérus
DCM		112159	Hyper-acute	Suraigu
SNM3		M-72000	Hyperplasia, usual	Hyperplasie simple
SNM3		A-16016	ID Plate	Zone d'identification
SRT		T-14030	Iliocostalis muscle	Muscle ilio-costal
DCM		111027	Image Laterality	Latéralité de l'image
DCM		111028	Image Library	Bibliothèque d'images
DCM		110001	Image Processing	
DCM		111101	Image Quality	Qualité image
SRT		P5-B3408	Image quality analysis	Analyse de la qualité d'image
DCM		111029	Image Quality Rating	Score de qualité image
DCM		111030	Image Region	Région de l'image
DCM		111031	Image View	Incidence
DCM		111032	Image View Modifier	Modificateur de l'incidence
SNM3		A-04010	Implant	Prothèse
SNM3		R-102D5	Implant Displaced	Prothèse déplacée
SRT		F-0172B	Implant revised since previous mammogram	Prothèse révisée depuis la mammographie précédente
DCM		121073	Impression	Impression
DCM		111033	Impression Description	Description de l'impression
DCM		121072	Impressions	Impressions
DCM		111196	Inadequate compression	Compression inadéquate

DCM		111219	Inappropriate image processing	Défaillance du processus de traitement d'image
SRT		F-01726	Increase in number of calcifications	Augmentation du nombre de calcifications
SRT		M-02520	Increase in size	Augmentation de taille
SRT		F-01744	Indistinct lesion	Lésion indistincte
SRT		F-01776	Individual Calcification	Calcification isolée
DCM		111233	Individual Impression / Recommendation Analysis	Analyse de l'Impression / recommandation élémentaire
DCM		111034	Individual Impression/Recommendation	Impression élémentaire/Recommandation
SNM3		D7-90452	Infarction of breast	Infarctus mammaire
SNM3		G-A115	Inferior	Inférieur
SRT		T-116EF	Inferior articular facet of axis	Facette articulaire inférieure de l'axis
SRT		T-1153F	Inferior articular process of vertebra	Massif articulaire inférieur
SRT		T-46940	Inferior phrenic artery	Artère phrénique inférieure
SRT		T-48710	Inferior vena cava	Veine cave inférieure
DCM		112121	Infiltrate	Infiltrat
SNM3		M-85003	Infiltrating duct carcinoma	Carcinome canalaire infiltrant
SNM3		M-40000	Inflammation	Infection
SNM3		M-85303	Inflammatory carcinoma	Carcinome inflammatoire
SRT		T-13620	Infraspinatus muscle	Muscle sous épineux
DCM		112161	Inhomogeneous	Hétérogène
SNM3		G-A113	Inner	En dedans
SRT		T-14165	Innermost intercostal muscles	Muscles intercostaux intimes
DCM		111240	Institutionally defined quality control standard	Standards de contrôle de qualité définis par l'institution
DCM		111206	Insufficient implant displacement incorrect	Refoulement de la prothèse insuffisant
SRT		T-D305A	Intercostal artery	Artère intercostale
DCM		112082	Interface	Interface
SNM3		G-A114	Intermediate	Intermédiaire
DCM		121085	Intern	Interne
SNM3		G-A113	Internal	Interne
SRT		R-40819	Internal	Interne
SRT		T-14183	Internal intercostal muscle	Muscle intercostal interne
SRT		T-48170	Internal jugular vein	Veine jugulaire interne
SRT		T-46200	Internal thoracic artery	Artère thoracique interne

DCM		110005	Interpretation	
SRT		T-1A007	Interstitial tissue	Interstitium
SRT		T-32410	Interventricular septum	Septum interventriculaire
SNM3		G-A15A	Intra-articular	Intra-articulaire
DCM		111315	Intracystic papillary carcinoma	Carcinome papillaire intrakystique
SNM3		M-85040	Intracystic papilloma	Papillome intrakystique
SNM3		M-85072	Intraductal carcinoma micro-papillary	Carcinome intracanaulaire de type micropapillaire
DCM		111341	Intraductal carcinoma, high grade	Carcinome intracanaulaire
DCM		111313	Intraductal carcinoma, low grade	Carcinome intracanaulaire de bas grade
DCM		111312	Intraductal comedocarcinoma with necrosis	Carcinome intracanaulaire de type comédo avec nécrose
SNM3		M-85030	Intraductal papilloma	Papillome intragalactophorique
DCM		112108	Intralobular lines	Lignes intra-lobulaires
SNM3		T-C4351	Intra-mammary lymph node	Ganglion intrammaire
DCM		111316	Invasive and in-situ carcinoma	Carcinome infiltrant et in situ
SNM3		M-82013	Invasive cribriform carcinoma	Carcinome infiltrant cribriforme
SNM3		M-85203	Invasive lobular carcinoma	Carcinome lobulaire infiltrant
SNM3		F-10349	inverse Trendelenburg	Trendelenburg inversé
SNM3		G-A402	Irregular	Irrégulière
SNM3		A-1016B	J Wire	Hameçon
SRT		A-26434	Jejunostomy tube	Tube de jéjunostomie
SRT		A-61000	Jewelry	Bijoux
SNM3		M-90300	Juvenile fibroadenoma	Fibroadénome juvénile
DCM		111277	Juvenile papillomatosis	Papillomatose juvénile
DCM		112109	Kerley A line	Ligne A de Kerley
DCM		112110	Kerley B line	Ligne B de Kerley
DCM		112111	Kerley C lines	Lignes C de Kerley
DCM		113012	Key Object Description	Description de l'objet clé
DCM		112175	Kidney stent	Stent rénal
SNM3		F-10336	knee-chest	Genu pectoral
SNM3		F-10330	kneeling	À genou [à genou]
SNM3		M-82040	Lactating adenoma	Adénome lactant
DCM		111279	Lactational change	Lobule sécrétant
SRT		T-11514	Lamina of vertebra	Lame de la vertèbre
SRT		G-A405	Laminated	Lamellaire

SRT		R-404AA	Large	Gros
DCM		111281	Large duct papilloma	Papillome solitaire
SRT		F-01764	Large rod-like calcification	Calcification en bâtonnet
SNM3		G-A104	Lateral	Externe
SNM3		F-10318	lateral decubitus	Décubitus latéral
SRT		G-C171	Laterality	Latéralité
SNM3		R-10228	latero-medial	Profil externe
SNM3		R-10230	latero-medial oblique	Latéro-médial oblique
SRT		T-14172	Latissimus dorsi muscle	Muscle grand dorsal
SNM3		G-A101	Left	Gauche
SNM3		T-04030	Left breast	Sein gauche
SNM3		G-A101	Left lateral	Latéral gauche
SNM3		F-10319	left lateral decubitus	Décubitus latéral gauche
SRT		T-26500	Left main bronchus	Bronche principale gauche
SNM3		M-88900	Leiomyoma	Léiomyome
SNM3		M-88903	Leiomyosarcoma	Léiomyosarcome
SRT		G-A22A	Length	Longueur
DCM		111035	Lesion Density	Densité de la lésion
SRT		F-01728	Less defined	Moins bien défini
DCM		111318	Leukemic infiltration	Infiltration leucémique
SRT		T-14150	Levatores costarum muscles	Muscles éleveurs des côtes
SRT		T-42370	Ligamentum arteriosum	Ligament artériel
DCM		112083	Line	Ligne
DCM		112150	Linear	Linéaire
SRT		F-01771	Linear calcification distribution	Distribution linéaire des calcifications
SNM3		M-83143	Lipid-rich (lipid-secreting) carcinoma	Carcinome à cellules lipidiques
SNM3		M-88500	Lipoma of the breast	Lipome
SNM3		M-88503	Liposarcoma	Liposarcome
SNM3		F-10346	lithotomy	Lithotomie
DCM		112158	Lobar	Lobaire
SRT		T-28770	Lobe of lung	Lobe pulmonaire
SNM3		G-A640	Lobular	Lobulée
SNM3		D7-F0A02	Lobular carcinoma in situ of breast	Carcinome lobulaire in situ mammaire
DCM		112135	Lobulated	Lobulée
DCM		112013	Location in Chest	Localisation thoracique
SNM3		G-A185	Long Axis	Grand axe
SRT		T-14040	Longissimus muscle	Muscle longissimus du thorax

SNM3		G-A143	Longitudinal	Longitudinal
SRT		F-01753	Low density (not containing fat) lesion	Faible densité (sans contenu graisseux)
SRT		T-04003	Lower inner quadrant of breast	Quadrant inféro-interne du sein
SNM3		T-04003	Lower inner quadrant of breast, NOS	Quadrant inféro-interne du sein, SAI
SRT		T-28830	Lower lobe of lung	Lobe pulmonaire inférieur
SRT		T-04005	Lower outer quadrant of breast	Quadrant inféro-externe du sein
SNM3		T-04005	Lower outer quadrant of breast, NOS	Quadrant inféro-externe du sein, SAI
SRT		T-D320A	Lower zone of lung	Zone inférieure du poumon
DCM		112084	Lucency	Clarté
SRT		F-01766	Lucent-centered calcification	Calcification à centre clair
SRT		T-28000	Lung	Poumon
DCM		111320	Lymphatic vessel invasion	Embole lymphatique
SNM3		T-C4000	Lymph node	Ganglion lymphatique
SNM3		M-95903	Lymphoma	Lymphome
SNM3		R-102D6	Magnification	Agrandissement
SNM3		R-102D6	Magnification views	Agrandissements
SRT		G-A193	Major Axis	Axe principal
DCM		M	male	Homme
SNM3		M-88303	Malignant fibrous histiocytoma	Histiocytofibrome malin
DCM		111334	Malignant melanoma of nipple	Mélanome malin du mamelon
SNM3		D7-90370	Mammary duct ectasia	Galactophorite ectasiente mammaire (ectasie canalaire mammaire)
SRT		F-01791	Mammographic breast mass	Masse du sein à la mammographie
DCM		111036	Mammography CAD Report	Compte rendu d'analyse mammographique par système de DAO
SRT		T-11211	Manubrium of sternum	Manubrium sternal
SNM3		G-A177	Marginal	Marginal
DCM		111037	Margins	Contours
SRT		M-03000	Mass	Masse
DCM		112057	Mass scoring method	Appréciation de la charge calcique par la méthode du score de masse
DCM		112180	Maximum Attenuation Coefficient	Coefficient d'atténuation maximum

DCM		112181	Mean Attenuation Coefficient	Coefficient d'atténuation moyen
DCM		112051	Measurement of Response	Quantification de la réponse
DCM		111216	Mechanical failure	Défaillance mécanique
SNM3		G-A109	Medial	Médial
SNM3		G-A109	Median	Médian
DCM		112182	Median Attenuation Coefficient	Médiane des coefficients d'atténuation
SRT		T-D3300	Mediastinum	Médiastin
SNM3		R-10224	medio-lateral	Profil interne
SNM3		R-10226	medio-lateral oblique	Médiolatéral oblique
SRT		R-404A9	Medium	Moyen
SNM3		M-85103	Medullary carcinoma	Carcinome médullaire
SNM3		J-83250	Metal (Lead) Marker	Marqueur (plombé)
DCM		111333	Metastasis to an intramammary lymph node	Ganglion intramammaire métastatique
DCM		111323	Metastatic cancer to the breast	Cancer métastatique au sein
DCM		111324	Metastatic cancer to the breast from the colon	Métastase intramammaire d'un cancer colique
DCM		111325	Metastatic cancer to the breast from the lung	Métastase intramammaire d'un cancer pulmonaire
DCM		111327	Metastatic cancer to the breast from the ovary	Métastase intramammaire d'un cancer ovarien
DCM		111330	Metastatic disease to axillary node	Ganglion axillaire métastatique
DCM		111326	Metastatic melanoma to the breast	Métastase intramammaire d'un mélanome malin
DCM		111328	Metastatic sarcoma to the breast	Métastase intramammaire d'un sarcome
DCM		111284	Microglandular adenosis	Adénose microglandulaire
SRT		F-01742	Microlobulated lesion	Lésion microlobulée
UCUM		um	micrometer	Micromètre
DCM		112122	Micronodule	Micronodule
SNM3		G-A109	Middle	Milieu
SNM3		G-A109	Middle	Médian
SRT		T-28825	Middle lobe of lung	Lobe moyen du poumon
SRT		T-D3209	Middle zone of lung	Zone moyenne du poumon
DCM		112085	Midlung window	Fenêtre lobaire moyenne
SRT		R-404FA	Mild	faible
DCM		112129	Miliary pattern	Aspect miliaire
SRT		F-01765	Milk of calcium calcification	Lait calcique

UCUM		mm	millimeter	Millimètre
DCM		112179	Minimum Attenuation Coefficient	Coefficient d'atténuation minimum
SRT		G-A194	Minor Axis	Axe secondaire
UCUM		min	minute	Minute
SRT		T-35300	Mitral Valve	Valve atrio-ventriculaire gauche
DCM		111200	MLO Evidence of motion blur	Oblique externe : présence d'un flou cinétique
DCM		111201	MLO Inframammary fold is not open	Oblique externe : sillon sous-mammaire non visible
DCM		111197	MLO Insufficient pectoral muscle	Oblique externe : muscle pectoral insuffisamment visible
DCM		111198	MLO No fat is visualized posterior to fibroglandular tissues	Oblique externe : lame graisseuse rétroglandulaire non visualisée
DCM		111199	MLO Poor separation of deep and superficial breast tissues	Oblique externe : mauvaise séparation des tissus superficiels et profonds
SRT		G-A002	Moderate	Modéré
UCUM	1.4	mo	Month	Mois
SRT		F-01729	More defined	Mieux défini
DCM		112130	Mosaic pattern	Aspect en mosaïque
DCM		112080	Mosaic perfusion	Perfusion en mosaïque
DCM		111210	Motion blur	Flou cinétique
DCM		111210	Motion blur	Artefact de mouvement
LN		18755-9	MR Report	Compte rendu IRM
SNM3		M-84803	Mucinous adenocarcinoma (Colloid carcinoma)	Carcinome (mucineux) colloïde
SRT		G-A443	Multifocal	Multifocal
DCM		111329	Multifocal intraductal carcinoma	Carcinome intracanaulaire multifocal
DCM		111332	Multifocal invasive ductal carcinoma	Carcinome canalaire infiltrant multifocal
DCM		111285	Multiple Intraductal Papillomas	Papillomes multiples
SRT		R-420AE	Muscular	Musculaire
SNM3		M-88250	Myofibroblastoma	Myofibroblastome
SRT		R-41727	Narrow	Étroit
SRT		T-11303	Neck of rib	Col de la côte
SRT		A-30360	Needle	Aiguille
DCM		111144	Needle localization and biopsy	Répérage métallique préopératoire et biopsie-exérèse
SNM3		D0-F035F	Neoplasm of mammary	Tumeur de la peau mammaire



			skin	
SNM3		M-95400	Neurofibroma	Neurofibrome
SNM3		M-95401	Neurofibromatosis	Neurofibromatose
SRT		F-01721	New finding	Nouvel élément
SNM3		T-04100	Nipple	Mamelon
DCM		111297	Nipple Characteristic	Caractéristiques du mamelon
DCM		111205	Nipple not in profile	Le mamelon n'est pas de profil
SNM3		D7-90554	Nipple retraction	Rétraction mamelonnaire
DCM		112177	Nipple ring	Cerclage mammelonnaire
DCM		111286	No abnormality	Pas d'anomalie
DCM		111245	No algorithms succeeded; without findings	Aucun algorithme n'a réussi ; sans élément découvert
DCM		111213	No image	Pas d'image
SRT		F-01723	No significant changes in the finding	Pas de modification significative de l'élément
DCM		110009	No subsequent Workitems	
SRT		R-403A7	Nodular	Nodulaire
DCM		112067	Nodular pattern	Aspect nodulaire
SRT		M-03010	Nodule	Nodule
SNM3		M-95913	Non-Hodgkin's lymphoma	Lymphome non hodgkinien
DCM		111102	Non-lesion	Pas de lésion
DCM		112076	Non-Lesion at Baseline	Anomalie « non lésion » à T0
DCM		112037	Non-lesion Modifier	Modificateur lié à une « non lésion »
DCM		112075	Non-Target Lesion at Baseline	Lésion « non cible » à T0
DCM		112045	Non-Target Lesion Complete Response	Disparition des lésions « non cibles »
DCM		112046	Non-Target Lesion Incomplete Response or Stable Disease	Réponse partielle ou maladie stable sur lésions « non cibles »
DCM		112047	Non-Target Lesion Progressive Disease	Progression sur lésions « non cibles »
DCM		111251	Normal axillary node	Ganglion axillaire normal
DCM		111287	Normal breast tissue	Tissu mammaire normal
DCM		111140	Normal interval follow-up	Intervalle normal de surveillance
SNM3		M-02000	Normal shape	Forme normale
DCM		111244	Not all algorithms succeeded; with findings	Certains algorithmes n'ont pas réussi ; avec élément découvert
DCM		111243	Not all algorithms succeeded; without	Certains algorithmes n'ont pas réussi ; sans élément

			findings	découvert
DCM		111225	Not Attempted	Non traité
DCM		111152	Not for Presentation: Rendering device expected not to present	Pas de présentation
DCM		111038	Number of calcifications	Nombre de calcifications
DCM		121082	Nurse	Infirmière
DCM		111039	Object type	Type d'objet
SRT		G-A472	Oblique	Oblique
SRT		F-01743	Obscured lesion	Lésion masquée
DCM		111322	Occult carcinoma presenting with axillary lymph node metastases	Carcinome occulte révélé par des métastases axillaires
DCM		113000	Of Interest	Interessant
DCM		111290	Oil cyst (fat necrosis cyst)	Cytostéatonécrose kystisée
DCM		111138	Old films for comparison	Clichés antérieurs pour comparaison
DCM		112060	Oligemia	Oligémie
SNM3		G-A103	One-sided	Situé d'un seul côté
DCM		112001	Opacity	Opacité Note: Typically used with projection chest X-ray
DCM		112027	Opacity Descriptor	Descripteur de l'opacité
DCM		112014	Orientation Descriptor	Descripteur de l'orientation
DCM		111040	Original Source	Source originelle
DCM		112053	Osseous	Osseux
DCM		112038	Osseous Modifier	Modificateur lié à une structure osseuse
SRT		F-12100	Ossification	Ossification
SNM3		M-91803	Osteogenic sarcoma	Ostéosarcome
DCM		121102	Other sex	Autre sexe
DCM		111220	Other failure	Autre défaillance
DCM		111175	Other Marker	Autre marqueur
SNM3		G-A112	Outer	En dehors
DCM		111041	Outline	Contours
DCM		111212	Over exposed	Sur-exposé
DCM		111234	Overall Impression / Recommendation Analysis	Analyse de l'Impression / ecommandation globale
SNM3		M-02120	Ovoid shape (Oval)	Forme ovale (Ovale)
SNM3		A-11101	Pacemaker	Stimulateur cardiaque
SNM3		A-10042	Compression paddle	Palette de compression
SNM3		M-85403	Paget's disease,	Maladie de Paget du mamelon

			mammary (of the nipple)	
DCM		112176	Pancreatic stent	Stent pancréatique
SNM3		M-80503	Papillary carcinoma (invasive)	Carcinome papillaire infiltrant
SNM3		M-80502	Papillary carcinoma in-situ	Carcinome papillaire in-situ
SNM3		M-80500	Papilloma	Papillome
DCM		112091	Paraspinal line	Ligne paravertébrale
DCM		112112	Parenchymal band	Bande parenchymateuse
DCM		111223	Partially Succeeded	Succès partiel
DCM		121055	Path	Tracé
DCM		121211	Path length	Longueur du tracé
DCM		111042	Pathology	Pathologie
DCM		111043	Patient Orientation Column	Colonne concernant l'orientation du patient
DCM		111044	Patient Orientation Row	Ligne concernant l'orientation du patient
SRT		T-D2236	Pectoral girdle	Ceinture pectorale
DCM		111045	Pectoral Muscle Outline	Contour du muscle pectoral
SRT		T-14110	Pectoralis major muscle	Muscle grand pectoral
SRT		T-14120	Pectoralis minor muscle	Muscle petit pectoral
SRT		T-11515	Pedicle of vertebra	Pédicule de la vertèbre
DCM		111046	Percent Glandular Tissue	Pourcentage de tissu glandulaire
DCM		112185	Performance of CT for Detection of Pulmonary Embolism in Adults	Le scanner dans les embolies pulmonaires de l'adulte, ACR
DCM		112186	Performance of High-Resolution CT of the Lungs in Adults	Le scanner thoracique haute résolution de l'adulte, ACR
DCM		112035	Performance of Pediatric and Adult Chest Radiography, ACR	Les radiographies thoraciques de l'enfant et de l'adulte, ACR
DCM		112184	Performance of Pediatric and Adult Thoracic CT	Le scanner thoracique de l'enfant et de l'adulte, ACR
DCM		121094	Performing	Réalisateur de l'examen
SRT		T-46210	Pericardiophrenic Artery	Artère péricardo-phrénique
SRT		G-A197	Perimeter	Périmètre
DCM		121057	Perimeter Outline	Délimitation du périmètre
SNM3		G-A111	Peripheral	Périphérique
SRT		G-A111	Peripheral	Périphérique
DCM		111299	Peripheral duct papillomas	Papillomes périphériques
SRT		G-A195	Perpendicular Axis	Axe orthogonal
DCM		112123	Phantom tumor	Image pseudo-tumorale

			(pseudotumor)	
SNM3		M-90201	Phyllodes tumor	Tumeur phyllode
SNM3		M-90203	Phyllodes tumor, malignant	Sarcome phyllode (Cystosarcome phyllode malin)
DCM		121081	Physician	Médecin
SRT		A-12024	Pin	Épingle
SNM3		M-97313	Plasmacytoma	Plasmocytome
SRT		D2-60302	Plate-like atelectasis	Atélectasie plane
SNM3		M-89400	Pleomorphic adenoma	Adénome pléomorphe
DCM		112081	Pleonemia	Hypervascularisation
SRT		T-29000	Pleural structure	Plèvres
SRT		D2-81180	Pneumomediastinum	Pneumomédiastin
SRT		D2-80300	Pneumothorax	Pneumothorax
SRT		R-428E7	Poorly defined	Mal définies
DCM		112141	Poorly demarcated	Mal délimité
DCM		112172	Portacath	Chambre de perfusion implantable
DCM		112011	Positioner Primary Angle	Angle de positionnement primaire
DCM		112012	Positioner Secondary Angle	Angle de positionnement secondaire
DCM		111209	Positioning	Positionnement
DCM		111291	Post reduction mammoplasty	Mammoplastie après réduction
SNM3		G-A120	Postaxial	Postaxial
SNM3		G-A106	Posterior	Postérieur
SNM3		G-A106	Posterior	Postérieur
DCM		112089	Posterior junction line	Ligne médiastinale postérieure
SRT		T-28220	Posterior segment of right upper lobe	Segment postérieur du lobe supérieur droit
DCM		112092	Posterior tracheal stripe	Bande trachéale postérieure
SNM3		G-A182	Posterolateral	Postéro-latéral
SNM3		G-A121	Preaxial	Pré-axial
DCM		111151	Presentation Optional: Rendering device may present	Présentation optionnelle
DCM		111150	Presentation Required: Rendering device is expected to present	Présentation requise
DCM		121069	Previous Finding	Résultat antérieur
DCM		121068	Previous Findings	Résultats antérieurs
DCM		112059	Primary complex	Complexe primaire
DCM		110008	Print	
DCM		121066	Prior Procedure	Description de la procédure

			Descriptions	précédente
DCM		111047	Probability of cancer	Probabilité de cancer
DCM		121065	Procedure Description	Description de la procédure
SNM3		G-A140	Profundis	Profondeur
DCM		112151	Profusion	Profusion
SNM3		F-10310	prone	Procubitus
SRT		A-04000	Prosthesis	Prothèse
SNM3		G-A118	Proximal	Proximal
DCM		111292	Pseudoangiomaticous stromal hyperplasia	Hyperplasie stromale pseudo-angiomateuse
DCM		112068	Pseudoplaque	Pseudo-plaque
SRT		T-44000	Pulmonary artery	Artère pulmonaire
SRT		D3-40230	Pulmonary embolism	Embolie pulmonaire
SRT		T-44100	Pulmonary trunk	Tronc artériel pulmonaire
SRT		T-48500	Pulmonary vein	Veine pulmonaire
SRT		F-01767	Punctate calcification	Calcification punctiforme régulière
DCM		111048	Quadrant location	Localisation du quadrant
DCM		111049	Qualitative Difference	Différence qualitative
DCM		111050	Quality Assessment	Évaluation de la qualité
DCM		110002	Quality Control	
DCM		111051	Quality Control Standard	Standard de contrôle de qualité
DCM		111052	Quality Finding	Critère de qualité
DCM		113010	Quality Issue	Problème de qualité
SNM3		M-78731	Radial scar	Cicatrice radiaire
DCM		121084	Radiographer	Manipulateur (rice)
DCM		112005	Radiographic anatomy	Radio-anatomie
LN		11528-7	Radiology Report	Compte rendu radiologique
SNM3		G-A196	Radius	Rayon
DCM		112022	RECIST	Critères d'évaluation de la réponse tumorale (tumeurs solides)
DCM		121075	Recommendation	Recommandation
DCM		121074	Recommendations	Recommandations
DCM		111053	Recommended Follow-up	Surveillance recommandée
DCM		111054	Recommended Follow-up Date	Date recommandée de surveillance
DCM		111055	Recommended Follow-up Interval	Intervalle recommandé de surveillance
DCM		121097	Recording	Qui fait le compte rendu
SNM3		F-10450	recumbent	Couché

DCM		111338	Recurrent malignancy	Cancer récidivant
DCM		121095	Referring	Médecin référent
SRT		F-01773	Regional calcification distribution	Distribution régionale des calcifications
DCM		121087	Registrar	Secrétaire
DCM		113001	Rejected for Quality Reasons	Rejetées pour des motifs de qualité
SRT		F-0172A	Removal of implant since previous mammogram	Exérèse de la prothèse mammaire depuis la mammographie précédente
DCM		111056	Rendering Intent	Intention d'insertion
DCM		110007	Report Verification	
DCM		121062	Request	Demande
DCM		121096	Requesting	Médecin demandeur
DCM		121086	Resident	Résident
DCM		112020	Response Evaluation	Evaluation de la réponse
DCM		112021	Response Evaluation Method	Méthode d'évaluation de la réponse
DCM		112113	Reticular pattern	Aspect réticulaire
DCM		112065	Reticulonodular pattern	Aspect réticulo-nodulaire
SRT		T-11300	Rib	Côte
DCM		112096	Rib Scalene Tubercle	Tubercule scalénique de la première côte
SNM3		G-A100	Right	Droit
SNM3		G-A102	Right and left	Droit et gauche
SNM3		T-04020	Right breast	Sein droit
SNM3		G-A100	Right lateral	Latéral droit
SNM3		F-10317	right lateral decubitus	Décubitus latéral droit
SRT		T-26100	Right main bronchus	Bronche principale droite
DCM		112093	Right tracheal stripe	Bande paratrachéale droite
SNM3		R-102D3	Rolled Lateral	Roulé externe
SNM3		R-102D4	Rolled Medial	Roulé interne
SNM3		M-02100	Round shape	Ronde
SRT		F-01768	Round shaped calcification	Calcification ronde
SNM3		G-A145	Sagittal	Sagittal
SRT		T-13450	Scalenus anterior muscle	Muscle scalène antérieur
SRT		T-12280	Scapula	Scapula
DCM		112101	Scapular Infraspinatus Fossa	Fosse sous épineuse
DCM		112099	Scapular Spine	Epine de l'omoplate
DCM		112100	Scapular Supraspinatus Fossa	Fosse sus épineuse

SNM3		M-78060	Scar tissue	Tissu cicatriciel
SRT		F-01712	Scattered fibroglandular densities	Opacités fibro-glandulaires éparées
SNM3		M-74220	Sclerosing adenosis	Adénose sclérosante
DCM		111057	Scope of Feature	Champ des caractéristiques
DCM		112054	Secondary pulmonary lobule	Lobule pulmonaire secondaire
SNM3		M-85023	Secretory (juvenile) carcinoma of the breast	Carcinome mammaire sécrétoire (juvénile)
SRT		T-280D0	Segment of lung	Segment du poumon
SRT		G-A137	Segmental	Segmentaire
SRT		F-01774	Segmental calcification distribution	Segmentaires
DCM		111099	Selected region	Région sélectionnée
DCM		111058	Selected Region Description	Description de la région sélectionnée
SNM3		F-10460	semi-erect	Semi-couché
SNM3		F-10316	semi-prone	Semi-procubitus
DCM		112114	Septal line(s)	Ligne(s) septale(s)
DCM		112002	Series Instance UID	Identificateur unique d'instance de série
SNM3		M-36050	Seroma	Lymphocèle
SRT		T-14140	Serratus anterior muscle	Muscle dentelé antérieur
SRT		G-A003	Severe	Sévère
SRT		G-C197	Severity	Gravité
DCM		112124	Shadow	Image
SRT		T-11309	Shaft of rib	Corps de la côte
SNM3		M-020F9	Shape	Forme
DCM		112137	Sharply defined	A limites nettes
DCM		112140	Sharply demarcated	Très nettement délimité
SNM3		G-A186	Short Axis	Petit axe
SNM3		M-84903	Signet ring cell carcinoma	Carcinome à cellules en bague à chaton
DCM		112069	Signet-ring sign	Signe de la bague à châton
DCM		112152	Silhouette sign	Signe de la silhouette
DCM		111296	Silicone granuloma	Granulome au silicone
DCM		111059	Single Image Finding	Élément présent sur une seule image
DCM		112024	Single Image Finding Modifier	Modificateur lié à une anomalie visible sur une seule image
DCM		112008	Site involvement	Site atteint
SNM3		F-103A0	sitting	Assis
DCM		112025	Size Descriptor	Descripteur de la taille

SNM3		D0-00050	Skin lesion	Lésion cutanée
SRT		F-01799	Skin retraction of breast	Rétraction cutanée du sein
SRT		F-0179A	Skin thickening of breast	Épaississement cutané du sein
SRT		R-404A8	Small	Petit
DCM		112125	Small irregular opacities	Petites opacités irrégulières
DCM		112126	Small rounded opacities	Micro-nodules
DCM		112144	Soft tissue	Tissus mous
DCM		111218	Software failure	Défaillance logicielle
SRT		P5-B3402	Spatial collocation analysis	Analyse de colocalisation spatiale
SRT		P5-B3404	Spatial proximity analysis	Analyse de proximité spatiale
DCM		112136	Spiculated	Spiculée
SRT		F-01745	Spiculated lesion	Lésion spiculée
SRT		T-14050	Spinalis muscle	Muscles spinaux
SNM3		M-78190	Spindle cell nodule (tumor)	Nodule (tumeur) à cellules fusiformes
SRT		T-11500	Spine	Rachis
SRT		T-11512	Spinous process of vertebra	Apophyse épineuse de la vertèbre
SNM3		R-102D7	Spot Compression	Compression localisée
SNM3		R-102D7	Spot compression	Compression localisée
DCM		111136	Spot magnification view(s)	Agrandissement localisé
SNM3		M-80703	Squamous cell carcinoma	Carcinome épidermoïde
DCM		111340	Squamous cell carcinoma of the nipple	Carcinome épidermoïde du mamelon
UCUM		cm2	Square centimeter	Centimètre carré
UCUM		um2	Square micrometer	Micromètre carré
UCUM		mm2	Square millimeter	Millimètre carré
DCM		112183	Standard Deviation of Attenuation Coefficient	Ecart-type des coefficients d'atténuation
SNM3		F-10320	standing	En position verticale
SNM3		A-13600	Staple	Agrafe
SRT		T-11221	Sternal angle	Angle sternal
SRT		T-13310	Sternocleidomastoid muscle	Muscle sterno-cleïdo-mastoïdien
SRT		T-11210	Sternum	Sternum
SNM3		F-10390	stooped-over	Penché en avant
DCM		112094	Stripe	Bande
DCM		111060	Study Date	Date de l'étude
DCM		111061	Study Time	Heure de l'étude
SRT		G-A561	Subacute	Subaigu



SRT		F-0178D	Subareolar position	Situation rétroaréolaire
SNM3		G-A172	Subcapsular	Sous-capsulaire
SRT		T-46100	Subclavian artery	Artère subclavière
SRT		T-48330	Subclavian vein	Veine subclavière
SRT		T-14166	Subcostal muscle	Muscle subcostal
DCM		112153	Subpleural	Sous-pleural
DCM		112115	Subpleural line	Ligne sous-pleurale
DCM		112098	Subscapular Fossa	Fosse subscapulaire
SRT		T-13650	Subscapularis muscle	Muscle subscapulaire
DCM		111222	Succeeded	Succès
DCM		111062	Successful Analyses	Analyses réussies
DCM		111063	Successful Detections	Procédures de détection réussies
DCM		111146	Suggestive of malignancy – take appropriate action	Évocateur de malignité, une action appropriée doit être entreprise
DCM		111065	Summary of Analyses	Résumé des analyses
DCM		111064	Summary of Detections	Résumé des procédures de détections
SNM3		G-A139	Superficial	Superficiel
SNM3		G-A116	Superior	Supérieur
SRT		T-116EE	Superior articular facet of axis	Facette articulaire supérieure de l'axis
SRT		T-1153E	Superior articular process of vertebra	Massif articulaire supérieur
SRT		T-46350	Superior phrenic artery	Artère phrénique supérieure
SRT		T-48610	Superior vena cava	Veine cave supérieure
SNM3		R-102D0	superolateral to inferomedial oblique	Supérolatéral vers inféromédial oblique
SNM3		F-10340	supine	Décubitus
SRT		T-13610	Supraspinatus muscle	Muscle supraépineux
SNM3		T-11218	Suprasternal notch	Creux sus-sternal
SNM3		G-A168	Surface	Surface
SNM3		A-13510	Suture material	Matériel de suture
SRT		G-A572	Systemic	Systémique
SRT		T-4000E	Systemic vascular structure	Structure vasculaire systémique
SNM3		R-102C2	Tangential	Tangentiel
DCM		112162	Target	« cible »
DCM		111155	Target content items are related contra-laterally	Les items de contenu sont situés de façon controlatérale
DCM		111154	Target content items are related spatially	Les items de contenu sont reliés spatialement
DCM		111153	Target content items are	Les items de contenu sont

			related temporally	reliés temporellement
DCM		112074	Target Lesion at Baseline	Lésion « cible » à T0
DCM		112041	Target Lesion Complete Response	Réponse complète sur lésions « cibles »
DCM		112042	Target Lesion Partial Response	Réponse partielle sur lésions « cibles »
DCM		112043	Target Lesion Progressive Disease	Progression de la maladie sur lésions « cibles »
DCM		112044	Target Lesion Stable Disease	Maladie stable sur lésions « cibles »
DCM		111194	Technical factors missing	Paramètres techniques absents
DCM		121083	Technologist	Technicien
SRT		P5-B3406	Temporal correlation	Corrélation temporelle
SRT		T-13640	Teres major muscle	Muscle grand rond
SRT		T-13630	Teres minor muscle	Muscle petit rond
DCM		112010	Texture Descriptor	Descripteur de la texture
SRT		T-C6510	Thoracic Duct	Canal thoracique
DCM		112032	Threshold Attenuation Coefficient	Valeur de coefficient d'atténuation seuil
SNM3		D3-87780	Thrombophlebitis of breast (Mondor's disease)	Thrombophlébite du sein (maladie de Mondor)
SRT		T-C8000	Thymus Gland	Thymus
SRT		T-46130	Thyrocervical trunk	Tronc thyro-bicervico-scapulaire
SRT		T-B6000	Thyroid	Thyroïde
DCM		112133	Too small	Trop petit
SRT		T-32423	Trabeculae carnae	Piliers du ventricule
SRT		F-01798	Trabecular thickening of breast	Épaississement trabéculaire du sein
SRT		T-25000	Trachea	Trachée
SRT		P1-26100	Tracheotomy	Trachéotomie
DCM		112039	Tracking Identifier	Identifiant d'anomalie
DCM		112040	Tracking Unique Identifier	Identifiant unique d'anomalie
DCM		112116	Tramline shadow	Image en rail
DCM		110006	Transcription (task)	
DCM		110012	Transcription (type of output)	
SNM3		G-A117	Transverse	Transverse
SRT		T-11513	Transverse process of vertebra	Apophyse transverse de la vertèbre
SRT		T-141A5	Transversus thoracis	Muscle transverse du thorax

SRT		T-14171	Trapezius muscle	Muscle trapèze
DCM		112127	Tree-in-bud sign	Signe de l'arbre en bourgeons
SNM3		F-10348	Trendelenburg	Trendelenburg
SRT		T-35100	Tricuspid Valve	Valve atrioventriculaire droite
SRT		T-11304	Tubercle of rib	Tubercule de la côte
SNM3		M-82113	Tubular adenocarcinoma	Carcinome tubuleux
SNM3		M-82110	Tubular adenoma	Adénome tubuleux
SRT		F-01797	Tubular density	Opacité tubulaire
DCM		112117	Tubular shadow	Image tubulée
DCM		112009	Type of Content	Type de contenu
SRT		P5-B0099	Ultrasound procedure	Procédure échographique
LN		18760-9	Ultrasound Report	Compte rendu d'échographie
DCM		111211	Under exposed	Sous-exposé
SNM3		G-A103	Unilateral	Unilatéral
SRT		G-A103	Unilateral	Unilatéral
DCM		111221	Unknown failure	Défaillance inconnue
DCM		111176	Unspecified	Non spécifié
DCM		112187	Unspecified method of calculation	Méthode de calcul non spécifiée
DCM		111235	Unusable — Quality renders image unusable	Inexploitable — La qualité rend l'image inexploitable
SNM3		G-A116	Upper	En haut
SRT		T-D4001	Upper abdomen	Abdomen supérieur
SRT		T-04002	Upper inner quadrant of breast	Quadrant supéro-interne du sein
SNM3		T-04002	Upper inner quadrant of breast, NOS	Quadrant supéro-interne du sein, SAI
SRT		T-28820	Upper lobe of lung	Lobe supérieur du poumon
SRT		T-04004	Upper outer quadrant of breast	Quadrant supéro-externe du sein
SNM3		T-04004	Upper outer quadrant of breast, NOS	Quadrant supéro-externe du sein, SAI
SRT		D-3208	Upper zone of lung	Zone supérieure du poumon
SRT		A-11C08	Ureteric stent	Stent urétral
DCM		111236	Usable — Does not meet the quality control standard	Exploitable — Ne répond pas aux standards de contrôle de qualité
DCM		111237	Usable — Meets the quality control standard	Exploitable — Répond aux standards de contrôle de qualité
SRT		F-0176B	Vascular calcification	Calcification vasculaire
DCM		112077	Vasoconstriction	Vasoconstriction
DCM		112078	Vasodilation	Vasodilatation
SRT		A-14611	Vena cava filter	Filtre cave

SNM3		G-A105	Ventral	Ventral
SRT		T-32400	Ventricle	Ventricule
DCM		121098	Verifying	Qui vérifie
SRT		T-11510	Vertebra	Vertèbre
SRT		T-45700	Vertebral artery	Artère vertébrale
SRT		T-1151F	Vertebral canal	Canal vertébral
SRT		T-11531	Vertebral foramen	Foramen intervertébral
DCM		112097	Vertebral Intervertebral Notch	Trou des apophyses transverses cervicales
SNM3		G-A144	Vertical	Vertical
SRT		G-A144	Vertical	Vertical
DCM		111066	Vertical Pixel Spacing	Espacement vertical des pixels
DCM		112132	Very small	Très petit
DCM		111178	View and Laterality Marker does not have both view and laterality	Le marquage n'indique ni l'incidence ni le côté
DCM		111183	View and Laterality Marker is incorrect	Le marquage est incorrect
DCM		111177	View and Laterality Marker is missing	Marquage absent
DCM		111180	View and Laterality Marker is not near the axilla	Le marquage n'est pas près de l'aisselle
DCM		111184	View and Laterality Marker is off image	Le marquage est en dehors du film
DCM		111182	View and Laterality Marker is partially obscured	Le marquage est partiellement masqué
DCM		111181	View and Laterality Marker overlaps breast tissue	Le marquage chevauche le sein
DCM		111298	Virginal hyperplasia	Hypertrophie juvénile
SNM3		G-D705	Volume	Volume
DCM		121216	Volume estimated from single 2D region	Volume estimé à partir d'une seule région 2D
DCM		121217	Volume estimated from three or more non-coplanar 2D regions	Volume estimé à partir de trois régions 2D non coplanaires ou plus
DCM		121218	Volume estimated from two non-coplanar 2D regions	Volume estimé à partir de deux régions 2D non coplanaires
DCM		121219	Volume of bounding three dimensional region	Volume d'une région tridimensionnelle de forme quelconque
DCM		121220	Volume of circumscribed sphere	Volume de la sphère circonscrite
DCM		121221	Volume of ellipsoid	Volume d'un ellipsoïde

DCM		121222	Volume of sphere	Volume d'une sphère
DCM		112056	Volume scoring method	Score de calcification coronaire basé sur le volume de chaque calcification
UCUM	1.4	wk	Week	Semaine
SRT		R-40771	Well defined	Bien définie
DCM		112139	Well demarcated	Bien délimité
DCM		112029	WHO	OMS
SNM3		G-A220	Width	Largeur
DCM		112026	Width Descriptor	Descripteur de la largeur
SRT		T-11227	Xiphoid process of sternum	Appendice xiphoïde
UCUM	1.4	a	Year	Année

Note: In the translation of (113006, DCM, "For Therapy"), therapy could be translated as « thérapeutique » as well as « traitement ». There is an issue with the word « traitement » because it is the same word used for image processing. To avoid any ambiguity we have chosen the word « thérapeutique » which is less used in common language.

The following table provides a mapping of pathology codes used in DICOM, to ADICAP (L'association pour le Développement de l'Informatique en Anatomie et Cytologie Pathologiques).

<b>Coding Scheme Designator</b>	<b>Coding Scheme Version</b>	<b>Code Value</b>	<b>Code Meaning French Language</b>	<b>Equivalent ADICAP Code</b>
SNM3		M-55160	(Tumeur) amyloïde	5310
SNM3		M-83240	Adénolipome	A0L2
DCM		111258	Adénome ductal	A0B2
SNM3		M-82040	Adénome lactant	A0M2
SNM3		M-89400	Adénome pléomorphe	A0R8
SNM3		M-82110	Adénome tubuleux	A0P1
DCM		111250	Adénomyoépithéliome	A0A0
SNM3		M-74200	Adénose	6772
DCM		111284	Adénose microglandulaire	6772
SNM3		M-74220	Adénose sclérosante	6772
SNM3		M-88610	Angiolipome	L0P1
SNM3		M-76100	Angiomatose	V0C0
SNM3		M-91203	Angiosarcome (hémangiosarcome)	V7A0
SNM3		M-84803	Carcinome (mucineux) colloïde	A7N4
SNM3		M-82003	Carcinome adénoïde kystique (cylindrome)	A7X6
SNM3		M-84013	Carcinome apocrine	A7K6
DCM		111307	Carcinome basocellulaire du	B7A0

<b>Coding Scheme Designator</b>	<b>Coding Scheme Version</b>	<b>Code Value</b>	<b>Code Meaning French Language</b>	<b>Equivalent ADICAP Code</b>
			mamelon	
SNM3		M-85003	Carcinome canalaire infiltrant	A7A0
DCM		111340	Carcinome épidermoïde du mamelon	E7A0
DCM		111341	Carcinome intracanaulaire	A5B2
SNM3		D7-F0A02	Carcinome lobulaire in situ mammaire	A5B0
SNM3		M-85203	Carcinome lobulaire infiltrant	A7B1
SNM3		M-85023	Carcinome mammaire sécrétoire (juvénile)	A7N7
SNM3		M-85103	Carcinome médullaire	A7X2
SNM3		M-85733	Carcinome métaplasique	A7W0
SNM3		M-80503	Carcinome papillaire infiltrant	A7C6
SNM3		M-82113	Carcinome tubuleux	A7F0
SNM3		M-92200	Chondrome	C0A0
SNM3		M-92203	Chondrosarcome	C7A0
SNM3		M-78731	Cicatrice radiaire	6773
SNM3		D7-90434	Cytostéatonécrose mammaire	5230
SNM3		M-78800	Fibromatose	F0F0
SNM3		M-90100	Fibroadénome	A0P2
SNM3		M-90300	Fibroadénome juvénile	A0P2
SNM3		M-88103	Fibrosarcome	F7A0
SNM3		D7-90370	Galactophorite ectasiant mammaire (ectasie canalaire mammaire)	6546
SNM3		D7-90420	Gynécomastie	6551
SNM3		M-75500	Hamartome	D0S0
SNM3		M-91200	Hémangiome	V0A0
SNM3		D3-F0620	Hémangiome sous-cutané non parenchymateux	V0A0
SNM3		M-91220	Hémangiome veineux	VOA8
SNM3		M-91501	Hémangiopéricytome	V0K0
SNM3		M-72170	Hyperplasie canalaire	6712
SNM3		M-72175	Hyperplasie intracanaulaire atypique	6830
SNM3		M-72105	Hyperplasie lobulaire atypique	6840
SNM3		D7-90428	Hyperplasie lobulaire mammaire	6721
DCM		111298	Hypertrophie juvénile	6080
SNM3		D7-90452	Infarctus mammaire	4710
SNM3		M-40000	Infection	7140
SNM3		D7-90360	Kyste du sein	6544

<b>Coding Scheme Designator</b>	<b>Coding Scheme Version</b>	<b>Code Value</b>	<b>Code Meaning French Language</b>	<b>Equivalent ADICAP Code</b>
SNM3		M-88900	Léiomyome	L0A0
SNM3		M-88903	Léiomyosarcome	L7A0
SNM3		M-88500	Lipome	L0L0
SNM3		M-95913	Lymphome non hodgkinien	K7G0
SNM3		M-96503	Maladie de Hodgkin	K7A0
SNM3		M-85403	Maladie de Paget du mamelon	A7B7
DCM		111259	Mastopathie diabétique	5010
DCM		111334	Mélanome malin du mamelon	M7A0
SNM3		M-95400	Neurofibrome	N0L0
SNM3		M-91803	Ostéosarcome	Q7A0
SNM3		M-80500	Papillome	A0P4 (unique), A0S4 (multiple)
SNM3		M-97313	Plasmocytome	K7M0
SNM3		M-44140	Réaction à corps étranger	7440
SNM3		M-90203	Sarcome phyllode (Cystosarcome phyllode malin)	A7P6
SNM3		M-95800	Tumeur à cellules granuleuses	X0H4
SNM3		M-90201	Tumeur phyllode	A0P6

**Annex F Japanese Translations of Selected Codes used in the DCMR (Normative)**

<b>Coding Scheme Designator</b>	<b>Coding Scheme Version</b>	<b>Code Value</b>	<b>Code Meaning English Language</b>	<b>Code Meaning Japanese Language</b>
BI	3.0	II.AC.a	0 - Need additional imaging evaluation	0 - 追加撮影が必要
BI	3.0	II.AC.b.1	1 - Negative	1 - 異常なし
SRT		F-01781	1 o'clock position	1時
SRT		F-0178A	10 o'clock position	1 0時
SRT		F-0178B	11 o'clock position	1 1時
SRT		F-0178C	12 o'clock position	1 2時
BI	3.0	II.AC.b.2	2 - Benign Finding	2 - 良性所見
SRT		F-01782	2 o'clock position	2時
BI	3.0	II.AC.b.3	3 - Probably Benign Finding - short interval follow-up	3 - 良性—しかし悪性を否定できず所見—短い間隔での経過観察が必要
SRT		F-01783	3 o'clock position	3時
BI	3.0	II.AC.b.4	4 - Suspicious abnormality, biopsy should be considered	4 - 悪性の疑い、生検を考慮
SRT		F-01784	4 o'clock position	4時
BI	3.0	II.AC.b.5	5 - Highly suggestive of malignancy, take appropriate action	5 - 悪性、適切な処置が必要
SRT		F-01785	5 o'clock position	5時
SRT		F-01786	6 o'clock position	6時
SRT		F-01787	7 o'clock position	7時
SRT		F-01788	8 o'clock position	8時
SRT		F-01789	9 o'clock position	9時
DCM		111135	Additional projections	追加撮影 (P)
SNM3		M-82003	Adenoid cystic carcinoma	嚢胞腺癌
SNM3		M-83240	Adenolipoma	腺脂肪腫
SNM3		M-89830	Adenomyoepithelioma	腺筋上皮腫
SNM3		M-74200	Adenosis	腺症
DCM		111001	Algorithm Name	アルゴリズム 名
DCM		111002	Algorithm Parameters	アルゴリズム・パラメータ
DCM		111003	Algorithm Version	アルゴリズム・バージョン (版番号)



<b>Coding Scheme Designator</b>	<b>Coding Scheme Version</b>	<b>Code Value</b>	<b>Code Meaning English Language</b>	<b>Code Meaning Japanese Language</b>
DCM		111242	All algorithms succeeded; with findings	全てのアルゴリズムが成功； 所見あり
DCM		111241	All algorithms succeeded; without findings	全てのアルゴリズムが成功； 所見なし
SRT		F-01711	Almost entirely fat	脂肪性
SRT		F-0176C	Amorphous calcification	淡く不明瞭な
SNM3		M-55160	Amyloid (tumor)	アミロイド腫瘍
DCM		111004	Analysis Performed	解析済みの
SNM3		M-88610	Angiolipoma	血管脂肪腫
SNM3		M-76100	Angiomatosis	血管腫症
SNM3		M-91203	Angiosarcoma	血管肉腫
SNM3		G-A105	Anterior	前方の
DCM		111141	Any decision to biopsy should be based on clinical assessment	臨床評価に基づいた生検の適 応決定 (D)
SNM3		M-84013	Apocrine adenocarcinoma	アポクリン癌
SRT		F-01795	Architectural distortion of breast	乳房の構築の乱れ
DCM		111215	Artifact(s) other than grid or detector artifact	検出器のアーチファクト以外 のアーチファクト
DCM		111005	Assessment Category	カテゴリー評価
SRT		F-01793	Asymmetric breast tissue	非対称性乳房組織
SRT		P5-B3412	Asymmetric breast tissue analysis	非対称性乳房組織解析
SNM3		F-8A063	Asynchronous involution of breast	乳房の非同期性退縮
SNM3		M-72175	Atypical intraductal hyperplasia	異型性乳管過形成；異型性乳 管内過形成
SNM3		M-72105	Atypical lobular hyperplasia	異型性小葉過形成
BI	3.0	I.E.6	Axillary adenopathy	腋窩リンパ節腫大
SRT		F-0178E	Axillary tail position	腋窩稜：乳腺の腋窩稜（C'領域）
DCM		111307	Basal cell carcinoma of the nipple	乳頭の基底細胞癌
SNM3		A-32475	BB shot (Lead Pellet)	鉛小球；BBマーカー
DCM		111143	Biopsy should be considered	要生検 (B)

<b>Coding Scheme Designator</b>	<b>Coding Scheme Version</b>	<b>Code Value</b>	<b>Code Meaning English Language</b>	<b>Code Meaning Japanese Language</b>
SNM3		T-04080	Both breasts	両側：両側乳房
SRT		F-01710	Breast composition	乳房の構成
SRT		P5-B3414	Breast composition analysis	乳房の構成の解析
DCM		111100	Breast geometry	乳房の形状
SNM3		D7-90428	Breast lobular hyperplasia	小葉過形成：乳腺小葉過形成
DCM		111007	Breast Outline including Pectoral Muscle Tissue	胸筋組織を含む乳房の輪郭
SNM3		A-32110	Bullet	マーカー
DCM		111017	CAD Processing and Findings Summary	CAD処理と所見の要約
SRT		F-01775	Calcification Cluster	石灰化の集簇
DCM		111008	Calcification Distribution	石灰化の分布
DCM		111009	Calcification Type	石灰化のタイプ
SRT		F-01769	Calcified skin of breast	皮膚；乳房の皮膚
DCM		111304	Carcinoma in children	小児乳癌
DCM		111305	Carcinoma in ectopic breast	副乳の乳癌
DCM		111310	Carcinoma in pregnancy and lactation	妊娠・授乳期乳癌
SNM3		D7-F0902	Carcinoma in situ of male breast	男性乳癌
DCM		111306	Carcinoma with endocrine differentiation	内分泌分化を伴う癌
SNM3		M-85733	Carcinoma with metaplasia	化生を伴う癌
SNM3		A-26800	Catheter	カテーテル
DCM		111203	CC Nipple not centered on image	頭尾方向撮影 乳頭が画像の中央にない
DCM		111202	CC Not all medial tissue visualized	頭尾方向撮影 内側組織が十分見えていない
DCM		111204	CC Posterior nipple line does not measure within 1 cm of MLO	頭尾方向撮影 乳頭後方線が内外斜位方向の 1 c m以内に計測できない
DCM		111010	Center	中心部
SRT		F-0178F	Central portion of breast position	中央部：乳腺の中央部
DCM		111011	Certainty of Feature	特徴の確信度
DCM		111012	Certainty of Finding	所見の確信度
DCM		111013	Certainty of Impression	インプレッションの確信度

Coding Scheme Designator	Coding Scheme Version	Code Value	Code Meaning English Language	Code Meaning Japanese Language
SNM3		M-92200	Chondroma	軟骨腫
SNM3		M-92203	Chondrosarcoma	軟骨肉腫
SRT		F-01741	Circumscribed lesion	境界明瞭平滑
SNM3		A-12062	Clip	クリップ
DCM		111014	Clockface or region	時計表示あるいは領域
SRT		F-01761	Coarse (popcorn-like) calcification	粗大 (ポップコーン状)
DCM		111195	Collimation too close to breast	コリメーションが乳房に近すぎる
SNM3		A-1044	Collimator	コリメータ
DCM		111015	Composite Feature	乳房の構成の特徴
DCM		111016	Composite type	乳房の構成のタイプ
DCM		111018	Content Date	記録日
DCM		111019	Content Time	記録時間
SNM3		C-B0300	Contrast agent NOS	造影剤
SNM3		D7-90360	Cyst of breast	嚢胞：乳腺嚢胞
DCM		111147	Cytologic analysis	細胞診 (Y)
DCM		111193	Date sticker is missing	日付けステッカーがない
UCUM	1.4	d	Day	日
SRT		F-01727	Decrease in number of calcifications	石灰化の数の減少
SRT		M-02530	Decrease in size	サイズの縮小
SRT		F-01796	Mammography breast density	乳房画像の濃度
DCM		111020	Depth	深さ (三次元表示の奥行き)
DCM		111021	Description of Change	変化の記載
DCM		111022	Detection Performed	検出済みの
DCM		111214	Detector artifact(s)	検出器のアーチファクト
DCM		111259	Diabetic fibrous mastopathy	糖尿病性乳腺症
SRT		F-017B3	Difference in location	部位
SRT		F-017B7	Difference in margin	辺縁
SRT		F-017B5	Difference in number of calcifications	石灰化の数
SRT		F-017B2	Difference in opacity	濃度
SRT		F-017B6	Difference in shape	形状
SRT		F-017B1	Difference in size	大きさ
SRT		F-017B4	Difference in spatial	空間的近接判定

Coding Scheme Designator	Coding Scheme Version	Code Value	Code Meaning English Language	Code Meaning Japanese Language
			proximity	
SRT		F-017B8	Difference in symmetry	対称性
DCM		111023	Differential Diagnosis/Impression	鑑別診断/インプレッション
SRT		F-01770	Diffuse calcification distribution	びまん性/散在性
DCM		111258	Ductal adenoma	乳管腺腫
SNM3		M-72170	Ductal hyperplasia, Usual	乳管過形成；乳管内過形成
SRT		P5-40060	Mammary ductogram	乳房造影 (G)
SRT		F-01762	Dystrophic calcification	異栄養性；異栄養性石灰化
SRT		F-01763	Eggshell calcification	卵殻状
DCM		111217	Electrical failure	電気系の故障
SRT		F-01752	Equal density (isodense) lesion	等濃度
SRT		F-01714	Extremely dense	高濃度
DCM		111224	Failed	失敗
DCM		111024	Failed Analyses	解析の失敗
DCM		111025	Failed Detections	検出の失敗
SRT		F-01754	Fat containing (radiolucent) lesion	脂肪濃度を含む (X線透亮度)
SNM3		D7-90434	Fat necrosis of breast	脂肪壊死：乳房の脂肪壊死
DCM		111159	Feature detected on images from multiple modalities	多数の検査法で検出される特徴
DCM		111158	Feature detected on multiple images	多数の画像で検出される特徴
DCM		111157	Feature detected on only one of the images	1 画像でのみ検出される特徴
DCM		111156	Feature detected on the only image	画像のみで検出される特徴
SNM3		M-90100	Fibroadenoma	線維腺腫
DCM		111263	Fibroadenomatoid hyperplasia	線維腺腫様過形成：腺線維筋腫様過形成
SNM3		M-78800	Fibromatosis	線維腫症
SNM3		M-88103	Fibrosarcoma	線維肉腫
DCM		111072	Finding partially removed	部分的に消失した所見
SRT		F-0176D	Fine, linear (casting) calcification	微細線状
SRT		F-0176E	Fine, linear, branching	微細線状分枝状

Coding Scheme Designator	Coding Scheme Version	Code Value	Code Meaning English Language	Code Meaning Japanese Language
			(casting) calcification	
DCM		111191	Flash doesn't include cassette/screen/detector identification	患者情報等欄にカセット/スクリーン/検出器名がない
DCM		111188	Flash doesn't include date of examination	患者情報等欄に検査日がない
DCM		111189	Flash doesn't include facility name and location	患者情報等欄に施設名と所在地がない
DCM		111192	Flash doesn't include mammography unit identification	患者情報等欄に乳房撮影装置名がない
DCM		111187	Flash doesn't include patient name and additional patient id	患者情報等欄に患者の氏名および追加情報がない
DCM		111190	Flash doesn't include technologist identification	患者情報等欄に技師名がない
DCM		111186	Flash is illegible, does not fit, or is lopsided	患者情報等欄が読みにくい、大きさがあっていない、あるいは傾いている
DCM		111185	Flash is not near edge of film	患者情報等欄がフィルムの端にない
SRT		F-01792	Focal asymmetric breast tissue	局所性非対称性乳房組織
SRT		P5-B3410	Focal asymmetric density analysis	局所性非対称性陰影
DCM		111142	Follow-up at short interval (1-11 months)	短期間での経過観察 (1 - 11ヶ月) (F)
SNM3		M-44140	Foreign body (reaction)	異物反応
SNM3		M-83153	Glycogen-rich carcinoma	グリコーゲンに富む癌
SNM3		M-95800	Granular cell tumor	顆粒細胞腫
DCM		111208	Grid artifact(s)	グリッドのアーチファクト
SRT		F-01772	Grouped calcification distribution	集簇性
SNM3		D7-90420	Gynecomastia	女性化乳房
SNM3		M-75500	Hamartoma	過誤腫
SNM3		M-91200	Hemangioma	血管腫
SNM3		D3-F0620	Hemangioma of subcutaneous tissue	非実質性皮下組織血管腫
SNM3		M-91220	Hemangioma - venous	静脈性血管腫
SNM3		M-91501	Hemangiopericytoma	血管周皮腫
SRT		F-0176F	Heterogeneous	不均一なあるいは多形性の

Coding Scheme Designator	Coding Scheme Version	Code Value	Code Meaning English Language	Code Meaning Japanese Language
			calcification	
SRT		F-01713	Heterogeneously dense	不均一高濃度
SRT		F-01751	High density lesion	高濃度
DCM		111145	Histology using core biopsy	コア針生検 (H)
SNM3		M-96503	Hodgkin's disease (lymphoma)	ホジキン病
DCM		111026	Horizontal Imager Pixel Spacing	水平方向ピクセル間隔
SNM3		A-16016	ID Plate	IDプレート
DCM		111027	Image Laterality	画像の左右差
DCM		111028	Image Library	画像ライブラリ
DCM		111101	Image Quality	画像の品質
SRT		P5-B3408	Image quality analysis	画像の品質解析
DCM		111029	Image Quality Rating	画質のランク付
DCM		111030	Image Region	画像領域
DCM		111031	Image View	画像表示用符号変換系列
DCM		111032	Image View Modifier	画像表示用符号系列
SNM3		A-04010	Implant	インプラント
SRT		F-0172B	Implant revised since previous mammogram	インプラントの修正
DCM		111033	Impression Description	インプレッションの記載
DCM		111196	Inadequate compression	圧迫不良
DCM		111219	Inappropriate image processing	現像機の故障
SRT		F-01726	Increase in number of calcifications	石灰化の数の増加
SRT		M-02520	Increase in size	サイズの増大
SRT		F-01744	Indistinct lesion	境界不明瞭
SRT		F-01776	Individual Calcification	個々の石灰化
DCM		111233	Individual Impression / Recommendation Analysis	個々のインプレッション／推奨の解析
DCM		111034	Individual Impression/Recommendation	個々のインプレッション／推奨
SNM3		D7-90452	Infarction of breast	梗塞：乳腺の梗塞
SNM3		M-40000	Inflammation	感染
SNM3		M-85303	Inflammatory carcinoma	炎症性乳癌
DCM		111206	Insufficient implant	インプラントの圧排不十分

Coding Scheme Designator	Coding Scheme Version	Code Value	Code Meaning English Language	Code Meaning Japanese Language
			displacement incorrect	
DCM		111341	Intraductal carcinoma, high grade	非浸潤性乳管癌 : D C I S
SNM3		T-C4351	Intra-mammary lymph node	乳房内リンパ節
SNM3		M-82013	Invasive cribriform carcinoma	浸潤性篩状癌
SNM3		M-85003	Infiltrating duct carcinoma	浸潤性乳管癌
SNM3		M-85203	Invasive lobular carcinoma	浸潤性小葉癌
SNM3		G-A402	Irregular	不整形
SNM3		A-1016B	J Wire	Jワイヤー
SNM3		M-90300	Juvenile fibroadenoma	若年性線維腺腫
DCM		111277	Juvenile papillomatosis	若年性乳頭腫症
SNM3		M-82040	Lactating adenoma	授乳性腺腫
SRT		F-01764	Large rod-like calcification	大きな桿状
SNM3		T-04030	Left breast	左 : 左乳房
SNM3		M-88900	Leiomyoma	平滑筋腫
SNM3		M-88903	Leiomyosarcoma	平滑筋肉腫
DCM		111035	Lesion Density	病変の濃度
SRT		F-01728	Less defined	より不明瞭になってきた
DCM		111318	Leukemic infiltration	白血病浸潤
SRT		F-01771	Linear calcification distribution	線状
SNM3		M-83143	Lipid-rich (lipid-secreting) carcinoma	脂肪に富む (脂質分泌) 癌
SNM3		M-88500	Lipoma of the breast	脂肪腫
SNM3		G-A640	Lobular	分葉状
SNM3		D7-F0A02	Lobular carcinoma in situ of breast	非浸潤性小葉癌 : L C I S
SRT		F-01753	Low density (not containing fat) lesion	低濃度 (脂肪を含まない)
SRT		T-04003	Lower inner quadrant of breast	内下部 : 乳房の内下部 1 / 4 (B領域)
SRT		T-04005	Lower outer quadrant of breast	外下部 : 乳房の外下部 1 / 4 (D領域)
SRT		F-01766	Lucent-centered calcification	中心透亮性
SNM3		R-102D6	Magnification views	拡大撮影 (M)

Coding Scheme Designator	Coding Scheme Version	Code Value	Code Meaning English Language	Code Meaning Japanese Language
DCM		111334	Malignant melanoma of nipple	乳頭の悪性黒色腫
SNM3		D7-90370	Mammary duct ectasia	乳管拡張症
SRT		F-01791	Mammographic breast mass	腫瘍
DCM		111036	Mammography CAD Report	マンモグラフィCADのレポート
DCM		111238	Mammography Quality Control Manual 1999, ACR	マンモグラフィ品質管理マニュアル1999, ACR
DCM		111037	Margins	辺縁
DCM		111216	Mechanical failure	機械の故障
SNM3		M-85103	Medullary carcinoma	髄様癌
SNM3		J-83250	Metal (Lead) Marker	鉛マーカー
DCM		111284	Microglandular adenosis	微小腺管腺症
SRT		F-01742	Microlobulated lesion	微細分葉状
SNM3		G-A109	Middle	中央の
SRT		F-01765	Milk of calcium calcification	石灰乳
DCM		111200	MLO Evidence of motion blur	内外斜位方向撮影 体動によるブレがある
DCM		111201	MLO Inframammary fold is not open	内外斜位方向撮影 乳房下溝が開いていない
DCM		111197	MLO Insufficient pectoral muscle	内外斜位方向撮影 胸筋の描出が不十分
DCM		111198	MLO No fat is visualized posterior to fibroglandular tissues	内外斜位方向撮影 乳腺後隙の脂肪が見られない
DCM		111199	MLO Poor separation of deep and superficial breast tissues	内外斜位方向撮影 乳房組織の深部および表在乳腺の分離が不良である
UCUM	1.4	mo	Month	月
SRT		F-01729	More defined	より明瞭になってきた
DCM		111210	Motion blur	患者の体動
SNM3		M-84803	Mucinous adenocarcinoma (Colloid carcinoma)	粘液癌
DCM		111283	Myofibroblastoma	筋線維芽腫
DCM		111144	Needle localization and biopsy	針留置による位置決めと生検(L)
SNM3		D0-F035F	Neoplasm of mammary	乳房皮膚の新生物



Coding Scheme Designator	Coding Scheme Version	Code Value	Code Meaning English Language	Code Meaning Japanese Language
			skin	
SNM3		M-95400	Neurofibroma	神経線維腫
SRT		F-01721	New finding	新しい所見
SNM3		T-04100	Nipple	乳頭
SNM3		D7-90554	Nipple retraction	乳頭陥凹
DCM		111245	No algorithms succeeded; without findings	全てのアルゴリズムが失敗； 所見なし
DCM		111213	No image	画像なし
SRT		F-01723	No significant changes in the finding	所見上、著変なし
SNM3		M-95913	Non-Hodgkin's lymphoma	非ホジキンリンパ腫
DCM		111102	Non-lesion	病変がない
DCM		111140	Normal interval follow-up	通常間隔での経過観察 (N)
SNM3		M-02000	Normal shape	正常乳頭
DCM		111244	Not all algorithms succeeded; with findings	全てのアルゴリズムが成功した訳ではない；所見あり
DCM		111243	Not all algorithms succeeded; without findings	全てのアルゴリズムが成功した訳ではない；所見なし
DCM		111225	Not Attempted	未施行
DCM		111152	Not for Presentation: Rendering device expected not to present	提示の必要なし：表示装置提示の必要なし
DCM		111038	Number of calcifications	石灰化の数
DCM		111039	Object type	対象のタイプ
SRT		F-01743	Obscured lesion	評価困難
DCM		111322	Occult carcinoma presenting with axillary lymph node metastases	腋窩リンパ節転移を伴う潜伏癌
DCM		111138	Old films for comparison	比較のための以前のフィルム (0)
DCM		111040	Original Source	情報源
SNM3		M-91803	Osteogenic sarcoma	骨肉腫
DCM		111220	Other failure	他の故障
DCM		111175	Other Marker	他のマーカー
DCM		111041	Outline	輪郭
DCM		111212	Over exposed	露光過多
DCM		111234	Overall Impression / Recommendation Analysis	全体のインプレッション／推奨の解析

Coding Scheme Designator	Coding Scheme Version	Code Value	Code Meaning English Language	Code Meaning Japanese Language
			Analysis	
SNM3		M-02120	Ovoid shape (Oval)	楕円形
SNM3		A-11101	Pacemaker	ペースメーカー
SNM3		A-10042	Compression paddle	圧縮パドル
SNM3		M-85403	Paget's disease, mammary (of the nipple)	乳頭のパジェット病
SNM3		M-80503	Papillary carcinoma (invasive)	浸潤性乳頭癌
SNM3		M-80500	Papilloma	乳頭腫
DCM		111223	Partially Succeeded	部分的成功
DCM		111042	Pathology	病理
DCM		111043	Patient Orientation Column	患者情報 行
DCM		111044	Patient Orientation Row	患者情報 列
DCM		111045	Pectoral Muscle Outline	胸筋輪郭
DCM		111046	Percent Glandular Tissue	乳腺組織の割合 (%)
SNM3		M-90201	Phyllodes tumor	良性葉状腫瘍
SNM3		M-90203	Phyllodes tumor, malignant	悪性葉状腫瘍
SNM3		M-97313	Plasmacytoma	形質細胞腫
SNM3		M-89400	Pleomorphic adenoma	混合腫瘍 (多形腺腫)
DCM		111209	Positioning	ポジショニング
SNM3		G-A106	Posterior	後方の
DCM		111151	Presentation Optional: Rendering device may present	提示はオプションである : 表示装置の提示は自由
DCM		111150	Presentation Required: Rendering device is expected to present	提示が必要である : 表示装置の提示必要
DCM		111047	Probability of cancer	癌の可能性
DCM		111292	Pseudoangiomatous stromal hyperplasia	偽血管腫様間質過形成
SRT		F-01767	Punctate calcification	点状
DCM		111048	Quadrant location	位置表示 (四分の一円)
DCM		111049	Qualitative Difference	質的相違
DCM		111050	Quality Assessment	品質評価
DCM		111051	Quality Control Standard	品質管理の基準
DCM		111052	Quality Finding	品質に関する所見
SNM3		M-78731	Radial scar	放射状硬化性病変 (放射状瘢痕)

Coding Scheme Designator	Coding Scheme Version	Code Value	Code Meaning English Language	Code Meaning Japanese Language
DCM		111053	Recommended Follow-up	経過観察の推奨
DCM		111054	Recommended Follow-up Date	推奨される経過観察日
DCM		111055	Recommended Follow-up Interval	推奨される経過観察間隔
SRT		F-01773	Regional calcification distribution	領域性
SRT		F-0172A	Removal of implant since previous mammogram	インプラントの除去
DCM		111056	Rendering Intent	結果表示するかどうか
SNM3		T-04020	Right breast	右：右乳房
SNM3		M-02100	Round shape	円形
SNM3		M-78060	Scar tissue	瘢痕組織
SRT		F-01712	Scattered fibroglandular densities	乳腺散在
SNM3		M-74220	Sclerosing adenosis	硬化性腺症
DCM		111057	Scope of Feature	特徴の範囲
SNM3		M-85023	Secretory (juvenile) carcinoma of the breast	分泌癌（若年性癌）：分泌性乳癌（若年性乳癌）
SRT		F-01774	Segmental calcification distribution	区域性
DCM		111099	Selected region	選択された領域
DCM		111058	Selected Region Description	選択領域の記述
SNM3		M-020F9	Shape	形状
DCM		111059	Single Image Finding	1画像の所見
SNM3		D0-00050	Skin lesion	皮膚病変
SRT		F-01799	Skin retraction of breast	乳房の皮膚陥凹
SRT		F-0179A	Skin thickening of breast	乳房の皮膚肥厚
DCM		111218	Software failure	ソフトウェアの故障
SRT		P5-B3402	Spatial collocation analysis	空間的なデータ対応付け解析
SRT		P5-B3404	Spatial proximity analysis	空間的なデータ近接判定解析
SRT		F-01745	Spiculated lesion	スピキュラを伴う
SNM3		R-102D7	Spot compression	スポット圧迫撮影 (S)
DCM		111136	Spot magnification view(s)	拡大スポット撮影 (V)

<b>Coding Scheme Designator</b>	<b>Coding Scheme Version</b>	<b>Code Value</b>	<b>Code Meaning English Language</b>	<b>Code Meaning Japanese Language</b>
DCM		111340	Squamous cell carcinoma of the nipple	乳頭の扁平上皮癌
SNM3		A-13600	Staple	ステープル
DCM		111060	Study Date	検査日
DCM		111061	Study Time	検査時刻
SRT		F-0178D	Subareolar position	乳輪下
DCM		111222	Succeeded	成功
DCM		111062	Successful Analyses	解析の成功
DCM		111063	Successful Detections	検出の成功
DCM		111146	Suggestive of malignancy – take appropriate action	悪性—適切な処置が必要 (T)
DCM		111065	Summary of Analyses	解析の要約
DCM		111064	Summary of Detections	検出の要約
SNM3		A-13510	Suture material	縫合 ; 縫合材料
DCM		111155	Target content items are related contra-laterally	Target content itemsは対側のそれらに関連している
DCM		111154	Target content items are related spatially	Target content itemsは空間的に関連している
DCM		111153	Target content items are related temporally	Target content itemsは時間的に関連している
DCM		111194	Technical factors missing	撮影条件がない
SRT		P5-B3406	Temporal correlation	経時的相関
SRT		F-01798	Trabecular thickening of breast	乳房の梁柱の肥厚
SNM3		M-82113	Tubular adenocarcinoma	管状癌
SNM3		M-82110	Tubular adenoma	管状腺腫
SRT		F-01797	Tubular density	管状影
SRT		P5-B0099	Ultrasound procedure	超音波検査手技 (U)
DCM		111211	Under exposed	露光不足
DCM		111221	Unknown failure	原因不詳の故障
DCM		111176	Unspecified	非特定の物質
DCM		111235	Unusable — Quality renders image unusable	使用不可—画像構成の品質は使用不可である
SRT		T-04002	Upper inner quadrant of breast	内上部：乳房の内上部 1 / 4 (A領域)
SRT		T-04004	Upper outer quadrant of	外上部：乳房の外上部 1 / 4

Coding Scheme Designator	Coding Scheme Version	Code Value	Code Meaning English Language	Code Meaning Japanese Language
			breast	(C領域)
DCM		111236	Usable — Does not meet the quality control standard	使用可—品質管理の基準に達していない
DCM		111237	Usable — Meets the quality control standard	使用可—品質管理の基準に達している
SRT		F-0176B	Vascular calcification	血管
DCM		111066	Vertical Pixel Spacing	垂直方向のピクセル間隔
DCM		111179	View and Laterality Marker does not have approved codes	鉛マーカ―はFDAのコードがない
DCM		111178	View and Laterality Marker does not have both view and laterality	鉛マーカ―は撮影方向と左右の表示がない
DCM		111183	View and Laterality Marker is incorrect	鉛マーカ―は正しい位置にない
DCM		111177	View and Laterality Marker is missing	鉛マーカ―がみられない
DCM		111180	View and Laterality Marker is not near the axilla	鉛マーカ―は腋窩の近くにない
DCM		111184	View and Laterality Marker is off image	鉛マーカ―がフィルム外である
DCM		111182	View and Laterality Marker is partially obscured	鉛マーカ―は一部覆い隠されている
DCM		111298	Virginal hyperplasia	若年性過形成
UCUM	1.4	wk	Week	週
UCUM	1.4	a	Year	年

**Annex G English Code Meanings of Selected Codes (Normative)**

<b>Coding Scheme Designator (0008,0102)</b>	<b>Coding Scheme Version</b>	<b>Code Value (0008,0100)</b>	<b>Code Meaning (0008,0104)</b>
UCUM		1	unary
			no units
			ratio
SNM3		C-10520	Carbon dioxide, NOS
			Carbon dioxide gas
SNM3		C-21005	Ethanol
			Ethyl alcohol
SNM3		C-81100	Hypotensive agent, NOS
			Antihypertensive agent, NOS
			Antihypertensive drug, NOS
SNM3		C-A7400	Thrombolytic agent, NOS
			Fibrinolytic agent, NOS
SNM3		C-A7440	Injectable fibrinolysin
			Injectable plasmin
SNM3		C-B0300	Contrast agent, NOS
			Radiographic contrast agent, NOS
SNM3		C-B1091	Iodohippurate I <sup>131</sup> sodium
			Iodine <sup>131</sup> hippuran
SNM3		C-B1109	Iodine <sup>131</sup> polyvinylpyrrolidone
			Iodine <sup>131</sup> PVP
SNM3		C-B1225	Technetium Tc <sup>99</sup> N-substituted iminodiacetate
			Tc <sup>99</sup> labeled HIDA
SNM3		D3-40208	Congenital pulmonary arteriovenous fistula
			Congenital coronary artery fistula to pulmonary artery
SRT		D4-33142	Pulmonary artery conduit
			Congenital pulmonary artery conduit
SRT		D4-33512	Pulmonary vein confluence
			Congenital pulmonary vein confluence
SRT		D4-33514	Pulmonary venous atrium
			Congenital pulmonary venous atrium
SRT		D4-33516	Systemic venous atrium
			Congenital systemic venous atrium
SNM3		R-10206	Antero-posterior
			AP
SNM3		R-10214	Postero-anterior

			PA
SNM3		R-10246	Oblique axial
			Oblique caudo-cranial
			Oblique cranio-caudal
			Oblique transaxial
			Off-axial
			Off-axial projection
SNM3		R-10224	Medial-lateral
			Medio-lateral
SNM3		R-10230	Lateral-medial
			Latero-medial
SNM3		R-10232	Right lateral projection
			Left to right beam projection
SNM3		R-10236	Left lateral projection
			Right to left beam projection
SNM3		R-10242	caudad
			caudal projection
			cranio-caudal projection
SNM3		R-10244	cephalad
			cranial projection
			caudo-cranial projection
			from below
SNM3		R-4087B	transforaminal
			optic foramen projection
SNM3		G-A100	Right
			Right lateral
SNM3		G-A101	Left
			Left lateral
SNM3		G-A102	Bilateral
			Right and left
SNM3		G-A103	Unilateral
			One-sided
SNM3		G-A105	Anterior
			Ventral
SNM3		G-A106	Posterior
			Dorsal
SNM3		G-A107	Cephalic
			Cephalad
			Rostral
			Cranial
SNM3		G-A108	Caudal
			Caudad

SNM3		G-A109	Medial
			Median
			Middle
SNM3		G-A10A	Mediolateral
			Midline
SNM3		G-A112	External
			Outer
SNM3		G-A113	Internal
			Inner
SNM3		G-A115	Inferior
			Lower
SNM3		G-A116	Superior
			Upper
SNM3		G-A138	Coronal
			Frontal
SNM3		G-A140	Deep
			Profundis
SNM3		R-102CD	Sagittal Projection
			Lateral Projection
SNM3		G-4022	Contact with
			Direct contact
SNM3		G-A170	Hilar
			Hilus
SNM3		G-A174	Edge
			Along edge
SNM3		G-D105	Intracutaneous route
			Intradermal route
SNM3		G-D140	Oral route
			Peroral route
SNM3		G-D164	Vaginal route
			Per vagina
SNM3		P1-05535	Catheterization
			Insertion of catheter
SNM3		P1-30350	Atherectomy, NOS
			Removal of atherosclerotic plaque from artery, NOS
SNM3		T-15460	Wrist joint, NOS
			Joint of Wrist, NOS
SNM3		T-32000	Endo-cardiac
			Intra-cardiac
SNM3		T-41000	Endo-arterial
			Intra-arterial
SNM3		T-46010	Innominate artery



			Brachiocephalic artery
			Brachiocephalic trunk
SNM3		T-48170	Internal jugular vein
			Vena jugularis interna
SNM3		T-48620	Innominate vein
			Brachiocephalic vein
SNM3		T-48810	Portal vein
			Vena portae
SNM3		T-D4450	Omental bursa
			Lesser peritoneal sac
LN		33068-8	Thoracic Area
			FTA
LN		33070-4	Inner Orbital Diameter
			IOD
LN		11727-5	Estimated Weight
			EFW
LN		11948-7	Fetal Heart Rate
			HR
LN		11778-8	Estimated Date of Delivery
			EDD
LN		11955-2	Last Menstrual Period
			LMP
LN		11979-2	Abdominal Circumference
			AC
LN		11818-2	Anterior-Posterior Abdominal Diameter
			APAD
LN		11820-8	Biparietal Diameter
			BPD
LN		11824-0	BPD area corrected
			BPDa
LN		11963-6	Femur Length
			FL
LN		11984-2	Head Circumference
			HC
LN		11851-3	Occipital-Frontal Diameter
			OFD
LN		11988-3	Thoracic Circumference
			TC
LN		11862-0	Tranverse Abdominal Diameter
			TAD
LN		11863-8	Trans Cerebellar Diameter
			TCD

LN		11864-6	Transverse Thoracic Diameter
			TTD
LN		11629-3	Outer Orbital Diameter
			OOD
LN		11863-8	Trans Cerebellar Diameter
			TDC
LN		11726-7	Peak Velocity
			Peak Systolic Velocity
SRT		G-A188	Mid-Longitudinal
			Mid
SRT		T-45170	Carotid Bulb
			Carotid Sinus
LN		8277-6	Body Surface Area
			BSA
LN		29462-9	Pulmonary-to-Systemic Shunt Flow Ratio
			Qp/Qs
SRT		R-42047	Antegrade Direction
			Antegrade Flow
SRT		R-42E61	Retrograde Direction
			Regurgitant Flow
LN		11957-8	Crown Rump Length
			CRL
SRT		P1-48501	Breast implantation
			Implant procedure
SRT		P1-48520	Removal of breast implant
			Explantation
SRT		D0-00165	Weal
			Hives
SRT		D7-90010	Disorder of breast implant
			Breast implant problem
SRT		D7-90530	Breast lump
			Lump or thickening
SRT		D7-90560	Peau d'orange surface of breast
			Peau d'orange
SRT		D7-90565	Bloody nipple discharge
			Bloody discharge
SRT		DD-66A67	Hemorrhage postprocedure
			Abnormal bleeding
SRT		DD-67700	Infection as complication of medical care
			Infection
SRT		F-01BF8	Ultrasound scan normal
			Normal; the finding is not seen sonographically

SRT		F-01E06	Indeterminate result
			Inconclusive
SRT		F-02B9B	Nottingham Combined Grade cannot be determined
			GX - grade cannot be assessed
SRT		F-8A057	Calcification of breast
			Calcifications
SRT		F-8A074	Discoloration of skin of breast
			Redness of skin
SRT		F-8A09C	Nipple problem
			Nipple abnormality
SRT		F-A2632	Persistent pain following procedure
			Unusual pain
SRT		F-A5581	Vasovagal attack
			Vasovagal reaction
SRT		G-F616	Nottingham Combined Grade I: 3-5 points
			G1 - Low combined histologic grade (favorable)
SRT		G-F617	Nottingham Combined Grade II: 6-7 points
			G2 - Intermediate combined histo grade (moderately favorable)
SRT		G-F618	Nottingham Combined Grade III: 8-9 points
			G3 - High combined histologic grade (unfavorable)
SRT		M-78280	Surgical scar
			Post-surgical scar
SRT		P1-03106	Computed tomography guided biopsy
			CT guided
SRT		P1-03107	Magnetic resonance imaging guided biopsy
			MRI guided
SRT		P1-03115	Ultrasound guided biopsy
			Ultrasound guided
SRT		P1-48011	Pre-biopsy localization of breast lesion
			Localization for surgical biopsy
SRT		P1-48142	Diagnostic aspiration of breast cyst
			Cyst aspiration
SRT		P1-48145	Fine needle aspiration of breast
			FNA - Fine needle aspiration
SRT		P1-48304	Core needle biopsy of breast
			Core biopsy
SRT		P1-4830F	Breast – surgical biopsy
			Surgical biopsy
SRT		P2-4A000	Examination of breast
			Clinical breast exam
SRT		P5-00032	Diagnostic radiography, stereotactic localization

			Stereotactic
SRT		P5-40030	Specimen radiography of breast Specimen imaging
SRT		P5-D0042	Radionuclide localization of tumor, limited area Scintimammography
SRT		R-20099	O/E – axillary lymphadenopathy Large axillary lymph nodes
SRT		R-207D7	O/E - Breast lump palpated Palpable abnormality
SRT		R-40FB9	Before procedure Pre-
SRT		R-41DDC	High risk tumor High risk
SRT		R-422A4	After procedure Follow-up
SRT		R-101BA	vessel lumen cross sectional area reduction lumen area stenosis
SRT		R-101BB	vessel lumen diameter reduction lumen diameter stenosis
SRT		P5-B0700	Ultrasonic guidance procedure Ultrasound guided
SRT		F-01711	Almost entirely fat Almost entirely fat (<= 10% fibroglandular)
SRT		F-01712	Scattered fibroglandular densities Scattered fibroglandular tissue (11% - 50% fibroglandular)
SRT		F-01713	Heterogeneously dense Heterogeneously dense (51% - 75% fibroglandular)
SRT		F-01714	Extremely dense Extremely dense (greater than 75% fibroglandular)
SRT		F-0176F	Heterogeneous calcification Coarse heterogeneous calcification
SRT		F-01792	Focal asymmetric breast tissue Focal asymmetry
SRT		F-01793	Asymmetric breast tissue Global asymmetry
SRT		F-01797	Tubular density Asymmetric tubular structure/solitary dilated duct
SRT		M-85002	Intraductal carcinoma, non-infiltrating DCIS
SRT		P0-009B4	Evaluation procedure Clinical evaluation
SRT		P5-D0061	Radioisotope scan of lymphatic system

			Lymphoscintigraphy
SNM3		A-25612	Embolization coil
			Gianturco coil
SNM3		T-46010	Brachiocephalic artery
			Brachiocephalic trunk
			Innominate artery

**Annex H Code Meanings of LOINC Codes in DCMR**

<b>Coding Scheme Designator (0008,0102)</b>	<b>Code Value (0008,0100)</b>	<b>Code Meaning (0008,0104)</b>
LN	11522-0	Echocardiography Report
LN	11525-3	Ultrasound Obstetric and Gyn Report
LN	11528-7	Radiology Report
LN	11538-6	CT Chest Report
LN	11539-4	CT Head Report
LN	11540-2	CT Abdomen Report
LN	11541-0	MRI Head Report
LN	18745-0	Cardiac Catheterization Report
LN	18747-6	CT Report
LN	18748-4	Diagnostic Imaging Report
LN	18755-9	MRI Report
LN	18756-7	MRI Spine Report
LN	18757-5	Nuclear Medicine Report
LN	18758-3	PET Scan Report
LN	18760-9	Ultrasound Report
LN	33065-4	Ectopic Pregnancies
LN	33066-2	Estimated LMP by EDD
LN	33067-0	Conception Date
LN	33068-8	Thoracic Area
LN	33069-6	Nuchal Translucency
LN	33070-4	Inner Orbital Diameter
LN	33071-2	Spine Length
LN	33072-0	AC, ASUM 2000
LN	33073-8	AC, Hansmann1985
LN	33074-6	AC, Lessoway 1998
LN	33075-3	AC, Mertz 1988
LN	33076-1	AC, Shinozuka 1996
LN	33077-9	A-P Abdominal Diameter, Lessoway 1998
LN	33078-7	AxT, Shinozuka 1996
LN	33079-5	BPD, ASUM 1989
LN	33080-3	BPD, Lessoway 1998
LN	33081-1	BPD, Mertz 1988
LN	33082-9	BPD, Osaka 1989

LN	33083-7	BPD, Rempen 1991
LN	33084-5	BPD, Shinozuka 1996
LN	33085-2	BPD, Tokyo 1986
LN	33086-0	BPD-oi, Chitty 1997
LN	33087-8	BPD-oo, Chitty 1997
LN	33088-6	Clavical length, Yarkoni 1985
LN	33089-4	CRL, ASUM 1991
LN	33090-2	CRL, ASUM 2000
LN	33091-0	CRL, Daya 1993
LN	33092-8	CRL, Jeanty 1982
LN	33093-6	CRL, Osaka 1989
LN	33094-4	CRL, Rempen 1991
LN	33095-1	CRL, Shinozuka 1996
LN	33096-9	CRL, Tokyo 1986
LN	33097-7	Fibula, Jeanty 1983
LN	33098-5	FL, Chitty 1997
LN	33099-3	FL, Jeanty 1982
LN	33100-9	FL, Lessoway 1998
LN	33101-7	FL, Osaka 1989
LN	33102-5	FL, Shinozuka 1996
LN	33103-3	FL, Tokyo 1986
LN	33104-1	GS, Daya 1991
LN	33105-8	GS, Hansmann 1979
LN	33106-6	GS, Hansmann 1982
LN	33107-4	GS, Nyberg 1992
LN	33108-2	GS, Tokyo 1986
LN	33109-0	HC, ASUM 2000
LN	33110-8	HC measured, Chitty 1997
LN	33111-6	HC derived, Chitty 1997
LN	33112-4	HC, Hansmann 1985
LN	33113-2	HC, Jeanty 1982
LN	33114-0	HC, Lessoway 1998
LN	33115-7	HC Merz, 1988
LN	33116-5	Humerus Length, ASUM 2000
LN	33117-3	Humerus Length, Osaka 1989
LN	33118-1	Length of Vertebra, Tokyo 1986
LN	33119-9	OFD, ASUM 2000
LN	33120-7	OFD, Hansmann 1986
LN	33121-5	OFD, Lessoway 1998
LN	33122-3	IOD, Mayden 1982

LN	33123-1	IOD, Trout 1994
LN	33124-9	OOD, Mayden, 1982
LN	33125-6	OOD, Trout 1994
LN	33126-4	Radius, Jeanty 1983
LN	33127-2	Spine Length, Tokyo, 1989
LN	33128-0	TAD, Eriksen 1985
LN	33129-8	TAD Hansmann, 1979
LN	33130-6	TAD, Tokyo 1986?
LN	33131-4	ThC, Chitkara 1987
LN	33132-2	TCD, Chitty 1994
LN	33133-0	TCD, Goldstein 1987
LN	33134-8	TCD, Hill 1990
LN	33135-5	TCD, Nimrod 1986
LN	33136-3	Transverse Thoracic Diameter, Hansmann 1985
LN	33137-1	Transverse Thoracic Diameter, Lessoway 1998
LN	33138-9	Fetal Trunk Cross-Sectional Area, Osaka 1989
LN	33139-7	EFW by BPD, TTD, Hansmann 1986
LN	33140-5	EFW by BPD, FTA, FL, Osaka 1990
LN	33141-3	EFW1 by Shinozuka 1996
LN	33142-1	EFW2 by Shinozuka 1996
LN	33143-9	EFW3 by Shinozuka 1996
LN	33144-7	EFW by BPD, APAD, TAD, FL, Tokyo 1987
LN	33145-4	AC by GA, ASUM 2000
LN	33146-2	AC by GA, Hadlock 1984
LN	33147-0	AC (measured) by GA, Chitty 1994
LN	33148-8	AC by GA, Merz 1988
LN	33149-6	AC by GA, Shinozuka 1996
LN	33150-4	AxT by GA, Shinozuka 1996
LN	33151-2	BPD by GA, ASUM 2000
LN	33152-0	BPD outer-outer by GA, Chitty 1994
LN	33556-2	BPD outer-inner by GA, Chitty 1994
LN	33153-8	BPD by GA, Jeanty 1982
LN	33154-6	BPD by GA, Merz 1988
LN	33155-3	BPD by GA, Rempen 1991
LN	33156-1	BPD by GA, Shinozuka 1996
LN	33157-9	Cephalic Index, by GA Chitty 1994
LN	33158-7	Cephalic Index by GA, Hadlock 1981
LN	33159-5	CRL by GA, ASUM 2000
LN	33160-3	CRL by GA, Rempen1991
LN	33161-1	CRL, by GA, Shinozuka 1996



LN	33162-9	EFW by GA, Hadlock 1991
LN	33163-7	EFW by GA, Hansmann 1986
LN	33164-5	Fibula by GA, by GA Jeanty 1983
LN	33165-2	FL by GA, ASUM 2000
LN	33166-0	FL by GA, Hadlock 1984
LN	33167-8	FL by GA, Chitty 1994
LN	33168-6	FL by GA, Jeanty 1982
LN	33169-4	FL by GA, Merz 1988
LN	33170-2	FL by GA, Shinozuka 1996
LN	33171-0	GS by GA, Rempen 1991
LN	33172-8	HC by GA, ASUM 2000
LN	33173-6	HC by GA, Hadlock 1984
LN	33174-4	HC derived by GA, Chitty 1994
LN	33175-1	HC by GA, Jeanty 1982
LN	33176-9	HC by GA, Merz 1988
LN	33177-7	Humerus Length by GA, ASUM 2000
LN	33178-5	OFD by GA, ASUM 2000
LN	33179-3	OFD by GA, Chitty 1994
LN	33180-1	Radius,by GA, Jeanty 1983
LN	33181-9	TCD by GA, Goldstein 1987
LN	33182-7	HC/AC by GA, Campbell 1977
LN	33183-5	FWP by GA, Hadlock 1991
LN	33184-3	FWP by GA, Williams, 1982
LN	33185-0	FWP by GA, Alexander, 1996
LN	33186-8	Male Singleton BWP by GA, Arbuckle 1993
LN	33187-6	Female Singleton BWP by GA, Arbuckle 1993
LN	33188-4	Female Twins BWP by GA, Arbuckle 1993
LN	33189-2	FWP by GA, Brenner 1976
LN	33190-0	FWP by MA, Hadlock 1985
LN	33191-8	APAD * TAD
LN	33192-6	Uterus Volume
LN	33196-7	Posterior Horn Lateral ventricular width
LN	33197-5	Anterior Horn Lateral ventricular width
LN	33198-3	BPD by GA, Hadlock 1984
LN	33199-1	Male Twins BWP by GA, Arbuckle 1993
LN	8302-2	Patient Height
LN	29463-7	Patient Weight
LN	11996-6	Gravida
LN	11977-6	Para
LN	11612-9	Aborta

LN	11878-6	Number of Fetuses
LN	11886-9	Gestational Age by ovulation date
LN	18185-9	Gestational Age
LN	11888-5	Composite Ultrasound Age
LN	11885-1	Gestational Age by LMP
LN	11727-5	Estimated Weight
LN	11767-1	EFW percentile rank
LN	11948-7	Fetal Heart Rate
LN	11778-8	Estimated Date of Delivery
LN	11779-6	EDD from LMP
LN	11781-2	EDD from average ultrasound age
LN	11780-4	EDD from ovulation date
LN	11955-2	Last Menstrual Period
LN	11976-8	Ovulation date
LN	11947-9	HC/AC
LN	11871-1	FL/AC
LN	11872-9	FL/BPD
LN	11823-2	Cephalic Index
LN	11873-7	FL/HC
LN	11979-2	Abdominal Circumference
LN	11818-2	Anterior-Posterior Abdominal Diameter
LN	11819-0	Anterior-Posterior Trunk Diameter
LN	11820-8	Biparietal Diameter
LN	11824-0	BPD area corrected
LN	11860-4	Cisterna Magna
LN	11963-6	Femur Length
LN	11965-1	Foot length
LN	11984-2	Head Circumference
LN	11851-3	Occipital-Frontal Diameter
LN	11988-3	Thoracic Circumference
LN	11862-0	Tranverse Abdominal Diameter
LN	11863-8	Trans Cerebellar Diameter
LN	11864-6	Transverse Thoracic Diameter
LN	11853-9	Left Kidney thickness
LN	11834-9	Left Kidney length
LN	11825-7	Left Kidney width
LN	11855-4	Right Kidney thickness
LN	11836-4	Right Kidney length
LN	11827-3	Right Kidney width
LN	11966-9	Humerus length

LN	11967-7	Radius length
LN	11969-3	Ulna length
LN	11968-5	Tibia length
LN	11964-4	Fibula length
LN	11962-8	Clavicle length
LN	12171-5	Lateral Ventricular width
LN	11860-4	Cisterna Magna length
LN	12146-7	Nuchal Fold thickness
LN	11629-3	Outer Orbital Diameter
LN	11863-8	Trans Cerebellar Diameter
LN	12170-7	Width of Hemisphere
LN	11624-4	First Quadrant Diameter
LN	11626-9	Second Quadrant Diameter
LN	11625-1	Third Quadrant Diameter
LN	11623-6	Fourth Quadrant Diameter
LN	11957-8	Crown Rump Length
LN	11850-5	Gestational Sac Diameter
LN	11816-6	Yolk Sac length
LN	12164-0	Left Ovary Volume
LN	11840-6	Left Ovary Length
LN	11829-9	Left Ovary Width
LN	11857-0	Left Ovary Height
LN	12165-7	Right Ovary Volume
LN	11841-4	Right Ovary Length
LN	11830-7	Right Ovary Width
LN	11858-8	Right Ovary Height
LN	11961-0	Cervix Length
LN	12145-9	Endometrium Thickness
LN	11885-1	Gestational Age by LMP
LN	11884-4	Average Ultrasound Age
LN	11889-3	AC, Campbell 1975
LN	11892-7	AC, Hadlock 1984
LN	11893-5	AC, Jeanty 1984
LN	11900-8	BPD, Doubilet 1993
LN	11902-4	BPD, Hadlock 1984
LN	11903-2	BPD, Hansmann 1985
LN	33538-0	BPD, Hansmann 1986
LN	33539-8	BPD, Jeanty 1982
LN	11905-7	BPD, Jeanty 1984
LN	11906-5	BPD, Kurtz 1980

LN	11907-3	BPD, Sabbagha 1978
LN	11901-6	BPDa, Hadlock 1982
LN	11910-7	CRL, Hadlock 1992
LN	11911-5	CRL, Hansmann 1985
LN	11917-2	CRL, Jeanty 1984
LN	11913-1	CRL, Nelson 1981
LN	11914-9	CRL, Robinson 1975
LN	11918-0	Fibula, Merz 1987
LN	11920-6	FL, Hadlock 1984
LN	11921-4	FL, Hansmann 1985
LN	11922-2	FL, Hohler 1982
LN	33099-3	FL, Jeanty 1982
LN	11923-0	FL, Jeanty 1984
LN	33100-9	FL, Lessoway 1998
LN	11924-8	FL, Merz 1987
LN	33101-7	FL, Osaka 1989
LN	33102-5	FL, Shinozuka 1996
LN	33103-3	FL, Tokyo 1986
LN	11926-3	Foot Length, Mercer 1987
LN	33104-1	GS, Daya 1991
LN	33105-8	GS, Hansmann 1979
LN	33106-6	GS, Hansmann 1982
LN	11928-9	GS, Hellman 1969
LN	33107-4	GS, Nyberg 1992
LN	11929-7	GS, Rempen 1991
LN	11932-1	HC, Hadlock 1984
LN	11934-7	HC, Jeanty 1984
LN	11936-2	Humerus, Jeanty 1984
LN	11937-0	Humerus, Merz 1987
LN	33545-5	BD, Jeanty 1982
LN	11939-6	Radius, Merz 1987
LN	11941-2	Tibia, Jeanty 1984
LN	11944-6	Ulna, Jeanty 1984
LN	11945-3	Ulna, Merz 1987
LN	11756-4	EFW by AC, Campbell 1975
LN	11738-2	EFW by AC, BPD, Hadlock 1984
LN	11734-1	EFW by AC, BPD, FL, Hadlock 1984
LN	11735-8	EFW by AC, BPD, FL, Hadlock 1985
LN	11732-5	EFW by AC, BPD, FL, HC, Hadlock 1985
LN	11750-7	EFW by AC, FL, Hadlock 1984

LN	11751-5	EFW by AC, FL, Hadlock 1985
LN	11746-5	EFW by AC, FL, HC, Hadlock 1985
LN	11754-9	EFW by AC, HC Hadlock 1984
LN	11739-0	EFW by AC and BPD, Shepard 1982
LN	33130-6	TAD, Tokyo 1986
LN	33131-4	ThC, Chitkara 1987
LN	33537-2	AC, Jeanty 1982
LN	33538-0	BPD, Hansmann 1986
LN	33539-8	BPD, Jeanty 1982
LN	33540-6	CRL, Hansmann 1986
LN	33541-4	FL, Hansmann 1986
LN	33542-2	FL, Merz 1988
LN	33543-0	HC, Hansmann 1986
LN	33544-8	OFD, Hansmann 1985
LN	33545-5	BD, Jeanty 1982
LN	33147-0	AC (measured) by GA, Chitty 1994
LN	33546-3	AC (derived), Chitty 1994
LN	11665-7	Minimum Diastolic Velocity
LN	11653-3	End Diastolic Velocity
LN	11692-1	Time averaged peak velocity
LN	20352-1	Time averaged mean velocity
LN	11726-7	Peak Velocity
LN	12008-9	Pulsatility Index
LN	12023-8	Resistivity Index
LN	12144-2	Systolic to Diastolic Velocity Ratio
LN	20168-1	Acceleration time
LN	20217-6	Deceleration time
LN	20167-3	Acceleration Index
LN	33867-3	Velocity ratio
LN	33868-1	ICA/CCA velocity ratio
LN	33869-9	Renal Artery/Aorta velocity ratio
LN	8302-2	Patient height
LN	8277-6	Body Surface Area
LN	17977-0	Left Atrium Systolic Area
LN	17978-8	Mitral Valve A-Wave Peak Velocity
LN	17988-7	Right Atrium Systolic Area.
LN	17985-3	Left Atrium to Aortic Root Ratio
LN	17995-2	Thoracic Aorta Coarctation Systolic Peak Instantaneous Gradient
LN	17996-0	Aortic Valve Cusp Separation
LN	17998-6	Aortic Valve Regurgitant Diastolic Deceleration Time

LN	18006-7	Inferior Vena Cava Diameter
LN	18011-7	Aortic Arch Diameter
LN	18012-5	Ascending Aortic Diameter
LN	18013-3	Descending Aortic Diameter
LN	18015-8	Aortic Root Diameter
LN	18019-0	Left Pulmonary Artery Diameter
LN	18020-8	Main Pulmonary Artery Diameter
LN	18021-6	Right Pulmonary Artery Diameter
LN	18026-5	Left Ventricular End Diastolic Volume
LN	18030-7	Tricuspid Valve A Wave Peak Velocity
LN	18031-5	Tricuspid Valve E Wave Peak Velocity
LN	18035-6	Mitral Regurgitation dP/dt derived from Mitral Reg. velocity
LN	18037-2	Mitral Valve E-Wave Peak Velocity
LN	18038-0	Mitral Valve E to A Ratio
LN	18040-6	Mitral Valve E-F Slope by M-Mode
LN	18041-4	Aortic Valve Ejection Time
LN	18043-0	Left Ventricular Ejection Fraction
LN	18050-5	Inferior Vena Cava % Collapse
LN	18051-3	Left Ventricular Fractional Shortening
LN	18053-9	Left Ventricle Posterior Wall % Thickening
LN	18054-7	Interventricular Septum % Thickening
LN	18070-3	Right Atrium Systolic Pressure
LN	18071-1	Left Ventricular Isovolumic Relaxation Time
LN	18076-0	Left Ventricle Systolic Major Axis
LN	18077-8	Left Ventricle Diastolic Major Axis
LN	18087-7	Left Ventricle Mass
LN	18096-8	Pulmonic valve Area by continuity
LN	18118-0	LV Wall Motion Segmental Findings
LN	18139-6	Stage
LN	18148-7	Left Ventricular End Systolic Volume
LN	18152-9	Left Ventricle Posterior Wall Diastolic Thickness
LN	18153-7	Right Ventricle Anterior Wall Diastolic Thickness
LN	18154-5	Interventricular Septum Diastolic Thickness
LN	18155-2	Interventricular Septum to Posterior Wall Thickness Ratio
LN	18156-0	Left Ventricle Posterior Wall Systolic Thickness
LN	18157-8	Right Ventricular Anterior Wall Systolic Thickness
LN	18158-6	Interventricular Septum Systolic Thickness
LN	18179-2	Wall Segment
LN	20247-3	Peak Gradient
LN	11726-7	Peak Velocity

LN	20295-2	Time from Q wave to Pulmonic Valve Closes
LN	29436-3	Left Ventricle Internal End Diastolic Dimension
LN	29438-9	Left Ventricle Internal Systolic Dimension
LN	29449-6	Mitral Valve Regurgitant Volume by Proximal Isovelocity Surface Area Method
LN	29450-4	Pulmonary Vein Systolic Peak Velocity
LN	29451-2	Pulmonary Vein Diastolic Peak Velocity
LN	29452-0	Pulmonary Vein Systolic to Diastolic Ratio
LN	29453-8	Pulmonary Vein Atrial Contraction Reversal Peak Velocity
LN	29460-3	Thoracic Aorta Coarctation Systolic Peak Velocity
LN	29462-9	Pulmonary-to-Systemic Shunt Flow Ratio
LN	29463-7	Patient weight
LN	29469-4	Left Atrium Antero-posterior Systolic Dimension
LN	29471-0	Hepatic Vein Systolic Peak Velocity
LN	29472-8	Hepatic Vein Diastolic Peak Velocity
LN	29473-6	Hepatic Vein Systolic to Diastolic Ratio
LN	29474-4	Hepatic Vein Atrial Contraction Reversal Peak Velocity
LN	29486-8	Left Atrial Appendage Peak Velocity
LN	11793-7	Follicle Diameter
LN	10160-2	History of Medication Use
LN	11450-4	Problem List

**Annex I Relationship of Endoscopy Procedures to Anatomic Regions (Informative)**

The table in this Annex provides examples of the common nomenclature for the type of endoscopy performed, and the code value suggested for use for anatomic region in CID 4040.

<b>Coding Scheme Designator (0008,0102)</b>	<b>Code Value (0008,0100)</b>	<b>Code Meaning (0008,0104)</b>	<b>Example of the type of endoscopy for which this region is applicable (informative)</b>
SRT	T-D4000	Abdomen	Laparoscopy
SRT	T-59490	Anus, rectum and sigmoid colon	Rectosigmoidoscopy
SRT	T-60610	Bile duct	
SRT	T-74000	Bladder	Cystoscopy
SRT	T-DD123	Bladder and urethra	Panendoscopy (urethrocystoscopy)
SRT	T-26000	Bronchus	Bronchoscopy
SRT	T-83200	Cervix	Colposcopy
SRT	T-D3000	Chest	Thoracoscopy
SRT	T-DD163	Esophagus, stomach and duodenum	Upper gastrointestinal endoscopy
SRT	T-AB200	External auditory canal	Otoscopy
SRT	T-63000	Gall bladder	Laparoscopic cholecystectomy
SRT	T-D7000	Inguinal region	Endoscopic inguinal hernia repair
SRT	T-15001	Joint	Arthroscopy
SRT	T-71000	Kidney	Percutaneous renal endoscopy
SRT	T-D9200	Knee	Arthroscopy of knee
SRT	T-59000	Large intestine	Colonoscopy
SRT	T-24100	Larynx	Laryngoscopy
SRT	T-40230	Lumen of blood vessel	Endoluminal (intravascular) endoscopy
SRT	T-D3300	Mediastinum	Mediastinoscopy
SRT	T-2300C	Naso pharynx	Naso pharyngoscopy
SRT	T-22000	Paranasal sinus	Endoscopic sinus surgery
SRT	T-55002	Pharynx	Pharyngoscopy
SRT	T-20101	Pharynx and larynx	Laryngopharyngoscopy
SRT	T-59600	Rectum	Proctoscopy
SRT	T-D2220	Shoulder	Arthroscopy of shoulder
SRT	T-59470	Sigmoid colon	Sigmoidoscopy



SRT	T-11500	Spine	Spinal endoscopy
SRT	T-DD006	Trachea and bronchus	Tracheobronchoscopy
SRT	T-70010	Upper urinary tract	Percutaneous or retrograde ureteric and renal endoscopy
SRT	T-73800	Ureter	Percutaneous or retrograde ureteric endoscopy
SRT	T-88920	Uterus and fallopian tubes	Culdoscopy

## Annex J SNOMED DICOM Microglossary Retired Codes (Normative)

This Annex identifies coded terms specified in earlier versions of the Standard that were included in the SNOMED DICOM Microglossary. The Microglossary and these coded terms are retired. Some of the codes conflict with codes defined in SNOMED. Additionally, some SNOMED coded terms specified in earlier versions of the Standard have been retired and replaced by SNOMED to avoid ambiguities in concept, and are noted here as well.

Implementors of the Standard are cautioned that:

- some applications may continue to send retired codes with the meaning defined in this Annex
- the retired codes may be associated with coding scheme designator 99SDM or SNM3
- retired codes may be encountered in existing SOP Instances stored in archives
- applications receiving SOP Instances should continue to support retired codes with the meaning defined in this Annex
- some applications may not trigger expected behavior (e.g. hanging protocols, image processing) when receiving SOP Instances with the replacement codes
- DICOM applications and SOP Instances shall never use the retired codes with a meaning other than that defined in this Annex

### SNOMED DICOM Microglossary Retired Codes

Retired Code Value	Code Meaning	Replacement Code (SNOMED)	Notes
G-5190	Headfirst	F-10470	
G-5191	Feet-first	F-10480	
G-A11A	Mid-longitudinal	G-A188	
G-A11B	Parasagittal	G-A189	
G-A12A	Intraluminal	R-42142	
G-A16A	Capsule	G-A171	Replacement code has meaning "Capsular"
G-A16B	Lumen	T-D0048	
G-A16C	Contact	G-4022	Replacement code has meaning "Contact with"
G-A16D	Parenchyma	T-D0062	
R-102C9	Transthoracic	R-40885	
R-102CA	Lordotic	R-40799	
R-102CB	Transforaminal	R-4087B	
R-102CC	Transoral	G-D00B	

R-102CE	Transorbital	R-40554	
R-11300	Transverse	G-A117	
Y-X1770	Cranio-caudal exaggerated laterally	R-1024A	
Y-X1771	Cranio-caudal exaggerated medially	R-1024B	
T-D1217	Maxilla and mandible	T-D1213	Replacement code has meaning "Jaw Region"
T-D1480	Orbit	T-D0801	Replacement code has meaning "Orbital Region"
T-D6151	Uterus and fallopian tubes	T-88920	
G-0371	% Area Reduction	R-101BA	Lumen Area Stenosis
G-0372	% Diameter Reduction	R-101BB	Lumen Diameter Stenosis
G-C295	Route of Administration	G-C340	
G-D100	Route of Administration	G-C340	

## **Annex K      Relevant Patient Information Templates (Normative)**

The following templates are appropriate to use as Root templates for the Relevant Patient Information Query Service Class:

- TID 9007 General Relevant Patient Information.
- TID 9000 Relevant Patient Information for Breast Imaging.
- TID 9001 Gynecological History
- TID 9002 Medication, Substance, Environmental Exposure
- TID 9003 Previous Procedure
- TID 9004 Indicated Problem
- TID 9005 Risk Factor
- TID 9006 Obstetric History
- TID 3802 Cardiovascular Patient History.